

front view

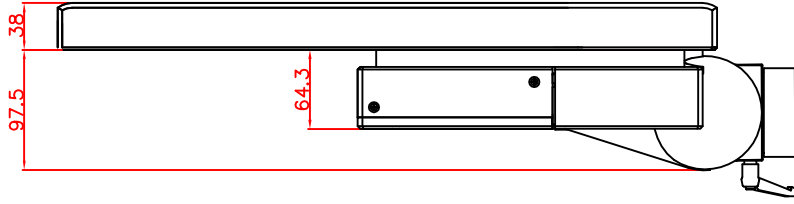

left view

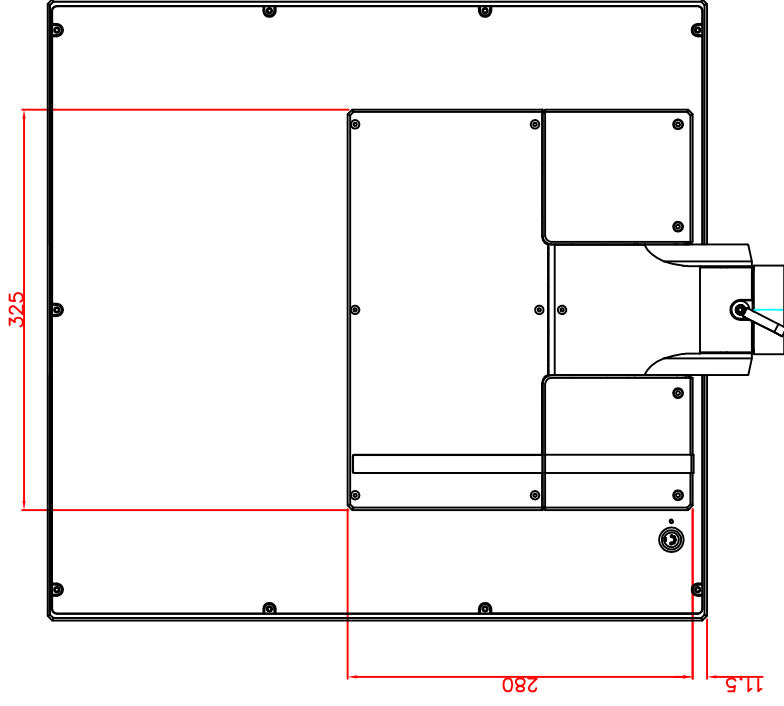

rear view

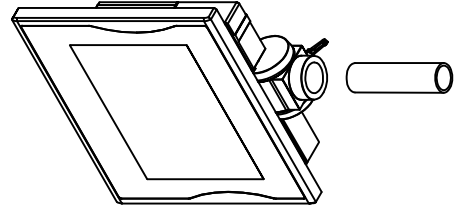

CP7233-0002-M163-E169
 Ø48 mm fixingtube
 main dimensions and fixing
 points
 dimensions in mm

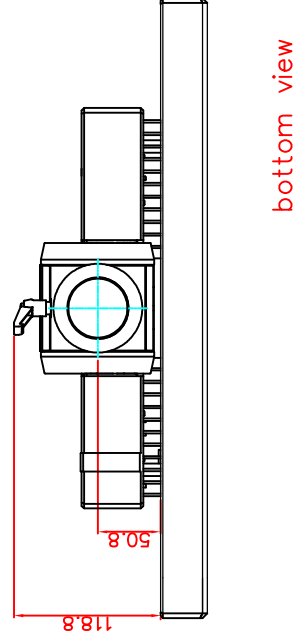
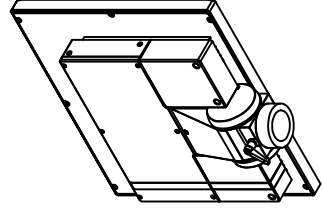

bottom view