

CP7103-0011-M150
mounting arm adapter
for Rolec Tara-48-60
146.025.016

main dimensions and fixing
points
dimensions in mm

4x Cheese head screw M5x20

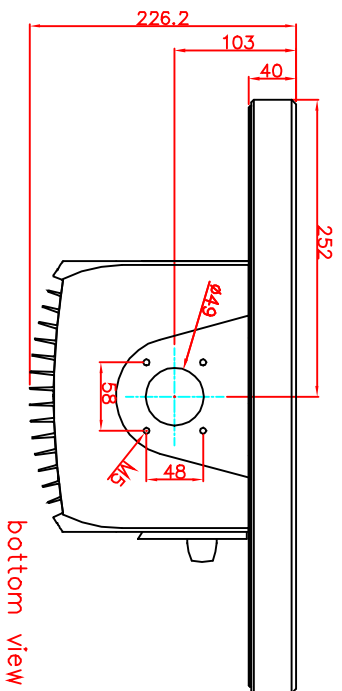
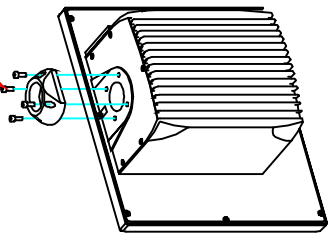

bottom view

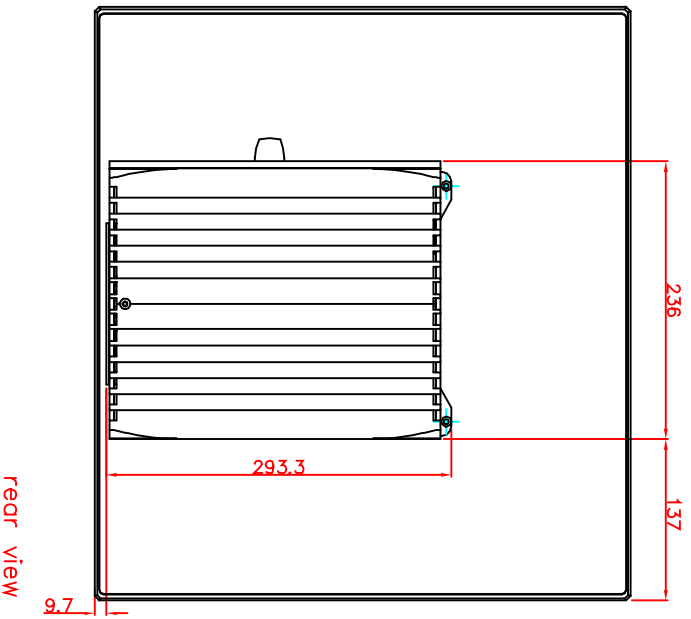

rear view

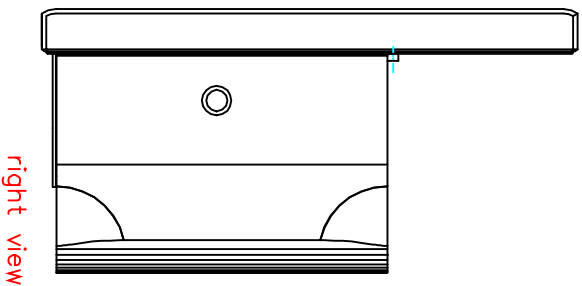

right view

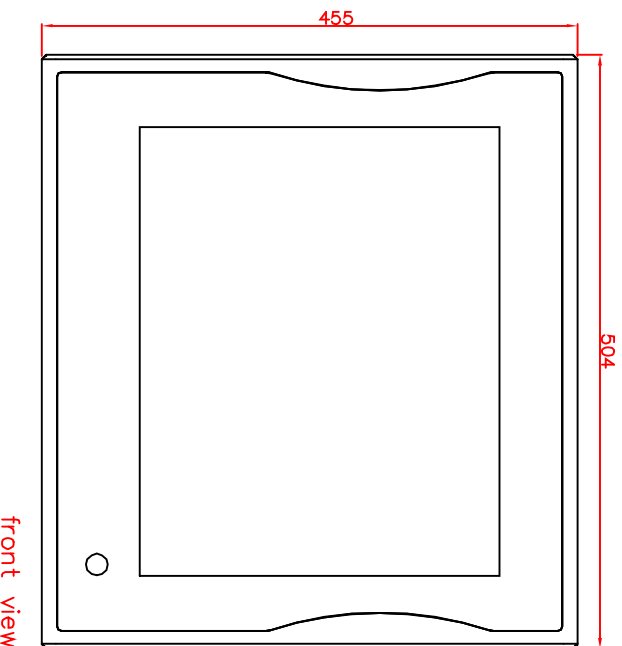

front view