

CP3215

main dimensions and
fixing points

dimensions in mm

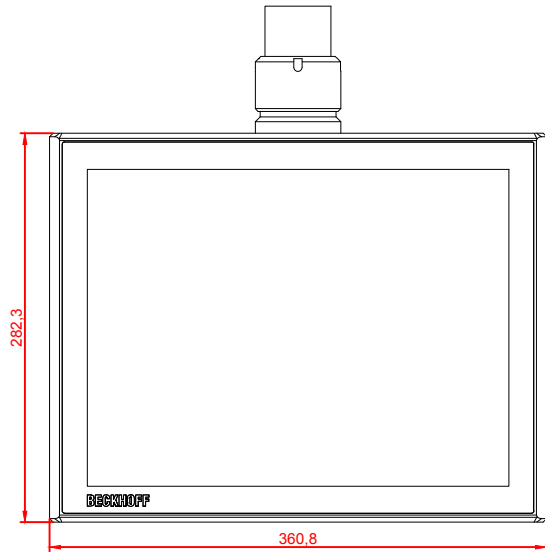

front view

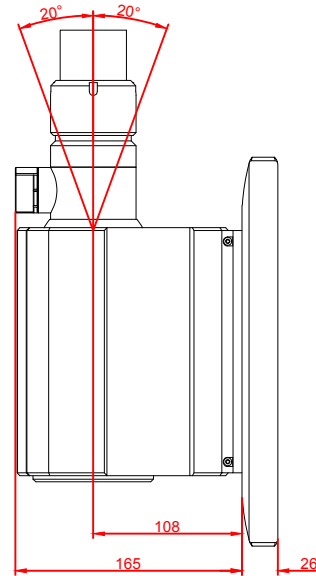

left view

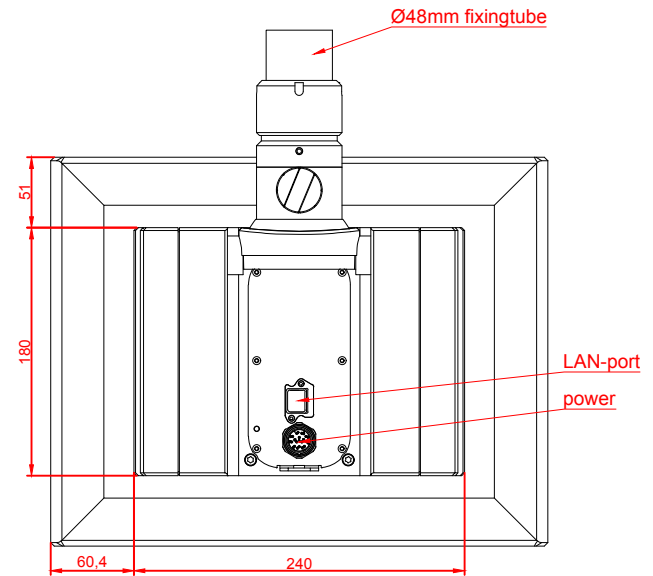

rear view

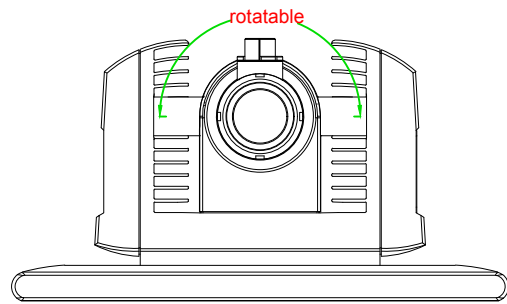

top view

