

bottom view

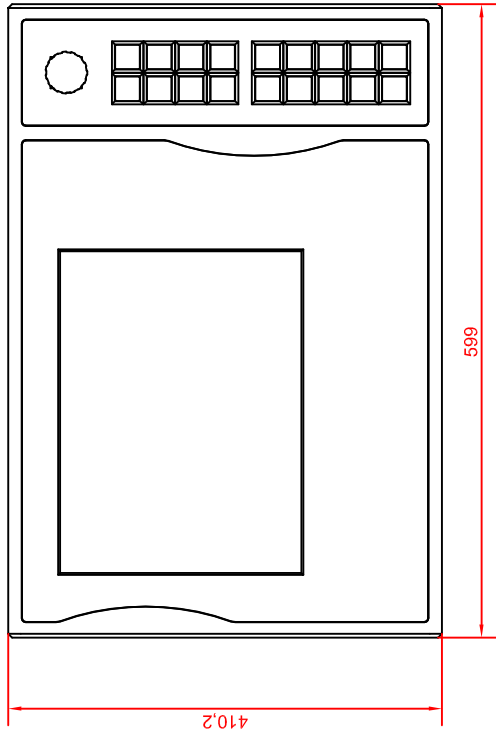

front view

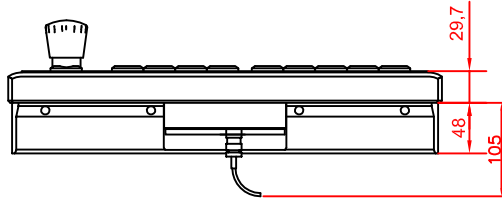

left view

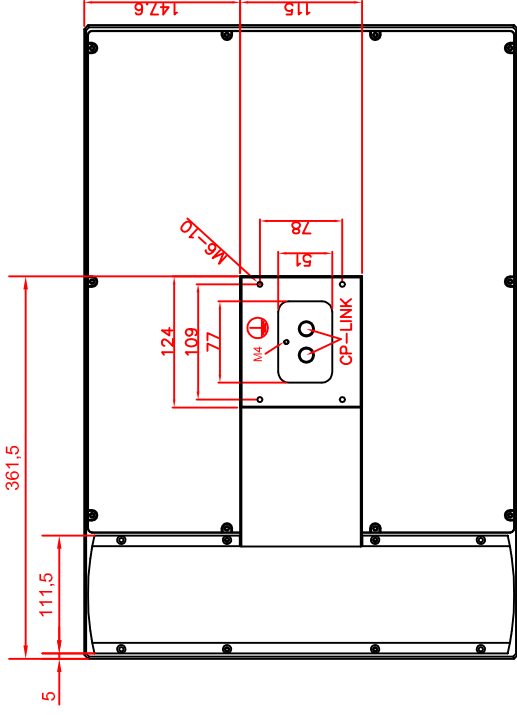

rear view

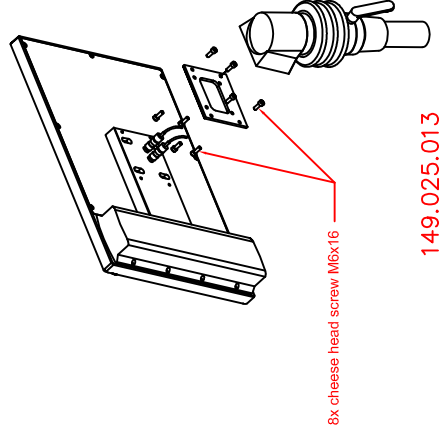

8x cheese head screw M6x16

149.025.013

CP7032-0001-E777  
arm adapter for  
Rolec - Tara - suspension adaption  
146.025.019

main dimensions and  
fixing points

dimensions in mm