

front view

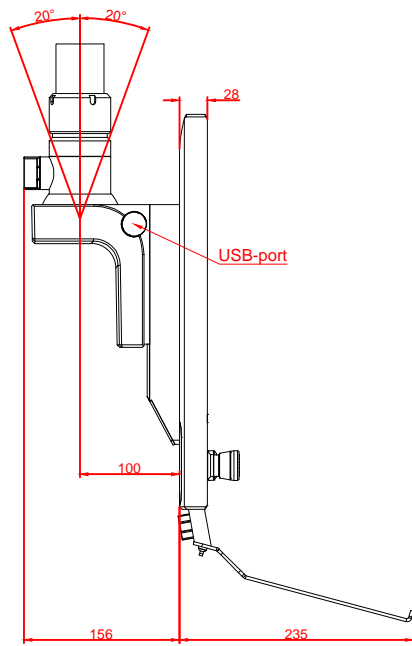

left view

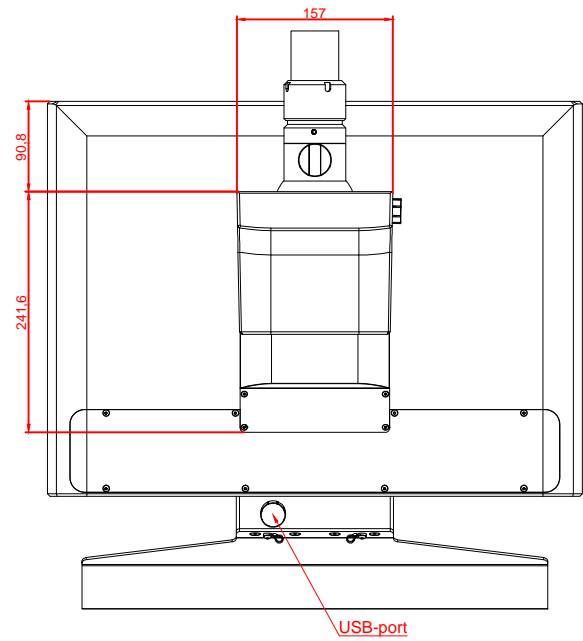

rear view

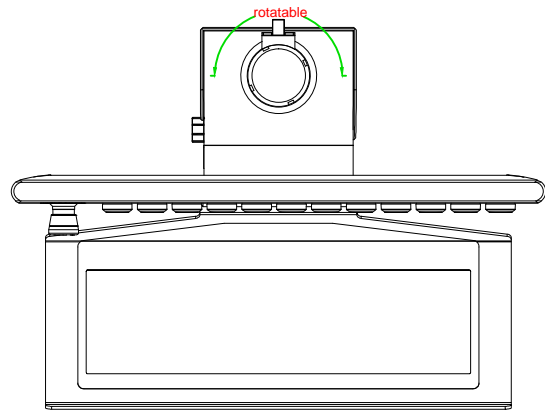

top view

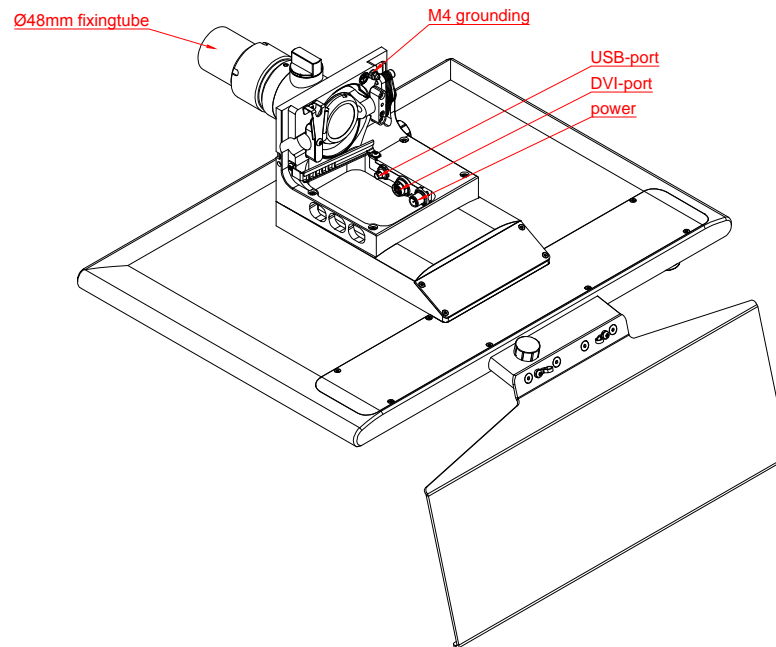

CP3921-G028-M752-E274-M406

main dimensions and
fixing points

dimensions in mm