

bottom view

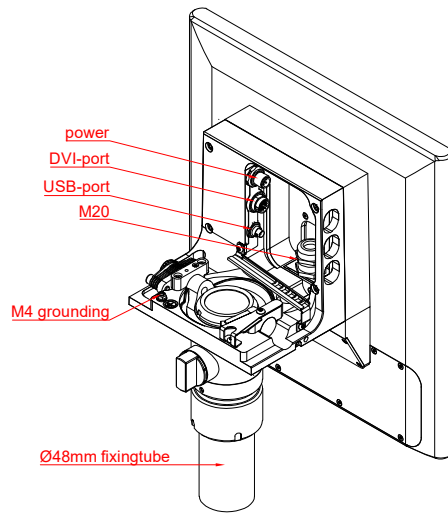

power
DVI-port
USB-port
M20
M4 grounding

Ø48mm fixingtube

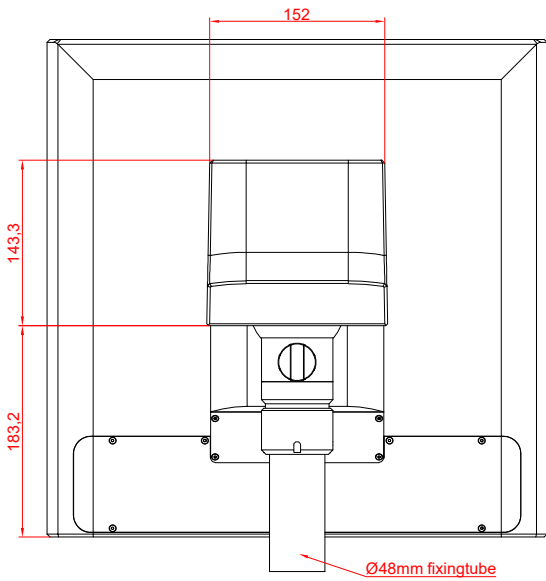

rear view

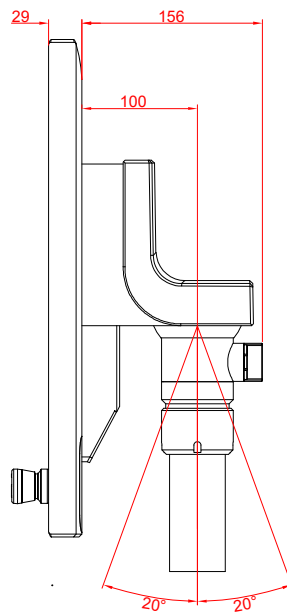

side view

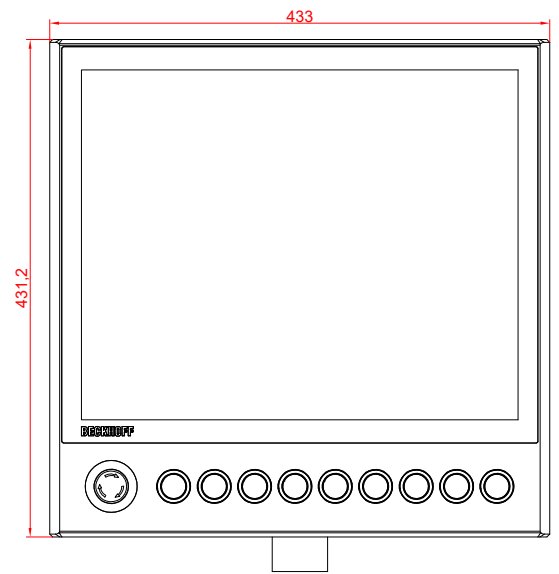

front view

CP3919-0000
with
C9900-G026
C9900-M753

main dimensions and
fixing points

dimensions in mm

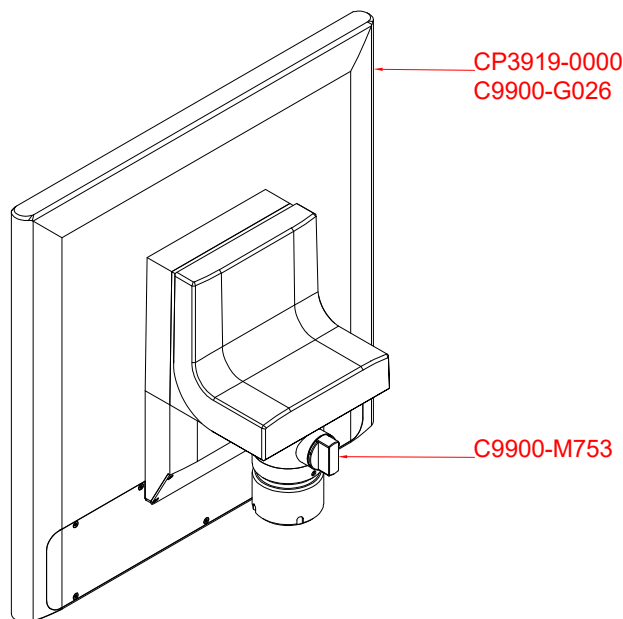

CP3919-0000
C9900-G026

C9900-M753