

CP3915-0010-M575-M751-E274

main dimensions and
fixing points

dimensions in mm

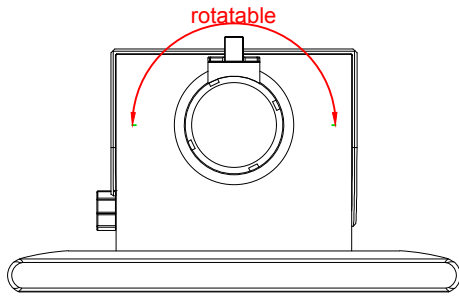

bottom view

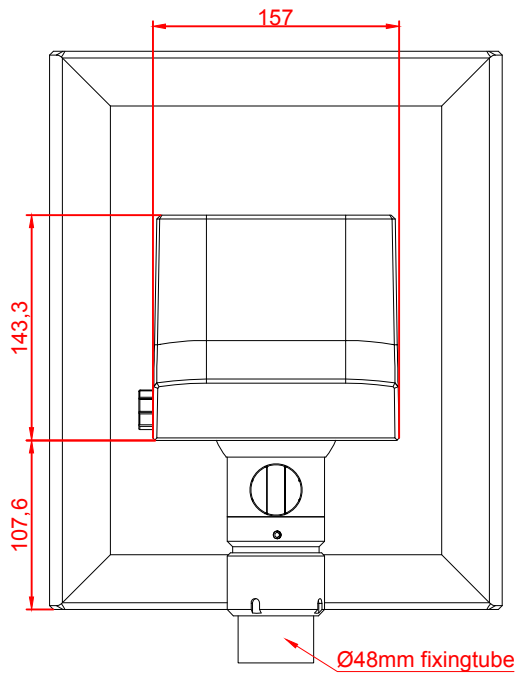
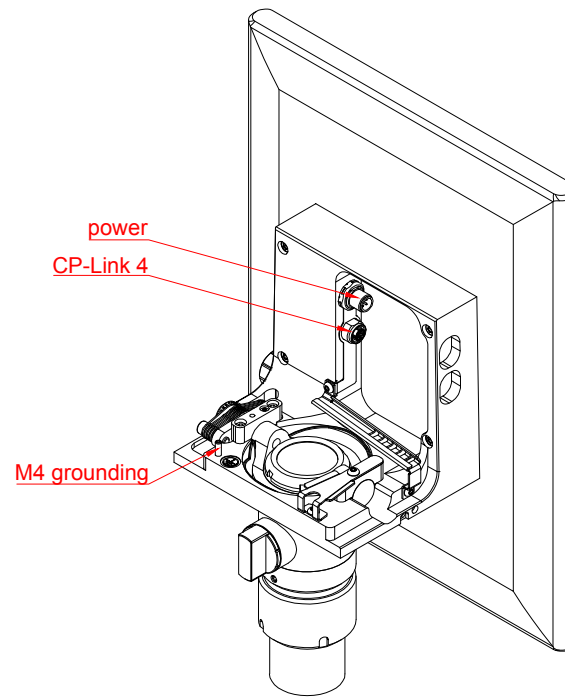

rear view

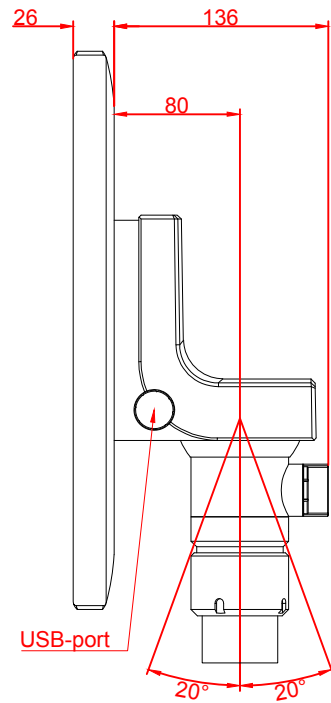

right view

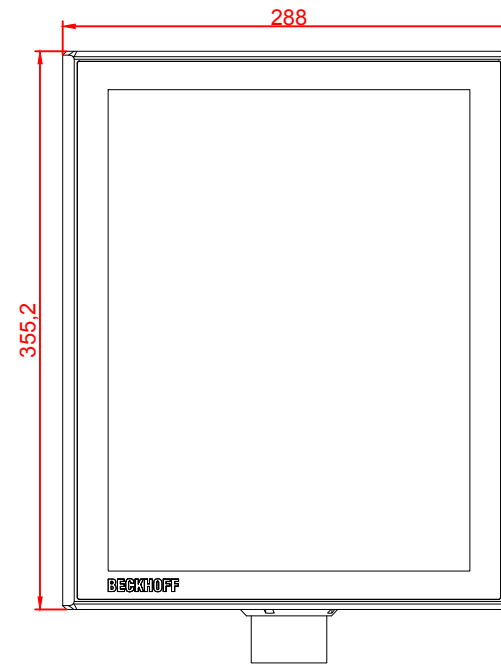

front view