



Installation and Operating instructions for
CP32xx
Multi-touch Panel PC

Version: 1.9
Date: 2019-10-09

BECKHOFF

Table of contents

1	Foreword	3
1.1	Notes on the Documentation	3
1.1.1	Liability Conditions	3
1.1.2	Trademarks	3
1.1.3	Patent Pending	3
1.1.4	Copyright	3
1.1.5	State at Delivery	3
1.1.6	Delivery conditions	3
1.2	Description of safety symbols	4
1.3	Basic safety measures	5
1.4	Operator's obligation to exercise diligence	6
1.4.1	National regulations	6
1.4.2	Procedure in the event of a fault	6
1.4.3	Operator requirements	6
2	Product Description	7
2.1	Product overview	7
2.2	Appropriate Use	9
2.3	Access to the connectors	9
2.4	Access to the memory device and the battery	10
2.4.1	Removing the Cover	10
2.4.2	Replacing the battery	11
2.5	Connections	12
2.5.1	Power Supply (X101)	12
2.5.2	Network Interface (X102)	13
2.5.3	Additional interfaces (optional)	13
2.5.4	Ground connection	13
2.6	Connection Cables	14
2.6.1	Connection Cables for the Power Supply, optional	14
2.6.2	Ethernet connection cables, optional	14
3	Installation	15
3.1	Transport and Unpacking	15
3.1.1	Transport	15
3.1.2	Unpacking	15
4	Mounting	16
4.1	Earthing measures	16
4.2	Mounting arm installation	17

4.2.1	Mounting the mounting arm tube	18
4.3	Power Supply of the Industrial PC	20
4.3.1	Beckhoff power supply technology	20
4.4	Connecting Power Supply	22
4.4.1	Cable Cross Sections	22
4.4.2	Check voltage rating and connect	22
4.4.3	Configuration for shutting down the PC	22
4.4.4	PC_ON and Power Status functions	22
4.4.5	Wiring diagram	23
4.5	Connecting the Panel PC	24
4.5.1	Connecting cables	24
4.5.2	Earthing measures	24
5	Operating Instructions	25
5.1	Switching the Panel PC on and off	25
5.1.1	Switching on	25
5.1.2	Shutting down and switching off	25
5.1.3	First switching on and driver installation	25
5.2	Operation	25
5.3	Servicing and maintenance	26
5.3.1	Cleaning	26
5.3.2	Maintenance	26
5.3.3	Replacing the battery of the motherboard	26
5.4	Emergency procedures	26
5.5	Shutting down	26
5.5.1	Disposal	26
6	UPS Software Components (optional)	27
6.1	Installation on the PC	27
6.2	Help files	27
7	Troubleshooting	28
8	Assembly dimensions	29
9	Technical Data	30
10	Appendix	31
10.1	Beckhoff Support and Service	31
10.1.1	Beckhoff branches and partner companies	31
10.1.2	Beckhoff company headquarters	31
10.2	Approvals for USA and Canada	32
10.3	FCC Approvals for the United States of America	32
10.4	FCC Approval for Canada	32

1 Foreword

1.1 Notes on the Documentation

This description is only intended for the use of trained specialists in control and automation engineering who are familiar with the applicable national standards. It is essential that the following notes and explanations are followed when installing and commissioning these components.

The responsible staff must ensure that the application or use of the products described satisfy all the requirements for safety, including all the relevant laws, regulations, guidelines and standards.

1.1.1 Liability Conditions

The documentation has been prepared with care. The products described are, however, constantly under development. For that reason the documentation is not in every case checked for consistency with performance data, standards or other characteristics. In the event that it contains technical or editorial errors, we retain the right to make alterations at any time and without warning. No claims for the modification of products that have already been supplied may be made on the basis of the data, diagrams and descriptions in this documentation.

All pictures shown in the documentation are exemplary. Illustrated configurations can differ from standard.

1.1.2 Trademarks

Beckhoff[®], TwinCAT[®], EtherCAT[®], Safety over EtherCAT[®], TwinSAFE[®], XFC[®] and XTS[®] are registered trademarks of and licensed by Beckhoff Automation GmbH.

Other designations used in this publication may be trademarks whose use by third parties for their own purposes could violate the rights of the owners.

1.1.3 Patent Pending

The EtherCAT Technology is covered, including but not limited to the following patent applications and patents: EP1590927, EP1789857, DE102004044764, DE102007017835 with corresponding applications or registrations in various other countries.

The TwinCAT Technology is covered, including but not limited to the following patent applications and patents: EP0851348, US6167425 with corresponding applications or registrations in various other countries.

1.1.4 Copyright

© Beckhoff Automation GmbH & Co. KG.

The reproduction, distribution and utilization of this document as well as the communication of its contents to others without express authorization are prohibited. Offenders will be held liable for the payment of damages. All rights reserved in the event of the grant of a patent, utility model or design.

1.1.5 State at Delivery





All the components are supplied in particular hardware and software configurations appropriate for the application. Modifications to hardware or software configurations other than those described in the documentation are not permitted, and nullify the liability of Beckhoff Automation GmbH & Co. KG.

1.1.6 Delivery conditions

In addition, the general delivery conditions of the company Beckhoff Automation GmbH & Co. KG apply.

1.2 Description of safety symbols

The following safety symbols are used in this operating manual. They are intended to alert the reader to the associated safety instructions.

 DANGER	<p>Acute risk of injury!</p> <p>If you do not adhere the safety advise adjoining this symbol, there is immediate danger to life and health of individuals!</p>
 WARNING	<p>Risk of injury!</p> <p>If you do not adhere the safety advise adjoining this symbol, there is danger to life and health of individuals!</p>
 CAUTION	<p>Hazard to individuals!</p> <p>If you do not adhere the safety advise adjoining this symbol, there is obvious hazard to individuals!</p>
 Attention	<p>Hazard to devices and environment</p> <p>If you do not adhere the notice adjoining this symbol, there is obvious hazard to materials and environment.</p>
 Note	<p>Note or pointer</p> <p>This symbol indicates information that contributes to better understanding.</p>

1.3 Basic safety measures

Before the Panel PC is switched off, software that is running must be properly closed. Otherwise it is possible that data on the storage medium is lost. Please read the section [Switching the Panel PC on and off](#).

 Warning	<p>Switch off all parts of the equipment, then uncouple the Panel PC</p> <p>Before opening the housing, and whenever the Panel PC is not being used for control purposes (such as during functional checks after a repair), all parts of the equipment must first be switched off, after which the Panel PC is to be disconnected from the equipment.</p>
---	--

Disconnect the device by unplugging the connectors on the rear side of the Panel PC. Items of equipment that have been switched off must be secured against being switched on again.

 Warning	<p>Do not exchange any parts when under power</p> <p>When components are being fitted or removed, the supply voltage must be switched off.</p> <p>Fitting work on the Panel PC can result in damage:</p> <ul style="list-style-type: none">• if metal objects such as screws or tools fall onto operating circuit boards• if connecting cables internal to the Panel PC are removed or inserted during operation.
---	---

1.4 Operator's obligation to exercise diligence

The operator must ensure that

- the product is only used as intended (see chapter [Product Description](#))
- the product is in a sound condition and in working order during operation
- the product is operated, maintained and repaired only by suitably qualified and authorized personnel
- the personnel is instructed regularly about relevant occupational safety and environmental protection aspects, and is familiar with the operating manual and in particular the safety notes contained herein
- the operation manual is in good condition and complete, and always available for reference at the location of the product.



Note

Do not open the housing of the Panel PC!

For technical support contact [Beckhoff Service](#).

1.4.1 National regulations

Depending on the type of machine and plant in which the Industrial PC is used, national regulations governing the controllers of such machines will apply, and must be observed by the operator. These regulations cover, amongst other things, the intervals between inspections of the controller. The operator must initiate such inspections in good time.

1.4.2 Procedure in the event of a fault

In the event of faults at the Industrial PC, the list in the section [Troubleshooting](#) can be used to determine the measures to be taken.

1.4.3 Operator requirements

Anyone who uses the Industrial PC must have read these operating instructions and must be familiar with all the functions of the software installed on the Industrial PC to which he has access.

2 Product Description

2.1 Product overview



The high-performance multi-touch Panel PC

With the CP32xx series, a high-end Panel PC with multi-touch can be used directly in the field. The devices in a slender aluminium housing feature complete IP 65 protection and are designed for mounting arm installation. The Panel PCs offer maximum computing power with processors of the latest generation, such as Intel® Celeron® or Core™ i3, i5, or i7.

A choice of seven different multi-touch TFT displays in sizes between 12-inch and 24-inch and 4:3, widescreen, landscape or portrait formats are available. Cooling is achieved by means of cooling fins on the outer wall as well as fans inside the closed housing. The operating temperature range is 0 to 45 °C.

The Panel PC features an integrated rotatable and tiltable mounting arm adapter for a 48 mm diameter mounting arm tube. There is a choice of attaching the mounting arm from above or below. The connecting cables are laid through the mounting arm. The Industrial PC connections (up to six) with IP 65 connectors are positioned in the large wiring space and are easily accessible. The wiring area can be opened easily without dismounting the device from the mounting arm, offering fast access to the IP 65 connectors for power supply, Ethernet and optional fieldbus, USB or RS232. Prefabricated cables in various lengths are available for all connections. The C32xx series Panel PCs are supplied with a 24 V power supply unit, optionally with integrated uninterruptible power supply (UPS). A battery pack can be connected externally and installed on a DIN rail in the control cabinet.

The CP32xx Panel PCs are equipped with one or two hard disks, SSDs or CFast cards or combinations thereof. With the on-board RAID controller, two same hard disks, SSDs or CFast cards can be mirrored. The data media and the lithium battery of the system clock are accessible from the rear under the cover.

There is a Mini PCI slot in the CP32xx. The Beckhoff Mini PCI Ethernet or fieldbus cards can be factory-fitted. NOVRAM up to 512 kB is also available in the form of an optional Mini PCI plug-in card for fail-safe data storage.

The multi-touch Panel PCs offer the following benefits:

- Industrial PC with Control Panel for mounting arm installation
- Multi-finger touch screen
- Rotatable and tiltable mounting arm adapter for Rittal and Rolec mounting arm systems with 48 mm tube
- Passive cooling through heat sink; internal fan for equal heat distribution to all the walls of the housing
- Wiring area for up to 6 IP65 connectors
- 1 slot for one 2½-inch hard disk or SSD and 1 slot for one CFast card
- Lithium battery of the system clock, changeable from outside
- Protection class IP65.

2.2 Appropriate Use

The CP32xx Panel PC is designed for industrial application in machine and plant engineering. In addition to the integrated PC, a TFT display with touch screen is accommodated in a slender aluminium housing. The Panel PC is designed for mounting arm installation.



Danger

Risk of explosion!

The Control Panel must not be used where there is a risk of explosion.

2.3 Access to the connectors

The connectors of the Panel PC are located at the rear side of the device behind a cover (1). To get access to the connectors, the cover has to be removed:

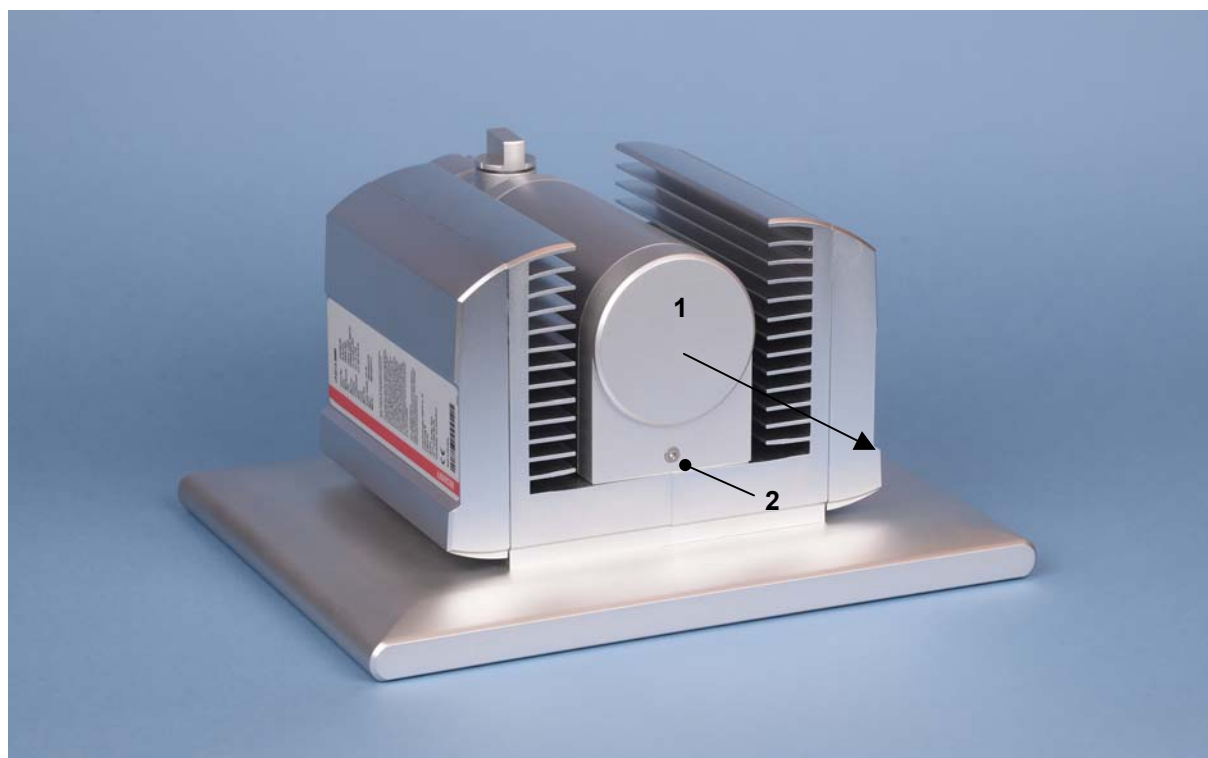

First loosen the fixing screw (2) with a star screwdriver Torx size 20. The cover now can be drawn off in direction of the arrow (see next picture).



After opening the connection area you have access to the connectors of the Panel PC. The cables with the connectors have to be pulled through the mounting arm tube before connecting them in the connection area.

The installation of the cover takes place in reverse order.

2.4 Access to the memory device and the battery

The slots for the hard disk and the battery are located behind the cover at the side of the Panel PC.

2.4.1 Removing the Cover

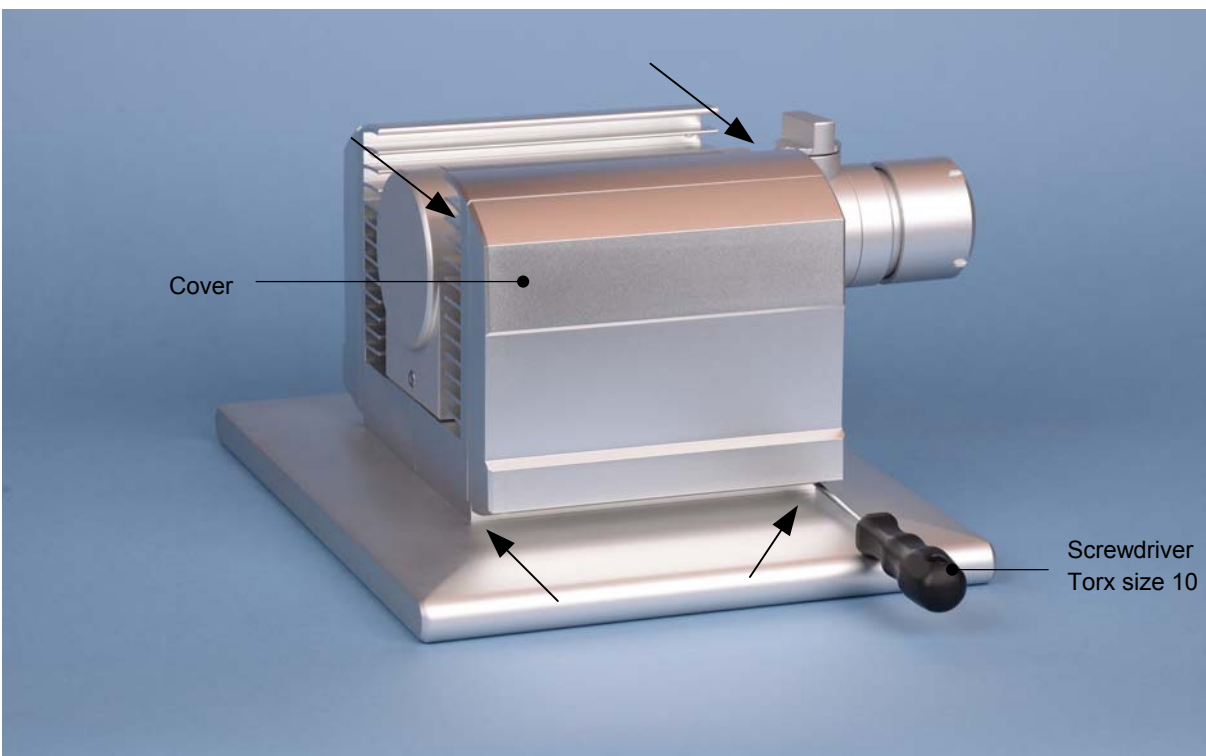

After unscrewing the four screws (see arrows) with a star screwdriver Torx size 10 the drive cover can be taken off.

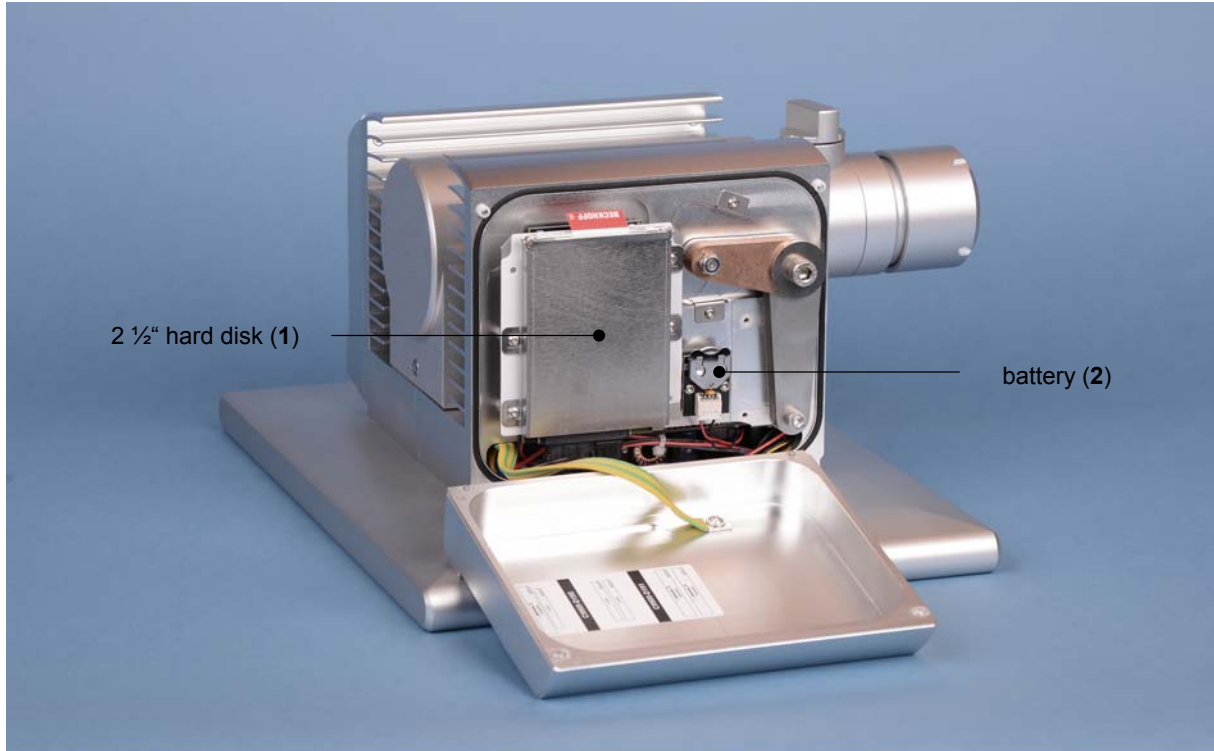

Removing the cover allows access to the hard-disk (1) and the lithium battery of the system clock (2). The hard-disk drive can now be pulled out. Here, changing the lithium battery is also possible.

The installation takes place in reverse order.

2.4.2 Replacing the battery

 WARNING	<p>Danger of Explosion!</p> <p>Replace battery only with the identical type or an alternative type recommended by the manufacturer. Notice correct polarity!</p>
---	---

Polarity of the battery:

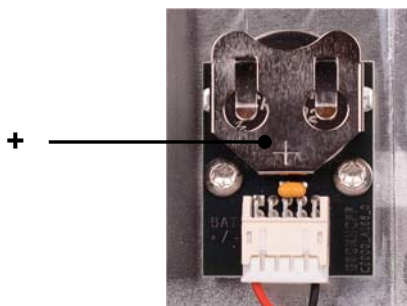

 WARNING	<p>Handling of Lithium Batteries</p> <p>Lithium Batteries should not be recharged, exposed to fire, opened and they should be protected against sunlight and moisture.</p>
---	---

2.5 Connections

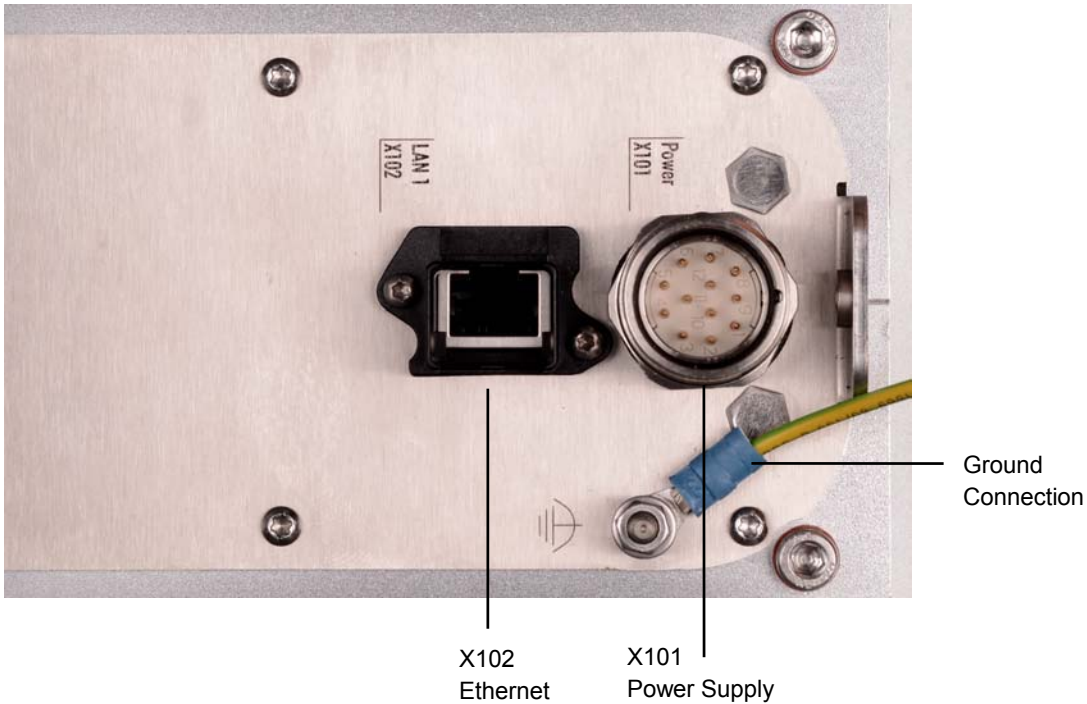

2.5.1 Power Supply (X101)

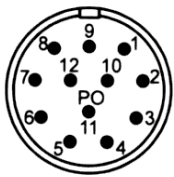

X101

Connector 12-pole Coninvers RC-12P1N1126000

View connector-sided

The power supply connection of the Panel PC and the connection with the UPS (optional) is established via the 12-pole power supply socket (**X101**). The protection class of the circular plug-in connector accords to the IP65-standard.

Wiring when using 8-core cables:

Pin	Wire	Function	Pin	Wire	Function	
1	1	-	Battery Pack (with UPS)	7	6	PC_ON
2	2	+		8	7	Power-Status
3	3	NC	9	-	NC	
4	ge/gn	⊕	10	-	NC	
5	4	-	24 V DC Power Supply	11	-	NC
6	5	+		12	-	NC

Wiring when using 12-core cables:

To connect the power supply and the battery pack, 2 wires per pin are used when using 12-core cables to halve the voltage drop across the cable.

Pin	Wire	Function	Pin	Wire	Function	
1	1, 8	-	Battery Pack (with UPS)	7	6	PC_ON
2	2, 9	+		8	7	Power-Status
3	3	NC	9	-	NC	
4	ge/gn	⊕	10	-	NC	
5	4, 10	-	24 V DC Power Supply	11	-	NC
6	5, 11	+		12	-	NC

2.5.2 Network Interface (X102)



X102

RJ-45-Connector (Ethernet 10/100/1000 Mbit)

The RJ-45 socket (**X 102**) enables connection of the Panel PC to a 10/100/1000 Mbit Ethernet network. The protection class accords to the IP65 standard.

Pin	Signal
Housing	Screen
1	TD +
2	TD -
3	RD +
4	NC
5	NC
6	RD -
7	NC
8	NC

For network connection following Harting Push Pull connector RJ45, 8-pole can be used (Connector RJ45 8-pole Harting Push Pull connector-set according to IEC24702, white No. 09 45 145 1500). The connector and special tools for the assembly are available via the company Harting <http://www.harting.de/> as well as different distributors.

2.5.3 Additional interfaces (optional)

There are notes at the Panel PC and in the connection area which provide information about the hardware configuration of the Panel PC at the time it was supplied.

2.5.4 Ground connection



The Panel PC is grounded via the screw connection.

 Note	<p>Malfunction possible with missing ground connection</p> <p>A proper ground connection of the device is absolutely necessary for the correct function of the touchscreen.</p>
--	--

2.6 Connection Cables

Optionally prefabricated connection cables for connecting the power supply as well as prefabricated Ethernet connection cables are available.

2.6.1 Connection Cables for the Power Supply, optional

The following connection cables for the power supply are available:

Connection Cables	Power supply cable with IP65 connector
C9900-K271	Power supply cable IP65 for CP32xx or CP72xx up to 19-inch display, length 5 m, assembled, M23 connector, screw type, 8 wires, second end open
C9900-K272	Power supply cable IP65 for CP32xx or CP72xx up to 19-inch display, length 10 m, assembled, M23 connector, screw type, 8 wires, second end open
C9900-K277	Power supply cable IP65 for CP32xx or CP72xx up to 19-inch display, length 20 m, assembled, M23 connector, screw type, 12 wires, second end open

2.6.2 Ethernet connection cables, optional

The following Ethernet connection cables are available:

Patch cable	Network cable with IP65 connector
C9900-K281	Network cable for CP32xx or CP72xx, length 3 m, assembled, Harting push-pull Ethernet connector IP65, second end RJ 45, IP20
C9900-K282	Network cable for CP32xx or CP72xx, length 5 m, assembled, Harting push-pull Ethernet connector IP65, second end RJ 45, IP20
C9900-K283	Network cable for CP32xx or CP72xx, length 10 m, assembled, Harting push-pull Ethernet connector IP65, second end RJ 45, IP20
C9900-K284	Network cable for CP32xx or CP72xx, length 15 m, assembled, Harting push-pull Ethernet connector IP65, second end RJ 45, IP20
C9900-K285	Network cable for CP32xx or CP72xx, length 20 m, assembled, Harting push-pull Ethernet connector IP65, second end RJ 45, IP20
C9900-K286	Network cable for CP32xx or CP72xx, length 30 m, assembled, Harting push-pull Ethernet connector IP65, second end RJ 45, IP20
C9900-K287	Network cable for CP32xx or CP72xx, length 40 m, assembled, Harting push-pull Ethernet connector IP65, second end RJ 45, IP20
C9900-K288	Network cable for CP32xx or CP72xx, length 50 m, assembled, Harting push-pull Ethernet connector IP65, second end RJ 45, IP20

3 Installation

3.1 Transport and Unpacking

The specified storage conditions must be observed (see chapter [Technical Data](#)).

3.1.1 Transport

Despite the robust design of the unit, the components are sensitive to strong vibrations and impacts. During transport, your device should therefore be protected from excessive mechanical stress. Therefore, please use the original packaging.

 Attention	Danger of damage to the unit If the device is transported in cold weather or is exposed to extreme variations in temperature, make sure that moisture (condensation) does not form on or inside the device.
---	---

Prior to operation, the unit must be allowed to slowly adjust to room temperature. Should condensation occur, a delay time of approximately 12 hours must be allowed before the unit is switched on.

3.1.2 Unpacking

Proceed as follows to unpack the unit:

1. Remove packaging.
2. Do not discard the original packaging. Keep it for future relocation.
3. Check the delivery for completeness by comparing it with your order.
4. Please keep the associated paperwork. It contains important information for handling the unit.
5. Check the contents for visible shipping damage.

If you notice any shipping damage or inconsistencies between the contents and your order, you should notify Beckhoff Service.

4 Mounting

The assemblage of the Panel PC occurs by using the mounting arm adapter.

The ambient conditions specified for operation must be observed (see chapter [Technical Data](#)).

Please note the following points during installation of the Panel PC:

- Position the Panel PC in such a way that reflections on the screen are avoided as far as possible.
- Use the position of the screen as a guide for the correct installation height; it should be optimally visible for the user at all times.
- The Panel PC should not be exposed to direct sunlight.



Attention

Avoid extreme environmental conditions

Extreme environmental conditions should be avoided as far as possible. Protect the Panel PC from dust, moisture and heat.

4.1 Earthing measures

Earthing connections dissipate interference from external power supply cables, signal cables or cables to peripheral equipment. Establish a low-impedance connection from the earthing point on the Panel PC housing (see chapter [Ground connection](#)) to the central earthing point on the control cabinet wall, in which the Panel PC is being installed.



Note

Malfunction possible with missing ground connection

A proper ground connection of the device is absolutely necessary for the correct function of the touchscreen.

4.2 Mounting arm installation

The mounting arm adapter is designed for Rittal- and Rolec mounting arm systems with 48 mm tubes. Depending on the order option C9900-M184 the mounting arm can be installed from the bottom:

Order Option	Description
C9900-M184	Mounting arm adapter for Panel PC CP32xx, for Rittal and Rolec mounting arm systems with 48 mm tube from bottom instead of from top.

 Note	Tolerance of the mounting arm tube diameter The mounting arm tube must have a diameter of 48 mm with a maximum tolerance of -0.1 mm/ +0.8 mm.
--	---

The mounting arm adapter enables to tilt the Panel PC at +/- 20° and to rotate it about +/- 165°.

 Note	Anti-twist protection The mounting arm adapter is fitted with an anti-twist safeguard to avoid over winding the Panel PC and damaging the connecting cables.
--	--

Tightening the locating screw with star knob (1) will protect the Panel PC against distortion. The hook wrench (2) and the 3 mm Allen key (3) are required for installation of the mounting arm tube at the mounting arm adapter.

Order Number	Description
C9900-Z263	Hook wrench size 58 – 62 for tying up the slotted nut of the mounting arm adapter C9900-M75x



4.2.1 Mounting the mounting arm tube

For mounting the mounting arm tube proceed as follows:

1. Unscrew the Allen locking screw (1) a few turns.

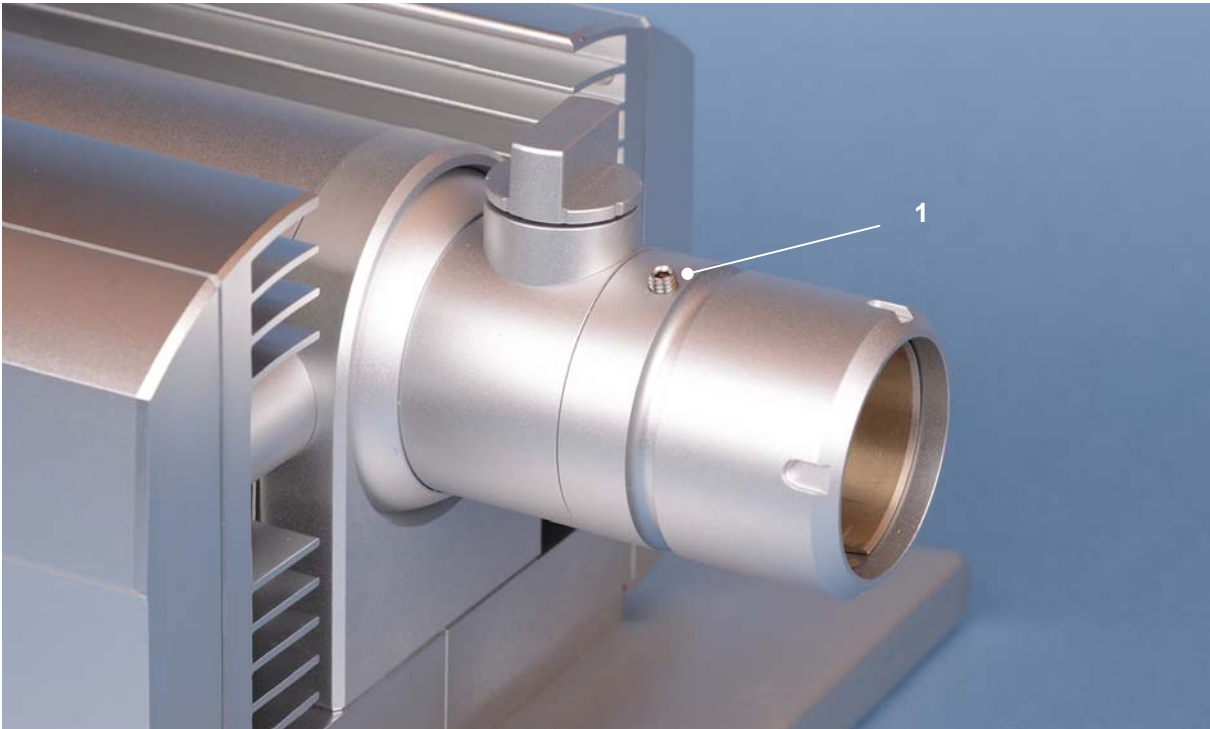

2. After feeding the connection cables of the Panel PC through the mounting arm tube, the mounting arm tube will be positioned into the mounting arm adapter



Attention

Insert the mounting arm tube all the way to the stop

The mounting arm tube has to extend into the adapter all the way to the stop, make sure the locking screw is turned out enough.

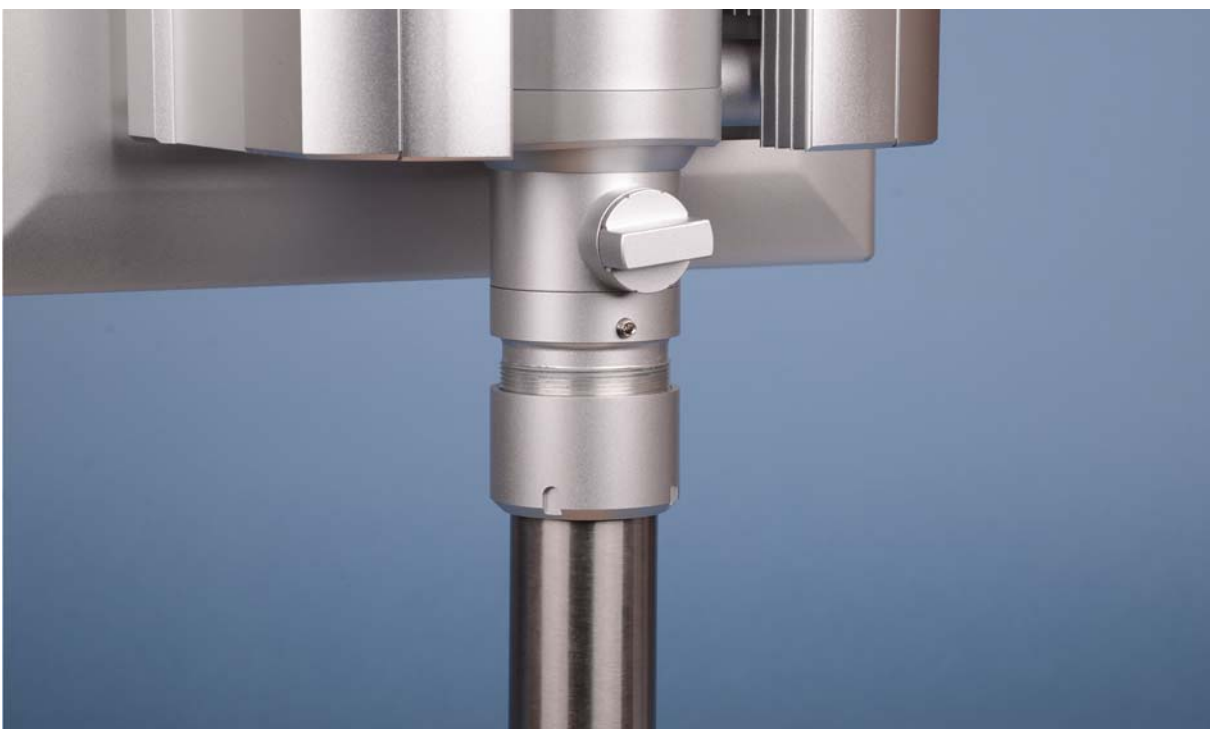

3. Tighten the Allen locking screw using the Allen key (2).





4. Now the screw cap is tightened carefully clockwise, using the hook wrench SW 58-62 (3).



4.3 Power Supply of the Industrial PC

The Industrial PC is fitted with a 24 V_{DC} power supply unit.

 Note	<p>Uninterruptible power supply (UPS)</p> <p>When the Industrial PC is provided with a power supply unit with integrated UPS (order option) you can realize an uninterruptible power supply (UPS) using the battery pack C9900-U330.</p>
--	---

 WARNING	<p>Danger of Explosion!</p> <p>Danger of Explosion if using other battery packs!</p>
---	---

4.3.1 Beckhoff power supply technology

Example: Schematic diagram of power supply unit wirings

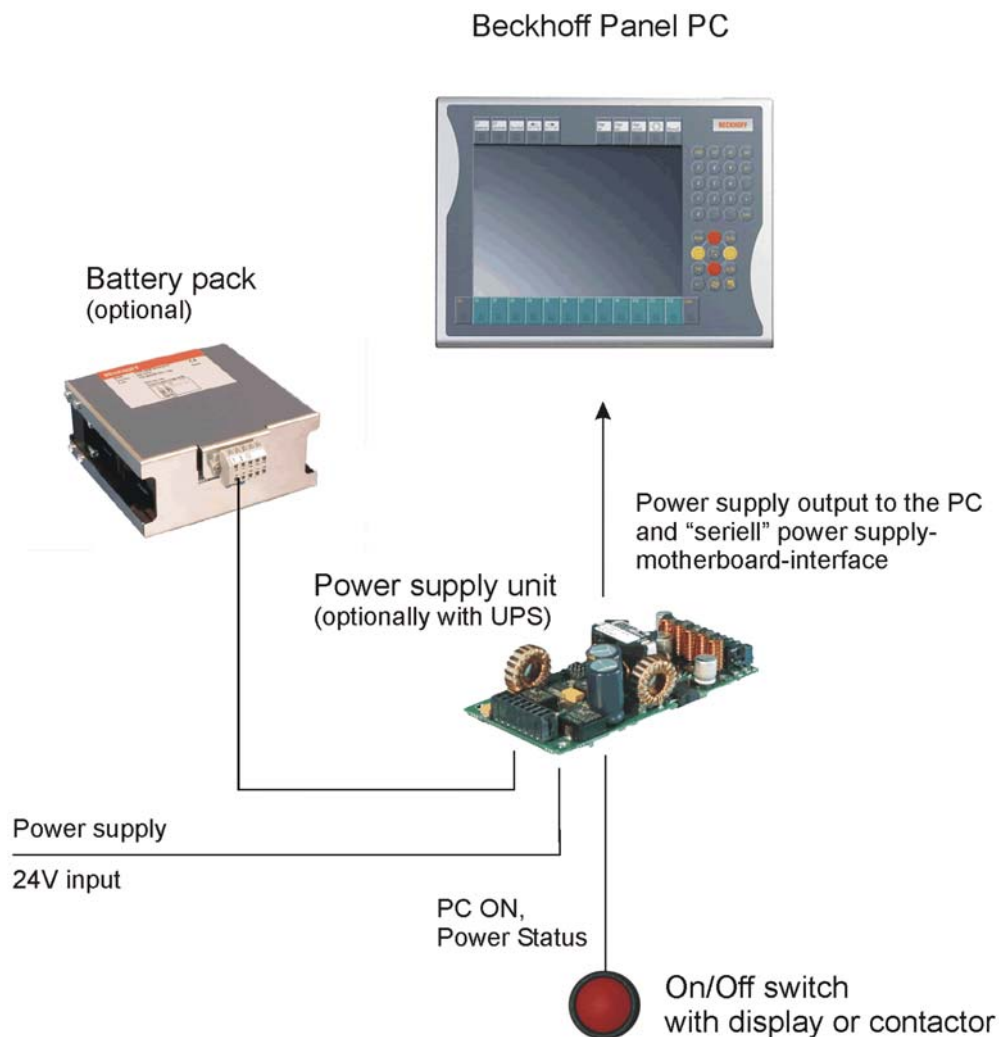

Innovative solution for shutting down Industrial PCs

Industrial PCs equipped with a UPS are in actual use frequently switched off by simply turning off the supply voltage. In this case the PC shuts down via the battery. However, over time this reduces the service life of the battery.

The new Beckhoff power supply technology approach addresses this problem and now offers the user the option of switching the PC off without the need for using the battery, thereby reducing the load on the battery.

In addition to the main switch this innovative solution uses an ON/OFF switch for the machine. Basically, the main switch remains switched on and provides the power supply for the PC during shutdown. Via the PC ON-input of the power supply the PC gets the command to shut down the operating system.

Once the PC has shut down, the PC power supply unit sets the Power Status-output (P-S) to 0, what indicates that the process is complete and that the main voltage can be switched off. This can be done manually via a signal lamp connection or via a contactor. With this solution the main switch generally only has to be switched off if the control cabinet has to be opened. The battery will only be used in the event of a power failure.

For a detailed functional description please refer to section [Connecting Power Supply](#).

4.4 Connecting Power Supply

The external wiring consists of the connection of the power supply, the battery pack (optional) and the connection of customized components for shutting down the PC.

4.4.1 Cable Cross Sections

For the connection of the power supply, wiring with a cable-cross-section of 1.0 mm^2 must be used.

With bigger distances between voltage source and PC, you take the voltage drop as a function of the cable-cross-section as well as voltage fluctuations of your distribution voltage into account, so that is secured that the voltage doesn't fall under 22 V at the power supply.

 Note	<p>Connecting with bigger distances between voltage source and PC</p> <p>To avoid voltage drop, the battery pack and the power supply each can be connected by using a second cable.</p>
--	---

 Attention	<p>Insert fuse</p> <p>The power supply must be protected with maximum 10 A.</p>
---	--

4.4.2 Check voltage rating and connect

Fitted with the 24 V_{DC} power supply unit:

1. Check that the external power supply is providing the correct voltage.
2. Insert the power supply cable that you have assembled into the Industrial PC's power supply socket. Then connect it to your external 24 V power supply.

 Attention	<p>Use same type of rechargeable battery</p> <p>If a 24 V UPS is installed, the same type of rechargeable battery must be used.</p>
---	--

4.4.3 Configuration for shutting down the PC

The connections for shutting down the Industrial PCs are established via the **PC_ON** input and the **Power Status** output.

4.4.4 PC_ON and Power Status functions

- If the **PC_ON** input is connected to 24 V via a switch, the PC shuts down according to the rules. The **PC_ON** signal is inverted, i.e. the PC shuts down if the 24 V connection is live.
- If the **PC_ON** input is *NOT* connected by the user, the PC can be booted in the familiar way by connecting the supply voltage and shut down via the battery by switching off the supply voltage.

 Attention	<p>Service life of the rechargeable battery</p> <p>This procedure significantly reduces the service life of the rechargeable battery and should therefore not be used.</p>
---	---

- Once the PC has shut down, the **Power Status** output is switched from 24 V to 0 V. Via this output a signal lamp can be connected or a contactor for de-energizing the whole system. The maximum load for the **Power Status** output is 0.5 A and a suitable fuse should be provided.

4.4.5 Wiring diagram

Wiring according to the wiring diagram (the circuit of PC_ON and Power-Status is symbolical):

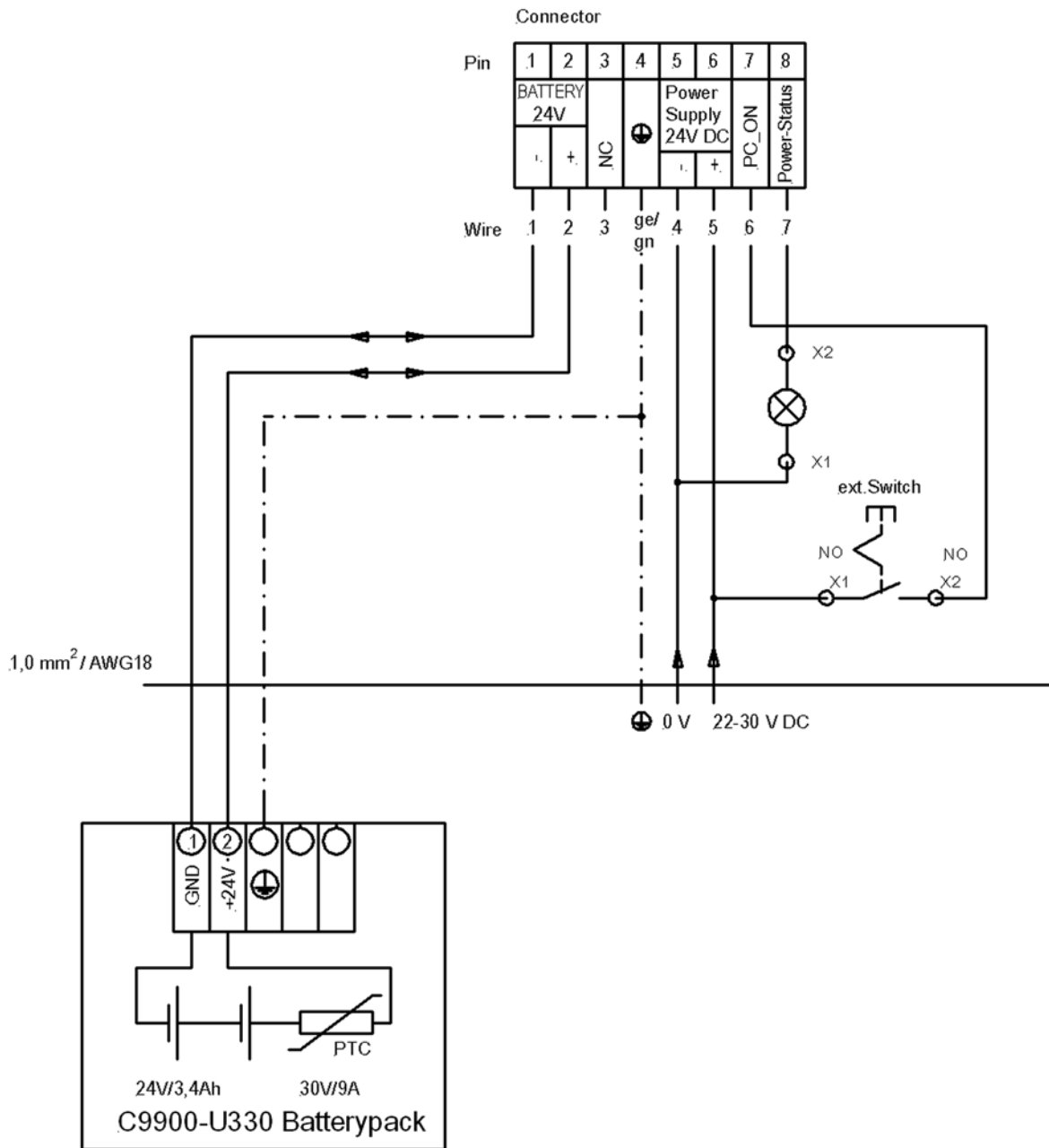

 Note	<p>Connection of the Battery Pack and UPS Output</p> <p>Connection of the Battery Pack and UPS Output only in combination with integrated UPS (order option).</p>
--	--

4.5 Connecting the Panel PC

 Attention	<p>The mains plug must be disconnected</p> <p>Please read the documentation for the external devices prior to connecting them!</p> <p>During thunderstorms, plug connector must neither be inserted nor removed!</p> <p>When disconnecting a plug connector, always handle it at the plug. Do not pull the cable!</p>
---	--

4.5.1 Connecting cables

The connections are located at the rear side of the Panel PC behind a cover and are documented in the chapter [Product Description](#).

When connecting cables to the Panel PC, please adhere to the following order:

- Disconnect the Panel PC from the power supply.
- Connect all cables at the Panel PC and at the devices to be connected.
- Ensure that all screw connections between connectors and sockets are tight!
- Reconnect all devices to the power supply.

4.5.2 Earthing measures

Earthing connections dissipate interference from external power supply cables, signal cables or cables to peripheral equipment. Establish a low-impedance connection from the earthing point on the Panel PC housing (see chapter [Ground connection](#)) to the central earthing point on the control cabinet wall, in which the computer is being installed.

 Note	<p>Malfunction possible with missing ground connection</p> <p>A proper ground connection of the device is absolutely necessary for the correct function of the touchscreen.</p>
--	--

5 Operating Instructions

5.1 Switching the Panel PC on and off

5.1.1 Switching on

The Panel PC does not have its own mains power switch. As soon as the power supply is switched on the Panel PC is activated.

5.1.2 Shutting down and switching off

Control software such as is typically used on Industrial PCs permits various users to be given different rights. A user who may not close software may also not switch the Panel PC off, since data can be lost from the storage medium by switching off while software is running.

 Warning	<p>First shut down, then switch off!</p> <p>If the Panel PC is switched off as the software is writing a file to the storage medium, the file will be destroyed. Control software typically writes something to the storage medium every few seconds, so that the probability of causing damage by switching off while the software is running is very high.</p>
---	---

 Warning	<p>Switch off power supply</p> <p>When you have shut down the Panel PC, you have to switch off power supply for at least 10 seconds before rebooting the system. After resetting power supply the Panel PC will start booting automatically.</p>
---	---

5.1.3 First switching on and driver installation

When you switch on the Industrial PC for the first time, the pre-installed operating system (optional) will be started. In this case, all the required drivers for any additional, optional hardware components ordered with the PC will already have been installed.

If the PC was ordered without operating system, you have to install the operating system and the driver software for any auxiliary hardware yourself. Please follow the instructions in the documentation for the operating system and the additional devices.

5.2 Operation

The operation of the Panel PC occurs via the Touch Screen.

 Warning	<p>Risk of damaging the Touch Screen</p> <p>The touch screen may only be actuated by finger tips or with the touch screen pen. The operator may wear gloves but there must be no hard particles such as metal shavings, glass splinters embedded in the glove.</p>
---	---

 Warning	<p>Properly installation of the system and the multi-touch device</p> <p>Capacitive Touch Screens use the functional principle of capacitive alternation of the electrical field. Strong electrical fields can influence the functionality of the multi-touch devices.</p> <p>To ensure the correct function of the Touch Screen take care of a standardized installation of all parts of the system and an EMC-environment conforming to standards.</p>
---	---

5.3 Servicing and maintenance

5.3.1 Cleaning

 DANGER	<p>Disconnect power supply</p> <p>Switch off the device and all connected devices, and disconnect the device from the power supply.</p>
--	--

The device can be cleaned with a soft, damp cleaning cloth. Do not use any aggressive cleaning materials, thinners, scouring material or hard objects that could cause scratches.

5.3.2 Maintenance

The Panel PC is maintenance-free.

5.3.3 Replacing the battery of the motherboard

A used battery has to be replaced. See also chapter [Access to the memory device and the battery](#).

 WARNING	<p>Danger of Explosion!</p> <p>Replace battery only with the identical type or an alternative type recommended by the manufacturer. Notice correct polarity!</p>
---	---

 WARNING	<p>Handling of Lithium Batteries</p> <p>Lithium Batteries should not be recharged, exposed to fire, opened and they should be protected against sunlight and moisture.</p>
---	---

The used battery must be disposed of in accordance with national electronics scrap regulations.

5.4 Emergency procedures

In case of fire, the Panel PC should be extinguished with powder or nitrogen.

5.5 Shutting down

5.5.1 Disposal

 Note	<p>Observe national electronics scrap regulations</p> <p>Observe the national electronics scrap regulations when disposing of the device.</p>
--	--

In order to dispose of the device, it must be removed and fully dismantled:

- Housing components (polycarbonate, polyamide (PA6.6)) are suitable for plastic recycling.
- Metal parts can be sent for metal recycling.
- Electronic parts such as disk drives and circuit boards must be disposed of in accordance with national electronics scrap regulations.

6 UPS Software Components (optional)

6.1 Installation on the PC

For operating the power supply unit as a UPS, the UPS driver software and the associated UPS driver must be installed on the Industrial PC.

On delivery of the Beckhoff Industrial PC with operating system the software is already installed. Should the software not be installed on your PC, the drivers can be installed from the driver CD provided.

To install the UPS driver software, execute file **Beckhoff_UPS_vx.xx.xx.exe** from the subdirectory of **UPS\...** from the CD provided on the Industrial PC (Driver-archive for the Industrial-PC, C9900-S700-xxxx). The program is self-extracting and will guide the user through the installation routine.

6.2 Help files

The driver software comes with a detailed help function.

The help files can be called up either directly from the configuration register by clicking the Help button, or under via *Start > Programs > Beckhoff > UPS software components*.

7 Troubleshooting

 Note	<p>Pixel errors</p> <p>Pixel errors in the TFT display are production-caused and represent no complaint-reason!</p>
--	--

 Note	<p>Anomalies of the Touchscreen</p> <p>Anomalies of the touchscreen sensor are production-caused and represent no complaint-reason!</p>
--	--

Fault	Cause	Measures
The Panel PC shows no function	No power supply to the Panel PC Cable not connected	Check power supply cable 1. Correctly connect cable 2. Call Beckhoff Service
Panel PC boots, software starts, but control does not operate correctly	Cause of the fault is either in the software or in parts of the plant outside the Panel PC	Call the manufacturer of the machine or the software
The Panel PC functions only partially or only part of the time, e.g. no or dark picture	Faulty backlight in the display Defective components in the Panel PC	Call Beckhoff Service Call Beckhoff Service
Malfunction of the touchscreen	Bad or missing ground connection of the device	Establish ground connection
	Bad or missing ground connection of the user	User must stand on the floor with ordinary shoes

8 Assembly dimensions

For the assembly dimensions of the Panel PC please visit our homepage. Here you will find the actual drawings using the link:

http://www.beckhoff.de/german/download/technical_drawings.htm





Warning

Notice mounting orientation

The assembly of the unit must take place with the orientation diagrammed here.

9 Technical Data

 Danger	<p>Risk of explosion!</p> <p>Do not use the Control Panel in areas of explosive hazard!</p>
--	--

 Note	<p>Pixel errors</p> <p>Pixel errors in the TFT display are production-caused and represent no complaint-reason!</p>
--	--

 Note	<p>Anomalies of the Touchscreen</p> <p>Anomalies of the touchscreen sensor are production-caused and represent no complaint-reason!</p>
--	--

Product name	CP32xx			
Dimensions (B x H x T)	See chapter Assembly dimensions			
Weight	CP3212: 7.5 kg	CP3219: 10.2 kg	CP3221: 10.7 kg	CP3224: 11.7 kg
	CP3215: 8.0 kg			
	CP3216: 8.6 kg			
	CP3218: 9.6 kg			
Supply voltage	24 V _{DC} (22 – 30 V _{DC})			
Power consumption	CP3212: approx. 58 W	CP3219: approx. 67 W	CP3221: approx. 77 W	CP3224: approx. 87 W
	CP3215: approx. 62 W			
	CP3216: approx. 64 W			
	CP3218: approx. 67 W			
UL-compliance (in progress)	<ul style="list-style-type: none"> Using a power supply class 2 or Fuse protection with 4 A, according to UL 60950.2 chapter 2.5, table 2C 			
Interfaces	1 x RJ-45 Ethernet 10/100/1000 Mbit			
Protection class	IP65			
Shock resistance (Sinusoidal vibration)	EN 60068-2-6:	10 to 58 Hz: 0.035 mm	58 to 500 Hz: 0.5 G (~ 5 m/ s ²)	
Shock resistance (Shock)	EN 60068-2-27:	5 G (~ 50 m/ s ²), duration: 30 ms		
EMC compatibility	Resistance to interference conforms to EN 61000-6-2			
EMC compatibility	Emission of interference conforms to EN 61000-6-4			
Permissible ambient temperature	0°C to +45°C (operation) -25°C to +65°C (transport/ storage)			
Permissible relative humidity	to 95%, no condensation			
Transport and storage	The same values for atmospheric humidity and shock resistance are to be observed during transport and storage as in operation. Suitable packaging of the Panel PC can improve the resistance to impact during transport.			
Certifications	CE			

10 Appendix

10.1 Beckhoff Support and Service

Beckhoff and their partners around the world offer comprehensive support and service, making available fast and competent assistance with all questions related to Beckhoff products and system solutions.

10.1.1 Beckhoff branches and partner companies

Please contact your Beckhoff branch office or partner company for [local support and service](#) on Beckhoff products!

The contact addresses for your country can be found in the list of Beckhoff branches and partner companies: www.beckhoff.com. You will also find further [documentation](#) for Beckhoff components there.

10.1.2 Beckhoff company headquarters

Beckhoff Automation GmbH & Co. KG
Huelshorstweg 20
33415 Verl
Germany

Phone: + 49 (0) 5246/963-0
Fax: + 49 (0) 5246/963-198
E-mail: info@beckhoff.de
Web: <http://www.beckhoff.de/>

Beckhoff Support

Support offers you comprehensive technical assistance, helping you not only with the application of individual Beckhoff products, but also with other, wide-ranging services:

- world-wide support
- design, programming and commissioning of complex automation systems
- and extensive training program for Beckhoff system components

Hotline: + 49 (0) 5246/963-157
Fax: + 49 (0) 5246/963-9157
E-mail: support@beckhoff.com

Beckhoff Service

The Beckhoff Service Center supports you in all matters of after-sales service:

- on-site service
- repair service
- spare parts service
- hotline service

Hotline: + 49 (0) 5246/963-460
Fax: + 49 (0) 5246/963-479
E-mail: service@beckhoff.com

If servicing is required, please quote the **project number** of your product.

10.2 Approvals for USA and Canada

10.3 FCC Approvals for the United States of America

FCC: Federal Communications Commission Radio Frequency Interference Statement

This equipment has been tested and found to comply with the limits for a Class A digital device, pursuant to Part 15 of the FCC Rules. These limits are designed to provide reasonable protection against harmful interference when the equipment is operated in a commercial environment. This equipment generates, uses, and can radiate radio frequency energy and, if not installed and used in accordance with the instruction manual, may cause harmful interference to radio communications. Operation of this equipment in a residential area is likely to cause harmful interference in which case the user will be required to correct the interference at his own expense.

**Note****Technical modifications**

Technological changes to the device may cause the loss of the FCC approval.

10.4 FCC Approval for Canada

FCC: Canadian Notice

This equipment does not exceed the Class A limits for radiated emissions as described in the Radio Interference Regulations of the Canadian Department of Communications.