



Installation and Operating instructions for
**Control Cabinet PC
C6240 from -0060**

Version: 3.0
Date: 2020-04-24

BECKHOFF

Table of contents

1. General instructions	3
Notes on the Documentation	3
Liability Conditions	3
Trademarks	3
Patent Pending	3
Copyright	3
State at Delivery	3
Delivery conditions	3
Description of safety symbols	4
Basic safety measures	4
Operator's obligation to exercise diligence	5
Operator requirements	5
2. Product Description	6
Appropriate Use	6
Structure	6
Interfaces from C6240-0060	8
PS/2 connections	8
USB interfaces	8
Network connection	8
DVI-D (Digital Visual Interface)	8
Serial interface	8
DisplayPort	8
Sound-On-Board	8
Additional plug-in cards (optional)	8
3. Installation Instructions	9
Transport and Unpacking	9
Transport	9
Unpacking	9
Installation of the PC in the control cabinet	10
Earthing measures	10
Power Supply Connection	11
Current carrying capacity of the 24 V power supply unit	11
Fitting the Power Supply Cable	12
Pin assignment and cable requirements	13
Connecting Power Supply	14
Wiring diagram	15
Connecting devices	16
Connecting cables	16
Check voltage rating and connect.	16
4. Operating Instructions	17
Switching the Industrial PC on and off	17
First switching on and driver installation	17
Maintenance	18
Cleaning the Industrial PC	18
Replacing the battery on the motherboard	18
Servicing	18
Shutting down	18
Disposal	18
5. Troubleshooting	19
Fault correction	19
Service and Support	20
Beckhoff's branch offices and representatives	20
Beckhoff headquarters	20
Beckhoff Support	20
Beckhoff Service	20
6. Assembly dimensions	21

7. Appendix	24
Technical data	24
Approvals	24
FCC: Federal Communications Commission	24
Radio Frequency Interference Statement	24
FCC: Canadian Notice	24

General instructions

Notes on the Documentation

This description is only intended for the use of trained specialists in control and automation engineering who are familiar with the applicable national standards. It is essential that the following notes and explanations are followed when installing and commissioning these components.

The responsible staff must ensure that the application or use of the products described satisfy all the requirements for safety, including all the relevant laws, regulations, guidelines and standards.

Liability Conditions

The documentation has been prepared with care. The products described are, however, constantly under development. For that reason the documentation is not in every case checked for consistency with performance data, standards or other characteristics. In the event that it contains technical or editorial errors, we retain the right to make alterations at any time and without warning. No claims for the modification of products that have already been supplied may be made on the basis of the data, diagrams and descriptions in this documentation.

All pictures shown in the documentation are exemplary. Illustrated configurations can differ from standard.

Trademarks

Beckhoff®, TwinCAT®, EtherCAT®, Safety over EtherCAT®, TwinSAFE® and XFC® are registered trademarks of and licensed by Beckhoff Automation GmbH.

Other designations used in this publication may be trademarks whose use by third parties for their own purposes could violate the rights of the owners.

Patent Pending

The EtherCAT Technology is covered, including but not limited to the following patent applications and patents:

EP1590927, EP1789857, DE102004044764, DE102007017835

with corresponding applications or registrations in various other countries.

The TwinCAT Technology is covered, including but not limited to the following patent applications and patents:

EP0851348, US6167425 with corresponding applications or registrations in various other countries.

Copyright

© Beckhoff Automation GmbH & Co.KG.

The reproduction, distribution and utilization of this document as well as the communication of its contents to others without express authorization are prohibited. Offenders will be held liable for the payment of damages. All rights reserved in the event of the grant of a patent, utility model or design.

State at Delivery

All the components are supplied in particular hardware and software configurations appropriate for the application. Modifications to hardware or software configurations other than those described in the documentation are not permitted, and nullify the liability of Beckhoff Automation GmbH & Co.KG.

Delivery conditions

In addition, the general delivery conditions of the company Beckhoff Automation GmbH & Co.KG apply.

Description of safety symbols

The following safety symbols are used in this operating manual. They are intended to alert the reader to the associated safety instructions.



Danger

This symbol is intended to highlight risks for the life or health of personnel.



Warning

This symbol is intended to highlight risks for equipment, materials or the environment.



Note

This symbol indicates information that contributes to better understanding.

Basic safety measures

Only switch the PC off after closing the software

Before the Industrial PC is switched off, software that is running must be properly closed.

Otherwise it is possible that data on the hard disk is lost. Please read the section on [Switching the Industrial PC on and off](#).



Warning

Switch off all parts of the equipment, then uncouple the fieldbus!

Before opening the housing of the PC, and whenever the PC is being used for purposes other than plant control, such as during functional tests following repair, all parts of the equipment must first be switched off, after which the Industrial PC can be uncoupled from the plant.

Pulling out the fieldbus connection plug uncouples the PC (optional).

Items of equipment that have been switched off must be secured against being switched on again.

The Industrial PC's power supply unit must be supplied with 100-240 V_{AC} or 24 V_{DC} (optional).



Danger

Do not open the power supply unit while voltage is applied!

The supply voltage must be switched off before the power supply unit housing is opened.

Do not exchange any parts when under power!

When components are being fitted or removed, the supply voltage must be switched off.

Fitting work on the Industrial PC can result in damage:

- If metal objects such as screws or tools fall onto operating circuit boards.
- If connecting cables internal to the PC are removed or inserted during operation.
- If plug-in cards are removed or inserted when the PC is switched on.

Operator's obligation to exercise diligence

The operator must ensure that

- the Industrial PC is only used for its intended use (see also [Product Description](#)).
- the Industrial PC is in a sound condition and in working order during operation.
- the operation manual is in good condition and complete, and always available for reference at the location of the Industrial PC.
- the Industrial PC is operated, maintained and repaired only by sufficiently qualified and authorised personnel.
- the personnel is instructed regularly about relevant occupational safety and environmental protection aspects, and is familiar with the operating manual and in particular the safety notes contained herein.
- none of the safety and warning notes attached to the Industrial PC are removed, and that all notes remain legible.

National regulations depending on the machine type

Depending on the type of machine and plant in which the Industrial PC is being used, there will be national regulations for the control of such machines and plant that the operator must observe. These regulations cover, amongst other things, the intervals between inspections of the controller.

The operator must initiate such inspections in good time.



Warning

Only trained persons may open the Industrial PC housing!

The operator is responsible for ensuring that only trained electrical staff opens the housing of the Industrial PC.

Procedure in the event of a fault

In the event of a fault in the Industrial PC, appropriate measures can be determined with the aid of the list in the [Fault correction](#) section.

Operator requirements

Read the operating instructions

Every user of the Industrial PC must have read these operating instructions.

Software knowledge

Every user must be familiar with any of the functions of the software installed on the PC that he can reach.

Product Description

Appropriate Use

The C6240 Industrial PCs is designed for mounting in control cabinets for machine and plant engineering applications.

Structure

Front view of Industrial PC C6240



Opening the housing

To open the PC housing, initially rotate the two fast closing screws (see photograph above) by 90 degrees in either direction using a screwdriver. The inner chassis can now be pulled out on telescopic guide supports (see photograph below).

Removable inner chassis

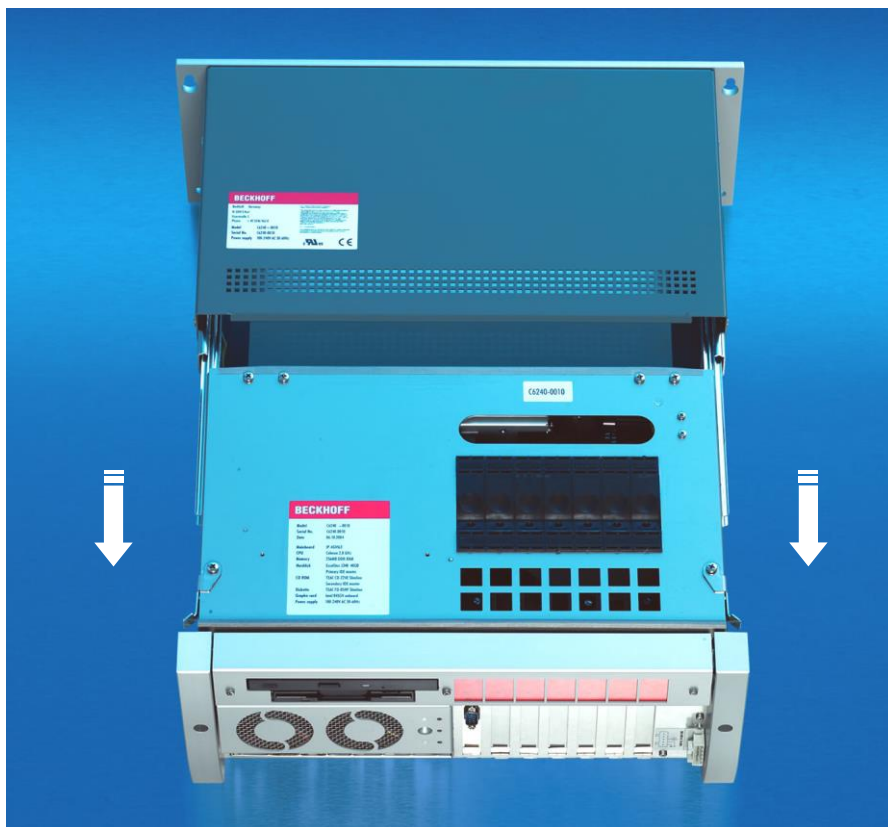

After unlocking, the upper housing cover can now be tilted upwards (see following photograph), thus providing access to the floppy disk drive, hard disk, processor, memory and plug-in cards.

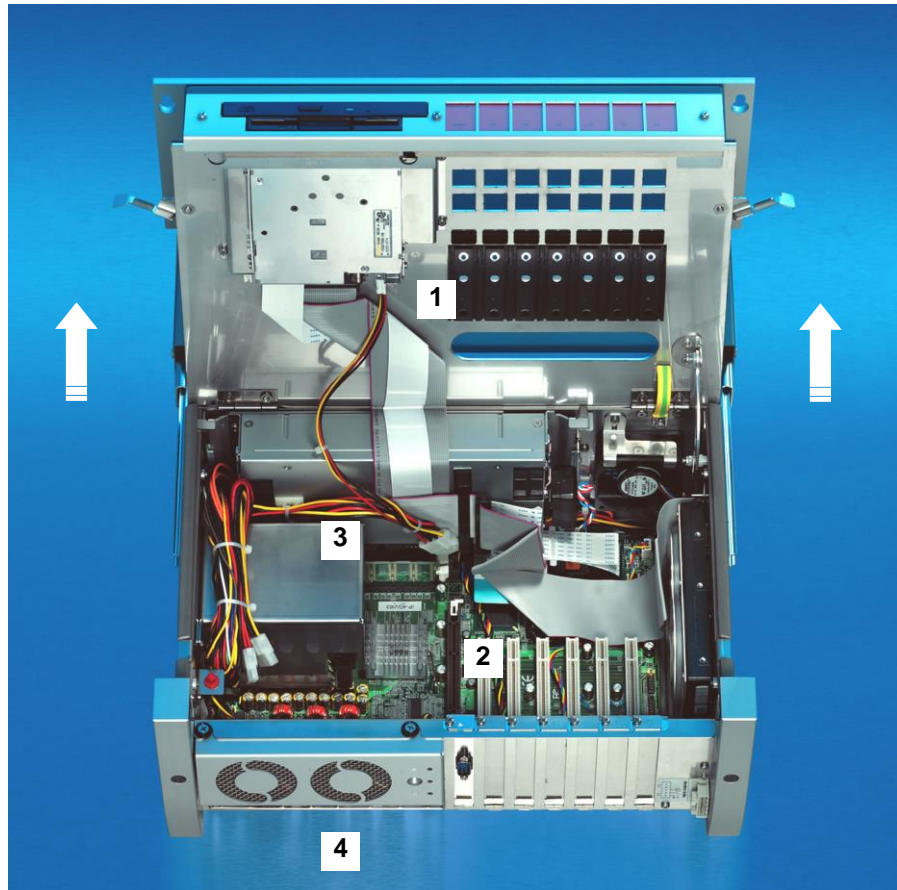
View of the open PC

Under the housing cover (1) is a 7 slot computer core with standard ATX motherboard (2) and power supply unit (3). The connections are located at the front of the housing (4).

Interfaces from C6240-0060

ATX motherboard
interfaces



PS/2 connections

PS/2

The upper PS/2 connector (**X104**) allows a PS/2 mouse to be used, while a PC keyboard can be connected to the lower PS/2 connector (**X103**).

USB interfaces

USB1 – USB4

The four USB interfaces (**X108 – X111**) are used to connect peripheral devices with USB connections:

- Devices with Intel® 4th generation processors (C6240-0060) are equipped with 2 USB2.0 (**X110**, **X111**) and 2 USB3.0 (**X108**, **X109**) interfaces.
- Devices from Intel® 6th and 7th generation processors (C6240-0070) are equipped with 4 USB3.0 interfaces.

Network connection

LAN1, LAN2

The RJ-45 connectors (**X112**, **X113**) allow the PC to be connected to a 10/100/1000BASE-T Local Area Network (LAN).

DVI-D (Digital Visual Interface)

DVI out

The DVI connectors (**X114**, **X115**) are used for transferring the video signal. DVI-D standard is supported.

Serial interface

RS 232
COM1

The basic version of the Industrial PC has one serial interface COM1 (**X116**), using the type RS 232. The interface is brought to a 9 pin SUB-D plug connector.

DisplayPort

DisplayPort

The DisplayPort (**X117**) is used for transferring the video signal.

Sound-On-Board

Sound

The Industrial PC has an on-board-interface with the following connectors: Line In (**X122**), Line Out (**X121**) and Microphone jack (**X120**).

Additional plug-in cards (optional)

Type plate

There is a type plate on the top of the Industrial PC which provides information about the hardware configuration of the Industrial PC at the time it was supplied.

Installation Instructions

Please also refer to chapter [General instructions](#).

Transport and Unpacking

The specified storage conditions must be observed (see chapter [Technical data](#)).

Transport

Despite the robust design of the unit, the components are sensitive to strong vibrations and impacts. During transport, your Industrial PC should therefore be protected from excessive mechanical stress. Therefore, please use the original packaging.



Warning

Danger of damage to the unit!

If the device is transported in cold weather or is exposed to extreme variations in temperature, make sure that moisture (condensation) does not form on or inside the device.

Prior to operation, the unit must be allowed to slowly adjust to room temperature. Should condensation occur, a delay time of approximately 12 hours must be allowed before the unit is switched on.

Unpacking

Proceed as follows to unpack the unit:

1. Remove packaging.
2. Do not discard the original packaging. Keep it for future relocation.
3. Check the delivery for completeness by comparing it with your order.
4. Please keep the associated paperwork. It contains important information for handling the unit.
5. Check the contents for visible shipping damage.
6. If you notice any shipping damage or inconsistencies between the contents and your order, you should notify Beckhoff Service.

Installation of the PC in the control cabinet

The C6240 Industrial PC is designed for mounting in control cabinets for machine and plant engineering applications.

The ambient conditions specified for operation must be observed (see chapter [Technical data](#)).

Preparation of the control cabinet

Four holes for the fixing bolts have to be provided in the control cabinet according to the dimensions of the PC (see chapter [Assembly dimensions](#)).



Note

When the unit is installed in an enclosure, adequate space for ventilation and for opening the PC must be provided.

The clearance above and below the housing must be at least 50 mm in order to ensure adequate ventilation of the PC.



Warning

Extreme environmental conditions should be avoided as far as possible. Protect the PC from dust, moisture and heat.

The ventilation slots of the PC must not be covered.

Earthing measures

Earthing measures

Earthing connections dissipate interference from external power supply cables, signal cables or cables to peripheral equipment.



Establish a low-impedance connection from the earthing point on the PC housing to the central earthing point on the control cabinet wall, in which the computer is being installed. The earthing connection is located at the bottom side of the housing (see photograph on the left).

Power Supply Connection

The 5-pin CAGE CLAMP plug connector and mounting flange illustrated is located on the PC housing in order to connect the power supply.

Socket at the PC housing

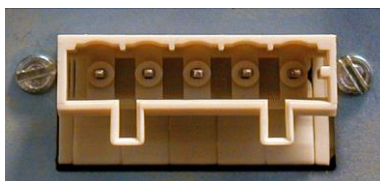

Technical data	Connecting socket
Number of contacts	5
Contact spacing	5 mm
Minimum conductor cross-section	1.5 mm ²
Minimum conductor cross-section (AWG)	16
Rated voltage (EN)	250 V
Rated voltage (CSA)	300 V
Current EN [A]	12 A
Current CSA [A]	15 A
Length of stripped conductor	8 to 9 mm

Supplied mains power unit

The Industrial PCs is either fitted with a 100-240 V, 50-60 Hz power supply unit (standard) or with a 24 V_{DC} power supply unit (with the option of an uninterruptible power supply, UPS).

Current carrying capacity of the 100-240 V power supply unit

Output voltages from the 100-240 V power supply unit	Current loading maximum
+3.3 V	16 A
+5 V stand by	2 A
+5 V	25 A
-5 V	0.3 A
+12 V	13 A
-12 V	0.8 A

Current carrying capacity of the 24 V power supply unit

Current carrying capacity of the 24 V power supply unit

Output voltages from the 24 V power supply unit	Current loading maximum
+5 V	25 A
-5 V	1 A
+12 V	10 A
-12 V	1.5 A

Fitting the Power Supply Cable

Coding pieces



Differently coded plug connectors

The connectors are coded differently at the factory, using snap-on coding pieces, according to the power supply unit that has been fitted.

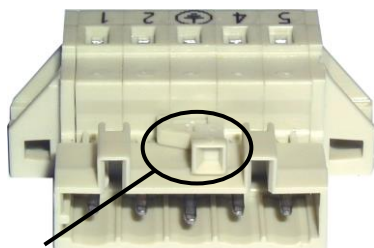

Coding for the 100-240 V_{AC}, 50-60 Hz power supply unit

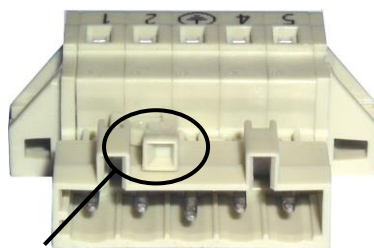

Coding for the 24 V_{DC} power supply unit

A 5-pin female plug connector with CAGE CLAMP connection and insertion catches is supplied along with a snap-on strain relief housing in order to assemble the PC power supply cable.

Materials for assembly of the connector



Female plug connector



Strain relief housing

Female plug connector is correspondingly coded

This female plug connector is also coded at the factory, according to the type of power supply fitted, so that the plug, when assembled, will fit the Industrial PC's connecting socket.

Technical data	Female plug connector
Number of contacts	5
Contact spacing	5 mm
Minimum conductor cross-section	1.5 mm ²
Minimum conductor cross-section (AWG)	16
Rated voltage (EN)	250 V
Rated voltage (CSA)	300 V
Current (EN)	16 A
Current (CSA)	15 A
Length of stripped conductor	8 to 9 mm

Pin assignment and cable requirements

Pin assignment

There is an adhesive label with the pin assignments on the top of the female plug connector. **The minimum permitted conductive cross-section is 1.5 mm², fused for 10 A (AWG 16).**

Industrial PCs with 100-240 V_{AC}, 50-60 Hz power supply unit

Pin assignment for the 100-240 V, 50-60 Hz power supply unit

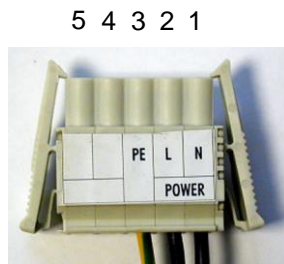

Pin	Function
1	N
2	L
3	⊕
4	not used
5	not used

Industrial PCs with 24 V_{DC} power supply unit

Pin assignment for the 24 V_{DC} power supply unit

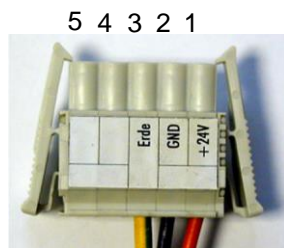

Pin	Function
1	+
2	-
3	⊕
4	not used
5	not used

Pin assignment for connecting the power switch



1 2 3

Pin	Funktion
1	Power-Status
2	PC_ON
3	24 V _{DC} Versorgungsspannung + Pol

Fitting the connector to the cable

The plug is fitted to the cable as follows:

1. Strip insulation from the cable ends. Follow the technical data for the female plug connector in the above table!
2. Push the conductors into their mountings, simply by pushing them in as indicated on the pin assignment label.
3. Push the lower part (part **A**) of the strain relief housing onto the top of the female plug connector until it snaps into place.
4. Relieve the strain on the supply cable by fixing it in place with the cable clamp (part **C**) and fixing screws (part **D**).

Applying the strain relief



5. Fix the upper part (part **B**) of the strain relief housing by snapping it onto the lower part.

Connecting Power Supply

The external wiring consists of the connection of the power supply, the battery pack (optional) and the connection of customized components for shutting down the PC.

Cable Cross Sections

Cable-cross-section for connection of power supply

For the connection of the power supply, wiring with a cable-cross-section of 1.5 mm² must be used.

With bigger distances between voltage source and PC, you take the voltage drop as a function of the cable-cross-section as well as voltage fluctuations of your distribution voltage into account, so that is secured that the voltage doesn't fall under 22 V at the power supply.

The power supply must be protected with maximum 16 A.



Warning

Configuration for shutting down the PC

The connections for shutting down the Industrial PCs are established via the **PC_ON** input and the **Power Status** output.

PC_ON and Power Status functions

PC_ON und power status

- If the **PC_ON** input is connected to 24 V via a switch, the PC shuts down according to the rules. The **PC_ON** signal is inverted, i.e. the PC shuts down if the 24 V connection is live.
- If the **PC_ON** input is *NOT* connected by the user, the PC can be booted in the familiar way by connecting the supply voltage and shut down via the battery by switching off the supply voltage.



Warning

This procedure significantly reduces the service life of the rechargeable battery and should therefore not be used.

- Once the PC has shut down, the **Power Status** output is switched from 24 V to 0 V. Via this output a signal lamp can be connected or a contactor for de-energizing the whole system. The maximum load for the **Power Status** output is 0.5 A and a suitable fuse should be provided.

UPS Output

UPS output

In order to maintain a screen display for the PC in the event of a power failure, the power supply unit is equipped with a **UPS output** for connecting a Control Panel. The maximum load for the output is 1.4 A (max. 2.5 A from 2016 and later).

UPS output function

UPS output function

- The 24 V DC connection at the UPS output is live even after a power failure. The maximum load is 1.4 A (max. 2.5 A from 2016 and later).
- Once the PC has been de-energized via the UPS software, the **UPS output** is switched to 0 V. Any connected panel is thus switched off, and total discharge of the rechargeable battery is prevented.

Wiring diagram

Wiring according to the wiring diagram (the circuit of PC_ON and Power-Status is symbolical):

Wiring diagram external switch and power supply

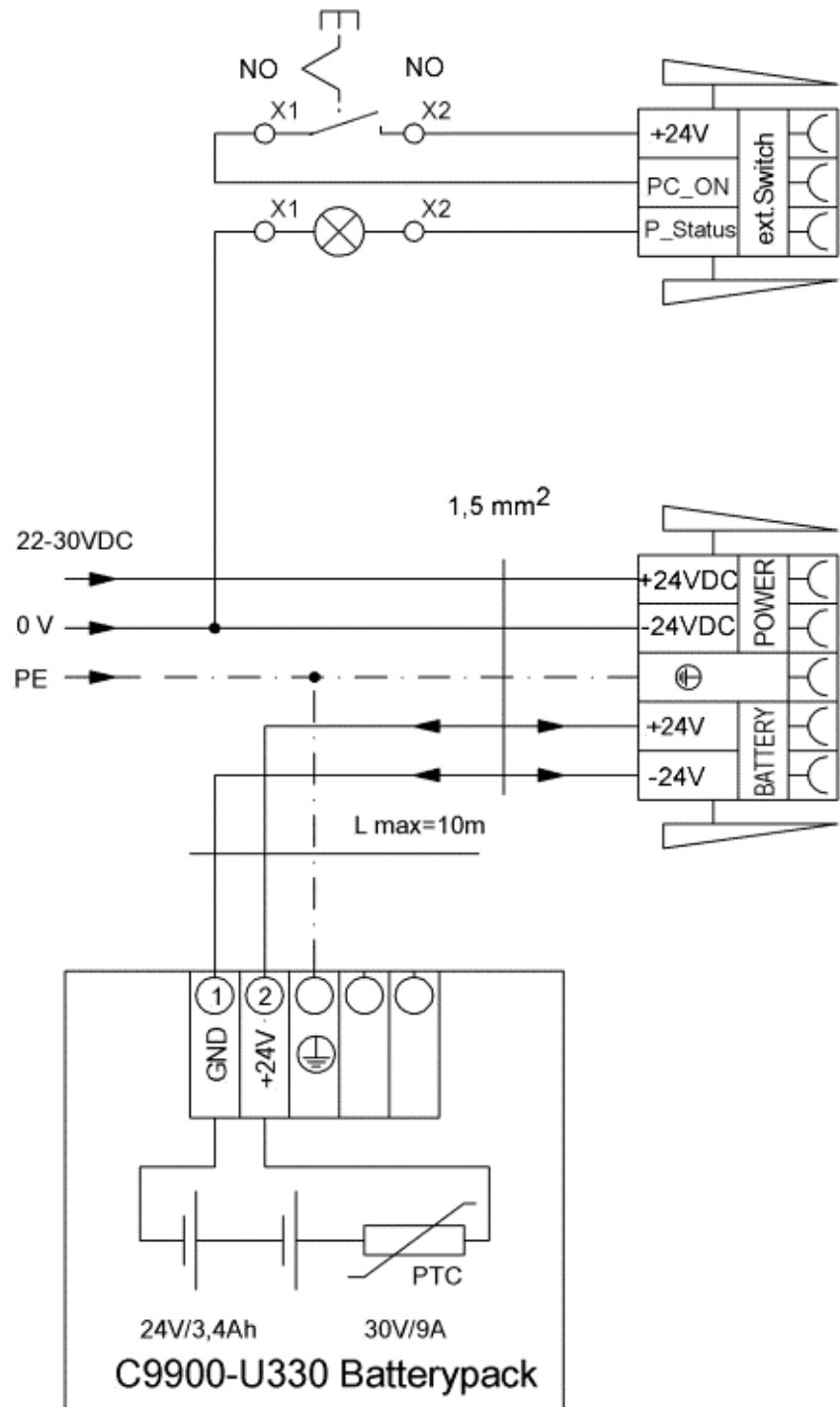

Connection of the Battery Pack and UPS Output only in combination with integrated UPS (order option).

Connecting devices



Warning

The power supply plug must be withdrawn!

Please read the documentation for the external devices prior to connecting them.

During thunderstorms, plug connector must neither be inserted nor removed.

When disconnecting a plug connector, always handle it at the plug. Do not pull the cable!

Connecting cables

The connections are located at the top of the Industrial PC and are documented in the product description chapter.

When connecting the cables to the Industrial PC, proceed according to the following sequence:

- Switch off all the devices that are to be connected.
- Disconnect all the devices that are to be connected from the power supply.
- Connect all the cables between the Industrial PC and to the devices that are to be connected.
- Connect all data transfer cables (if present) to the appropriate plug-in receptacles of the data/telecommunication networks.
- Reconnect all devices to the power supply.

Check voltage rating and connect.

With compact 100-240 V_{AC} 50/60 Hz power supply:

1. Check that the mains voltage is correct.
2. Insert the power supply cable that you have assembled (see the section on [Fitting the Power Supply Cable](#)) into the Industrial PC's power supply socket. Then connect it to a power socket with a grounded earth connection.

When fitted with the (optional) 24 V_{DC} power supply unit:

1. Check that the external power supply is providing the correct voltage.
2. Insert the power supply cable that you have assembled (see the section on [Fitting the Power Supply Cable](#)) into the Industrial PC's power supply socket. Then connect it to your external 24 V power supply.



Warning

If a 24 V UPS is installed, the correct type of rechargeable battery must be used.

Operating Instructions

Please also refer to chapter [General instructions](#).

Switching the Industrial PC on and off

Switch on

The Industrial PC does not have its own mains switch. The Industrial PC will start when the equipment is switched on, or when it is connected to the power supply.

Shutting down and switching off

When the plant is switched off, or when it is disconnected from its power supply, the Industrial PC will be switched off.

Control software such as is typically used on Industrial PCs permits various users to be given different rights. A user who may not close software may also not switch the Industrial PC off, since data can be lost from the hard disk by switching off while software is running.



Warning

First shut down, then switch off the PC!

If the Industrial PC is switched off as the software is writing a file to the hard disk, the file will be destroyed. Control software typically writes something to the hard disk every few seconds, so that the probability of causing damage by switching off while the software is running is very high.



Warning

When you have shut down the Industrial PC, you have to switch off power supply for at least 10 seconds before rebooting the system. After resetting power supply the PC will start booting automatically.

Reset key

A Reset button for rebooting the system is provided on the front cover.



LEDs

Three LEDs are located next to the Reset button. The red LED signals hard disk activity. The green LED signals the presence of the voltage supply. The yellow LED is inoperable.

First switching on and driver installation

When you switch on the Industrial PC for the first time, the pre-installed operating system (optional) will be started. In this case, all the required drivers for any additional, optional hardware components ordered with the PC will already have been installed.

If the PC was ordered without operating system, you have to install the operating system and the driver software for any auxiliary hardware yourself. Please follow the instructions in the documentation for the operating system and the additional devices.

Maintenance

Please also refer to chapter [General instructions](#).

Cleaning the Industrial PC



Danger

Switch off the Industrial PC and all connected devices, and disconnect the Industrial PC from the power supply.

The Industrial PC can be cleaned with a soft, damp cloth. Do not use any aggressive cleaning materials, thinners, scouring material or hard objects that could cause scratches.

Replacing the battery on the motherboard

A used battery on the motherboard has to be replaced.



Danger

Danger of Explosion!

Replace battery only with the identical type or an alternative type recommended by the manufacturer. Notice correct polarity!



Danger

Handling of Lithium Batteries

Lithium Batteries should not be recharged, exposed to fire, opened and they should be protected against sunlight and moisture.

The used battery must be disposed of in accordance with national electronics scrap regulations.

Servicing

The Industrial PC requires no maintenance.

Shutting down

Disposal

The device must be fully dismantled in order to dispose of it. The housing can be sent for metal recycling.

Electronic parts such as disk drives and circuit boards must be disposed of in accordance with national electronics scrap regulations.

Dismantling the Industrial PC

Observe national electronics scrap regulations

Troubleshooting

Please also refer to chapter [General instructions](#).

Fault correction

Fault	Cause	Procedure
Nothing happens after the Industrial PC has been switched on	No power supply to the Industrial PC.	Check power supply cable.
	Other cause.	Call Beckhoff Service.
The Industrial PC does not boot fully	Floppy disk or CD in the drive.	Remove floppy disk or CD and press any key.
	Setup settings are incorrect.	Check the setup settings.
	Other cause.	Call Beckhoff Service.
Computer boots, software starts, but control does not operate correctly	Cause of the fault is either in the software or in parts of the plant outside the Industrial PC.	Call the manufacturer of the machine or the software.
Floppy disk or CD access error	Faulty disk or CD.	Check disk or CD in another drive.
	Faulty disk drive.	Call Beckhoff Service.
The Industrial PC functions only partially or only part of the time, e.g. no or dark picture, but disk drive responds when switching on	Defective components in the Industrial PC.	Call Beckhoff Service.

Service and Support

Beckhoff and their partners around the world offer comprehensive service and support, making available fast and competent assistance with all questions related to Beckhoff products and system solutions.

Beckhoff's branch offices and representatives

Please contact your Beckhoff branch office or representative for [local support and service](#) on Beckhoff products!

The addresses of Beckhoff's branch offices and representatives round the world can be found on her internet pages:

<http://www.beckhoff.com>

You will also find further [documentation](#) for Beckhoff components there.

Beckhoff headquarters

Beckhoff Automation GmbH & Co. KG
Huelshorstweg 20
D-33415 Verl
Germany

Phone: +49(0)5246/963-0
Fax: +49(0)5246/963-198
e-mail: info@beckhoff.com

Beckhoff Support

Support offers you comprehensive technical assistance, helping you not only with the application of individual Beckhoff products, but also with other, wide-ranging services:

- world-wide support
- design, programming and commissioning of complex automation systems
- and extensive training program for Beckhoff system components

Hotline: +49(0)5246/963-157
Fax: +49(0)5246/963-9157
e-mail: support@beckhoff.com

Beckhoff Service

The Beckhoff Service Center supports you in all matters of after-sales service:

- on-site service
- repair service
- spare parts service
- hotline service

Hotline: +49(0)5246/963-460
Fax: +49(0)5246/963-479
e-mail: service@beckhoff.com

Quote the project number

If servicing is required, please quote the **project number** of your Industrial PC.

Assembly dimensions

The following pages show diagrams of the Industrial PC, with dimensions in mm.



Warning

The assembly of the unit must take place with the orientation diagrammed here.

Horizontal Installation

Front View

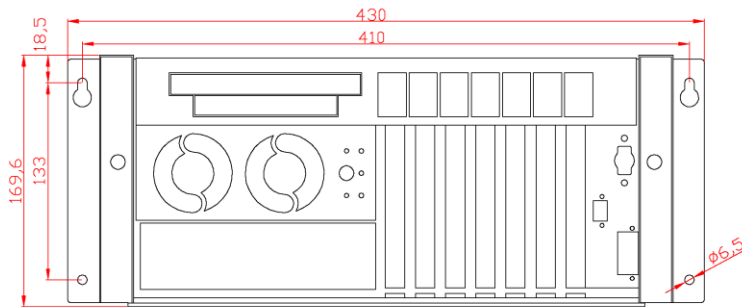

Side View

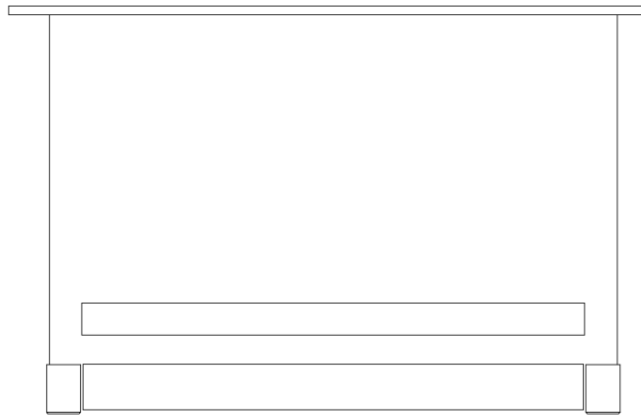
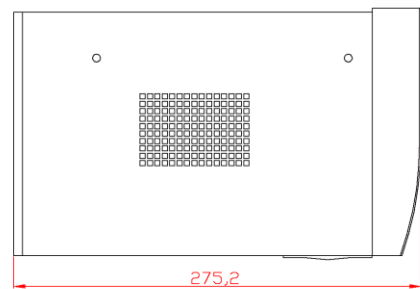

Top View



Warning

The assembly of the unit must take place with the orientation diagrammed here.

Horizontal Installation

With C9900 – M630

Front View

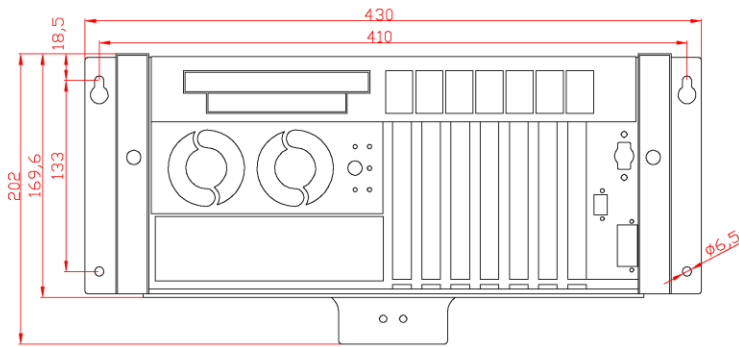

Side View

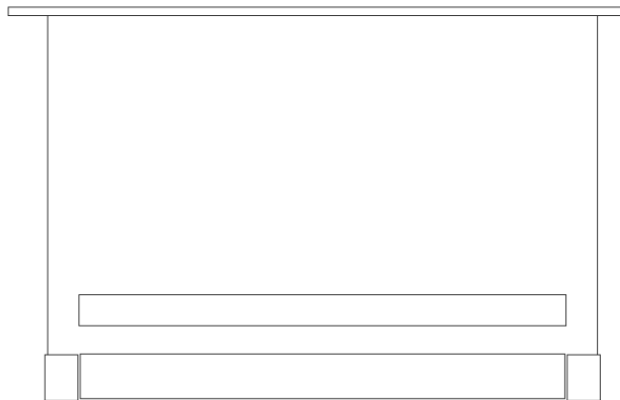
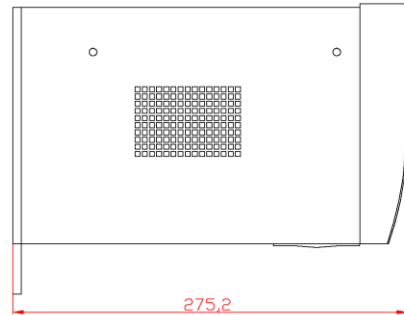

Top View



Warning

The assembly of the unit must take place with the orientation diagrammed here.

Vertical Installation

Side View

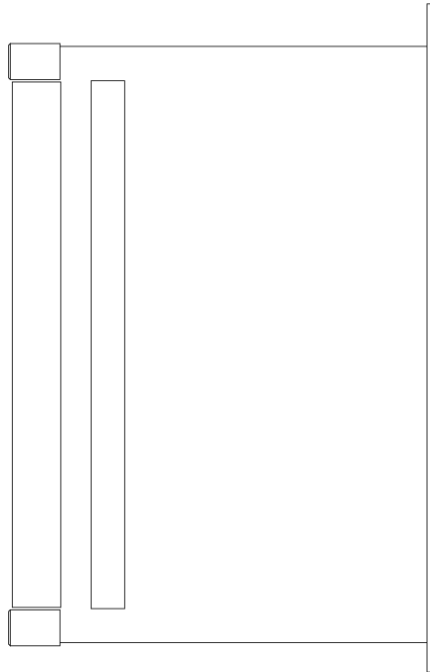

Front View

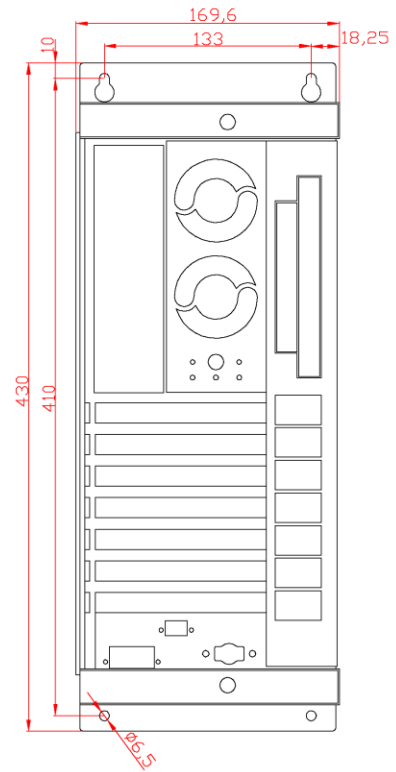

Top View

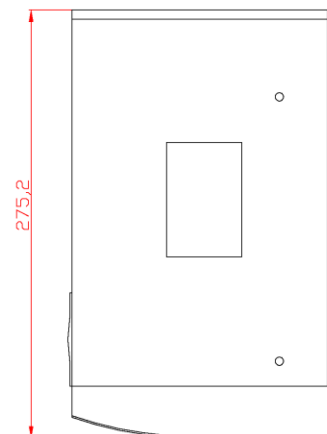

Appendix

Technical data

<i>Industrial PC C6240</i>	Dimensions (W x H x D):	430 x 170 x 274 mm
	Weight:	12.3 kg (basic configuration)
<i>Do not use the PC in areas of explosive hazard</i>	The Industrial PC may not be used in areas of explosive hazard.	
	The following conditions must be observed during operation:	
<i>Environmental conditions</i>	Ambient temperature:	0 to 55°C
	Atmospheric humidity:	Maximum 95%, non-condensing
<i>Shock resistance</i>	Sinusoidal vibration:	
	(EN 60068-2-6)	10 to 58 Hz: 0.035 mm 58 to 500 Hz: 0.5 G (~ 5 m/ s ²)
	During reading of CD-ROM:	10 to 58 Hz: 0.019 mm 58 to 500 Hz: 0.25 G (~ 2.5 m/ s ²)
	Impact:	
	(EN 60068-2-27)	5 G (~ 50 m/ s ²), duration: 30 ms
	During reading of CD-ROM:	5 G (~ 50 m/ s ²), duration: 11 ms
<i>Protection class</i>	Protection class:	IP20
<i>Power supply 100-240 V_{AC} power pack</i>	Supply voltage:	100-240 V 50-60 Hz
	Power consumption:	100 W for the basic version
<i>Power supply 24 V_{DC} power pack (optional)</i>	Supply voltage:	22 - 30 V _{DC}
	Power consumption:	100 W for the basic version
<i>Electromagnetic Compatibility (EMC)</i>	Interference resistance:	according to EN 61000-6-2
	Emitted resistance:	according to EN 61000-6-4
<i>Transport and storage</i>	The same values for atmospheric humidity and shock resistance are to be observed during transport and storage as in operation. The shock resistance during transport can be improved by means of suitably packing the Industrial PC. The ambient temperature during storage and transport must be between -20°C and +65°C.	

Approvals

FCC: Federal Communications Commission

Radio Frequency Interference Statement

FCC Approval for USA

This equipment has been tested and found to comply with the limits for a Class A digital device, pursuant to Part 15 of the FCC Rules. These limits are designed to provide reasonable protection against harmful interference when the equipment is operated in a commercial environment. This equipment generates, uses, and can radiate radio frequency energy and, if not installed and used in accordance with the instruction manual, may cause harmful interference to radio communications. Operation of this equipment in a residential area is likely to cause harmful interference in which case the user will be required to correct the interference at his own expense.

FCC: Canadian Notice

CC Approval for Canada

This equipment does not exceed the Class A limits for radiated emissions as described in the Radio Interference Regulations of the Canadian Department of Communications.