

BECKHOFF New Automation Technology

Manual | EN

CX2550-0010

Extension Module with CFast Slot



Table of contents

1 Foreword	5
1.1 Notes on the documentation.....	5
1.2 Safety instructions	6
1.3 Documentation issue status	7
2 Product overview	8
2.1 Intended use.....	8
2.2 System overview	9
2.3 CX2550-0010 - Technical data.....	10
3 Unpacking and transport	11
4 Installing the extension module	12
4.1 Installing the extension module at the CX20x0 system	12
4.2 Installing the bar clips	14
4.3 Installation on the mounting rail.....	15
5 Commissioning	18
5.1 Switching on and off	18
5.2 Installing and removing CFast cards	19
5.3 Partitioning storage media	20
5.3.1 Activating the Disk Defragmenter service.....	21
5.3.2 Partitioning.....	22
5.3.3 Deactivating the Disk Defragmenter service.....	24
5.4 Setting up a RAID system	25
5.4.1 Using the Beckhoff USB stick for setting up the system.....	26
5.4.2 Using the Intel Manager for setting up the system	27
5.4.3 Replacing storage media	30
5.4.4 Deleting a RAID system.....	32
5.4.5 Using the recovery mode.....	33
6 Error handling and diagnostics	35
6.1 LEDs of the extension module.....	35
6.2 Faults	35
7 Removal and disposal	36
8 Appendix	38
8.1 Accessories	38
8.2 Certifications.....	39
8.3 Support and Service	40

1 Foreword

1.1 Notes on the documentation

This description is only intended for the use of trained specialists in control and automation engineering who are familiar with applicable national standards.

It is essential that the documentation and the following notes and explanations are followed when installing and commissioning the components.

It is the duty of the technical personnel to use the documentation published at the respective time of each installation and commissioning.

The responsible staff must ensure that the application or use of the products described satisfy all the requirements for safety, including all the relevant laws, regulations, guidelines and standards.

Disclaimer

The documentation has been prepared with care. The products described are, however, constantly under development.

We reserve the right to revise and change the documentation at any time and without prior announcement. No claims for the modification of products that have already been supplied may be made on the basis of the data, diagrams and descriptions in this documentation.

Trademarks

Beckhoff®, TwinCAT®, TwinCAT/BSD®, TC/BSD®, EtherCAT®, EtherCAT G®, EtherCAT G10®, EtherCAT P®, Safety over EtherCAT®, TwinSAFE®, XFC®, XTS® and XPlanar® are registered trademarks of and licensed by Beckhoff Automation GmbH.

Other designations used in this publication may be trademarks whose use by third parties for their own purposes could violate the rights of the owners.

Patent Pending

The EtherCAT Technology is covered, including but not limited to the following patent applications and patents:

EP1590927, EP1789857, EP1456722, EP2137893, DE102015105702
with corresponding applications or registrations in various other countries.

EtherCAT®

EtherCAT® is a registered trademark and patented technology, licensed by Beckhoff Automation GmbH, Germany

Copyright

© Beckhoff Automation GmbH & Co. KG, Germany.

The reproduction, distribution and utilization of this document as well as the communication of its contents to others without express authorization are prohibited.

Offenders will be held liable for the payment of damages. All rights reserved in the event of the grant of a patent, utility model or design.

1.2 Safety instructions

Safety regulations

Please note the following safety instructions and explanations!
Product-specific safety instructions can be found on following pages or in the areas mounting, wiring, commissioning etc.

Exclusion of liability

All the components are supplied in particular hardware and software configurations appropriate for the application. Modifications to hardware or software configurations other than those described in the documentation are not permitted, and nullify the liability of Beckhoff Automation GmbH & Co. KG.

Personnel qualification

This description is only intended for trained specialists in control, automation and drive engineering who are familiar with the applicable national standards.

Description of symbols

In this documentation the following symbols are used with an accompanying safety instruction or note. The safety instructions must be read carefully and followed without fail!

DANGER

Serious risk of injury!

Failure to follow the safety instructions associated with this symbol directly endangers the life and health of persons.

WARNING

Risk of injury!

Failure to follow the safety instructions associated with this symbol endangers the life and health of persons.

CAUTION

Personal injuries!

Failure to follow the safety instructions associated with this symbol can lead to injuries to persons.

NOTE

Damage to the environment or devices

Failure to follow the instructions associated with this symbol can lead to damage to the environment or equipment.



Tip or pointer

This symbol indicates information that contributes to better understanding.

1.3 Documentation issue status

Version	Modifications
1.0	First version
1.1	Chapter Recovery mode added

2 Product overview

2.1 Intended use

The CX20x0 device series is a modular control system designed for DIN rail installation. The system is scalable, so that the required modules can be assembled and installed in the control cabinet or terminal box as required.

Only switch the PC off after closing the software

Before the Embedded PC is switched off, the software currently running on it should be stopped properly in order to avoid data loss on the hard disk. Please read the section on "Switching off".

Switch off all system components and uncouple the Industrial PC from the system if the PC is not used for control purposes, e.g. during a function test. To disconnect first pull the first terminal behind the power supply unit (optional), then pull the connectors of the fieldbus connections. System components that have been switched off must be secured against being switched on again.

The Embedded PC's power supply unit must be supplied with 24 V_{DC}.

NOTE

Damage to the environment or devices

Do not exchange any parts when under power! The exchange of controller parts when live can lead to short-circuits or overvoltages. These can damage the controller itself and connected peripherals (terminals, monitors, input devices, etc.).

When components are being fitted or removed, the supply voltage must be switched off.

Software knowledge

NOTE

System malfunctions

Mandatory software knowledge! Every user must be familiar with any of the functions of the software installed on the PC that he can reach.

2.2 System overview

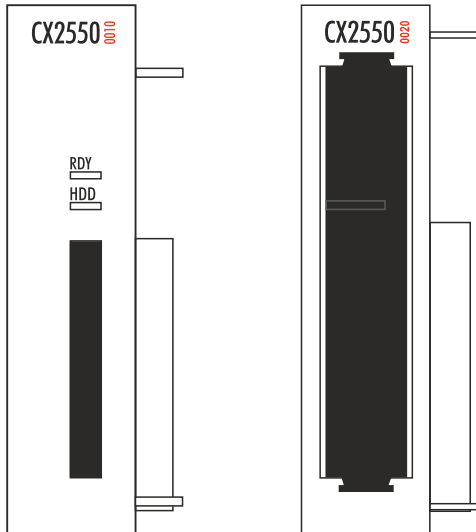

CX2550-00x0 extension modules

The extension modules of type CX2550-xxxx for the CX2000 family are attached to the basic CPU module on the right-hand side via a multi-pin connector and are internally connected via PCI Express. The basic CPU module can accommodate up to two modules, so that up to three storage media are available in total. This expansion capability offers the advantage that a RAID system can be set up when more than one storage medium is used.

The CX2550-0020 extension module features a 2½-inch slot, which is suitable for HDD/SSD storage media with a thickness of up to 9.5 mm. The storage media are installed at the front with the aid of a slide-in frame, so that they can be exchanged quickly and easily. The storage medium is protected by the attachable cap, which latches to the housing of the module. The internal SATA-6G-Port also offers sufficient bandwidth for the latest SSD storage media.

The CX2550-00100 extension module has a CFast slot for CFast cards. Up to two CX2550-0010 CFast modules can be connected, so that a total of up to three CFast slots are available.

2.3 CX2550-0010 - Technical data

Dimensions

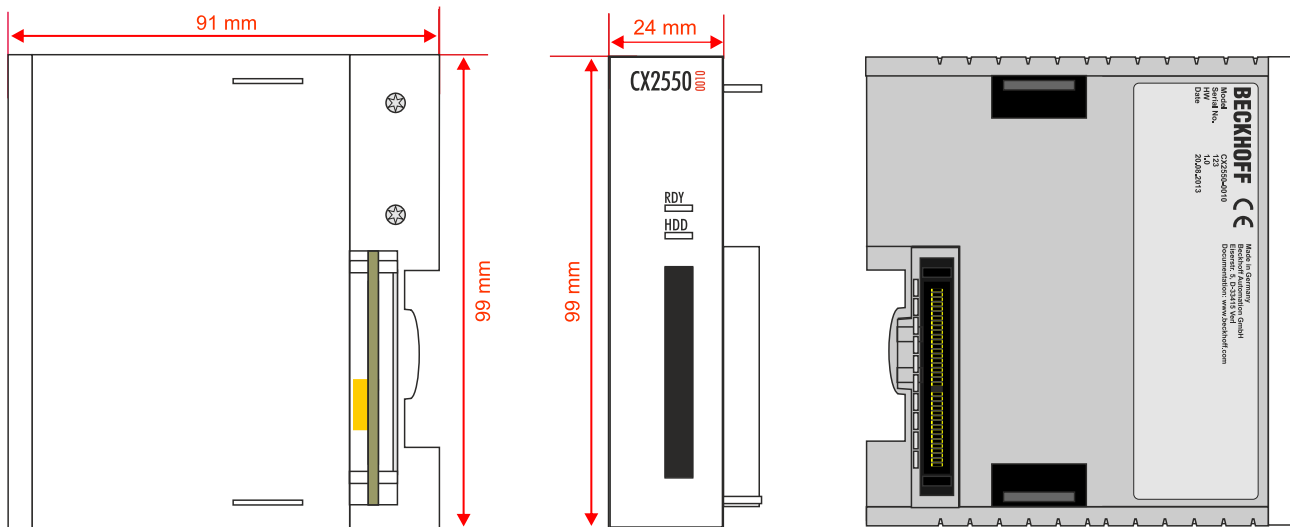

Technical data

Technical data	CX2550-0010
Interfaces	SATA
Connection type	CFast slot
Power supply	via system bus (through CX2100-0xxx power supply modules)
Dimensions (W x H x D)	24 mm x 99 mm x 91 mm
Weight	approx. 280 g (without storage medium)
Operating/storage temperature	-25° C ... +60° C / -40° C ... +85° C
Relative humidity	95 % no condensation
Vibration/shock resistant	conforms to EN 60068-2-6 / EN 60068-2-27
EMC immunity/emission	conforms to EN 61000-6-2 / EN 61000-6-4
Protection class	IP 20

3 Unpacking and transport

● Short circuit due to moisture

i Moisture can lead to short circuits. Moisture can form during transport in cold weather or in the event of large temperature fluctuations.

Avoid moisture formation (condensation) in the device, and leave the device to adjust to room temperature slowly. If condensation has occurred, wait at least 12 hours before switching on the device.

Proceed as follows to unpack the unit:

1. Remove packaging.
2. Do not discard the original packaging. Keep it for transporting the device in the future.
3. Check the delivery for completeness by comparing it with your order.
4. Please keep the associated paperwork. It contains important information for handling the unit.
5. Check the contents for visible shipping damage.
6. If you notice any shipping damage or inconsistencies between the contents and your order, you should notify Beckhoff Service.

Shipping and relocation

Despite the robust design of the unit, the components are sensitive to strong vibrations and impacts. Therefore, during transport please protect your device from:

- mechanical stress and
- use the original packaging.

Follow the specified storage conditions for the device and store it at temperatures between -40 °C and +85 °C.

4 Installing the extension module

● Electrical voltage



Having the power supply switched on during the installation may damage the device.
Switch off the power supply during the installation.

This section contains information on:

- installing the extension module for the basic CX20x0 CPU module;
- interlocking the individual modules with the aid of bar clips and
- installing the extension module on the mounting rail, together with the basic CPU module.

4.1 Installing the extension module at the CX20x0 system

● Damage to the contacts



Incorrect installation may result in damage to the contacts of the extension modules.
The extension modules may only be attached on the right-hand side of the basic CPU module.

A maximum of two extension modules can be attached to the basic CPU module via the internal PCI Express bus. In delivery state the extension module is equipped with a protective cap for the bus connector. Before continuing, connect the extension module to the basic CPU module.

Prerequisites for this step:

- Exit the software and shut down the CX20x0 hardware configuration.
- Switch off the power supply.

Install the extension module as follows:

1. Put a screwdriver into the recess on the short side of the protective cap and lever it off.

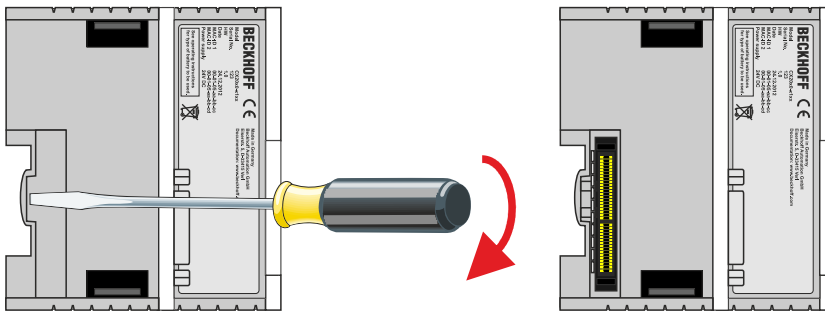

2. Remove the protective cap to expose the bus connector.
3. If a power supply unit is already connected, remove it from the basic CPU module.

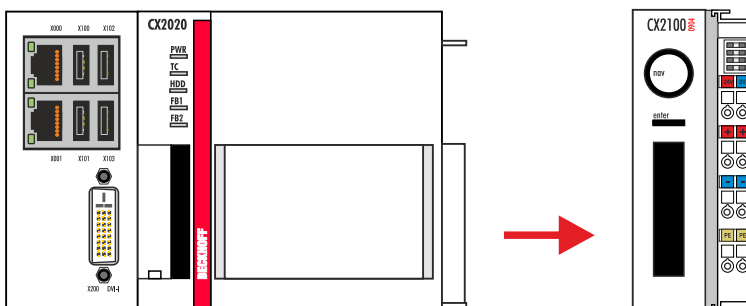

4. Insert the extension module on the **right-hand side of** the basic CPU module, then insert the power supply unit into the extension module.

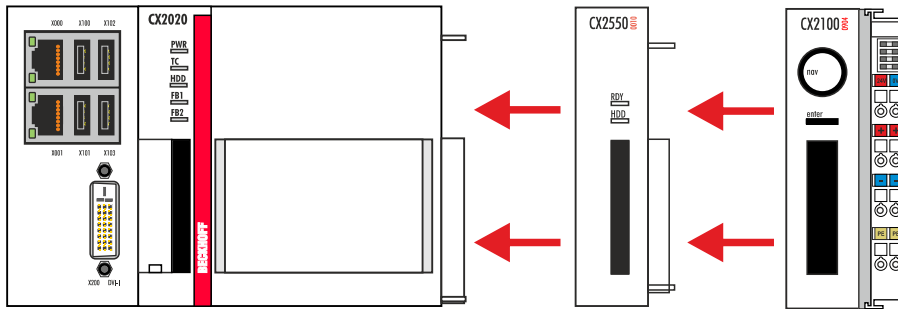

5. The module clicks into the basic CPU module and the power supply unit.

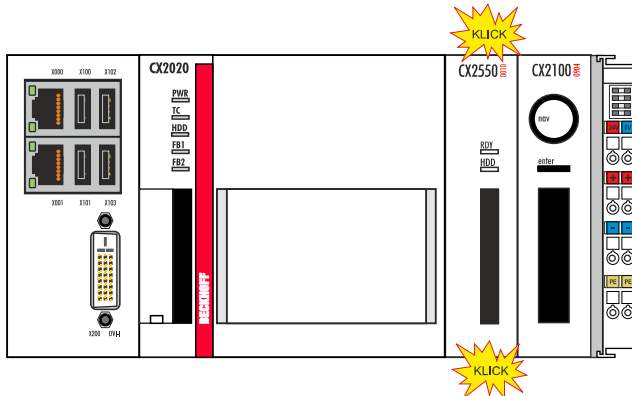

- ⇒ The extension module has been installed successfully, if the individual modules were connected straight and flush.
Next, you can install the bar clips, thereby reinforcing interlocking of the modules.

4.2 Installing the bar clips

Installing the bar clips

Usually, the connection between the modules is strong enough. However, the basic CPU module and the extension modules may be subjected to shocks, vibrations or other impacts. The modules can be securely connected to one another with the aid of bar clips.

Install the bar clips as follows:

1. Attach the bar clips to the top and bottom of the devices.

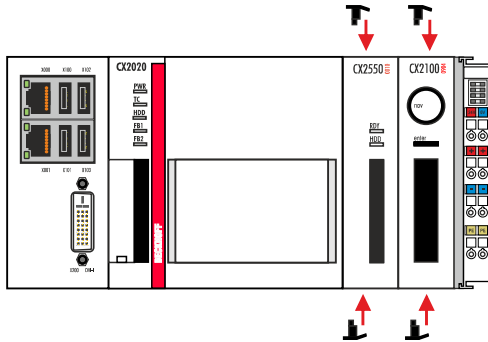

2. Push the bar clips between the cooling fins of your devices, as shown in the image below.



- ⇒ The bar clips have been installed successfully, if they don't protrude and are level with the cooling fins of your modules.
Once all extension modules are locked, the whole assembly can be installed on the mounting rail.

4.3 Installation on the mounting rail

● Installation position and minimum distances

i

The modules or devices may overheat, if the installation position is incorrect or the minimum distances are not adhered to.

The devices may only be operated at ambient temperatures up to 60 °C. Ensure adequate ventilation. Choose a horizontal installation position for the devices. Leave at least 30 mm clearance above and below the installed devices.

Correct installation position

The devices may be operated up to an ambient temperature of 60 °C. The high performance and the compact design of the CX2000 Embedded PC series may result in increased heat generation. The heat is dissipated via a passive ventilation system. Venting of the devices requires a correct installation position.

Ventilation openings are located at the top and bottom of the housing. The system therefore has to be installed horizontally. This ensures optimum airflow through the devices in vertical direction.

During installation, leave at least 30 mm clearance above and below the devices to ensure adequate ventilation.

The images below show the permitted and two unacceptable installation positions:

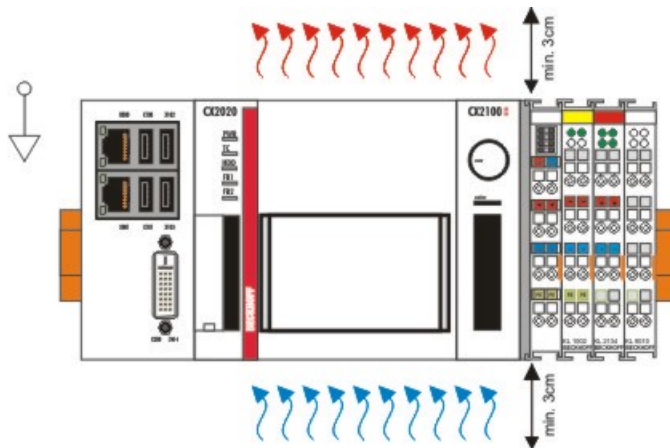

gültige Installationslage
valid position

Incorrect installation positions

The CX20x0 system must not be operated vertically on the DIN rail. This installation position provides insufficient ventilation for the devices. In horizontal position the devices are not sufficiently ventilated either.

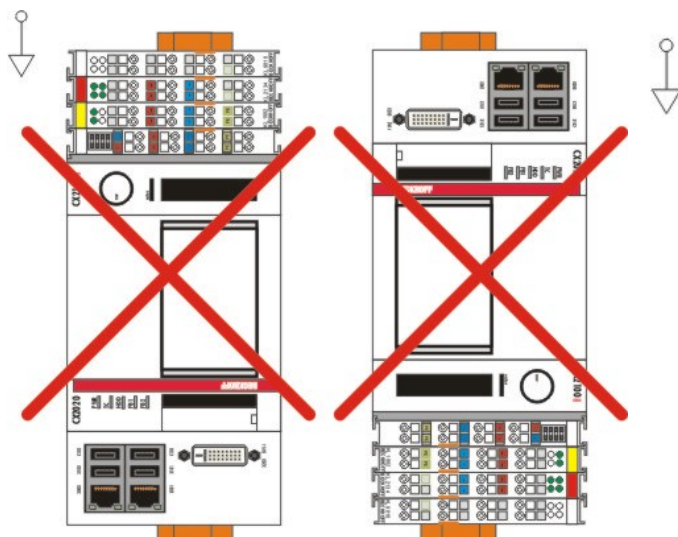

ungültige Installationslage
invalid position



ungültige Installationslage
invalid position

Installation on the mounting rail

● Avoid damage



Do not use force or excessive pressure when installing the devices on the mounting rail.

The CX20x0 can easily be installed on the mounting rail. The housing is designed such that it can be pushed against the mounting rail and engaged on it.

Install the devices on the mounting rail as follows:

1. Unlock the latches at the top and bottom.

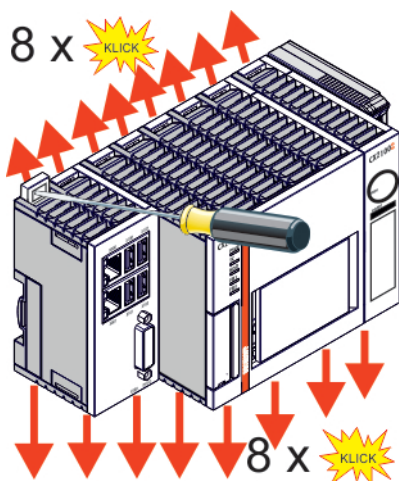

2. Position the devices at the front of the mounting rail. Gently push the devices onto the mounting rail until you can hear a click and the devices are engaged.

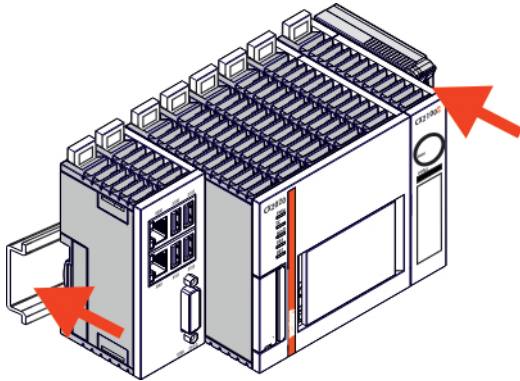

3. Then lock the latches again.

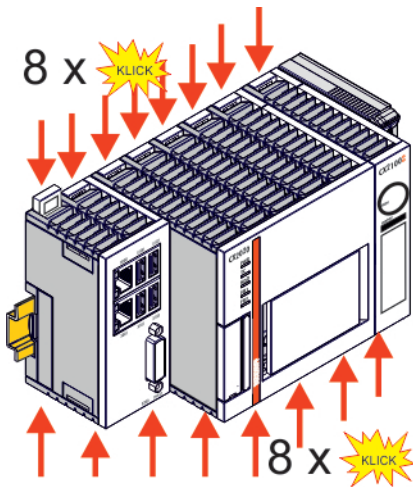

- ⇒ The devices are now installed successfully. Verify that the devices are installed correctly and that all devices are engaged on the mounting rail. In the next step you can commission the devices.

5 Commissioning

This section contains information on:

- switch the extension module on and off together with the basic CPU module,
- install and remove storage media from the extension module,
- partition the storage media and
- set up a RAID system with the aid of the extension module.

5.1 Switching on and off

Switching on

The power supply for the basic CPU module and the extension module comes from the power supply unit. When the power supply unit is connected to the electricity supply, the basic CPU module and the extension module start automatically.

Further information on how to connect the power supply unit to the electricity supply can be found in the following documentation:

<http://beckhoff.de>

Document name
CX20x0 hardware description
CX2100-00x4 power supply unit for CX20x0
CX2100-09x4 UPS power supply unit for CX20x0

Switching on for the first time

When you switch on the PC for the first time, the pre-installed operating system (optional) will be started.

Switching off

The control software typically running on Embedded PCs should be shut down or stopped correctly. A user who is not allowed to terminate the software is also not allowed to switch off the Embedded PC. Switching off while the software is running may lead to loss of data from the hard disk.

Once the software has been stopped, the operating system can be shut down. Only then should the power supply be interrupted. If the electricity supply for the power supply unit is switched off, the basic CPU module and the extension module are also switched off.

5.2 Installing and removing CFast cards

i **Loss of data**

Working with storage media can lead to data loss.

Save your data and switch off the devices before you install or remove storage media.

The extension module CX2550-0010 expands the basic CPU module and makes additional CFast slots available. The CX2550-0010 extension modules can be used for additional storage media to provide additional memory or to set up a RAID system.

How to install a CFast card:

1. Push the contacts side of the CFast card into the housing until it snaps into place.

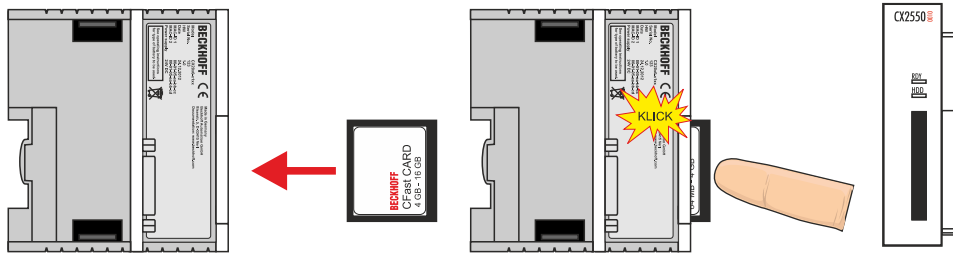

How to remove a CFast card:

1. Push the installed CFast card until you hear a click.
2. The CFast card springs back from the housing and can then be pulled out.

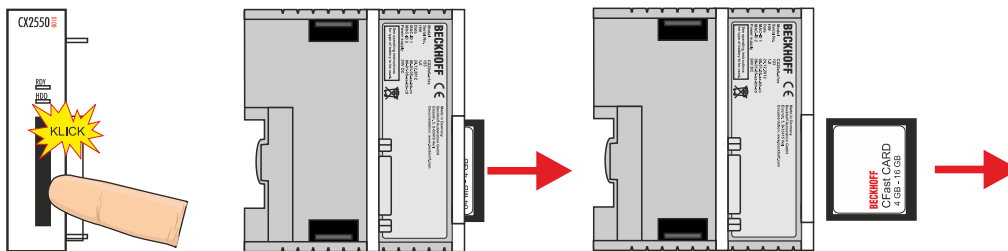

- ⇒ After the CFast card has been installed, it is detected automatically by the basic CPU module and is ready to use.
In the next step you can set up a RAID system.

5.3 Partitioning storage media

This section describes how to partition your storage medium. During partitioning a physical storage medium is subdivided into two or more logic storage media. The partitions are independent and can be treated as independent storage media by the operating system.

Partitioning a storage medium can offer various advantages:

- Several operating systems can be installed on the same storage medium.
- Each partition has its own file system, and it is possible to set up different file systems.
- Data security is enhanced. Partitions with faulty file systems have no effect on other partitions. Partitions may be formatted independently of other partitions.
- Partitions facilitate “housekeeping”. The user can determine which data is stored on which partition. Individual partitions can be dedicated to data backup.

The minimum storage medium size for which partitioning may make sense is 8 GB. Smaller storage media would quickly reach their limits, since the Windows operating system and TwinCAT together occupy approx. 4.45 GB of memory. A partition on a storage medium with a size of less than 8 GB would therefore not provide enough usable memory.

These instructions are intended for Embedded PCs and Industrial PCs with the Windows Embedded Standard (WES) 7 operating system or higher.

The following sections contain further information on:

- activating the Windows Disk Defragmenter service and
- partitioning of your storage media.

5.3.1 Activating the Disk Defragmenter service

By default the Disk Defragmenter service is disabled on Embedded PCs and Industrial PCs. To enable partitioning of a storage medium, the Disk Defragmenter service has to be enabled.

Prerequisites for this step:

- Embedded PC or Industrial PC with Windows Embedded Standard operating system or higher.

Activate the Disk Defragmenter service as follows:

1. In the taskbar click on **Start > Control Panel**.
The Control Panel window opens.
2. Click on **Administrative Tools**, then **Services**.
The Services window opens.

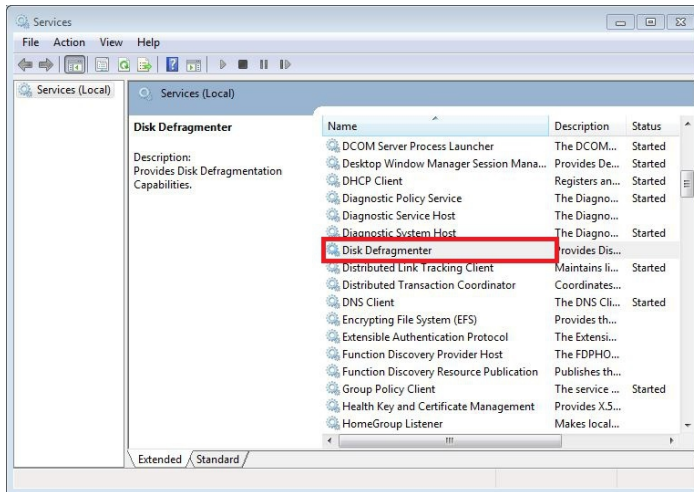

3. Double-click on **Disk Defragmenter**.
The Disk Defragmenter Properties window appears.
4. Under **Startup type** select the option **Automatic** and click **OK**.

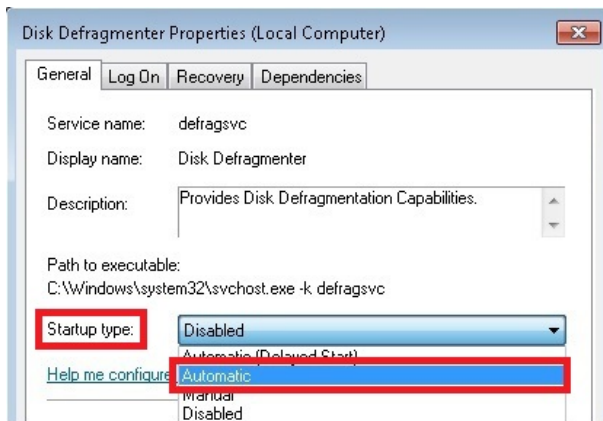

⇒ The Disk Defragmenter service is now enabled. In the next step you can partition a storage medium.

5.3.2 Partitioning

You can partition your storage media with the Disk Management tool. The tool is pre-installed in Windows. The Disk Management tool displays all installed physical storage media and partitions.

Prerequisites for this step:

- The Disk Defragmenter service must be enabled.

Partition your storage media as follows:

1. In the taskbar click on **Start > Control Panel**.
The Control Panel window opens.
2. Click on **Administrative Tools**, then **Computer Management**.
The Computer Management window appears.
3. In the tree view click on **Disk Management**.
The installed storage media are displayed.

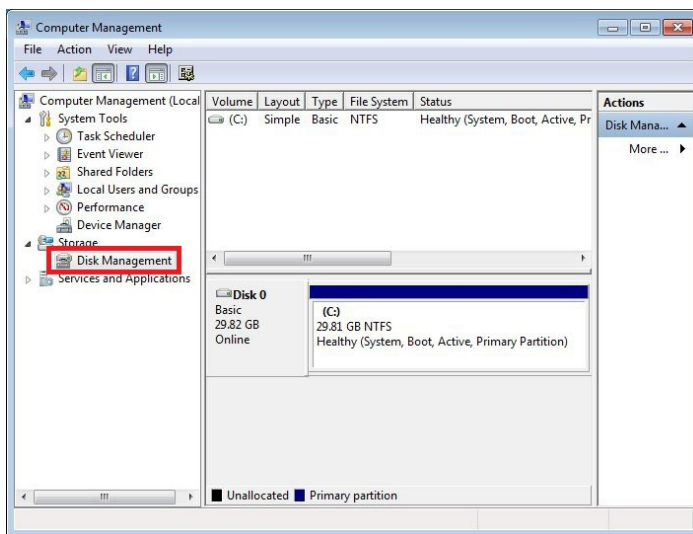

4. Right-click on a storage medium, then click on **Shrink Volume** in the context menu.

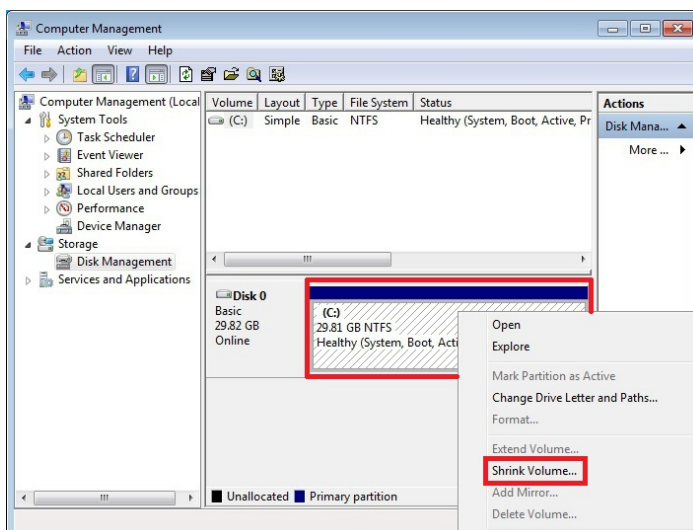

5. Enter the required value for the storage medium size, then click on **Shrink**.

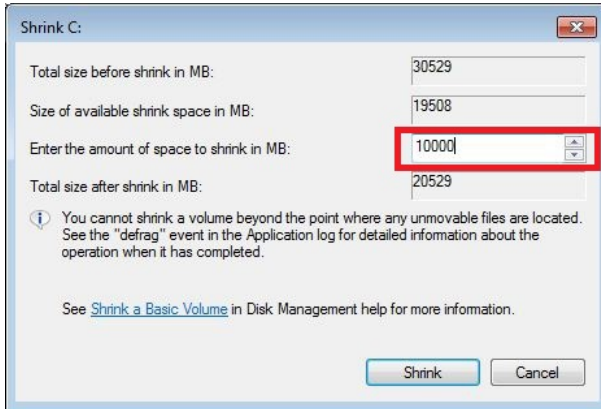

The size of the storage medium is reduced and displayed with a different storage capacity. In addition, a section with non-allocated storage capacity appears.

6. Right-click on the section with non-allocated storage capacity.
7. In the context menu click on **New Simple Volume**.

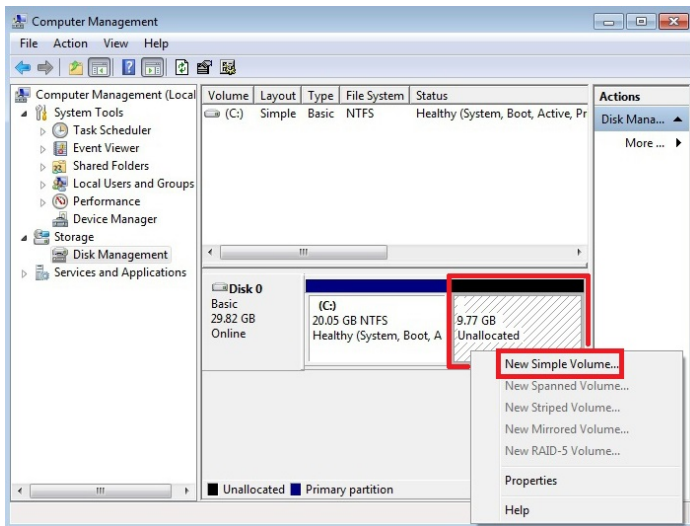

Follow the installation instructions to create a new logic storage medium.

- ⇒ You have now successfully partitioned a storage medium. The new storage medium appears next to the reduced storage medium.

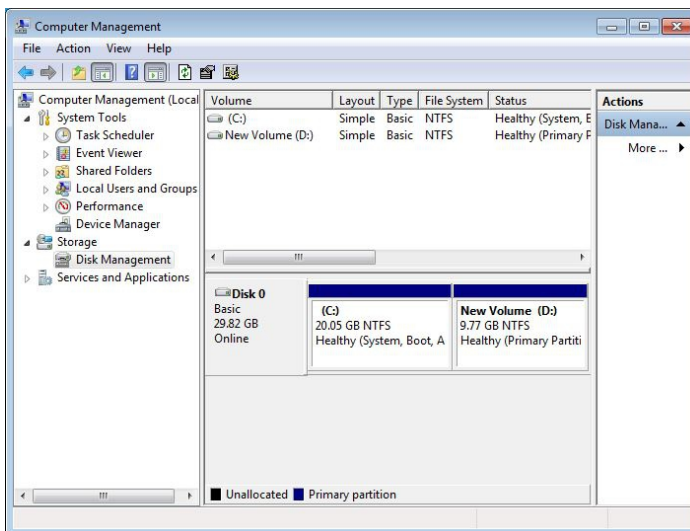

Be sure to disable the Disk Defragmenter service after the partitioning, so that this function is not available to unauthorized users.

5.3.3 Deactivating the Disk Defragmenter service

After successful partitioning, the Disk Defragmenter service should be disabled again, to make it unavailable to unauthorized users and to disable access to the storage media by the service.

Prerequisites for this step:

- Completed partitioning of the storage media.

Deactivate the Disk Defragmenter service as follows:

1. In the taskbar click on **Start > Control Panel**.
The Control Panel window opens.
2. Click on **Administrative Tools**, then **Services**.
The Services window opens.

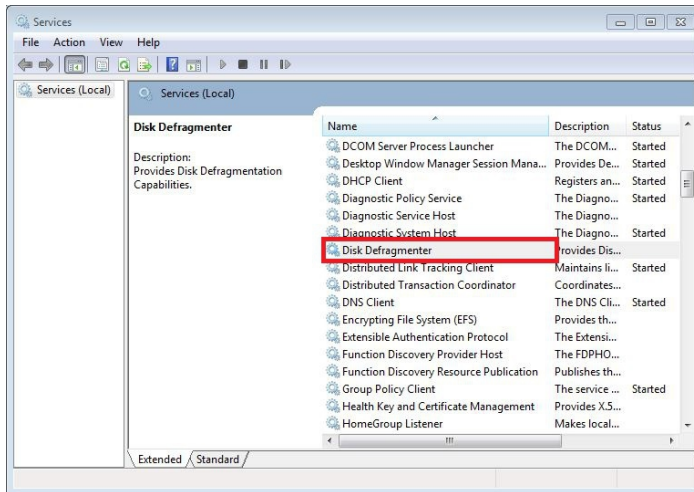

3. Double-click on **Disk Defragmenter**.
The Disk Defragmenter Properties window appears.
4. Under **Startup type** select the option **Disabled** and click **OK**.

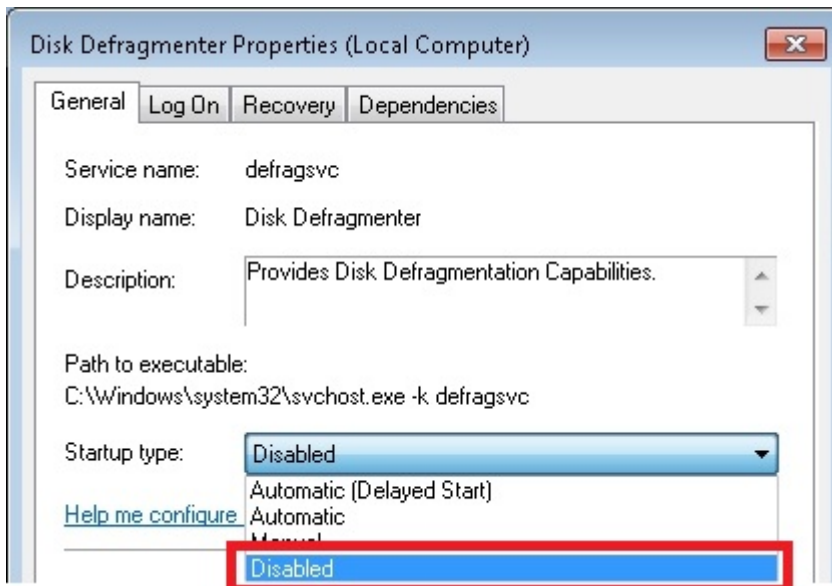

⇒ The Disk Defragmenter service is now disabled.

5.4 Setting up a RAID system

It is possible to set up a RAID system, in order to enhance data security. In a RAID system, physically available storage media, including hard drives or Flash cards, are organized in a logic drive.

On these storage media, redundant information is created in a targeted manner and mirrored to all storage media integrated in the RAID system. If individual storage media fail due to defects, for example, the data is not lost. A faulty storage medium can be replaced with a new one. The data is restored on the new storage medium with the aid of the remaining storage medium. In this way the original state can easily be restored.

The following RAID options can be selected to set up a RAID system:

- RAID 1 (real-time data protection) is used to mirror a storage media. Data is written redundantly on two storage media. If a storage medium fails, it can be replaced. The data is restored on the new storage medium with the aid of the remaining storage medium.
- RAID 0 (optimized disk performance) is used to increase the speed of the storage media. The data is distributed to both storage media but not stored redundantly. The aim is not data security, but maximum write and read speed.
- RAID 5 (efficient data hosting and protection) is used to combine data security and performance. RAID 5 offers data security through redundancy as well as higher data throughput. For this option at least three storage media are required.

● Optimum RAID system

i An inappropriate RAID option can lead to data loss. Ensure optimum data security for your system and the devices used in it.

Only use the RAID 1 option for your RAID system, in order to ensure enhanced data security in case of failure of the storage media.

Recommendations

1. For a RAID system, only the RAID 1 option is recommended and described in the documentation.
2. Make regular backups of your system. Note that a RAID system only protects against hardware failures (storage media). The RAID system does not protect against data corruption, which makes the storage medium unusable.
3. Use an USV so that no corrupt data is written on the storage media during a power failure.
4. Use storage media suitable for industrial use supplied by Beckhoff.

Chapter overview

The following sections describe how to set up a RAID system with the following two methods:

- Using a Beckhoff USB stick with integrated Beckhoff Service Tool (see: [Using the Beckhoff USB stick for setting up the system](#) [▶ 26]).
- Using the Intel Manager, which is pre-installed on your device. This method has the advantage that the image does not have to be reinstalled (see: [Using the Intel Manager for setting up the system](#) [▶ 27]).
- **Special function:** The recovery function protects against data corruption and copies data from a master to a recovery storage medium (see: [Using the recovery mode](#) [▶ 33]). This allows to save valid data on a second storage media and to be restored if required.

5.4.1 Using the Beckhoff USB stick for setting up the system

i Loss of data

In this step the data on the storage media is deleted.
Save your data before continuing.

With this method the RAID system is set up with the aid of a Beckhoff USB stick. The data on the storage medium is mirrored to a second storage medium, which enhances the data security.

Prerequisite for this step:

- Connected Beckhoff USB stick.
- At least two storage media have to be installed in the device.

How to set up a RAID system with the Beckhoff USB stick:

1. Start the device and press & hold **[CTRL + I]** while the device starts up.
The main menu for the RAID settings appears.
 2. Use the **[arrow keys]** (up, down) to select **1. Create RAID Volume**.
The menu **1. Create RAID Volume** appears.
 3. Used the **[tab]** key to select the field **Name** and enter a name for the RAID system.
 4. Under **RAID Level** select the option **RAID 1**.
 5. Use the **[tab]** key to navigate to **Create Volume** and confirm the settings with **[Enter]**.
 6. Acknowledge the data loss warning with **Yes**.
The **MAIN MENU** appears. The RAID system appears with the name you specified, and the RAID system status is displayed as Normal. In addition, the installed storage media are displayed with the status Member Disk.
 7. Use the **[arrow keys]** (up, down) to select **6. Exit**, press **[Enter]** and confirm with **Yes** to exit the RAID settings.
- ⇒ The RAID system was set up successfully. The device restarts and boots from the Beckhoff USB stick. Next, the Beckhoff Service Tool starts, and the image has to be installed on the RAID system. A guide for creating, restoring and installing an image with the Beckhoff Service Tool can be found at: <http://infosys.beckhoff.com> under *Industrial PC\Operating Systems\Accessories*

5.4.2 Using the Intel Manager for setting up the system

i Use identical storage media

In the RAID configuration errors may occur, with the result that functions and the software interface are not displayed properly in the Intel Manager.

Use identical storage media, in order to ensure full functionality.

i Formatting storage media

Errors may occur during the RAID configuration.

First, format the additional storage media you wish to include in the RAID system.

With this method, the RAID system is set up with the Intel Manager. A key advantage of this method is that the image does not have to be reloaded. The Intel Manager is already pre-installed on the device.

Prerequisites for this step:

- At least two storage media have to be installed in the device.

How to set up a RAID system with the Intel Manager:

1. Start the Intel Manager under **Start > All Programs > Intel > Intel Rapid Storage Technology**.
2. In the toolbar click on **Create**.

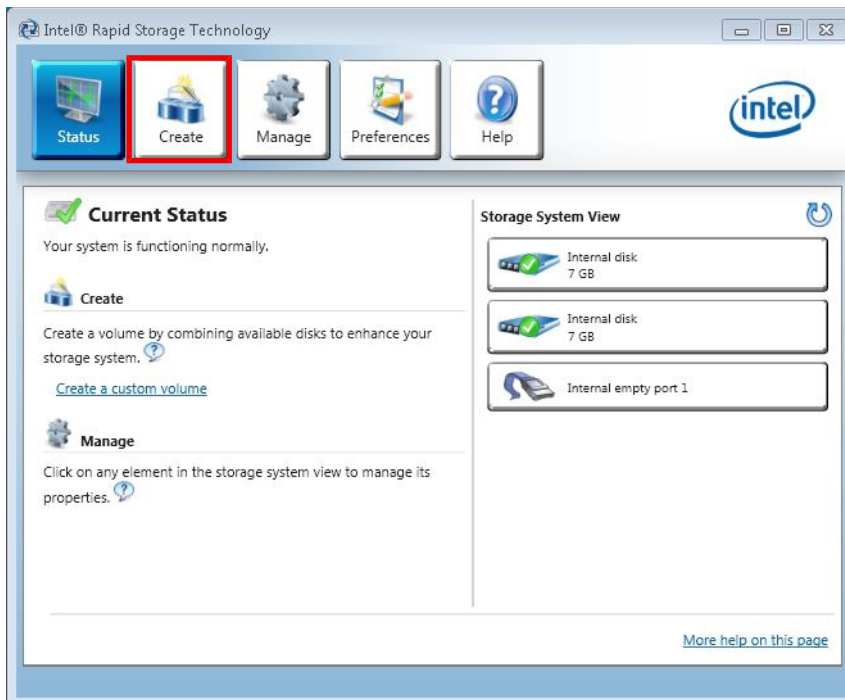

- Under **Select Volume Type** select the option **Real-time data protection (RAID 1)**.

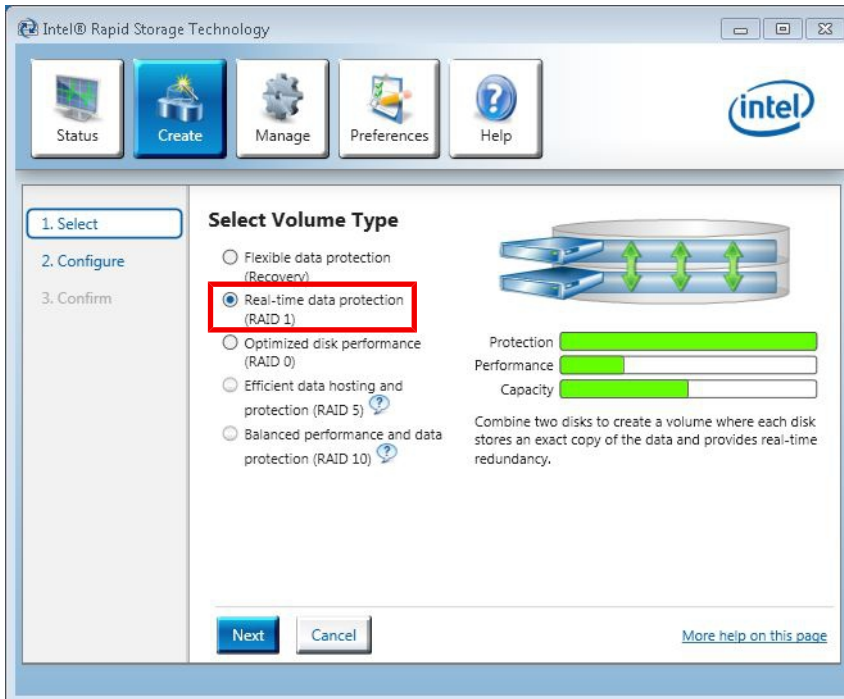

- Click on **Next**.
- In the **Name** field enter a name for the RAID system. Tick the checkboxes **Disk on port 0** and **Disk on port 2**. Select the option **Yes: Disk on port 2** to determine which storage medium is to be mirrored.

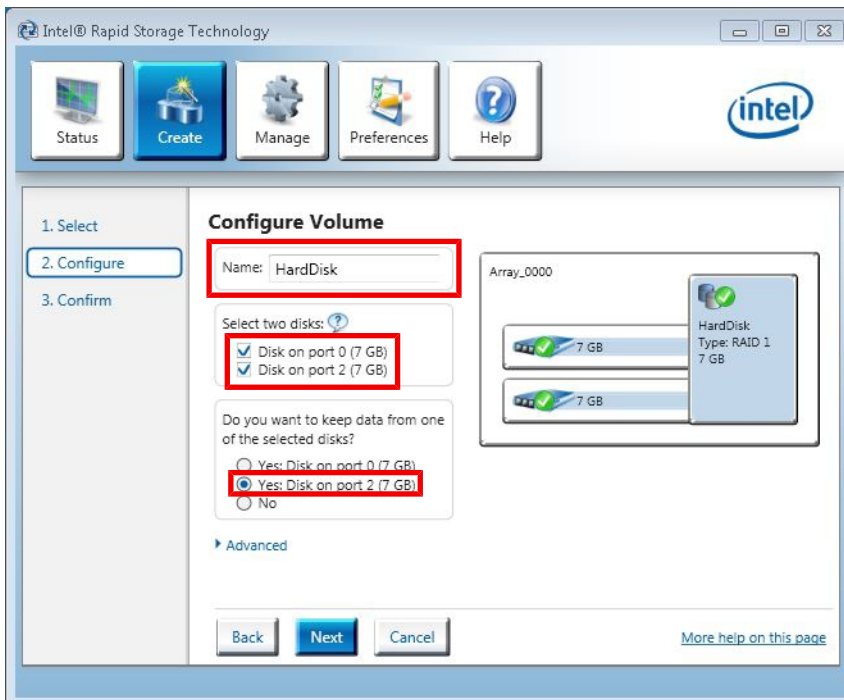

The option **Disk on port 2** matches the system drive C:, on which the image is installed.

- Click on **Next**.

7. Click on **Create Volume** and then **OK** to create the RAID system.

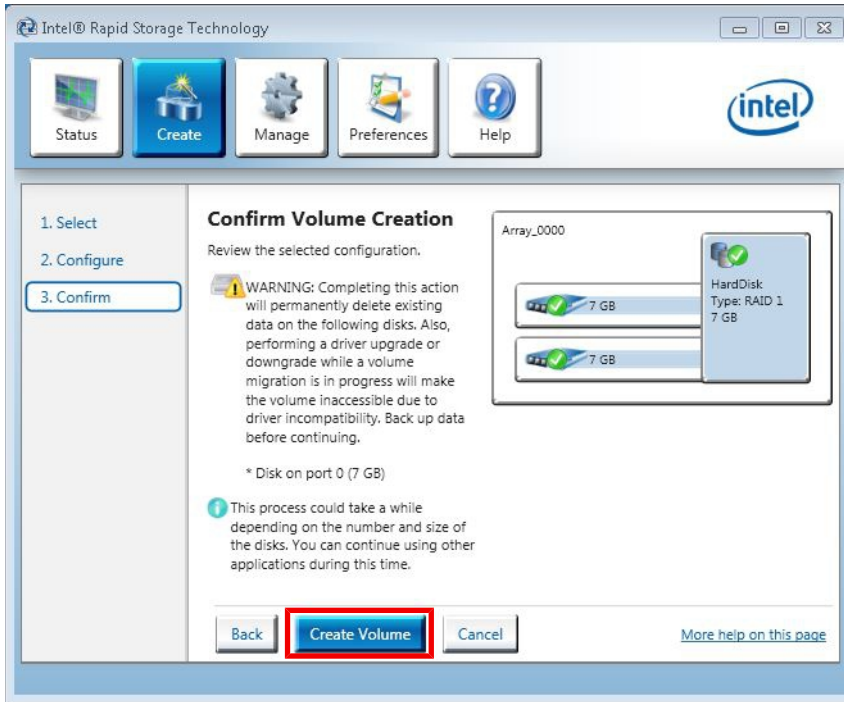

⇒ The RAID system is created. The Intel Manager changes to status view and shows the newly created RAID system and the storage media used. In addition, the progress of the data migration to the second storage medium is displayed in percent.

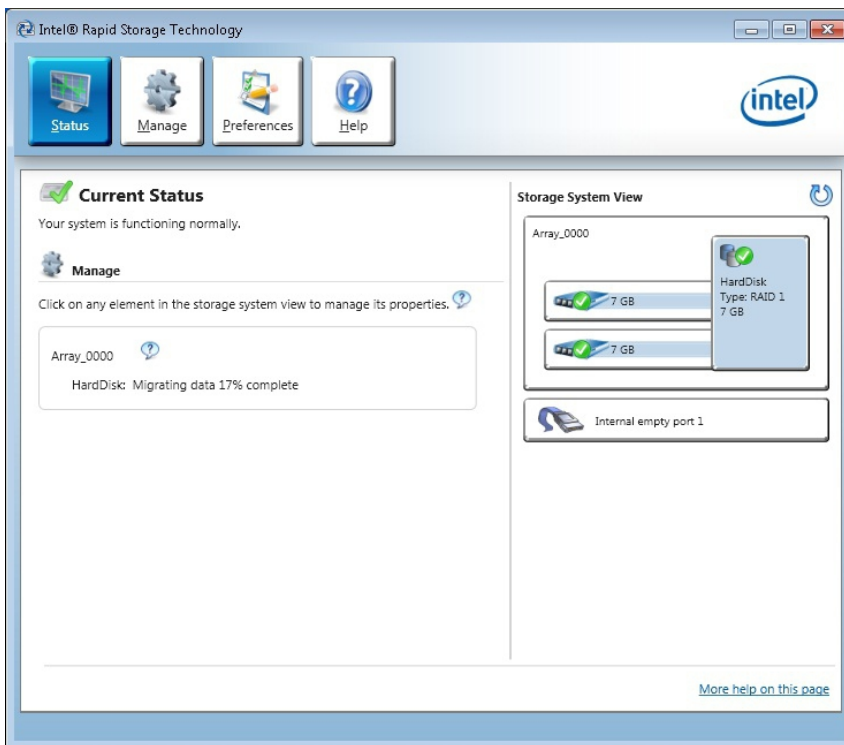

5.4.3 Replacing storage media

If one of your storage media fails during operation, you can restore the RAID system with the aid of the Intel Manager.

Prerequisites for this step:

- Install a new storage medium in the extension module.

How to replace storage media in the RAID system:

1. Start the Intel Manager under **Start > All Programs > Intel > Intel Rapid Storage Technology**. In the program window the available RAID system appears under **Storage System View**. A malfunction is indicated by a warning sign over a faulty or removed storage medium. The new storage medium, which was installed as replacement, is shown below.

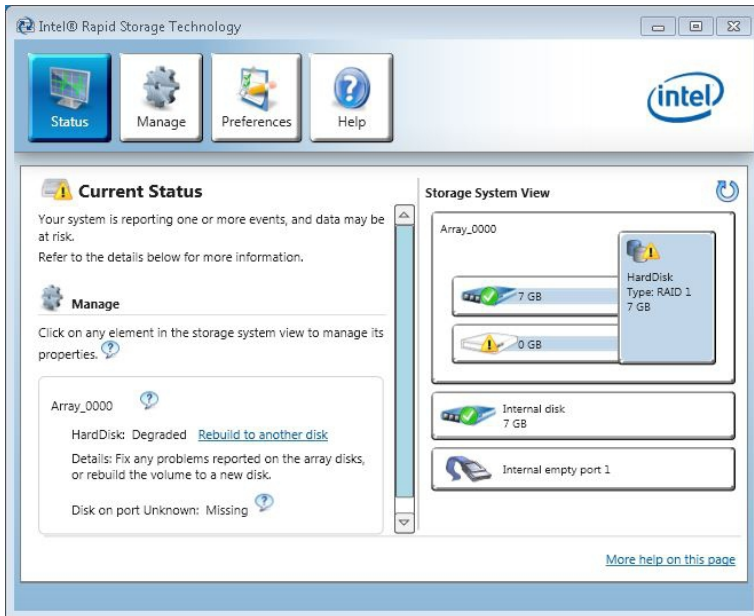

2. Click on **Rebuild to another disk** to integrate the new storage medium in the RAID system.

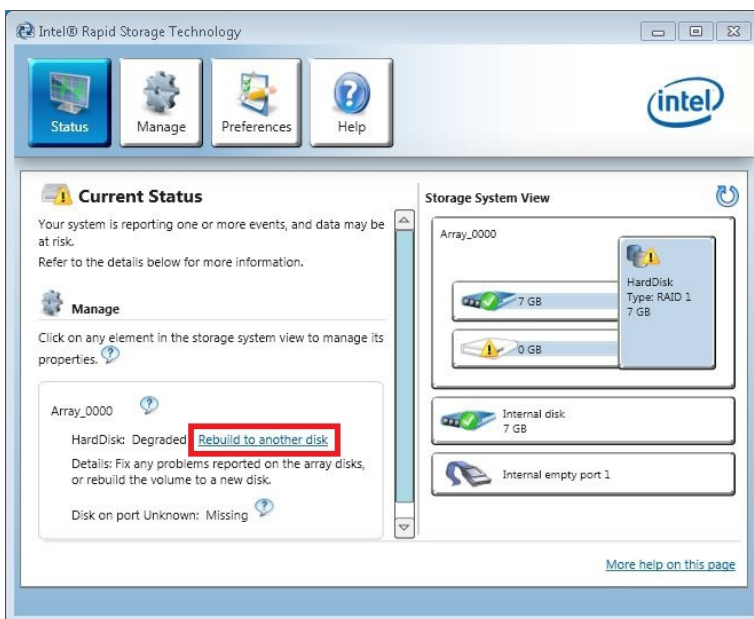

3. Select the option **Disk on port 0** and click on **Rebuild**.

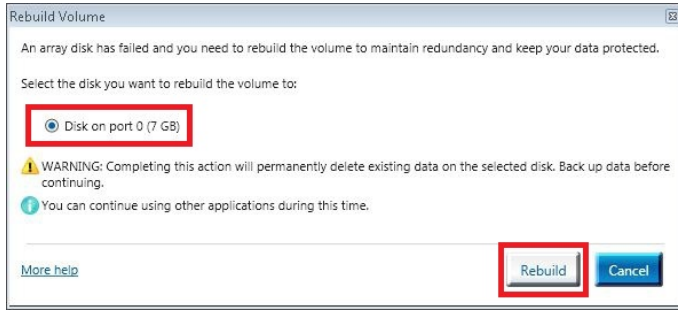

⇒ You have successfully replaced a damaged storage medium and restored the RAID system. The progress of the restoration is indicated in percent.

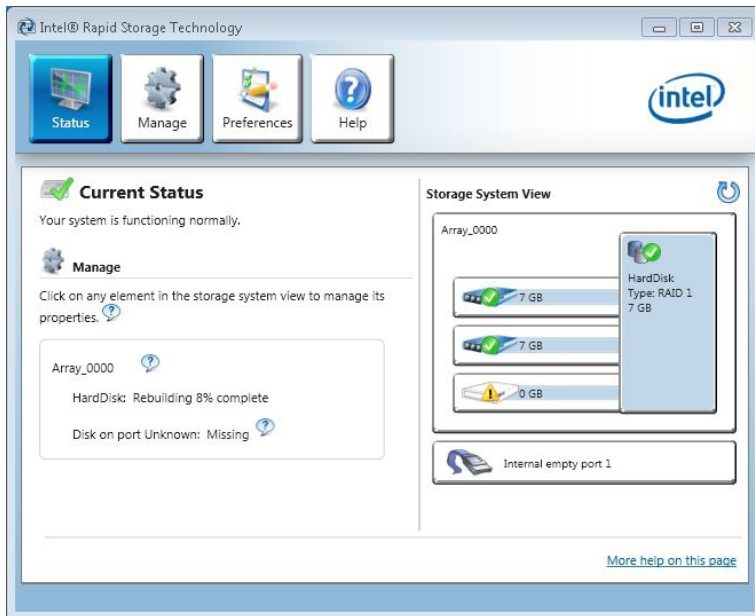

5.4.4 Deleting a RAID system

The RAID system can be deleted, so that the storage media can be operated individually again. No data is lost, if the RAID 1 option was used for your RAID system.

Prerequisites for this step:

- RAID system already installed.

How to delete a RAID system with the Intel Manager:

1. Start the Intel Manager under **Start > All Programs > Intel > Intel Rapid Storage Technology**.
2. In the toolbar click on **Manage**, then **Delete Volume**.

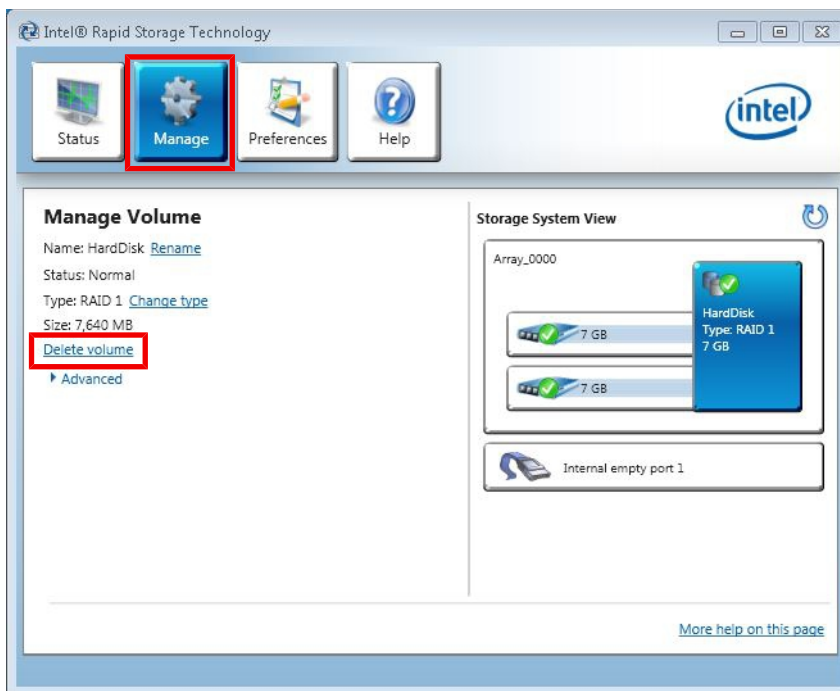

3. Click on **Yes** to acknowledge the warning.

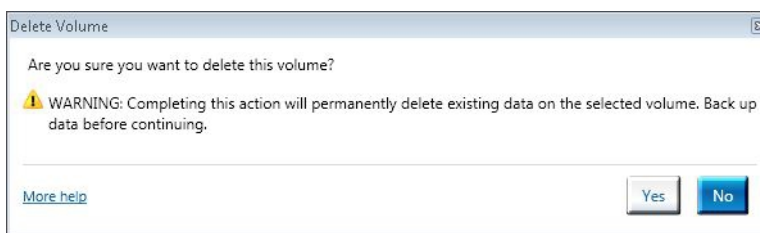

- ⇒ The RAID system was deleted successfully. The storage media are displayed individually in the status overview of the Intel Manager and are no longer part of a RAID system.

5.4.5 Using the recovery mode

In the recovery mode you can create a Recovery system including a master and recovery storage media. The recovery mode combines two storage media and utilizes RAID 1 functionality to copy data from a designated master disk to a designated recovery disk.

Use the **On request mode** for your Recovery system only. In this mode you need to request data updates manually to copy master disk changes to the recovery disk.

Prerequisites for this step:

- At least two storage media have to be installed in the device.

How to set up the recovery mode

1. Start the Intel Manager under **Start > All Programs > Intel > Intel Rapid Storage Technology**.
2. In the toolbar click on **Create**.

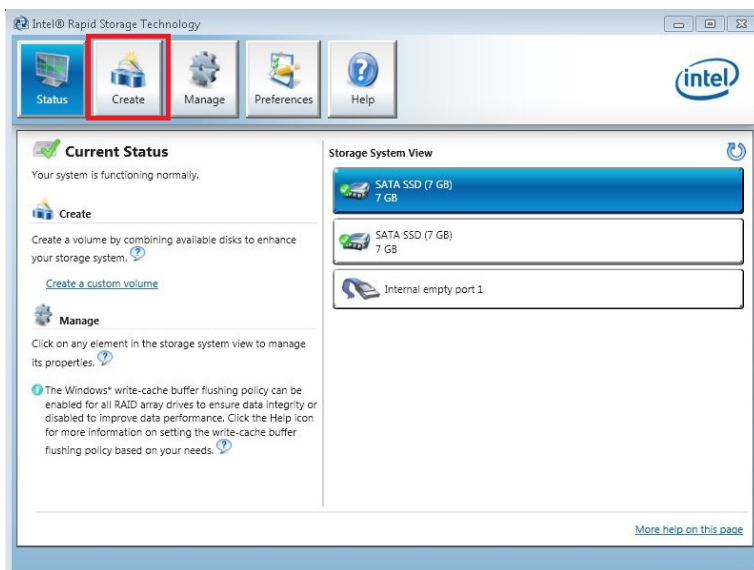

3. Under **Select Volume Type** select the option **Flexible data protection (Recovery)**.

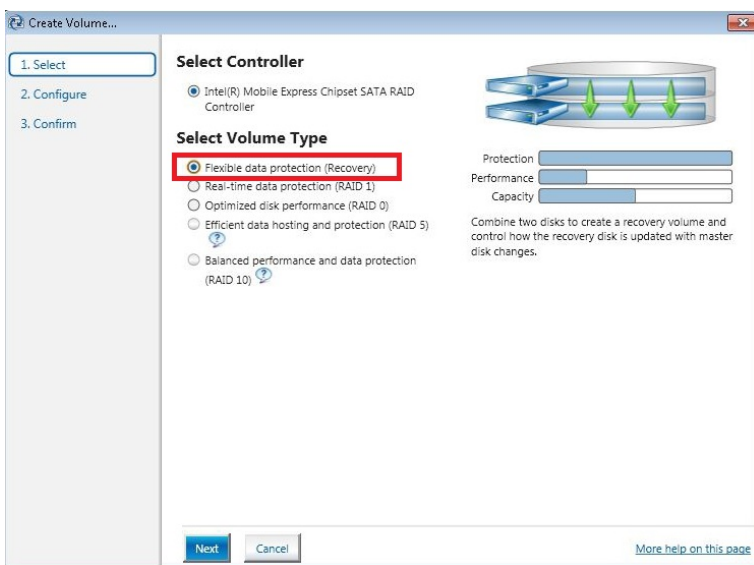

4. Click on **Next**.

5. In the **Name** field enter a name for the Recovery system. Under **Select the master disk** select the option **SATA SSD on Controller 0, Port 2**.
Port 2 is the internal storage media. Port 0 and Port 1 is the external storage media.
6. Under **Select the recovery disk** select the option **SATA SSD on Controller 0, Port 0**.

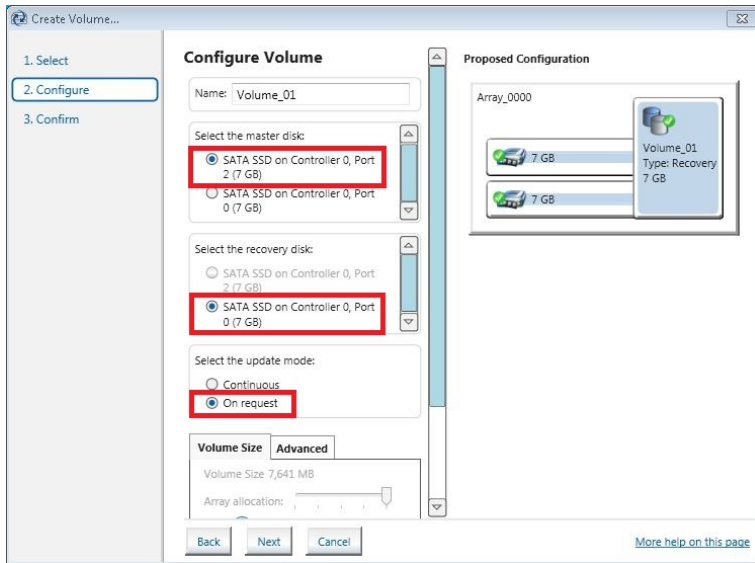

7. Select the update mode **On request**, to manually request data updates and copy changes from the master to the recovery storage media.
8. Click on **Create Volume** and then **OK** to create the Recovery system.

⇒ The Recovery system is created. The Intel Manager changes to status view and shows the newly created Recovery system and the storage media used. In addition, the progress of the data migration to the Recovery storage medium is displayed in percent.

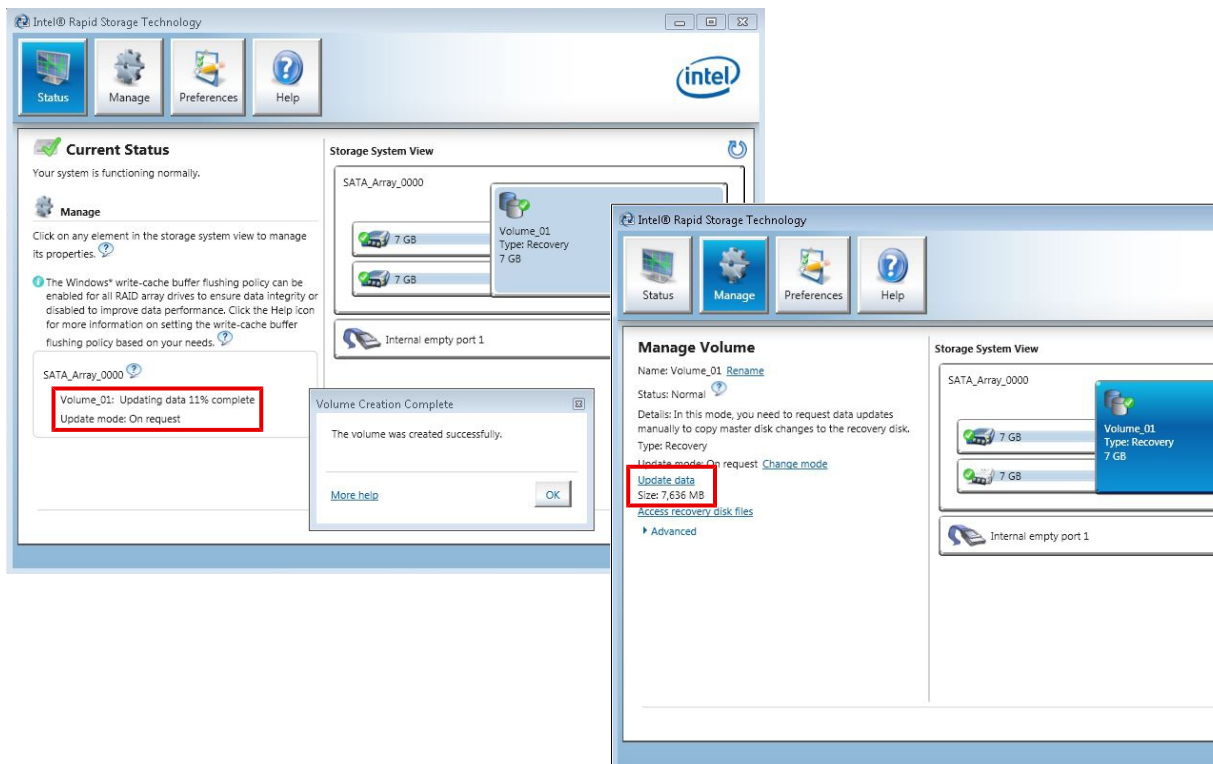

Click on **Update data** to manually copy data from master to the recovery storage media.

6 Error handling and diagnostics

6.1 LEDs of the extension module

The LEDs of the extension module CX2550-0010 have the following meaning:

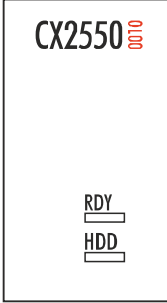
Display	LED	Meaning
	RDY	Status display (green). The LED is green if a CFast card is installed.
	HDD	Read/Write CFast (red). Red indicates that the CFast card is currently accessed.

6.2 Faults

Please also refer to the Safety instructions section.

Possible faults and their correction

Fault	Cause	Measures
no function after the Embedded PC has been switched on	no power supply for the Embedded PC other causes	1. Check the fuse 2. Measure voltage at connection, check plug wiring, call Beckhoff support
Embedded PC does not boot fully	Hard disk damaged (e.g. due to switching off while software is running), incorrect setup, other causes	Check setup Call Beckhoff Support
Computer boots, software starts, but control does not operate correctly	Cause of the fault is either in the software or in parts of the plant outside the Embedded PC	Call the manufacturer of the machine or the software.
CF card access error	Faulty CFast card, faulty CFast slot	Use a different CFast card to check the CFast slot Call Beckhoff Support
Embedded PC only works partially or temporarily	Defective components in the Embedded PC	Call Beckhoff support

Please make a note of the following information **before** contacting Beckhoff service or support:

1. Precise device ID: CXxxxx-xxxx
2. Serial number
3. Hardware version
4. Any interfaces (N030, N031, B110, ...)
5. TwinCAT version used
6. Any components / software used

The quickest response will come from support / service in your country. Therefore please contact your regional contact. For details please refer to our website at www.beckhoff.de or ask your distribution partner.

7 Removal and disposal

● Electrical voltage

i Having the power supply switched on during the installation may damage the device.
Switch off the power supply during the installation.

● Cabling

i Make a note of the wiring configuration, if you wish to restore it with another device.

The CX2000 Embedded PC series is a modular system and enables individual modules to be replaced or removed quite easily. This section describes how to remove devices from the CX2000 Embedded PC series.

Prerequisites for this step:

- Exit the software and shut down the CX20x0 hardware configuration.
- Disconnect the power supply.

Remove the devices as follows:

1. Remove the wiring from the basic CPU module, any system interfaces that may be connected and the extension modules.
2. Remove the wiring from the first terminal next to the power supply unit.
3. Pull the orange tab to remove the terminal.

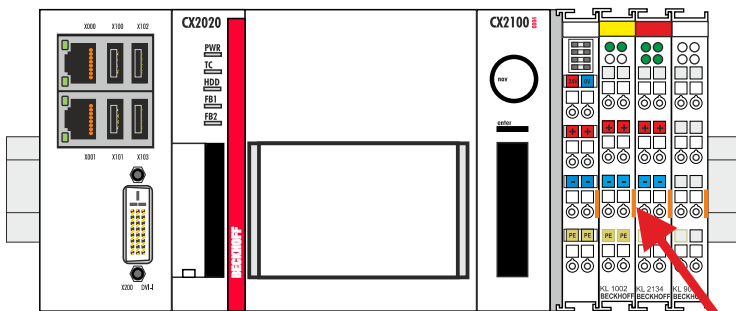

4. Release the DIN rail mounting by pushing the latches outwards with a screwdriver.

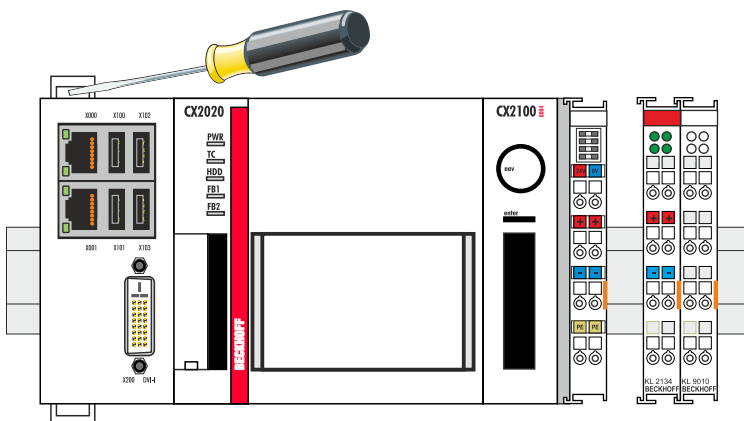

5. Pull the orange tab on the power supply unit and gently remove the device from the DIN rail.

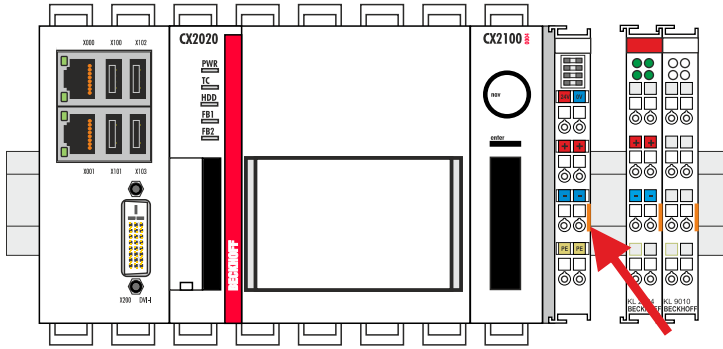

Next, you can remove the bar clips, in order to release the modules.

Removing the bar clips

In order to dismantle the assembly it must first be removed from the support rail. The bar clips can then be removed with the aid of a screwdriver.

Remove the bar clips as follows:

1. Lift the bar clips with the aid of a screwdriver and remove the bar clips.

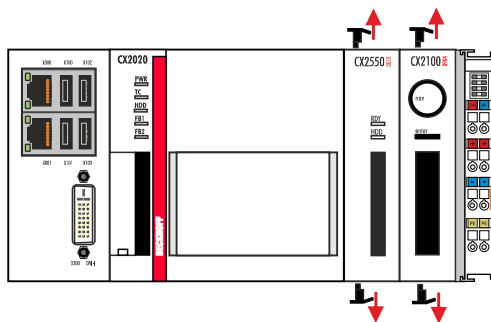
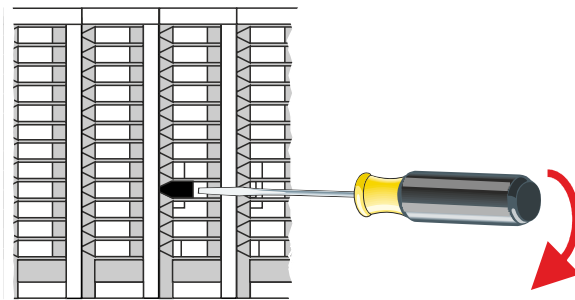

Once the bar clips have been removed successfully, the modules can be separated from each other.

Disposal

The device must be fully dismantled in order to dispose of it.

Electronic components must be disposed of according to national electronic waste regulations

8 Appendix

8.1 Accessories

Table 1: CFast cards

Order number	Description
CX2900-0026	20 GB CFast card, 3D flash, extended temperature range
CX2900-0038	40 GB CFast card, 3D flash, extended temperature range
CX2900-0040	80 GB CFast card, 3D flash, extended temperature range
CX2900-0042	160 GB CFast card, 3D flash, extended temperature range

8.2 Certifications

FCC Approvals for the United States of America

FCC: Federal Communications Commission Radio Frequency Interference Statement

This equipment has been tested and found to comply with the limits for a Class A digital device, pursuant to Part 15 of the FCC Rules. These limits are designed to provide reasonable protection against harmful interference when the equipment is operated in a commercial environment. This equipment generates, uses, and can radiate radio frequency energy and, if not installed and used in accordance with the instruction manual, may cause harmful interference to radio communications. Operation of this equipment in a residential area is likely to cause harmful interference in which case the user will be required to correct the interference at his own expense.

FCC Approval for Canada

FCC: Canadian Notice

This equipment does not exceed the Class A limits for radiated emissions as described in the Radio Interference Regulations of the Canadian Department of Communications.

8.3 Support and Service

Beckhoff and their partners around the world offer comprehensive support and service, making available fast and competent assistance with all questions related to Beckhoff products and system solutions.

Beckhoff's branch offices and representatives

Please contact your Beckhoff branch office or representative for local support and service on Beckhoff products!

The addresses of Beckhoff's branch offices and representatives round the world can be found on her internet pages: <https://www.beckhoff.com>

You will also find further documentation for Beckhoff components there.

Beckhoff Support

Support offers you comprehensive technical assistance, helping you not only with the application of individual Beckhoff products, but also with other, wide-ranging services:

- support
- design, programming and commissioning of complex automation systems
- and extensive training program for Beckhoff system components

Hotline: +49 5246 963 157
Fax: +49 5246 963 9157
e-mail: support@beckhoff.com

Beckhoff Service

The Beckhoff Service Center supports you in all matters of after-sales service:

- on-site service
- repair service
- spare parts service
- hotline service

Hotline: +49 5246 963 460
Fax: +49 5246 963 479
e-mail: service@beckhoff.com

Beckhoff Headquarters

Beckhoff Automation GmbH & Co. KG

Huelshorstweg 20
33415 Verl
Germany

Phone: +49 5246 963 0
Fax: +49 5246 963 198
e-mail: info@beckhoff.com
web: <https://www.beckhoff.com>

More Information:
www.beckhoff.com/CX2550-0010

Beckhoff Automation GmbH & Co. KG
Hülshorstweg 20
33415 Verl
Germany
Phone: +49 5246 9630
info@beckhoff.com
www.beckhoff.com

