

Documentation | EN

CU1521-xxxx, CU1561

EtherCAT Media Converter (RJ45, LWL, POF, SFP)



Table of contents

1 Foreword	5
1.1 CU15x1 - Product overview	5
1.2 Notes on the documentation	6
1.3 Guide through documentation	7
1.4 Safety instructions	8
1.5 Documentation issue status	9
1.6 Version identification of EtherCAT devices	10
1.6.1 General notes on marking	10
1.6.2 Version identification of CU Infrastructure Components	11
1.6.3 Beckhoff Identification Code (BIC)	12
1.6.4 Electronic access to the BIC (eBIC).....	14
2 Product description	16
2.1 CU1521 (Multimode) , CU1521-0010 (Singlemode) , CU1561 (POF)	16
2.1.1 Introduction	16
2.1.2 Technical data	18
2.1.3 Diagnostic LEDs.....	19
2.2 CU1521-0020 (Infrastructure, media converter, 3-port junction, Ethernet/EtherCAT, 1000/100 Mbit/s, 24 V DC, SFP).....	20
2.2.1 Introduction	20
2.2.2 Technical data	21
2.2.3 Diagnostic LEDs.....	22
3 Basic principles	23
3.1 EtherCAT basics	23
3.2 EtherCAT cabling – wire-bound	23
3.3 EtherCAT State Machine	24
4 Mounting and wiring	26
4.1 Dimensions	26
4.2 Mounting and demounting.....	27
4.3 UL notice	28
5 Commissioning/application notes	29
5.1 Application notes	29
5.2 Notes on converters with RJ45 fiber-optic connection	34
5.2.1 Principles of fiber-optic technology	35
5.2.2 Notes on suitable optical fiber cables.....	40
5.2.3 Application with CU1521 and CU1521-0010.....	41
5.2.4 Connecting and disconnecting the fiber cable	42
5.3 Notes on converters with RJ45 POF connection	44
5.3.1 Notes regarding suitable POF cables	44
5.3.2 Connecting and disconnecting the POF cable	45
5.4 Notes regarding assembly of POF cables with the connector set ZS1090-0008	47
6 Appendix	51
6.1 Safety instructions and behavioral rules for Class 1 laser	51
6.2 Firmware compatibility	52

6.3 Support and Service..... 53

1 Foreword

1.1 CU15x1 - Product overview

Product designation	Description
CU1521 [▶ 16]	Infrastructure, media converter, Ethernet/EtherCAT, 100 Mbit/s, 24 V DC, fiber optic multi-mode
CU1521-0010 [▶ 16]	Infrastructure, media converter, Ethernet/EtherCAT, 100 Mbit/s, 24 V DC, fiber optic single-mode
CU1521-0020 [▶ 20]	Infrastructure, media converter, 3-port junction, Ethernet/EtherCAT, 1000/100 Mbit/s, 24 V DC, SFP
CU1561 [▶ 16]	Infrastructure, media converter, Ethernet/EtherCAT, 100 Mbit/s, 24 V DC, fiber optic POF

1.2 Notes on the documentation

Intended audience

This description is only intended for the use of trained specialists in control and automation engineering who are familiar with the applicable national standards.

It is essential that the documentation and the following notes and explanations are followed when installing and commissioning these components.

The qualified personnel is obliged to always use the currently valid documentation.

The responsible staff must ensure that the application or use of the products described satisfy all the requirements for safety, including all the relevant laws, regulations, guidelines and standards.

Disclaimer

The documentation has been prepared with care. The products described are, however, constantly under development.

We reserve the right to revise and change the documentation at any time and without prior announcement.

No claims for the modification of products that have already been supplied may be made on the basis of the data, diagrams and descriptions in this documentation.

Trademarks

Beckhoff®, TwinCAT®, TwinCAT/BSD®, TC/BSD®, EtherCAT®, EtherCAT G®, EtherCAT G10®, EtherCAT P®, Safety over EtherCAT®, TwinSAFE®, XFC®, XTS® and XPlanar® are registered trademarks of and licensed by Beckhoff Automation GmbH. Other designations used in this publication may be trademarks whose use by third parties for their own purposes could violate the rights of the owners.

Patent Pending

The EtherCAT Technology is covered, including but not limited to the following patent applications and patents: EP1590927, EP1789857, EP1456722, EP2137893, DE102015105702 with corresponding applications or registrations in various other countries.



EtherCAT® is registered trademark and patented technology, licensed by Beckhoff Automation GmbH, Germany.

Copyright

© Beckhoff Automation GmbH & Co. KG, Germany.

The reproduction, distribution and utilization of this document as well as the communication of its contents to others without express authorization are prohibited.

Offenders will be held liable for the payment of damages. All rights reserved in the event of the grant of a patent, utility model or design.

1.3 Guide through documentation

NOTICE



Further components of documentation

This documentation describes device-specific content. It is part of the modular documentation concept for Beckhoff I/O components. For the use and safe operation of the device / devices described in this documentation, additional cross-product descriptions are required, which can be found in the following table.

Title	Description
EtherCAT System Documentation (PDF)	<ul style="list-style-type: none">• System overview• EtherCAT basics• Cable redundancy• Hot Connect• EtherCAT devices configuration

The documentations can be viewed at and downloaded from the Beckhoff website (www.beckhoff.com) via:

- the “Documentation and Download” area of the respective product page,
- the [Download finder](#),
- the [Beckhoff Information System](#).

1.4 Safety instructions

Safety regulations

Please note the following safety instructions and explanations!
Product-specific safety instructions can be found on following pages or in the areas mounting, wiring, commissioning etc.

Exclusion of liability

All the components are supplied in particular hardware and software configurations appropriate for the application. Modifications to hardware or software configurations other than those described in the documentation are not permitted, and nullify the liability of Beckhoff Automation GmbH & Co. KG.

Personnel qualification

This description is only intended for trained specialists in control, automation and drive engineering who are familiar with the applicable national standards.

Signal words

The signal words used in the documentation are classified below. In order to prevent injury and damage to persons and property, read and follow the safety and warning notices.

Personal injury warnings

⚠ DANGER

Hazard with high risk of death or serious injury.

⚠ WARNING

Hazard with medium risk of death or serious injury.

⚠ CAUTION

There is a low-risk hazard that could result in medium or minor injury.

Warning of damage to property or environment

NOTICE

The environment, equipment, or data may be damaged.

Information on handling the product



This information includes, for example:
recommendations for action, assistance or further information on the product.

1.5 Documentation issue status

Version	Modifications
2.9	<ul style="list-style-type: none"> • Update chapter "Product description" • Update chapter "Diagnosis" • Update chapter "Firmware compatibility"
2.8	<ul style="list-style-type: none"> • Update chapter "Introduction" • Update structure
2.7	<ul style="list-style-type: none"> • Update chapter Technical Data • Update structure
2.6	<ul style="list-style-type: none"> • CU1521-0020 added • Update chapter "Commissioning" • Update structure
2.5	<ul style="list-style-type: none"> • Update chapter "Commissioning" • Update structure
2.4	<ul style="list-style-type: none"> • Update chapter "Notes on converters with RJ45 fiber-optic connection" • Update structure
2.3	<ul style="list-style-type: none"> • Update chapter "Commissioning" • Update Technical Data • Update structure
2.2	<ul style="list-style-type: none"> • Update Technical Data • Update structure
2.1	<ul style="list-style-type: none"> • Update Technical Data • Update structure
2.0	<ul style="list-style-type: none"> • Migration
1.2	<ul style="list-style-type: none"> • Update chapter "Technical data"
1.1	<ul style="list-style-type: none"> • Update chapter "Application notes"
1.0	<ul style="list-style-type: none"> • Addenda and 1st public issue
0.3	<ul style="list-style-type: none"> • Addenda
0.2	<ul style="list-style-type: none"> • Addenda
0.1	<ul style="list-style-type: none"> • Preliminary version

1.6 Version identification of EtherCAT devices

1.6.1 General notes on marking

Designation

A Beckhoff EtherCAT device has a 14-digit designation, made up of

- family key
- type
- version
- revision

Example	Family	Type	Version	Revision
EL3314-0000-0016	EL terminal 12 mm, non-pluggable connection level	3314 4-channel thermocouple terminal	0000 basic type	0016
ES3602-0010-0017	ES terminal 12 mm, pluggable connection level	3602 2-channel voltage measurement	0010 high-precision version	0017
CU2008-0000-0000	CU device	2008 8-port fast ethernet switch	0000 basic type	0000

Notes

- The elements mentioned above result in the **technical designation**. EL3314-0000-0016 is used in the example below.
- EL3314-0000 is the order identifier, in the case of “-0000” usually abbreviated to EL3314. “-0016” is the EtherCAT revision.
- The **order identifier** is made up of
 - family key (EL, EP, CU, ES, KL, CX, etc.)
 - type (3314)
 - version (-0000)
- The **revision** -0016 shows the technical progress, such as the extension of features with regard to the EtherCAT communication, and is managed by Beckhoff.
In principle, a device with a higher revision can replace a device with a lower revision, unless specified otherwise, e.g. in the documentation.
Associated and synonymous with each revision there is usually a description (ESI, EtherCAT Slave Information) in the form of an XML file, which is available for download from the Beckhoff web site.
From 2014/01 the revision is shown on the outside of the IP20 terminals, see Fig. “EL5021 EL terminal, standard IP20 IO device with batch number and revision ID (since 2014/01)”.
- The type, version and revision are read as decimal numbers, even if they are technically saved in hexadecimal.

1.6.2 Version identification of CU Infrastructure Components

The serial number/ data code for Beckhoff IO devices is usually the 8-digit number printed on the device or on a sticker. The serial number indicates the configuration in delivery state and therefore refers to a whole production batch, without distinguishing the individual modules of a batch.

Structure of the serial number: **KK YY FF HH**

KK - week of production (CW, calendar week)

YY - year of production

FF - firmware version

HH - hardware version

Example with serial number 12 06 3A 02:

12 - production week 12

06 - production year 2006

3A - firmware version 3A

02 - hardware version 02

CU1521

EtherCAT media
converter, multimode
fiber optic



BTN: 00007su0

Ser. No.: 4820/

Made in GERMANY



Fig. 1: CU1521 switch with serial number 4820/ and the unique Beckhoff Traceability Number (BTN) 00007su0

1.6.3 Beckhoff Identification Code (BIC)

The Beckhoff Identification Code (BIC) is increasingly being applied to Beckhoff products to uniquely identify the product. The BIC is represented as a Data Matrix Code (DMC, code scheme ECC200), the content is based on the ANSI standard MH10.8.2-2016.

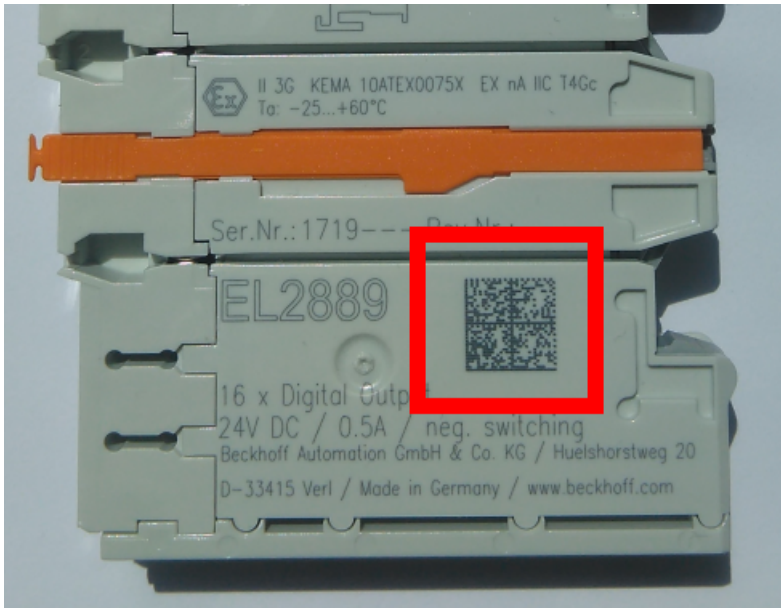

Fig. 2: BIC as data matrix code (DMC, code scheme ECC200)

The BIC will be introduced step by step across all product groups.

Depending on the product, it can be found in the following places:

- on the packaging unit
- directly on the product (if space suffices)
- on the packaging unit and the product

The BIC is machine-readable and contains information that can also be used by the customer for handling and product management.

Each piece of information can be uniquely identified using the so-called data identifier (ANSI MH10.8.2-2016). The data identifier is followed by a character string. Both together have a maximum length according to the table below. If the information is shorter, spaces are added to it.

Following information is possible, positions 1 to 4 are always present, the other according to need of production:

Position	Type of information	Explanation	Data identifier	Number of digits incl. data identifier	Example
1	Beckhoff order number	Beckhoff order number	1P	8	1P 072222
2	Beckhoff Traceability Number (BTN)	Unique serial number, see note below	SBTN	12	SBTN k4p562d7
3	Article description	Beckhoff article description, e.g. EL1008	1K	32	1K EL1809
4	Quantity	Quantity in packaging unit, e.g. 1, 10, etc.	Q	6	Q 1
5	Batch number	Optional: Year and week of production	2P	14	2P 401503180016
6	ID/serial number	Optional: Present-day serial number system, e.g. with safety products	51S	12	51S 678294
7	Variant number	Optional: Product variant number on the basis of standard products	30P	32	30P F971, 2*K183
...					

Further types of information and data identifiers are used by Beckhoff and serve internal processes.

Structure of the BIC

Example of composite information from positions 1 to 4 and with the above given example value on position 6. The data identifiers are highlighted in bold font:

1P072222**SBTN**k4p562d7**1K**EL1809 **Q**1 **51S**678294

Accordingly as DMC:



Fig. 3: Example DMC **1P**072222**SBTN**k4p562d7**1K**EL1809 **Q**1 **51S**678294

BTN

An important component of the BIC is the Beckhoff Traceability Number (BTN, position 2). The BTN is a unique serial number consisting of eight characters that will replace all other serial number systems at Beckhoff in the long term (e.g. batch designations on IO components, previous serial number range for safety products, etc.). The BTN will also be introduced step by step, so it may happen that the BTN is not yet coded in the BIC.

NOTICE

This information has been carefully prepared. However, the procedure described is constantly being further developed. We reserve the right to revise and change procedures and documentation at any time and without prior notice. No claims for changes can be made from the information, illustrations and descriptions in this information.

1.6.4 Electronic access to the BIC (eBIC)

Electronic BIC (eBIC)

The Beckhoff Identification Code (BIC) is applied to the outside of Beckhoff products in a visible place. If possible, it should also be electronically readable.

The interface that the product can be electronically addressed by is crucial for the electronic readout.

K-bus devices (IP20, IP67)

Currently, no electronic storage or readout is planned for these devices.

EtherCAT devices (IP20, IP67)

All Beckhoff EtherCAT devices have an ESI-EEPROM which contains the EtherCAT identity with the revision number. The EtherCAT slave information, also colloquially known as the ESI/XML configuration file for the EtherCAT master, is stored in it. See the corresponding chapter in the EtherCAT system manual ([Link](#)) for the relationships.

Beckhoff also stores the eBIC in the ESI-EEPROM. The eBIC was introduced into Beckhoff IO production (terminals, box modules) in 2020; as of 2023, implementation is largely complete.

The user can electronically access the eBIC (if present) as follows:

- With all EtherCAT devices, the EtherCAT master (TwinCAT) can read the eBIC from the ESI-EEPROM
 - From TwinCAT 3.1 build 4024.11, the eBIC can be displayed in the online view.
 - To do this, check the "Show Beckhoff Identification Code (BIC)" checkbox under EtherCAT → Advanced Settings → Diagnostics:

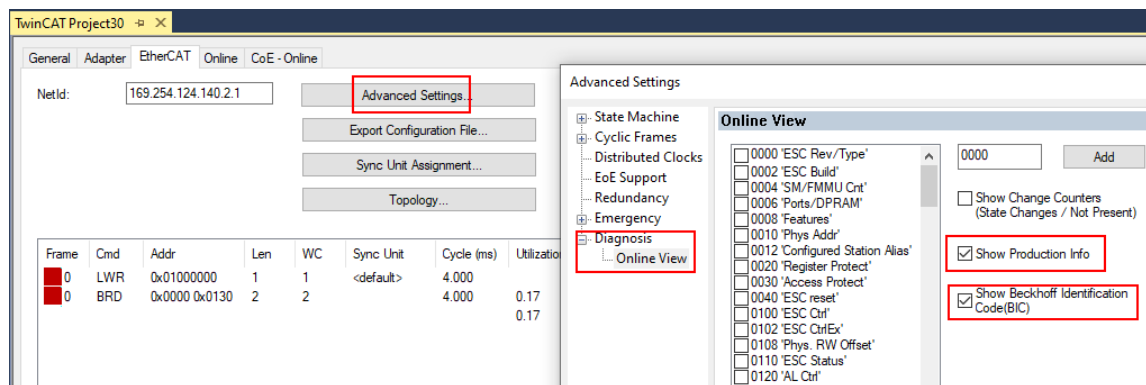

- The BTN and its contents are then displayed:

No	Addr	Name	State	CRC	Fw	Hw	Production Data	ItemNo	BTN	Description	Quantity	BatchNo	SerialNo
1	1001	Term 1 (EK1100)	OP	0.0	0	0	---						
2	1002	Term 2 (EL1018)	OP	0.0	0	0	2020 KW36 Fr	072222	k4p562d7	EL1809	1		678294
3	1003	Term 3 (EL3204)	OP	0.0	7	6	2012 KW24 Sa						
4	1004	Term 4 (EL2004)	OP	0.0	0	0	---	072223	k4p562d7	EL2004	1		678295
5	1005	Term 5 (EL1008)	OP	0.0	0	0	---						
6	1006	Term 6 (EL2008)	OP	0.0	0	12	2014 KW14 Mo						
7	1007	Term 7 (EK1110)	OP	0	1	8	2012 KW25 Mo						

- Note: As shown in the figure, the production data HW version, FW version, and production date, which have been programmed since 2012, can also be displayed with "Show production info".
- Access from the PLC: From TwinCAT 3.1. build 4024.24, the functions *FB_EcReadBIC* and *FB_EcReadBTN* for reading into the PLC are available in the *Tc2_EtherCAT* library from v3.3.19.0.
- EtherCAT devices with a CoE directory may also have the object 0x10E2:01 to display their own eBIC, which can also be easily accessed by the PLC:

- The device must be in PREOP/SAFEOP/OP for access:

Index	Name	Flags	Value
1000	Device type	RO	0x015E1389 (22942601)
1008	Device name	RO	ELM3704-0000
1009	Hardware version	RO	00
100A	Software version	RO	01
100B	Bootloader version	RO	J0.1.27.0
1011:0	Restore default parameters	RO	> 1 <
1018:0	Identity	RO	> 4 <
10E2:0	Manufacturer-specific Identification C...	RO	> 1 <
10E2:01	SubIndex 001	RO	1P158442SBTN0008jckp1KELM3704 Q1 2P482001000016
10F0:0	Backup parameter handling	RO	> 1 <
10F3:0	Diagnosis History	RO	> 21 <
10F8	Actual Time Stamp	RO	0x170bfb277e

- The object 0x10E2 will be preferentially introduced into stock products in the course of necessary firmware revision.
- From TwinCAT 3.1. build 4024.24, the functions *FB_EcCoEReadBIC* and *FB_EcCoEReadBTN* for reading into the PLC are available in the *Tc2_EtherCAT* library from v3.3.19.0
- The following auxiliary functions are available for processing the BIC/BTN data in the PLC in *Tc2_Uilities* as of TwinCAT 3.1 build 4024.24
 - *F_SplitBIC*: The function splits the Beckhoff Identification Code (BIC) *sBICValue* into its components using known identifiers and returns the recognized substrings in the *ST_SplittedBIC* structure as a return value
 - *BIC_TO_BTN*: The function extracts the BTN from the BIC and returns it as a return value
- Note: If there is further electronic processing, the BTN is to be handled as a string(8); the identifier "SBTN" is not part of the BTN.
- Technical background
 The new BIC information is written as an additional category in the ESI-EEPROM during device production. The structure of the ESI content is largely dictated by the ETG specifications, therefore the additional vendor-specific content is stored using a category in accordance with the ETG.2010. ID 03 tells all EtherCAT masters that they may not overwrite these data in the event of an update or restore the data after an ESI update.
 The structure follows the content of the BIC, see here. The EEPROM therefore requires approx. 50..200 bytes of memory.
- Special cases
 - If multiple hierarchically arranged ESCs are installed in a device, only the top-level ESC carries the eBIC information.
 - If multiple non-hierarchically arranged ESCs are installed in a device, all ESCs carry the eBIC information.
 - If the device consists of several sub-devices which each have their own identity, but only the top-level device is accessible via EtherCAT, the eBIC of the top-level device is located in the CoE object directory 0x10E2:01 and the eBICs of the sub-devices follow in 0x10E2:nn.

PROFIBUS; PROFINET, and DeviceNet devices

Currently, no electronic storage or readout is planned for these devices.

2 Product description

2.1 CU1521 (Multimode) , CU1521-0010 (Singlemode) , CU1561 (POF)

2.1.1 Introduction



Fig. 4: CU1521, CU1521-0010, CU1561

The EtherCAT-capable CU1521, CU1521-0010 and CU1561 devices should be used as media converter for industrial fast Ethernet/100 Mbaud from optical fiber to copper and vice versa.

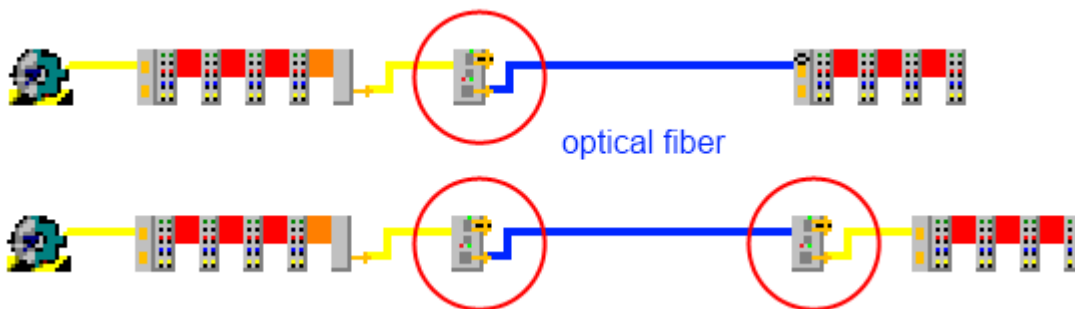

Fig. 5: Upper picture: one media converter, copper -> fiber optic,
Lower picture: two media converters, copper -> fiber optic -> copper

From the physical layer perspective the CU1521 is suitable for multimode, while the CU1521-0010 is suitable for single mode optical fiber and therefore for significantly longer transmission links up to 20 km. The CU1561 is used for interfacing with POF (plastic optical fiber), which are suitable for small-scale machine installation thanks to relatively inexpensive cable material and field-configurability.

The media converter operates bidirectionally and collision-free. The CU15x1 devices are therefore also suitable as media converters for any Ethernet traffic. They support "Link Loss Forwarding", which means that, if the link fails at the outgoing strand, for example due to a broken wire, the link is also withdrawn from the incoming line, so that the sending device is notified of the link loss.

The CU15x1 devices are characterized by the fact that they support the requirements of an EtherCAT network for a converter particularly well. This includes fast link control (establishment and disconnection), diagnosis of communication errors, constant frame deceleration and readable identity (no transparent operation). If the CU15x1 is set to EtherCAT mode with the rotary switch, it can be diagnosed as a separate EtherCAT device. Hence, as opposed to standard media converters, he also ensures fast link control and thus the secure termination of an EtherCAT strand even in the event of a disruption. Since the transfer direction (copper \rightarrow optical fiber or optical fibers \rightarrow copper) is relevant for the EtherCAT bus, the operating direction can be configured via the rotary switch.

The CU15x1 are useful in applications where EtherCAT transfers over large distances are required or where higher EMC loads on the bus line are to be expected.

Quick links

- [EtherCAT basics](#)
- [Application notes](#)
- [Diagnostic LEDs](#) [▶](#) [19](#)

2.1.2 Technical data

Technical data	CU1521	CU1521-0010	CU1561
Function Ethernet "IP"	Media converter Fast Ethernet/100Mbaud (all IEEE 802.3-based protocols) IEEE 802.3u auto negotiation, half or full duplex, automatic settings Link Loss-Forwarding (notification direction configurable) Store and Forward Mode (FIFO) unmanaged		
Function EtherCAT "EC"	Media converter Fast Ethernet/100Mbaud Cut-through mode Port handling/link control		
Number of Ethernet ports	2		
Ethernet interface X1	100BASE-FX multimode glass fiber 50/125 µm (MM) typically 1300 nm 1 x SC Duplex	100BASE-FX single mode glass fiber 9/125 µm (SM) typically 1300 nm 1 x SC Duplex	100BASE-FX-POF glass fiber 980/1000 µm (POF); typically 650 nm 1 x versatile link for POF duplex connector (connector set ZS1090-0008) Laser class 1, see note ▶_51
Ethernet interface X2	10BASE-T/100BASE-TX Ethernet/EtherCAT cable (min. CAT 5), screened RJ45		
Cable length X1 max.	max. 2 km (100BASE-FX)	max. 20 km (100BASE-FX)	max. 50 m (100BASE-FX-POF)
Minimum output power (opt.)	62,5/125 µm, NA = 0,275: -20 dBm avg. 50/125 µm, NA = 0,2: -23,5 dBm avg.	-15 dBm (until year of manufacture 2022) -5 dBm (from year of manufacture 2023)	NA = 0,5: -13,5 dBm
Min. necessary optical input power (sensitivity)	-31 dBm	-25 dBm (until year of manufacture 2022) -35 dBm (from year of manufacture 2023)	-26 dBm
Cable length X2 max.	up to 100 m twisted pair CAT5 (e)		
Diagnostics	LED: Supply voltage, link/activity X1/X2 EtherCAT: CRC		
Power supply	via three-pole spring loaded terminal (+, -, PE)		
Supply voltage	24 V _{DC} (18 V _{DC} to 30 V _{DC}), protected against polarity reversal.		
Current consumption	typ. 95 mA	typ. 80 mA	typ. 60 mA
Weight	approx. 105 g		
Dimensions without plugs (W x H x D)	approx. 34 mm x 98 mm x 77 mm		
Mounting ▶_27	on 35 mm mounting rail (mounting rail according to EN 60715)		
Permissible ambient temperature range during operation	-25°C ... +60°C (extended temperature range)	0°C ... +55°C	
Permissible ambient temperature range during storage	-40°C ... +85°C	-25°C ... +85°C	
Permissible relative humidity	95 %, no condensation		
Vibration/shock resistance	conforms to EN 60068-2-6 / EN 60068-2-27, EN 60068-2-29		
EMC immunity/emission	conforms to EN 61000-6-2 / EN 61000-6-4		
Protection class	IP20		
Installation position	variable		
Marking / Approval ¹⁾	CE, UKCA cULus ▶_28		

*) Real applicable approvals/markings see type plate on the side (product marking).

2.1.3 Diagnostic LEDs

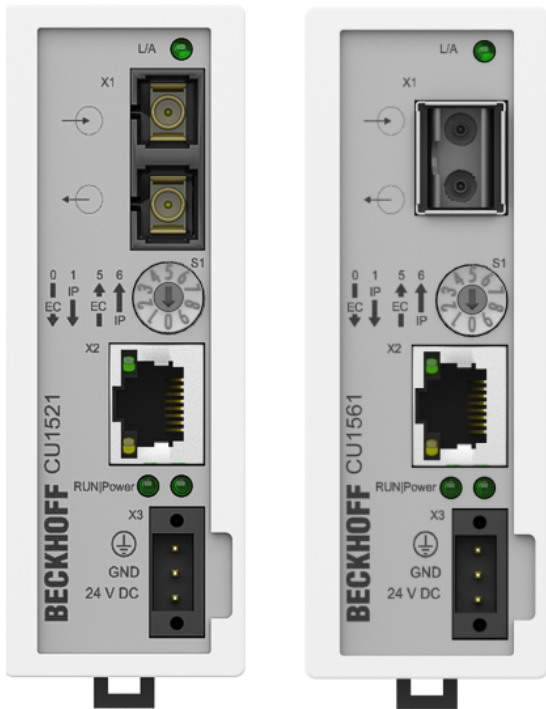

Fig. 6: Pin assignment CU1521, CU1521-0010, CU1561

LEDs for fieldbus diagnostics/power supply

LED	Color	Display	State	Description
L/A (X1) green (x2)	green	off	-	no connection on the EtherCAT strand
		on	linked	EtherCAT device connected
		flashing	active	Communication with EtherCAT device
Power	green	off		No supply voltage
		on		24 V supply voltage present

LED diagnostics EtherCAT State Machine

LED	Color	Meaning	
RUN	green	This LED indicates the terminal's operating state:	
		off	State of the EtherCAT State Machine: INIT = initialization of the terminal
		single flash	State of the EtherCAT State Machine: PREOP = function for mailbox communication and different standard-settings set
		flashing	State of the EtherCAT State Machine: SAFEOP = verification of the sync manager channels and the distributed clocks. Outputs remain in safe state
		on	State of the EtherCAT State Machine: OP = normal operating state; mailbox and process data communication is possible
	flickering	State of the EtherCAT State Machine: BOOTSTRAP = function for terminal firmware updates	
	orange	on	CU15x1 is in EtherCAT mode, rotary switch was moved during operation <i>Remedy:</i> Resetting or voltage reset
	red	on	CU15x1 is in Ethernet mode, rotary switch was moved during operation <i>Remedy:</i> Resetting or voltage reset
red/ green	flashing	Invalid rotary switch position after power-on <i>Remedy:</i> Move rotary switch to valid position	

2.2 CU1521-0020 (Infrastructure, media converter, 3-port junction, Ethernet/EtherCAT, 1000/100 Mbit/s, 24 V DC, SFP)

2.2.1 Introduction



Fig. 7: CU1521-0020

The CU1521-0020 is an infrastructure device with optional universal media converter function. Its two SFP slots can be equipped with various and also different SFP modules. It is primarily designed for use in EtherCAT networks, but also supports non-real-time critical Ethernet systems.

The use of EtherCAT is thus possible on the most different transmission paths and distances, depending on which transmission direction is selected and which SFP module is used. The media converter operates multidirectionally and collision-free with constant delay and represents a separate EtherCAT device. Thus, in contrast to standard media converters, the CU1521-0020 ensures fast link control even in the event of a fault, and thus safe termination of the EtherCAT strand and seamless continued operation of EtherCAT.

The EtherCAT transmission direction (RJ45 to SFP, SFP to RJ45, SFP to SFP) or the Ethernet operation can be configured at the device via a rotary switch.

The device is delivered without SFP, but with inserted SFP dust caps.

Quick links

- [EtherCAT basics](#)
- [Application notes \[▶ 29\]](#)
- [Diagnostic LEDs \[▶ 19\]](#)

2.2.2 Technical data

Technical data	CU1521-0020
Task within EtherCAT system	media transition from RJ45 copper physics to other (depending on SFP module) and back again
Data transfer medium	any (depending on SFP module); Ethernet/EtherCAT cable (min. Cat.5), shielded
Bus interface	1 x RJ45, SFP: depending on SFP module
Distance between stations	RJ45: max 100 m SFP: depending on SFP modul
Protocol	100 Mbit EtherCAT 10/100/1000 Mbit Ethernet
SFP-Interface X1/X2	1Gbit/s SFP interface according to Spec SFF INF-8074i, SGMII protocol, see note [▶ 31]! not downward compatible with 100Mbit/s SFP modules
Ethernet-Interface X3	10/100/1000 BASE-T, see note [▶ 31]!
Delay	approx. 1 µs per port
Data transfer rates	100 Mbit/s
Configuration	per rotary switch
Power supply	24 (18...30) V DC, 3-pin connection (+, -, PE)
Current consumption 24 V DC	approx. 120 mA
Dimensions (W x H x D)	34 mm x 98 mm x 77 mm
Weight	approx. 150 g
Montage [▶ 27]	on 35 mm mounting rail conforms to EN 60715
Operating temperature	-25°C ... +55°C
Storage temperature	-40°C ... +85°C
Relative humidity	95 %, no condensation
Vibration/shock resistance	conforms to EN 60068-2-6/EN 60068-2-27
EMC immunity/emission	conforms to EN 61000-6-2/EN 61000-6-4
Protect. rating/installation pos.	IP20/variable
Relative humidity	95 %, no condensation
Marking/Approvals ^{*)}	CE, UKCA

*) Real applicable approvals/markings see type plate on the side (product marking).

2.2.3 Diagnostic LEDs

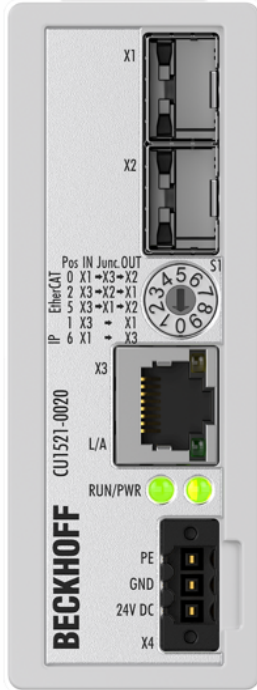

Fig. 8: CU1521-0020 (front view)

LEDs for fieldbus diagnostics/power supply

LED	Color	Display	State	Description
L/A (X3)	green	off	-	no connection on the EtherCAT strand
		on	linked	EtherCAT device connected
		flashing	active	Communication with EtherCAT device
Power	green	off		No supply voltage
		on		24 V supply voltage present

LED diagnostics EtherCAT State Machine

LED	Color	Meaning	
RUN	green	This LED indicates the terminal's operating state:	
		off	State of the EtherCAT State Machine: INIT = initialization of the terminal
		single flash	State of the EtherCAT State Machine: PREOP = function for mailbox communication and different standard-settings set
		flashing	State of the EtherCAT State Machine: SAFEOP = verification of the sync manager channels and the distributed clocks. Outputs remain in safe state
		on	State of the EtherCAT State Machine: OP = normal operating state; mailbox and process data communication is possible
	flickering	State of the EtherCAT State Machine: BOOTSTRAP = function for terminal firmware updates	
	orange	on	CU15x1 is in EtherCAT mode, rotary switch was moved during operation <i>Remedy:</i> Resetting or voltage reset
	red	on	CU15x1 is in Ethernet mode, rotary switch was moved during operation <i>Remedy:</i> Resetting or voltage reset
red/ green	flashing	Invalid rotary switch position after power-on <i>Remedy:</i> Move rotary switch to valid position	

3 Basic principles

3.1 EtherCAT basics

Please refer to the [EtherCAT System Documentation](#) for the EtherCAT fieldbus basics.

3.2 EtherCAT cabling – wire-bound

The cable length between two EtherCAT devices must not exceed 100 m. This results from the FastEthernet technology, which, above all for reasons of signal attenuation over the length of the cable, allows a maximum link length of 5 + 90 + 5 m if cables with appropriate properties are used. See also the [Design recommendations for the infrastructure for EtherCAT/Ethernet](#).

Cables and connectors

For connecting EtherCAT devices only Ethernet connections (cables + plugs) that meet the requirements of at least category 5 (Cat5) according to EN 50173 or ISO/IEC 11801 should be used. EtherCAT uses 4 wires for signal transfer.

EtherCAT uses RJ45 plug connectors, for example. The pin assignment is compatible with the Ethernet standard (ISO/IEC 8802-3).

Pin	Color of conductor	Signal	Description
1	yellow	TD +	Transmission Data +
2	orange	TD -	Transmission Data -
3	white	RD +	Receiver Data +
6	blue	RD -	Receiver Data -

Due to automatic cable detection (auto-crossing) symmetric (1:1) or cross-over cables can be used between EtherCAT devices from Beckhoff.

● Recommended cables

- i** It is recommended to use the appropriate Beckhoff components e.g.
- cable sets ZK1090-9191-xxxx respectively
 - RJ45 connector, field assembly ZS1090-0005
 - EtherCAT cable, field assembly ZB9010, ZB9020

Suitable cables for the connection of EtherCAT devices can be found on the [Beckhoff website!](#)

E-Bus supply

A bus coupler can supply the EL terminals added to it with the E-bus system voltage of 5 V; a coupler is thereby loadable up to 2 A as a rule (see details in respective device documentation). Information on how much current each EL terminal requires from the E-bus supply is available online and in the catalogue. If the added terminals require more current than the coupler can supply, then power feed terminals (e.g. [EL9410](#)) must be inserted at appropriate places in the terminal strand.

The pre-calculated theoretical maximum E-Bus current is displayed in the TwinCAT System Manager. A shortfall is marked by a negative total amount and an exclamation mark; a power feed terminal is to be placed before such a position.

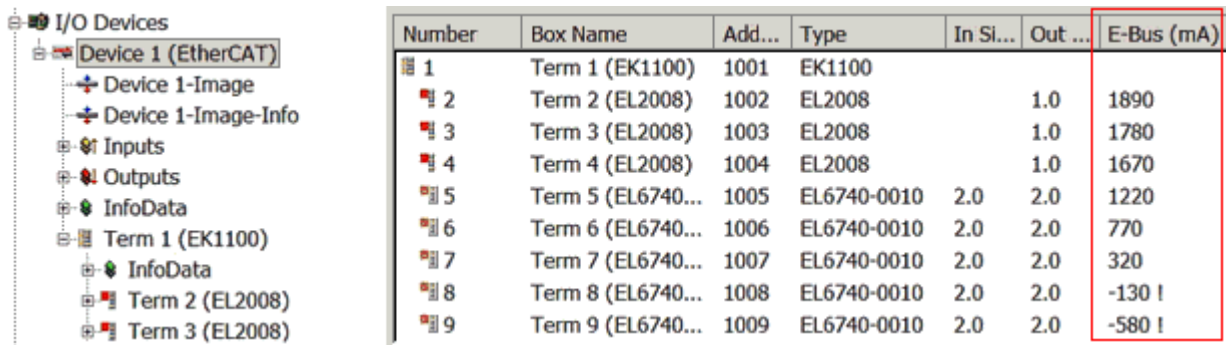

Fig. 9: System manager current calculation

NOTICE

Malfunction possible!
 The same ground potential must be used for the E-Bus supply of all EtherCAT terminals in a terminal block!

3.3 EtherCAT State Machine

The state of the EtherCAT slave is controlled via the EtherCAT State Machine (ESM). Depending upon the state, different functions are accessible or executable in the EtherCAT slave. Specific commands must be sent by the EtherCAT master to the device in each state, particularly during the bootup of the slave.

A distinction is made between the following states:

- Init
- Pre-Operational
- Safe-Operational and
- Operational
- Boot

The regular state of each EtherCAT slave after bootup is the OP state.

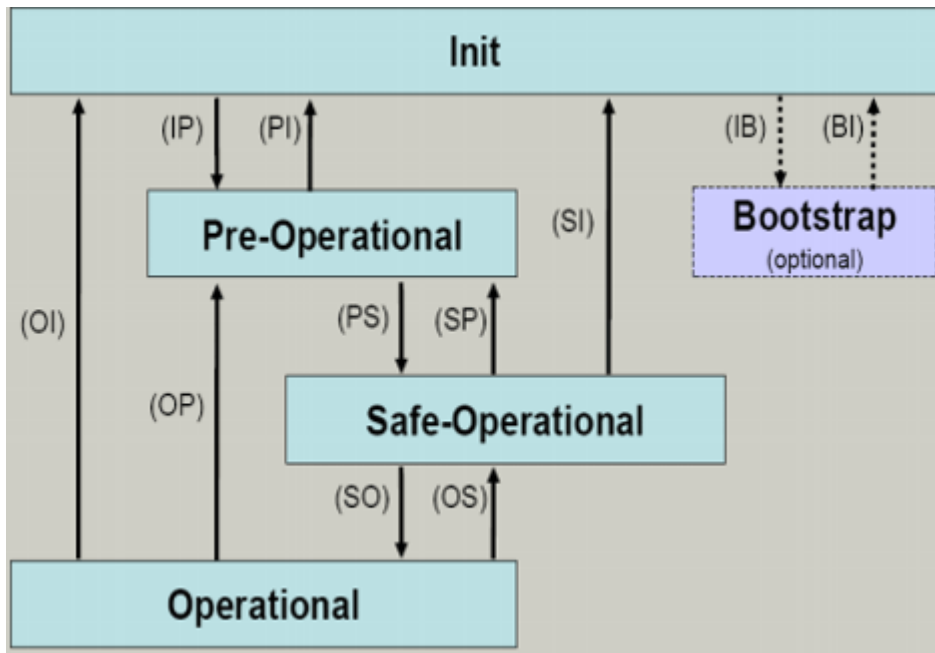

Fig. 10: States of the EtherCAT State Machine

Init

After switch-on the EtherCAT slave in the *Init* state. No mailbox or process data communication is possible. The EtherCAT master initializes sync manager channels 0 and 1 for mailbox communication.

Pre-Operational (Pre-Op)

During the transition between *Init* and *Pre-Op* the EtherCAT slave checks whether the mailbox was initialized correctly.

In *Pre-Op* state mailbox communication is possible, but not process data communication. The EtherCAT master initializes the sync manager channels for process data (from sync manager channel 2), the FMMU channels and, if the slave supports configurable mapping, PDO mapping or the sync manager PDO assignment. In this state the settings for the process data transfer and perhaps terminal-specific parameters that may differ from the default settings are also transferred.

Safe-Operational (Safe-Op)

During transition between *Pre-Op* and *Safe-Op* the EtherCAT slave checks whether the sync manager channels for process data communication and, if required, the distributed clocks settings are correct. Before it acknowledges the change of state, the EtherCAT slave copies current input data into the associated DP-RAM areas of the EtherCAT slave controller (ECSC).

In *Safe-Op* state mailbox and process data communication is possible, although the slave keeps its outputs in a safe state, while the input data are updated cyclically.

Outputs in SAFEOP state

The default set watchdog monitoring sets the outputs of the module in a safe state - depending on the settings in SAFEOP and OP - e.g. in OFF state. If this is prevented by deactivation of the watchdog monitoring in the module, the outputs can be switched or set also in the SAFEOP state.

Operational (Op)

Before the EtherCAT master switches the EtherCAT slave from *Safe-Op* to *Op* it must transfer valid output data.

In the *Op* state the slave copies the output data of the masters to its outputs. Process data and mailbox communication is possible.

Boot

In the *Boot* state the slave firmware can be updated. The *Boot* state can only be reached via the *Init* state.

In the *Boot* state mailbox communication via the *file access over EtherCAT* (FoE) protocol is possible, but no other mailbox communication and no process data communication.

4 Mounting and wiring

4.1 Dimensions

i **Space requirement in the control cabinet**

- The RJ45 connector increase the depth depending on their design and the Ethernet cable used.
- Above the mounting rail an additional height of approx. 10 mm is required to enable latching [▶ 27] of the switch onto the rail.

CU1521-00x0

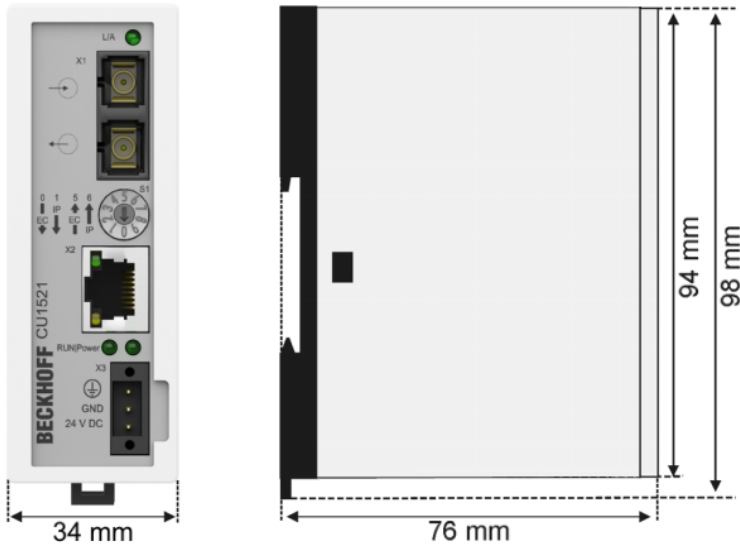

Fig. 11: CU1521-00x0

CU1561

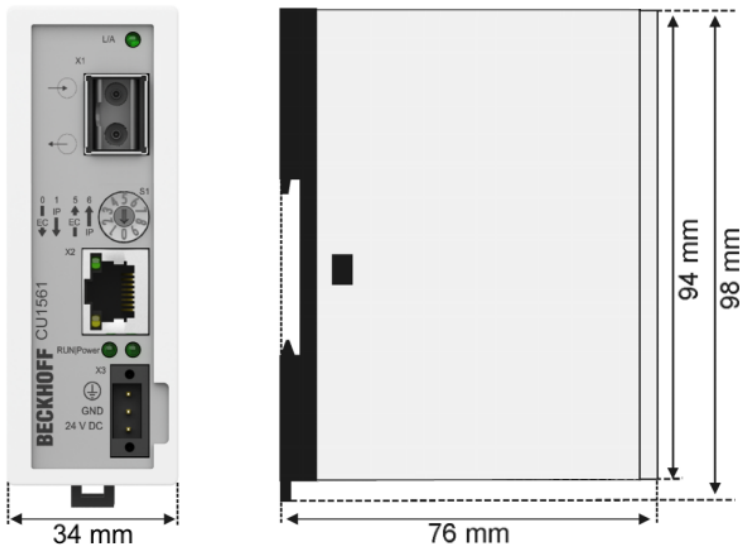

Fig. 12: CU1561

4.2 Mounting and demounting

The CU15xx converters are mounted on the mounting surface with the aid of a 35 mm DIN rail (according to EN 60715).

i Mounting rail installation

Please ensure that the CU15x1 engages properly on the mounting rail.

Mounting

- Fit the mounting rail to the planned assembly location.
- Position the device in the mounting rail with the spring at the top of its latching flange (1)
- Push the lower side of the device (2) against the mounting surface until it latches on the mounting rail.
- Attach the cable.

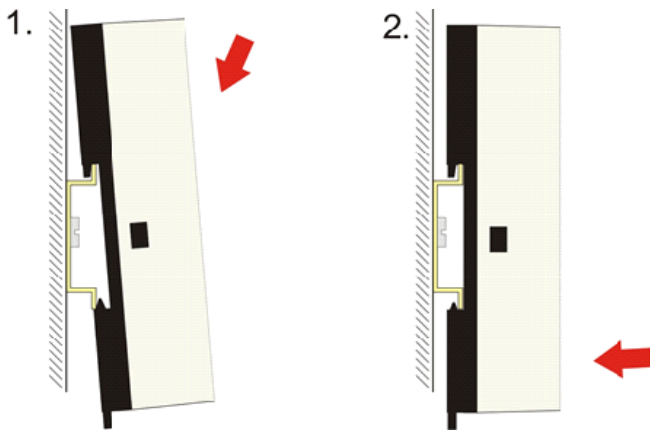

Fig. 13: Mounting

Removal

- Remove all the cables.
- Pull the strap on the underside of the device (1) downwards with a screwdriver
- Pull the device upwards away from the mounting surface (2)

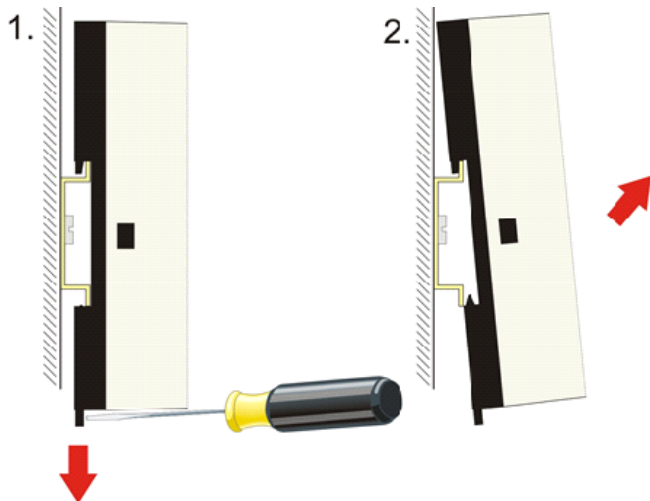

Fig. 14: Removal

4.3 UL notice

⚠ CAUTION



Application

Beckhoff EtherCAT modules are intended for use with Beckhoff's UL Listed EtherCAT System only.

⚠ CAUTION



Examination

For cULus examination, the Beckhoff I/O System has only been investigated for risk of fire and electrical shock (in accordance with UL508 and CSA C22.2 No. 142).

⚠ CAUTION



For devices with Ethernet connectors

Not for connection to telecommunication circuits.

Basic principles

UL certification according to UL508. Devices with this kind of certification are marked by this sign:



5 Commissioning/application notes

5.1 Application notes

The media converters CU1521, CU1521-0010, CU1561 (referred to as CU15x1 below) physically convert 100 Mbit telegrams (Fast Ethernet) from copper physics (RJ45 connector) to optical fiber (SC connector or versatile link) and back.

The CU1521-0020 can be equipped with SFP/SFP+ modules, so that the conversion of copper physics (RJ45 connector) to various of transmission paths is possible, depending on the SFP module used.

NOTICE

Permitted SFP modules

Only SFP modules qualified by Beckhoff (not included in the scope of delivery) are to be used, see [Technical data \[► 21\]!](#)

Special behavior is expected from the converter, depending on whether EtherCAT or standard Ethernet telegrams are to be transferred.

Used for: Standard Ethernet 10/100 Mbit

An Ethernet connection is a managed point-to-point connection between two intelligent end devices.

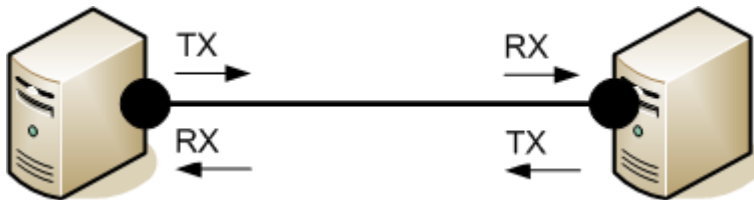

Fig. 15: Point-to-point connection between two Ethernet devices

Both devices send a so-called idle sample to their Ethernet connection. The *link* has been established if a corresponding sample is received. Both devices then know that they can use this connection. If the connection is interrupted, the link is lost and both devices are notified.

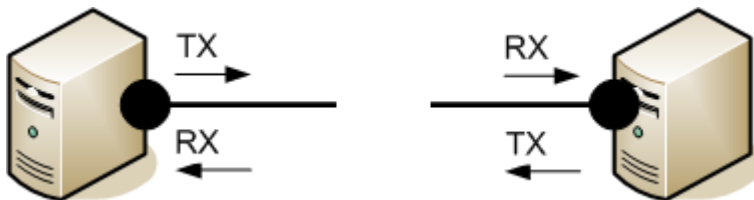

Fig. 16: Interrupted point-to-point connection

If a media converter is placed between the two stations, it too becomes an intelligent transmitter/receiver. If connection C is interrupted, device A would not necessarily be informed and would continue to send data to the converter via the existing link B, and the data would "trickle away". The CU15x1 therefore supports *Link Loss Forwarding* (LLF) in a selected direction. The notification is indicated by a label on the CU15x1. If the converter detects an interruption of connection C in switch setting 1 in Fig. *Interposed media converter in the Ethernet connection*, it also interrupts link B.

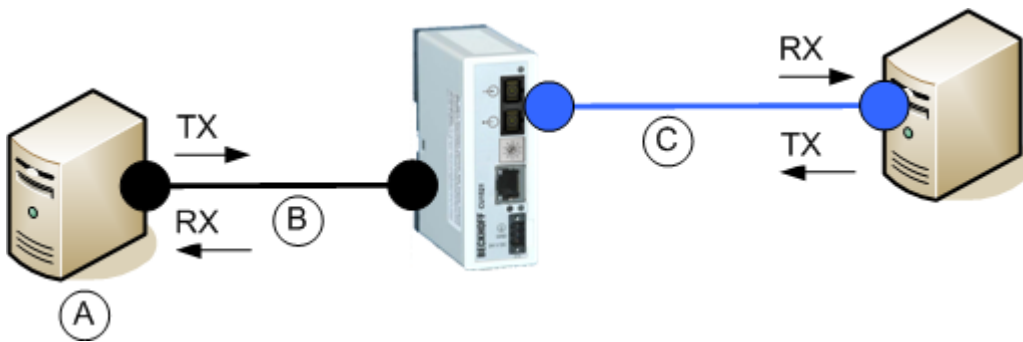

Fig. 17: Interposed media converter in the Ethernet connection

In both IP settings the CU15x1 operates as a store and forward network device with checksum function. Frames that are faulty (CRC error), too short (< 64 bytes) or too long (> 1522 bytes) are not passed on.

Used for: EtherCAT 100 Mbit

Other characteristics are required if it is used as a media converter in an EtherCAT network:

- Consistently low delay in the frame transit, irrespective of frame length
- Fast link detection when the connection is established and interrupted
- Identification as separate EtherCAT device with diagnostic function

EtherCAT slaves process the EtherCAT telegrams in forward direction from the perspective of the master. Accordingly, in the CU15x1 the forward direction may be X1 --> X2 or X2 --> X1, depending on the application. It has to be set at the rotary switch prior to commissioning. The direction of the arrow of S1 indicates the set forward direction.

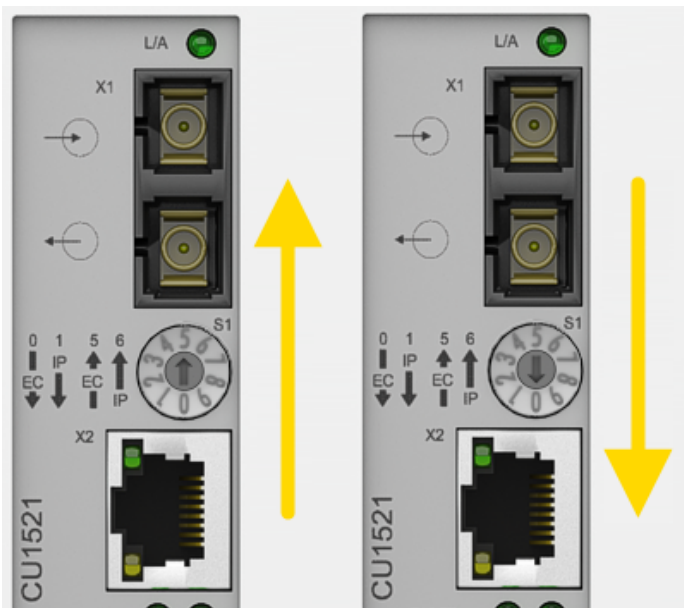

Fig. 18: Setting the forward direction at the media converter

Make sure the rotary switch is set to the right position, so that the CU15x1 operates in forward direction. For example, in Fig. *Copper -> optical fiber-> copper operation of two media converters*, the CU15x1 on the left operates as a copper --> optical fiber converter (rotary switch position 5), the CU15x1 on the right operates as an optical fiber --> copper converter (rotary switch position 0).

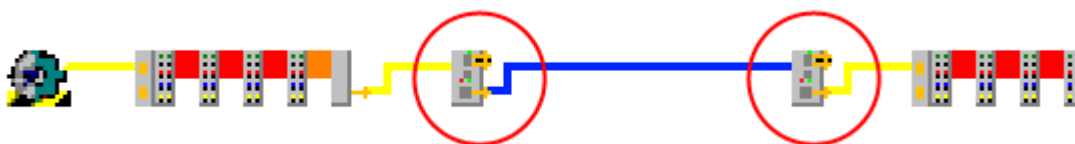

Fig. 19: Copper -> optical fiber-> copper operation of two media converters

If the opposite direction of rotation is set, the subsequent behavior depends on the EtherCAT master. The scanned CU15x1 may be inserted at a different position in the topology, or an INIT_VPRS error message of the EtherCAT master may occur.

● Frame size in Ethernet mode



In Ethernet mode only a frame size from 64 to 1522 bytes is supported.

Operating and application notes for SFP modules with the CU1521-0020

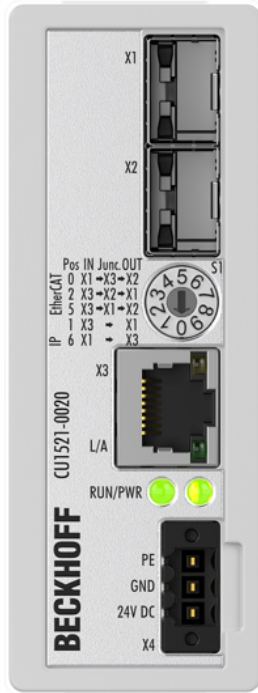

Fig. 20: CU1521-0020, rotary switch positions and ports

EtherCAT mode

- All 3 ports X1, X2, X3 are in operation in the order designated by rotary switch
- The CU1521-0020 can be used as a 2-port media converter or as a 3-port branch with media converter function
- The ports X1/X2 can be equipped with different SFP, at least one is necessary (see following SFP note)
- 100Mbit EtherCAT is supported (as of 2023), Gbit EtherCAT is in preparation (nevertheless 1Gbit-SFP are needed!)
- Only SFP modules approved by Beckhoff should be used to ensure EtherCAT suitability

Ethernet mode

- The 2 ports X1 and X3 are in operation - the device works as a media converter
- Different speeds (10Mbit, 100Mbit, 1Gbit) can be applied to port X1 and X3.
- The device works in store-and-forward principle
- Port X1 must be equipped with a SFP (see following SFP note)
- The device supports "Link Loss Forwarding"

Application notes for SFP modules

The SFP is not sold by Beckhoff as an accessory and is not part of the scope of delivery.

A functional guarantee and compatibility with all SFPs available worldwide cannot be given by Beckhoff. When procuring the SFP individually, the following points must be observed

- the suitable operating temperature range of the SFP
- no use of 100 Mbit modules, only 1Gbit SFPs are permitted
- no SFP+ modules (SFP+ means >1Gbit)

In EtherCAT operation, the SFP used must not impair operation (line control, timing).

The following types have been qualified by Beckhoff (as of 2023):

- Cisco GLC-BX40-D-I and GLC-BX40-U-I, bidirectional optical fiber, LC/PC, 40km, 1550/1310nm.
- FS 36888 and 36889, Bidirectional optical fiber, LC/PC, 40km, 1550/1310nm

Earthing/Shielding

The FE contact on the supply socket must be directly connected to the mounting rail contact. During assembly, always take care of a conductive connection to the mounting rail.

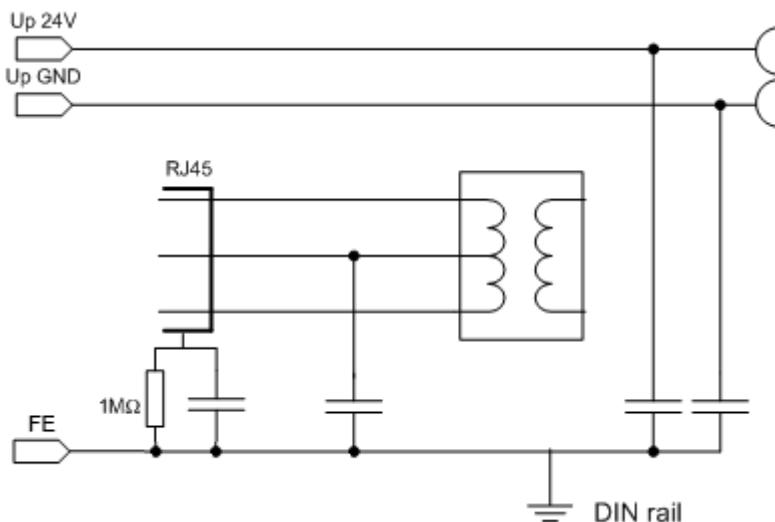

Fig. 21: Internal earthing concept

Firmware update

A firmware update via EtherCAT is not possible for devices of the CU15x1 series

General notes

The CU15x1 deals with setting the rotary switch when the supply voltage is applied, unless the rotary switch is in an invalid position. In this case the CU15x1 deals with the setting when the rotary switch reaches a valid position for the first time.

If the rotary switch is moved during valid operation, the CU15x1 does not alter its function but indicates this state through its LED, see [Diagnostics](#) [► 19]. The switch setting must be rectified before the voltage is re-applied!

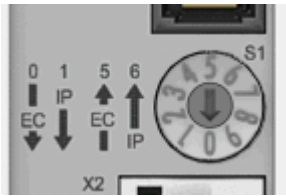

Fig. 22: Rotary switch

Slanting installation of the optical fiber socket in the CU15x1 reduces the bending radius of the optical fiber cable during connection in the control cabinet (Fig. *Slanting installation of the optical fiber socket*).



Fig. 23: Slanting installation of the optical fiber socket

5.2 Notes on converters with RJ45 fiber-optic connection



Fig. 24: CU1521

Mounting rail installation



Mounting

Please ensure that the CU15x1 engages properly on the mounting rail. See chapter [Mounting rail installation](#) [[▶ 27](#)].

5.2.1 Principles of fiber-optic technology

When using fiber-optic cables for the transmission of data, there are various factors that influence the signal transmission and have to be observed in order to guarantee reliable transmission. Important principles of fiber-optic technology are described below.

Attenuation

Less light reaches the end of a connection with fiber-optic cables than is input at the start of the connection. This loss of light between the start and end of the transmission link is called attenuation. The attenuation between two points is often stated in decibels (dB). However, the decibel is not a unit, but a ratio – in the case of a fiber-optic cable it is the ratio of the light energy at the start of the connection to that at the end. It is one tenth of a Bel (B) (1 B = 10 dB). In general, decibel indicates a power level L_p from the ratio of one power P_1 to another power P_2 .

- $L_p[\text{dB}] = 10 \cdot \log_{10}(P_1/P_2)$

A positive power factor is a signal amplification, a negative power factor conversely a weakening or attenuation of the signal.

The attenuation of a fiber-optic connection is essentially determined by three influencing factors. These influencing factors are the attenuation in the fiber-optic, the attenuation in the connector and the attenuations that result from the splices in the fiber-optic connection. The total attenuation is therefore given by

- Fiber-optic link attenuation [dB] = fiber loss attenuation [dB] + connector insertion attenuation [dB] + splice insertion attenuation [dB]

Where

- fiber loss attenuation [dB] = fiber attenuation coefficient [dB/km] x length [km]
- connector insertion attenuation [dB] = number of connectors x connector insertion attenuation [dB]
- splice insertion attenuation [dB] = number of splices x splice insertion attenuation [dB]

Dispersion

A further influence that needs to be observed with the signal transmission is the dispersion. Dispersion describes the spreading or widening of a light pulse. Due to propagation differences resulting in the fiber-optic cable from different injection angles of the light waves, the optical pulse widens and is therefore wider at the output than at the input. The longer the transmission link, the greater the dispersion.

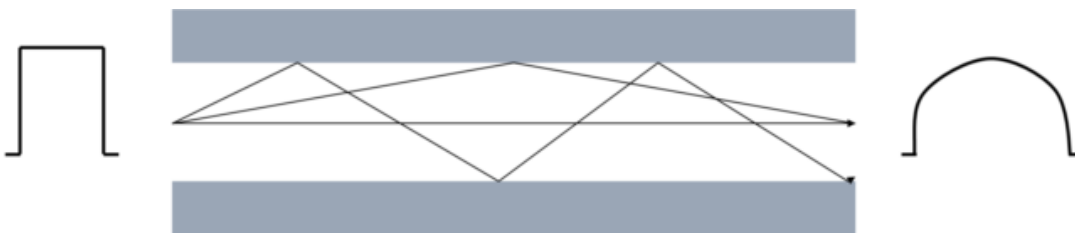

Fig. 25: Dispersion

If higher data rates are to be transmitted by the fiber-optic cable, the pulses must be sent faster at the input. What may happen then, however, is that pulses at the output run into one another and can no longer be distinguished from one another. The dispersion thus limits the maximum bandwidth of the fiber-optic connection.

The maximum bandwidth is specified in the data sheet for a fiber-optic cable as the bandwidth/length ratio in the unit MHz*km. Therefore, the longer a transmission link, the smaller the available bandwidth. The bandwidth/length ratio or product is always specified in the data sheet for a fiber-optic cable. The length of the transmission link can then be calculated with the necessary bandwidth.

$$s [\text{km}] = \text{bandwidth} [\text{MHz}] / \text{bandwidth/length ratio} [\text{MHz/km}]$$

Further influences on the signal transmission

In addition to the main influences (attenuation and dispersion) that limit the transmission link, care must be taken when installing and maintaining fiber-optic transmission links.

Sharp kinks and micro-bends in the fiber-optic lead to additional reflections in the fiber, as a result of which the influences of the attenuation and dispersion are increased. The specified bending radii of fiber-optic cables must be adhered to.

Poorly installed connectors also have a great influence on the signal quality. In case of poor connections, the fiber-optic may be too far away from the connecting piece, so that the light waves do not enter the fiber at the right angle of entry.

The third influence on the signal transmission that needs to be observed is soiling of, or damage to the ends of optical fibers. Due to the size of the fibers, often just 125 µm, dirt or damage cannot be discerned with the naked eye. Only a microscope with a sufficient magnification (at least factor 100) enables the fiber ends to be checked. To prevent soiling, the cable cap supplied with the cable should always be fitted to the fiber end.

Power and attenuation budget

The power budget specifies the minimum power present between transmitter and receiver. The attenuation budget, conversely, describes the attenuation present between transmitter and receiver due to the three attenuation influences - fiber, connectors and splices - described above.

Transceivers (from the words transmitter and receiver) are installed in fiber-optic transmitters and/or receivers. This transceiver is a combined transmitting and receiving device. The data sheet for the transceiver contains two values that are necessary for the calculation of the power budget. These values are the **minimum output power** of the transmitter and the **maximum sensitivity** of the receiver. Therefore, the worst case, i.e. the lowest power between transmitter and receiver, is always considered. Both values are often specified in the unit decibel milliwatt (dBm). dBm describes a power level in relation to a reference value of 1 mW.

- $L_p[\text{dB}] = 10 \cdot \log_{10}(P_1/1 \text{ mW})$

0 dBm then corresponds to a power value of 1 mW, positive dBm values indicate power values >1 mW and negative dBm values indicate power values <1 mW.

The difference between the maximum output power and the minimum sensitivity at the input results in the power level.

- Power level = minimum output power - maximum sensitivity

The attenuation level results from the influences on the attenuation described above.

- Attenuation level [dB] = fiber loss attenuation [dB] + connector insertion attenuation [dB] + splice insertion attenuation [dB]

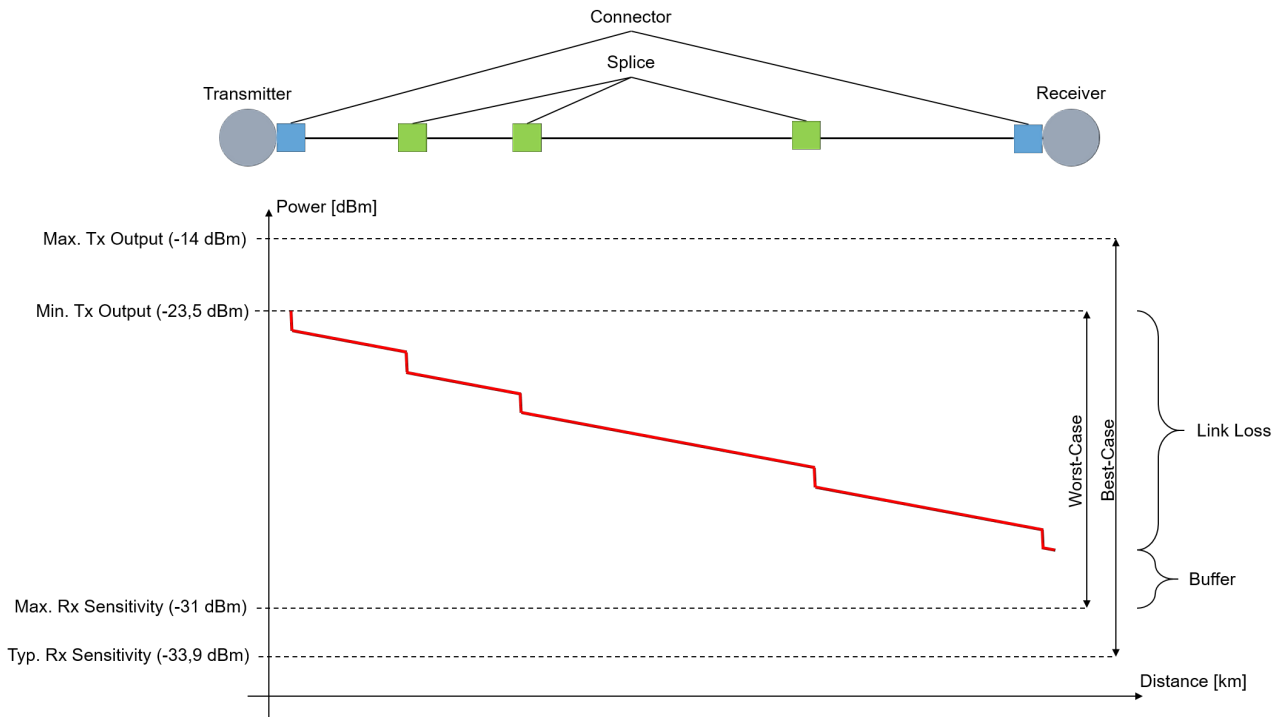

Fig. 26: Power and attenuation budget

The attenuation level must not exceed the power level. A power buffer of >3 dB is recommended so that long-term operation is possible over many years despite power losses. Sources located in the transmitter can age and lose power, connectors or splices can deteriorate, or connectors can become dirty if they are opened for diverting or testing. If cables are inadvertently cut through, excess play is required in order to accommodate splices for reconnecting.

Example calculation of power and attenuation budget

In an example calculation, the power and attenuation budget is to be calculated for a transmission link of 2.1 km in length between an EK1501 and an EK1521 with a multimode fiber in the strength 50/125 μm. The two fiber-optic couplers under consideration have the same transceiver. The optical data are given in the technical data for the EK1521.

First of all, the power budget existing between the two couplers must be calculated:

Power budget	
Parameter	Value
Minimum output power [50/125 μm]	-23.5 dBm
Maximum sensitivity	-31 dBm
Power budget	7.5 dBm

In the next step, the attenuation budget, i.e. the attenuation over the entire transmission link, must be calculated. A multimode fiber in the strength 50/125 μm from Beckhoff (ZK1091-1001-xxxx) is used for this example. A maximum attenuation of 0.8 dB/km at a wavelength of 1300 nm is specified in the data sheet for the fiber-optic cable. The cable is connected at both ends via an SC connector. The typical attenuation value of SC connectors is 0.25 dB, but it should nevertheless be checked for the specific application. Three splices were made over the entire link. A typical attenuation of 0.3 dB can be assumed per splice connection; however, the attenuation of a splice is dependent on its quality. The attenuation budget must be calculated from these values in the following.

Attenuation budget		
Parameter	Number	Value
Fiber loss attenuation (0.8 dB/km)	2.1 km	1.68 dB
Connector insertion attenuation (0.25 dB)	2	0.5 dB
Splice insertion attenuation (0.3 dB)	3	0.9 dB
Attenuation budget		3.08 dB

If the attenuation budget is now subtracted from the power budget, a power buffer of 4.42 dB results. This is greater than 3 dB and is therefore sufficient as a buffer for most applications, so that an additional splice or slight soiling of the fiber would not lead to failure of the data transmission.

If several values are given for a parameter in the data sheet for transceivers, cables or connectors, the worst value should always be taken and used for the calculation.

For the transmission link under consideration, the bandwidth/length ratio specified in the data sheet for the fiber should always be considered in addition to the attenuation and, as shown above, one should calculate whether the implementation of the length of the transmission link is possible with the desired bandwidth and the fiber.

Evaluation of a fiber-optic transmission link by means of measurement

A fiber-optic transmission link can be described and evaluated with parameters from data sheets. In order to obtain a real result for the attenuation over the entire link, however, the link must be measured using an optical power meter (OPM). The power at the end of the transmission link can be measured with an OPM.

When measuring with an OPM, it is essential to ensure that only the required adapter (FC, SC, ...) is screwed to the OPM. If several adapters are screwed above one another to the OPM, the distance between the connector and the detector in the OPM is too large, with the result that lower power values are displayed (greater attenuation than actually exists).



OPM without adapter



OPM with FC adapter screwed on



OPM with SC adapter screwed on



OPM with FC and SC adapter screwed on - WRONG

5.2.2 Notes on suitable optical fiber cables

General information on optical fiber types

Optical fiber are available as multimode and single mode types with different step and graded indices.

Step and graded index

Optical fiber cables consist of 2 concentric materials, the core and cladding, plus a protective (colored) jacket. The core and the cladding have a different index of refraction, causing the light waves (modes; a mode is a natural wave in the optical fiber) to be reflected back into the core at the boundary. Due to the step change in the index of refraction this type of fiber is referred to as step index. A gradual/parabolic transition between the index of refraction in the core and the coating (referred to as graded index) can be achieved by mixing the materials. In a graded index fiber the modes are gradually diffracted back to the core, leading to propagation-time compensation and significantly higher quality of the light pulse at the outlet compared with a multimode step index fiber, where the different light modes have different signal run times (mode dispersion) with associated front distortion.

Single mode

Single-mode fibers have a very thin core (9 μm) and therefore conduct only a single mode of the light used, with high signal quality and virtually without mode dispersion. They are only available as step index fibers. Due to the high signal quality they are suitable for large transmission bandwidths $> 10 \text{ GHz}\cdot\text{km}$ and distances $> 50 \text{ km}$. The refractive index profile of single-mode fibers is dimensioned such that the multipath propagation (intermodal dispersion), which is a problem with multi-mode fibers, is omitted – the signal light propagates in a single-mode fiber only in a single guided fiber mode, hence the designation 'single-mode'. This makes considerably larger transmission distances and/or bandwidths possible, and the limiting effect that arises next is the color distortion of the transmitted mode.

Multimode

Multimode fiber-optics are manufactured as step index or graded index. Step index multimode fiber cables are suitable for transmission bandwidths up to $100 \text{ MHz}\cdot\text{km}$ and distances up to 1 km. Graded index multimode fiber cables with core diameters between 50 and 62.5 μm reach transmission bandwidths $> 1 \text{ GHz}\cdot\text{km}$ and ranges $> 10 \text{ km}$. Multimode means that the core of the fiber-optic cable is thick enough to enable several light modes to propagate reflectively in the cable.

There are different types of multimode fiber-optics, which are optimized for different wavelengths or transmission sources. Through the optimization of the fibers for different wavelengths, the attenuation differs with different transmission rates and the bandwidth/length ratio differs for the different fiber types. The exact values must be taken from the data sheet for the selected fiber in order to check whether the use of the selected fiber is wise.

- OM1: 62.5/125 μm , optimized for 1300 nm LEDs
- OM2: 50/125 μm , optimized for 1300 nm LEDs
- OM3: 50/125 μm , optimized for 850 nm VCSEL (vertical-cavity surface-emitting laser)
- OM4: 50/125 μm , optimized for 850 nm VCSEL (vertical-cavity surface-emitting laser)

5.2.3 Application with CU1521 and CU1521-0010

Application with CU1521 and CU1521-0010

The CU1521, CU1521-0010 are intended for application with optical fiber cables with the following characteristics:

- SC duplex connector.
- CU1521: Duplex multimode 50/125 μm or 62.5/125 μm (inner/outer core diameter). The use of both diameters is possible. However, the use of 50/125 μm is recommended due to the lower attenuation.
- CU1521-0010: Duplex single-mode 9/125 μm (inner/outer core diameter). A typically usable cable can be manufactured according to the specification ITU-T G.652.D (0.4.4dBm/km at 1300 nm).

● Recommended connectors

i The use of SC/PC connectors is recommended for connecting to the CU1521, CU1521-0010. The advantage of the "PC" (physical contact) version of this connector is the crowned end face, which allows the region of the fiber core that is relevant to transmission to be optimally joined when the connector is pushed together. Other versions include, for instance, the SC/**UPC** (ultra-polish PC), SC/**HRL** (high return loss) and the SC/**APC** plug (angled physical contact). An additional feature of these connectors is that light that is reflected by the connector's end face, which is at an angle of about 8° to the fiber axis, is refracted from the core by the cladding glass into the air. This avoids interference with the data transmission, optimizing the core size of the back-scatter.

● 50/125 μm or 62.5/125 μm

i The use of both diameters is possible. However, the use of 50/125 μm is recommended due to the lower attenuation.

In optical fibers the wavelengths 850 nm and 1300 nm are usually used for data transfer. Commercially available optical fiber cables are usually optimized for application in one of these ranges, since signal attenuation is frequency-dependent (like in copper cable), so that large ranges of several km can be achieved for the respective wavelength. In general, optical fiber cables exhibit a lower attenuation at a wavelength of 1300 nm than at 850 nm.

In the CU1521, CU1521-0010 a transceiver with the wavelength of 1300 nm is used.

● Range and bandwidth product

i Optical fiber cables are available in different qualities from reputable manufacturers. One of the relevant parameters for the user is the frequency-dependent bandwidth product of a cable, specified in [MHz*km]. The greater the bandwidth product, the lower the attenuation, and therefore the larger the range that can be achieved with this cable (see ITU-T G-651). To maximize the range with the CU1521, CU1521-0010 optical fiber cables with a maximum high bandwidth product at 1300 nm should therefore be used. We recommend optical fiber cables from the OM2 class (EN50173:2002).

Standard optical fiber cables have a minimum bandwidth product of 500 MHz*km at 1300 nm, higher-quality cables are suitable for distances > 500 m over > 1000 MHz*km.

For maximum distances the remote counterpart of the CU1521, CU1521-0010 should also support such ranges.

● Installation notes

i The following parameters must be taken into account in the installation of optical fiber cables

- permitted bending radius
- permitted tensile strength
- sensitivity of the exposed contact ends

Further information can be found in the following documents:

- ITU recommendation ITU-T G.651 - G.655
- EN 50173:2002
- EN 60793-2

5.2.4 Connecting and disconnecting the fiber cable

Connecting and disconnecting the optical fiber cable

NOTICE

Risk of damage to the cable!

To disconnect the optical fiber cable always pull the connector to release the locking mechanism - never pull the optical fiber cable itself.

● Crossover cables

i Please note that when connecting the CU1521, CU1521-0010 to the remote station, it may be necessary to use "crossed" cables in order to establish a connection.

Practical tip:

The infrared light emission can be made visible with some digital/mobile phone cameras (see figure *Visualization of infrared light at the SC Duplex connector*), whether the camera used can receive the IR wavelengths; must be checked in each individual case. Avoid 'light meeting light' when connecting the optical fiber cable (Tx -> Tx). In this case no connection can be established, and you have to cross the cables (Tx -> Rx).



Fig. 27: Visualization of infrared light at the SC duplex connector

● Use of blind plugs

i To protect the transceiver from environmental influences, unused connection socket should be sealed with the blind plugs provided! See Fig.: *Blind plugs in unused sockets*



Fig. 28: Blind plugs in unused sockets

5.3 Notes on converters with RJ45 POF connection

5.3.1 Notes regarding suitable POF cables

General information about POF cables

The standard polymer fiber is 1 mm thick and consists of a 0.98 mm thick core made of polymethyl methacrylate (PMMA) as well as a thin sheath. In order to enable the guidance of light using the effect of total reflection in the core, the usually very thin sheath consists of fluorinated PMMA, which has a low refractive index. The core diameters lie between 0.06 mm and 1 mm, as a result of which simple plug connections are easy to implement. Furthermore, the splicing process often used for the connection of glass fibers and the unnecessarily high expenditure associated with it can usually be dispensed with. The maximum operating temperature of standard POF is approximately 60°C and has a refraction profile with step index (SI-POF). The refractive index of the core material is around 1.49 and that of the sheath around 1.41. The difference determines the numerical aperture (NA) and thus the maximum propagation angle. With a difference of 5% this angle is about 20 degrees in relation to the fiber axis, which leads to a reduction in the bandwidth.

Due to the simple and almost universally applicable connection techniques compared to glass fibers, POFs are used in particular for short transmission distances, such as inside rooms, technical equipment, mechanical systems or cars.

POFs have an attenuation of about 140 dB/km at a wavelength of 650 Nm, so that a maximum data transmission distance of 50 m can be achieved when used with the CU1561.

Insertion of additional connectors in the route increases the signal attenuation. For each additional connector, the maximum permitted distances typically reduces by 6.5 m.

Application with CU1561

● Recommended plug connectors and POF cables

i For the connection of the CU1561 it is recommended to use the connector set [ZS1090-0008 \[► 47\]](#) (Versatile Link Duplex plugs) in conjunction with a duplex polymer fiber with an outside diameter of 2 x 2.2 mm (Z1190), which are available from Beckhoff.

● Installation notes

i Among other things, the following items should be observed when laying POF cables:

- permissible bending radius (in general $r \geq 25$ mm, refer to the manufacturer's data!)
- permitted tensile strength
- sensitivity of the exposed contact ends

5.3.2 Connecting and disconnecting the POF cable

To connect the cable, insert the plug (available as an accessory in the connector set ZS1090-0008) into the connection opening until it audibly latches.

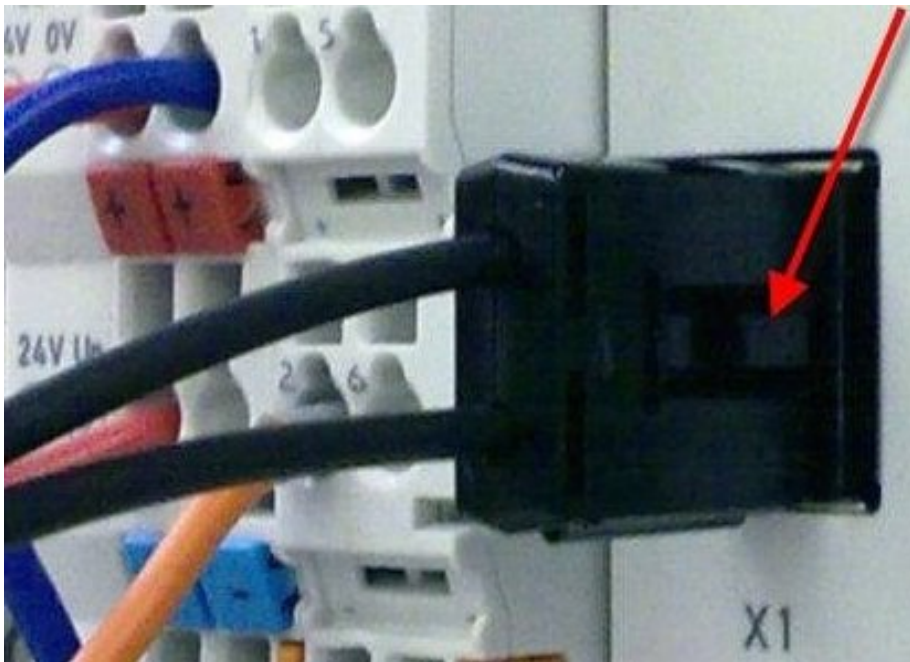

Fig. 29: Latching lug with release catch on the POF duplex plug

To release the connector activate the release device with the latching lug. This is located on the right-hand side of the connector (see Fig. *Latching lug with release catch on the POF duplex plug*)

NOTICE

Risk of damage to the cable!

To release the cable, press the release catch on the plug and pull the plug at the same time – never pull by the POF cable alone!

NOTICE

TX / Rx channel assignment

During cable assembly [▶ 47] note the assignment of the optical channels in the connection socket. In the case of the CU1561 the light-emitting transmitter channel (Tx) is the lower outlet in the connection socket (Fig. *Transmitter channel of the CU1561*).

Be sure to observe the safety instructions [▶ 51] for class 1 lasers!



Fig. 30: Transmitter channel of the CU1561

NOTICE

Use of blind plugs

In order to avoid accidents due to glare (Class 1 laser, please observe the safety instructions [▶ 51]) and to protect the transceiver against environmental influences, unused sockets should be sealed using the blind plugs provided (Fig. *Blind plugs in unused sockets*)



Fig. 31: Blind plugs in unused sockets

5.4 Notes regarding assembly of POF cables with the connector set ZS1090-0008

Table of contents

- [Step-by-step instructions for assembling the POF cable \[▶ 47\]](#)
 1. [Stripping the POF cable \[▶ 47\]](#)
 2. [Attaching the connector \[▶ 48\]](#)
 3. [Grinding and polishing \[▶ 49\]](#)
 4. [Fine polishing \[▶ 50\]](#)



Fig. 32: Duplex connector set ZS1090-0008

The duplex connector set ZS1090-0008 from Beckhoff consists of 10 duplex Versatile Link connectors and several sheets of abrasive paper and polishing paper.

Step-by-step instructions for assembling the POF cable

The following step-by-step guide describes the correct assembly of a POF cable with a Versatile Link duplex connector. The connectors are attached to the cable ends with standard tools such as cutter knife or wire strippers. Polish the assembled cable with the polishing set provided with the connector set, consisting of a plastic sanding gauge, sheets of abrasive paper with grain size 600 and pink polishing sheets. Once assembled, the connector can be used right away.

Materials required:

1. POF cable (Polymeric Optical Fiber, e.g. Z1190 from Beckhoff)
2. Cutter knife or shears
3. Wire strippers
4. Polishing set (included with connector set ZS1090-0008 from Beckhoff)
5. Versatile Link duplex connector (included in connector set ZS1090-0008 from Beckhoff)

1. Stripping the POF cable

The cable should be split over a length between 100 and 150 mm from the cable end, so that the following steps can be carried out properly.

Once you have shortened the cable to the required length, use the wire strippers to remove approx. 7 mm of the external sheathing of the individual wires. The two cable ends should be stripped over approximately the same length. (Fig. *POF cable stripped over the same length*).

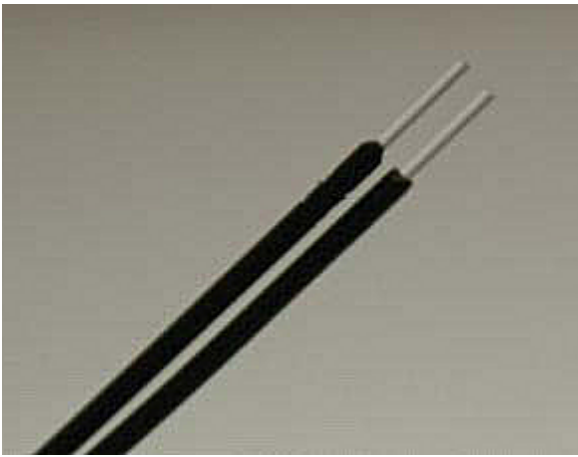

Fig. 33: POF cable stripped over the same length

2. Attaching the connector

Push the two cable ends into the connector and the connector back until it stops. The fibers should now protrude no more than 1.5 mm out of the front openings (Fig. *Cable inserted in the connector*).

Close the connector by folding the upper and lower halves together until they engage (Fig. *Closed connector*).

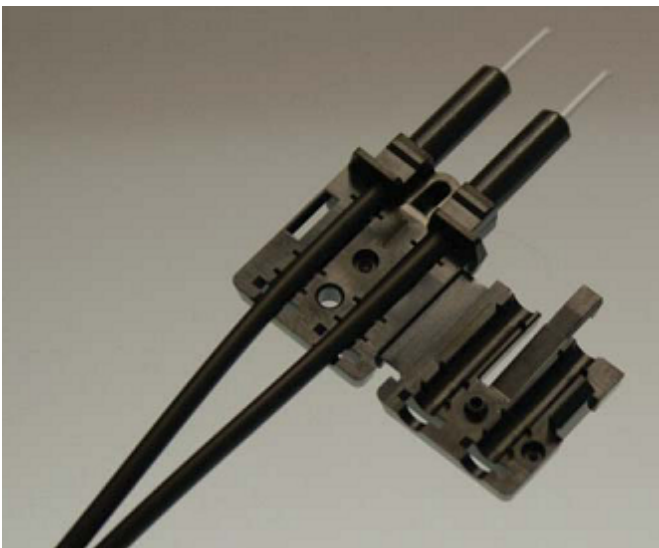

Fig. 34: Cable inserted in the connector

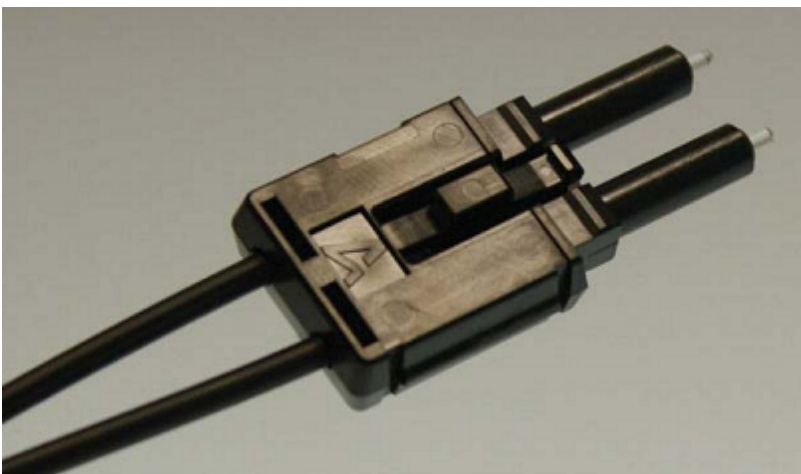

Fig. 35: Closed connector

When inserting the wires into the connector ensure the optical channels are crossed (Tx1 --> Rx2; Tx2 --> Rx1). The 'nose' at the connector hinge can be used as a guide (Fig. *Correctly connected optical channels*).

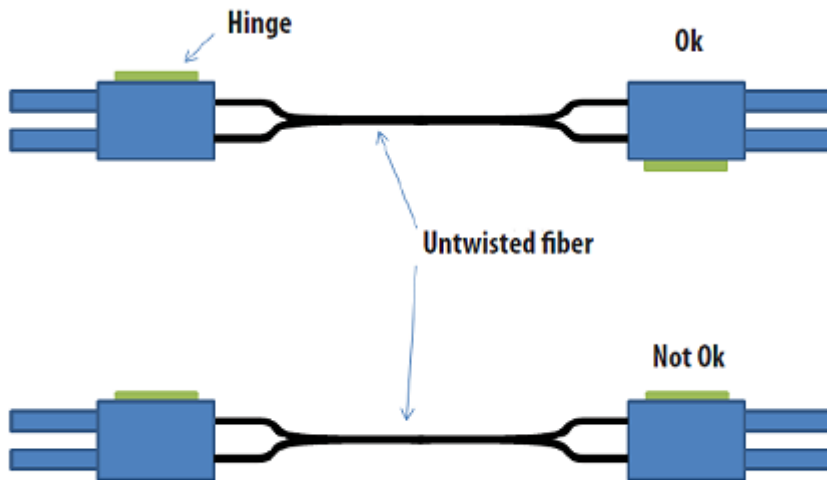

Fig. 36: Correctly connected optical channels

3. Grinding and polishing

Any fibers protruding more than 1.5 mm from the connector should be shortened with a cutter knife or a pair of scissors.

Now push the connector fully into the sanding gauge, so that the ends to be polished protrude from the lower side (Fig. Sanding gauge with protruding fiber ends). The sanding gauge is suitable for polishing one or two simplex connectors or a duplex connector.



Fig. 37: Sanding gauge with protruding fiber ends

● Wear indicator

The wear indicator of the sanding gauge consists of four points on the underside. The sanding gauge should be replaced when one of these points is no longer visible.

Now press the sanding gauge onto the abrasive paper with uniform pressure and as perpendicular as possible. In order to achieve a uniform result, use the abrasive paper in the form of a figure of 8 (Fig. *Polishing in the form of a figure "8"*), until the fibers are flush with the sanding gauge. Then clean the sanding gauge and the connector from below with a soft, dry cloth.

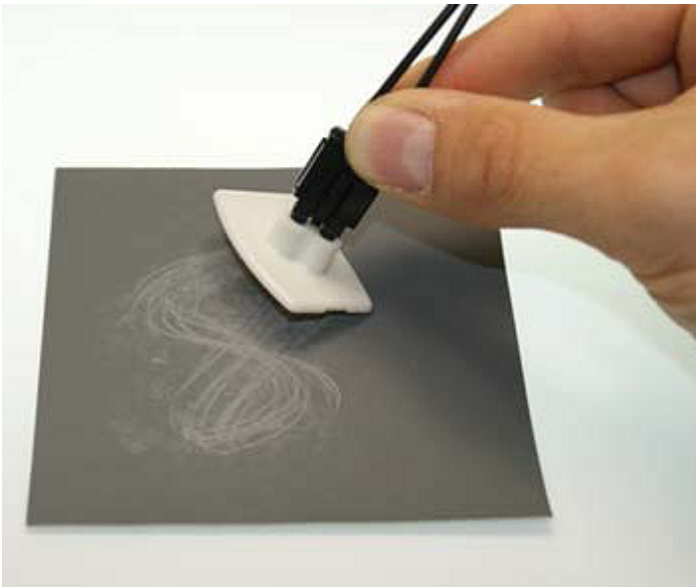

Fig. 38: Polishing in the form of a figure of "8"

4. Fine polishing

Now use the pink polishing sheet for fine polishing in the same manner. Apply the connector with the sanding gauge to the matt side of the polishing sheet with slight pressure and polish in the form of a figure of 8 up to 25 times. After the procedure the fiber end should be flat, smooth and clean.

● Improving the transfer performance by fine polishing

i Fine polishing with a polishing sheet can improve the transfer performance between the transmitter and the receiver or in the cable joint by up to 0.5 dB compared with to treatment with abrasive paper alone. For short transfer distances the polishing step can be omitted.

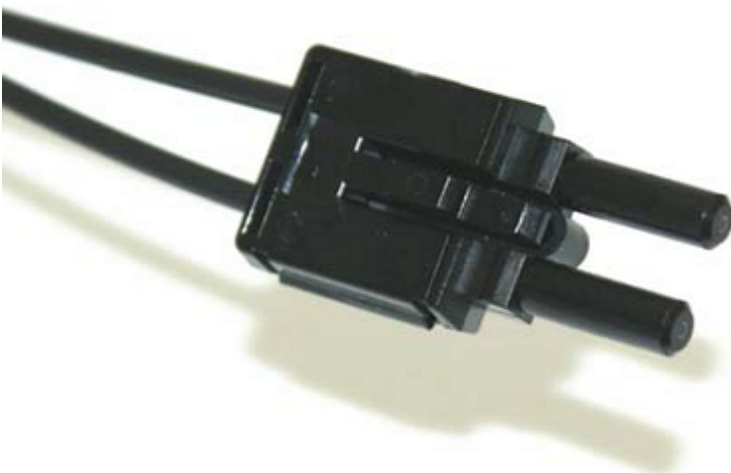

Fig. 39: Fine-polished fibers in the connector

6 Appendix

6.1 Safety instructions and behavioral rules for Class 1 laser

⚠ CAUTION

Class 1 laser product – danger of accident due to glare!

The following laser-specific behavioral rules are to be followed for the Class 1 laser products described in this document:

- The laser beam may not be directed toward persons, since accidents may be caused by glare.
- Do not look into the direct or reflected beam.
- If laser radiation meets the eye, the eyes must be consciously closed and the head turned away from the beam immediately.
- When using the laser, no optical instruments may be used to view the radiation source, since this can lead to exposure limit values being exceeded.
- Manipulations (modifications) of the laser device are not permitted.



Fig. 40: Note

6.2 Firmware compatibility

The firmware of the converters CU1521-00x0, CU1561 cannot be updated.

6.3 Support and Service

Beckhoff and their partners around the world offer comprehensive support and service, making available fast and competent assistance with all questions related to Beckhoff products and system solutions.

Beckhoff's branch offices and representatives

Please contact your Beckhoff branch office or representative for local support and service on Beckhoff products!

The addresses of Beckhoff's branch offices and representatives round the world can be found on her internet pages: www.beckhoff.com

You will also find further documentation for Beckhoff components there.

Support

The Beckhoff Support offers you comprehensive technical assistance, helping you not only with the application of individual Beckhoff products, but also with other, wide-ranging services:

- support
- design, programming and commissioning of complex automation systems
- and extensive training program for Beckhoff system components

Hotline: +49 5246 963 157
e-mail: support@beckhoff.com
web: www.beckhoff.com/support

Service

The Beckhoff Service Center supports you in all matters of after-sales service:

- on-site service
- repair service
- spare parts service
- hotline service

Hotline: +49 5246 963 460
e-mail: service@beckhoff.com
web: www.beckhoff.com/service

Headquarters Germany

Beckhoff Automation GmbH & Co. KG

Hülshorstweg 20
33415 Verl
Germany

Phone: +49 5246 963 0
e-mail: info@beckhoff.com
web: www.beckhoff.com

More Information:
www.beckhoff.com/cuxxxx

Beckhoff Automation GmbH & Co. KG
Hülshorstweg 20
33415 Verl
Germany
Phone: +49 5246 9630
info@beckhoff.com
www.beckhoff.com

