

Documentation | EN

EJ6070

EtherCAT plug-in module, License key for TwinCAT 3.1

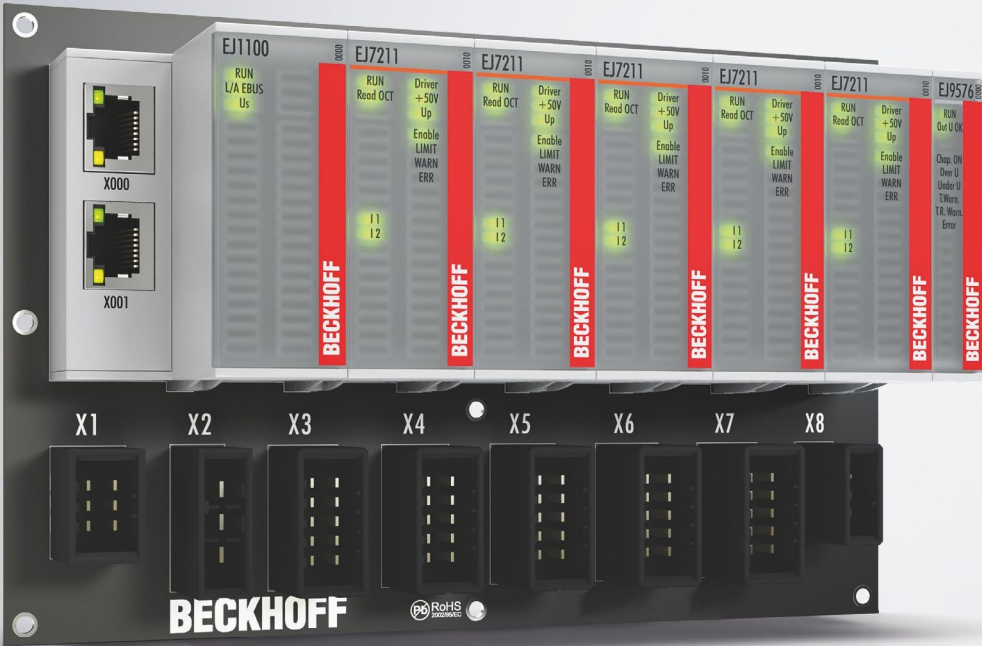

Table of contents

1 Foreword	5
1.1 Notes on the documentation	5
1.2 Safety instructions	6
1.3 Intended use	7
1.4 Signal distribution board.....	7
1.5 Documentation issue status	7
1.6 Guide through documentation	8
1.7 Marking of EtherCAT plug-in modules	8
1.7.1 Beckhoff Identification Code (BIC).....	11
1.7.2 Electronic access to the BIC (eBIC).....	13
1.7.3 Certificates	15
2 System overview	16
3 EJ6070 - Product description	17
3.1 Introduction	17
3.2 Technical data	18
3.3 Pinout	19
3.4 LEDs	20
4 Installation of EJ modules	21
4.1 Power supply for the EtherCAT plug-in modules	21
4.2 EJxxxx - dimensions	23
4.3 Installation positions and minimum distances	24
4.3.1 Minimum distances for ensuring installability	24
4.3.2 Installation positions.....	25
4.4 Codings	27
4.4.1 Color coding	27
4.4.2 Mechanical position coding	28
4.5 Installation on the signal distribution board	29
4.6 Extension options	31
4.6.1 Using placeholder modules for unused slots	31
4.6.2 Linking with EtherCAT Terminals and EtherCAT Box modules via an Ethernet/EtherCAT connection.....	32
4.7 IPC integration	33
4.8 Disassembly of the signal distribution board	35
4.9 Disposal	35
5 EtherCAT basics	36
6 Commissioning	37
6.1 Reference to documentation EL6070.....	37
6.2 EJ6070 - object description and parameterization	37
6.2.1 Restore object	38
6.2.2 Command object (0xB000)	38
6.2.3 Information and diagnostic data	38
6.2.4 Standard objects (0x1000-0x1FFF)	40
7 Appendix	42

7.1 Support and Service..... 42

1 Foreword

1.1 Notes on the documentation

Intended audience

This description is only intended for the use of trained specialists in control and automation engineering who are familiar with the applicable national standards.

It is essential that the documentation and the following notes and explanations are followed when installing and commissioning these components.

It is the duty of the technical personnel to use the documentation published at the respective time of each installation and commissioning.

The responsible staff must ensure that the application or use of the products described satisfy all the requirements for safety, including all the relevant laws, regulations, guidelines and standards.

Disclaimer

The documentation has been prepared with care. The products described are, however, constantly under development.

We reserve the right to revise and change the documentation at any time and without prior announcement.

No claims for the modification of products that have already been supplied may be made on the basis of the data, diagrams and descriptions in this documentation.

Trademarks

Beckhoff®, TwinCAT®, TwinCAT/BSD®, TC/BSD®, EtherCAT®, EtherCAT G®, EtherCAT G10®, EtherCAT P®, Safety over EtherCAT®, TwinSAFE®, XFC®, XTS® and XPlanar® are registered trademarks of and licensed by Beckhoff Automation GmbH. Other designations used in this publication may be trademarks whose use by third parties for their own purposes could violate the rights of the owners.

Patent Pending

The EtherCAT Technology is covered, including but not limited to the following patent applications and patents: EP1590927, EP1789857, EP1456722, EP2137893, DE102015105702 with corresponding applications or registrations in various other countries.

The logo for EtherCAT, featuring the word "EtherCAT" in a bold, black, sans-serif font. A red arrow points from the top of the "A" towards the right, ending above the "T". A registered trademark symbol (®) is located to the right of the "T".

EtherCAT® is registered trademark and patented technology, licensed by Beckhoff Automation GmbH, Germany.

Copyright

© Beckhoff Automation GmbH & Co. KG, Germany.

The reproduction, distribution and utilization of this document as well as the communication of its contents to others without express authorization are prohibited.

Offenders will be held liable for the payment of damages. All rights reserved in the event of the grant of a patent, utility model or design.

1.2 Safety instructions

Safety regulations

Please note the following safety instructions and explanations!
Product-specific safety instructions can be found on following pages or in the areas mounting, wiring, commissioning etc.

Exclusion of liability

All the components are supplied in particular hardware and software configurations appropriate for the application. Modifications to hardware or software configurations other than those described in the documentation are not permitted, and nullify the liability of Beckhoff Automation GmbH & Co. KG.

Personnel qualification

This description is only intended for trained specialists in control, automation and drive engineering who are familiar with the applicable national standards.

Description of instructions

In this documentation the following instructions are used.
These instructions must be read carefully and followed without fail!

DANGER

Serious risk of injury!

Failure to follow this safety instruction directly endangers the life and health of persons.

WARNING

Risk of injury!

Failure to follow this safety instruction endangers the life and health of persons.

CAUTION

Personal injuries!

Failure to follow this safety instruction can lead to injuries to persons.

NOTE

Damage to environment/equipment or data loss

Failure to follow this instruction can lead to environmental damage, equipment damage or data loss.



Tip or pointer

This symbol indicates information that contributes to better understanding.

1.3 Intended use

⚠ WARNING

Caution - Risk of injury!

EJ components may only be used for the purposes described below!

1.4 Signal distribution board

NOTE

Signal distribution board

Make sure that the EtherCAT plug-in modules are used only on a signal distribution board that has been developed and manufactured in accordance with the [Design Guide](#).

1.5 Documentation issue status

Version	Comment
1.1	<ul style="list-style-type: none">• Correction Technical data
1.0	<ul style="list-style-type: none">• First publication EJ6070

1.6 Guide through documentation

NOTE



Further components of documentation

The documentations named in the following table are further components of the complete documentation. These documentations are required for the use of EtherCAT plug-in modules.

No.	Title	Description
[1]	EtherCAT System Documentation	<ul style="list-style-type: none"> • System overview • EtherCAT basics • Cable redundancy • Hot Connect • Distributed Clocks • Configuration of EtherCAT-Components
[2]	Infrastructure for EtherCAT/Ethernet	<ul style="list-style-type: none"> • Technical recommendations and notes for design, implementation and testing
[3]	Design Guide EJ8xxx - Signal distribution board for standard EtherCAT plug-in modules	Requirements for the design of a Signal-Distribution-Board for standard EtherCAT plug-in modules <ul style="list-style-type: none"> • Backplane mounting guidelines • Module placement • Routing guidelines
[4]	Documentation of the corresponding EtherCAT Terminal ELxxxx	<ul style="list-style-type: none"> • Notes on the principle of operation and • Descriptions for configuration and parameterization are transferable to the corresponding Module EJxxxx (s. note on documentation of ELxxxx [▶ 37]).

1.7 Marking of EtherCAT plug-in modules

Designation

A Beckhoff EtherCAT device has a 14-digit **technical designation**, made up as follows (e.g. EJ1008-0000-0017)

- **Order identifier**
 - family key: EJ
 - product designation: The first digit of product designation is used for assignment to a product group (e.g. EJ2xxx = digital output module).
 - Version number: The four digit version number identifies different product variants.
- **Revision number:**
It is incremented when changes are made to the product.

The Order identifier and the revision number are printed on the side of EtherCAT plug-in modules (s. following illustration (A and B)).

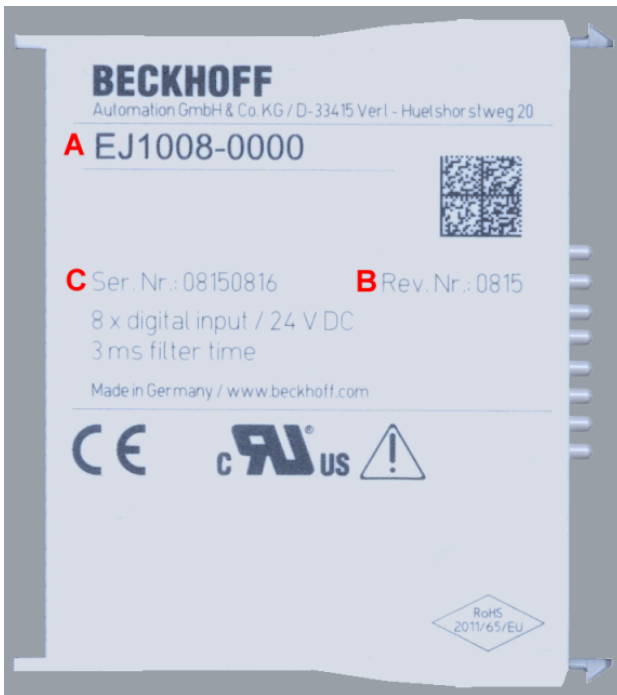

Fig. 1: Order identifier (A), Revision number (B) and serial number (C) using the example of EJ1008

Product group	Example		
	Product designation	Version	Revision
EtherCAT Coupler EJ11xx	EJ1101	-0022 (Coupler with external connectors, power supply module and optional ID switches)	-0016
Digital input modules EJ1xxx	EJ1008 8-channel	-0000 (basic type)	-0017
Digital output modules EJ2xxx	EJ2521 1-channel	-0224 (2 x 24 V outputs)	-0016
Analog input modules EJ3xxx	EJ3318 8-channel thermocouple	-0000 (basic type)	-0017
Analog output modules EJ4xxx	EJ4134 4-channel	-0000 (basic type)	-0019
Special function modules EJ5xxx, EJ6xxx	EJ6224 IO-Link master	-0090 (with TwinSAFE SC)	-0016
Motion modules EJ7xxx	EJ7211 servomotor	-9414 (with ECT, STO and TwinSAFE SC)	-0029

Notes

- The elements mentioned above result in the **technical designation**. EJ1008-0000-0017 is used in the example below.
- EJ1008-0000 is the **order identifier**, in the case of “-0000” usually abbreviated to EJ1008.
- The **revision** -0017 shows the technical progress, such as the extension of features with regard to the EtherCAT communication, and is managed by Beckhoff.
In principle, a device with a higher revision can replace a device with a lower revision, unless specified otherwise, e.g. in the documentation.
Associated and synonymous with each revision there is usually a description (ESI, EtherCAT Slave Information) in the form of an XML file, which is available for [download](#) from the Beckhoff web site.
- The product designation, version and revision are read as decimal numbers, even if they are technically saved in hexadecimal.

Serial number

The serial number for EtherCAT plug-in modules is usually the 8-digit number printed on the side of the module (see following illustration C). The serial number indicates the configuration in delivery state and therefore refers to a whole production batch, without distinguishing the individual modules of a batch.

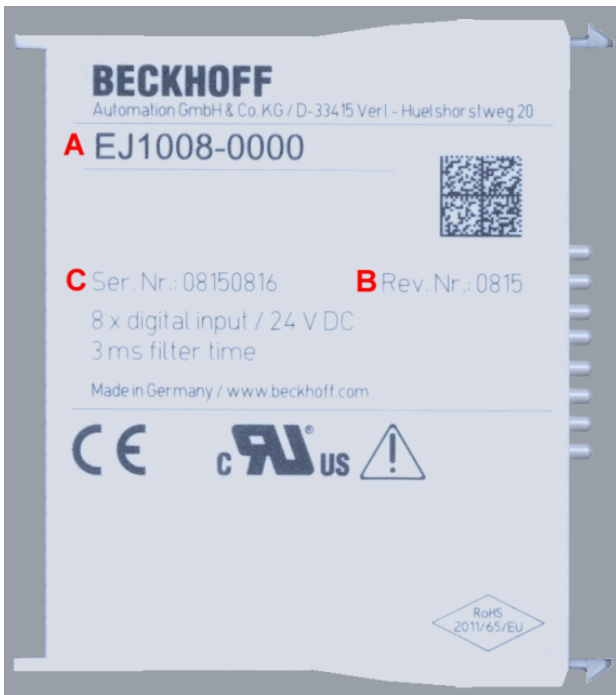

Fig. 2: Order identifier (A), revision number (B) and serial number (C) using the example of EJ1008

Serial number	Example serial number: 08 15 08 16
KK - week of production (CW, calendar week)	08 - week of production: 08
YY - year of production	15 - year of production: 2015
FF - firmware version	08 - firmware version: 08
HH - hardware version	16 - hardware version: 16

1.7.1 Beckhoff Identification Code (BIC)

The **Beckhoff Identification Code (BIC)** is increasingly being applied to Beckhoff products to uniquely identify the product. The BIC is represented as a Data Matrix Code (DMC, code scheme ECC200), the content is based on the ANSI standard MH10.8.2-2016.

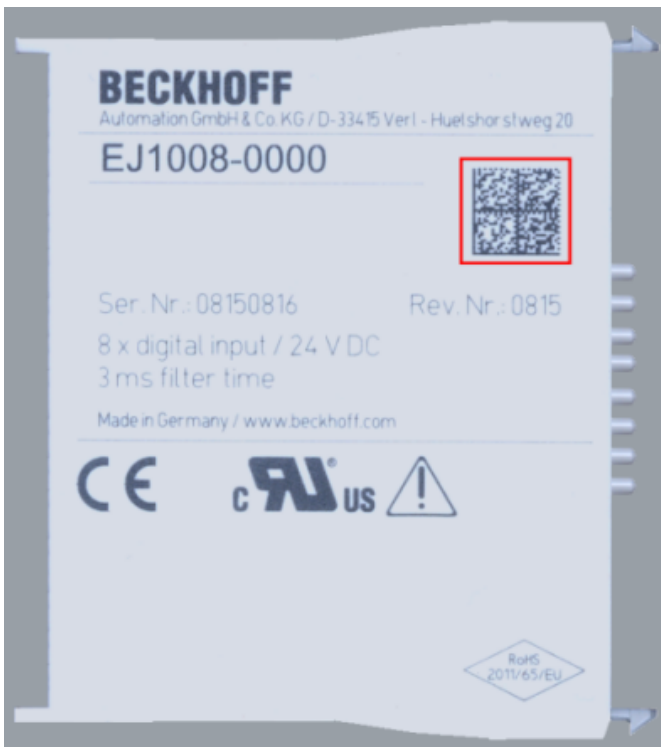

Fig. 3: BIC as data matrix code (DMC, code scheme ECC200)

The BIC will be introduced step by step across all product groups.

Depending on the product, it can be found in the following places:

- on the packaging unit
- directly on the product (if space suffices)
- on the packaging unit and the product

The BIC is machine-readable and contains information that can also be used by the customer for handling and product management.

Each piece of information can be uniquely identified using the so-called data identifier (ANSI MH10.8.2-2016). The data identifier is followed by a character string. Both together have a maximum length according to the table below. If the information is shorter, it shall be replaced by spaces. The data under positions 1-4 are always available.

The following information is contained:

Item no.	Type of information	Explanation	Data identifier	Number of digits incl. data identifier	Example
1	Beckhoff order number	Beckhoff order number	1P	8	1 P072222
2	Beckhoff Traceability Number (BTN)	Unique serial number, see note below	S	12	S BTNk4p562d7
3	Article description	Beckhoff article description, e.g. EL1008	1K	32	1 KEL1809
4	Quantity	Quantity in packaging unit, e.g. 1, 10, etc.	Q	6	Q 1
5	Batch number	Optional: Year and week of production	2P	14	2 P401503180016
6	ID/serial number	Optional: Present-day serial number system, e.g. with safety products	51S	12	51 S678294104
7	Variant number	Optional: Product variant number on the basis of standard products	30P	32	30 PF971 , 2*K183
...					

Further types of information and data identifiers are used by Beckhoff and serve internal processes.

Structure of the BIC

Example of composite information from items 1 - 4 and with the above given example value on position 6. The data identifiers are marked in bold font for better display:

1P072222**S**BTNk4p562d7**1**KEL1809 **Q**1 **51**S678294

Accordingly as DMC:



Fig. 4: Example DMC **1**P072222**S**BTNk4p562d7**1**KEL1809 **Q**1 **51**S678294

BTN

An important component of the BIC is the Beckhoff Traceability Number (BTN, item no. 2). The BTN is a unique serial number consisting of eight characters that will replace all other serial number systems at Beckhoff in the long term (e.g. batch designations on IO components, previous serial number range for safety products, etc.). The BTN will also be introduced step by step, so it may happen that the BTN is not yet coded in the BIC.

NOTE

This information has been carefully prepared. However, the procedure described is constantly being further developed. We reserve the right to revise and change procedures and documentation at any time and without prior notice. No claims for changes can be made from the information, illustrations and descriptions in this information.

1.7.2 Electronic access to the BIC (eBIC)

Electronic BIC (eBIC)

The Beckhoff Identification Code (BIC) is applied to the outside of Beckhoff products in a visible place. If possible, it should also be electronically readable.

Decisive for the electronic readout is the interface via which the product can be electronically addressed.

K-bus devices (IP20, IP67)

Currently, no electronic storage and readout is planned for these devices.

EtherCAT devices (IP20, IP67)

All Beckhoff EtherCAT devices have a so-called ESI-EEPROM, which contains the EtherCAT identity with the revision number. Stored in it is the EtherCAT slave information, also colloquially known as ESI/XML configuration file for the EtherCAT master. See the corresponding chapter in the EtherCAT system manual ([Link](#)) for the relationships.

The eBIC is also stored in the ESI-EEPROM. The eBIC was introduced into the Beckhoff I/O production (terminals, box modules) from 2020; widespread implementation is expected in 2021.

The user can electronically access the eBIC (if existent) as follows:

- With all EtherCAT devices, the EtherCAT master (TwinCAT) can read the eBIC from the ESI-EEPROM
 - From TwinCAT 3.1 build 4024.11, the eBIC can be displayed in the online view.
 - To do this, check the checkbox "Show Beckhoff Identification Code (BIC)" under EtherCAT → Advanced Settings → Diagnostics:

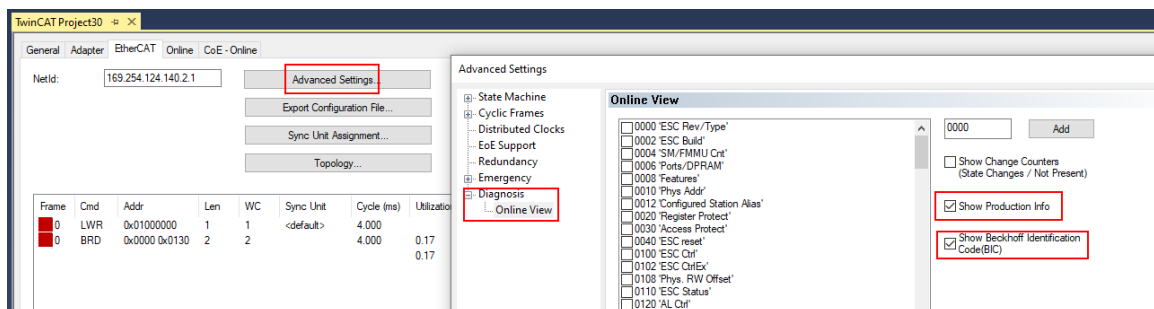

- The BTN and its contents are then displayed:

No	Addr	Name	State	CRC	Fw	Hw	Production Data	ItemNo	BTN	Description	Quantity	BatchNo	SerialNo
1	1001	Term 1 (EK1100)	OP	0,0	0	0	---						
2	1002	Term 2 (EL1018)	OP	0,0	0	0	2020 KW36 Fr	072222	k4p562d7	EL1809	1		678294
3	1003	Term 3 (EL3204)	OP	0,0	7	6	2012 KW24 Sa						
4	1004	Term 4 (EL2004)	OP	0,0	0	0	---	072223	k4p562d7	EL2004	1		678295
5	1005	Term 5 (EL1008)	OP	0,0	0	0	---						
6	1006	Term 6 (EL2008)	OP	0,0	0	12	2014 KW14 Mo						
7	1007	Term 7 (EK1110)	OP	0	1	8	2012 KW25 Mo						

- Note: as can be seen in the illustration, the production data HW version, FW version and production date, which have been programmed since 2012, can also be displayed with "Show Production Info".
- From TwinCAT 3.1. build 4024.24 the functions *FB_EcReadBIC* and *FB_EcReadBTN* for reading into the PLC and further eBIC auxiliary functions are available in the Tc2_EtherCAT Library from v3.3.19.0.
- In the case of EtherCAT devices with CoE directory, the object 0x10E2:01 can additionally be used to display the device's own eBIC; the PLC can also simply access the information here:

- The device must be in SAFEOP/OP for access:

Index	Name	Flags	Value
1000	Device type	RO	0x015E1389 (22942601)
1008	Device name	RO	ELM3704-0000
1009	Hardware version	RO	00
100A	Software version	RO	01
100B	Bootloader version	RO	J0.1.27.0
1011:0	Restore default parameters	RO	> 1 <
1018:0	Identity	RO	> 4 <
10E2:0	Manufacturer-specific Identification C...	RO	> 1 <
10E2:01	SubIndex 001	RO	1P158442SBTN0008jekp1KELM3704 Q1 2P482001000016
10F0:0	Backup parameter handling	RO	> 1 <
10F3:0	Diagnosis History	RO	> 21 <
10F8	Actual Time Stamp	RO	0x170bfb277e

- the object 0x10E2 will be introduced into stock products in the course of a necessary firmware revision.
- From TwinCAT 3.1. build 4024.24 the functions *FB_EcCoEReadBIC* and *FB_EcCoEReadBTN* for reading into the PLC and further eBIC auxiliary functions are available in the *Tc2_EtherCAT Library* from v3.3.19.0.
- Note: in the case of electronic further processing, the BTN is to be handled as a string(8); the identifier "SBTN" is not part of the BTN.
- Technical background
The new BIC information is additionally written as a category in the ESI-EEPROM during the device production. The structure of the ESI content is largely dictated by the ETG specifications, therefore the additional vendor-specific content is stored with the help of a category according to ETG.2010. ID 03 indicates to all EtherCAT masters that they must not overwrite these data in case of an update or restore the data after an ESI update.
The structure follows the content of the BIC, see there. This results in a memory requirement of approx. 50..200 bytes in the EEPROM.
- Special cases
 - If multiple, hierarchically arranged ESCs are installed in a device, only the top-level ESC carries the eBIC Information.
 - If multiple, non-hierarchically arranged ESCs are installed in a device, all ESCs carry the eBIC Information.
 - If the device consists of several sub-devices with their own identity, but only the top-level device is accessible via EtherCAT, the eBIC of the top-level device is located in the CoE object directory 0x10E2:01 and the eBICs of the sub-devices follow in 0x10E2:nn.

Profibus/Profinet/DeviceNet... Devices

Currently, no electronic storage and readout is planned for these devices.

1.7.3 Certificates

- The EtherCAT plug-in modules meet the requirements of the EMC and Low Voltage Directive. The CE mark is printed on the side of the modules.
- The cRUus imprint identifies devices that meet product safety requirements according to U.S. and Canadian regulations.
- The warning symbol is a request to read the corresponding documentation. The documentations for EtherCAT plug-in modules can be downloaded from the Beckhoff [homepage](#).



Fig. 5: Marking for CE and UL using EJ1008 as an example

2 System overview

Electronically, the EJxxxx EtherCAT plug-in modules are based on the EtherCAT I/O system. The EJ system consists of the signal distribution board and EtherCAT plug-in modules. It is also possible to connect an IPC to the EJ system.

The EJ system is suitable for mass production applications, applications with small footprint and applications requiring a low total weight.

The machine complexity can be extended by means of the following:

- reserve slots,
- the use of placeholder modules,
- linking of EtherCAT Terminals and EtherCAT Boxes via an EtherCAT connection.

The following diagram illustrates an EJ system. The components shown are schematic, to illustrate the functionality.

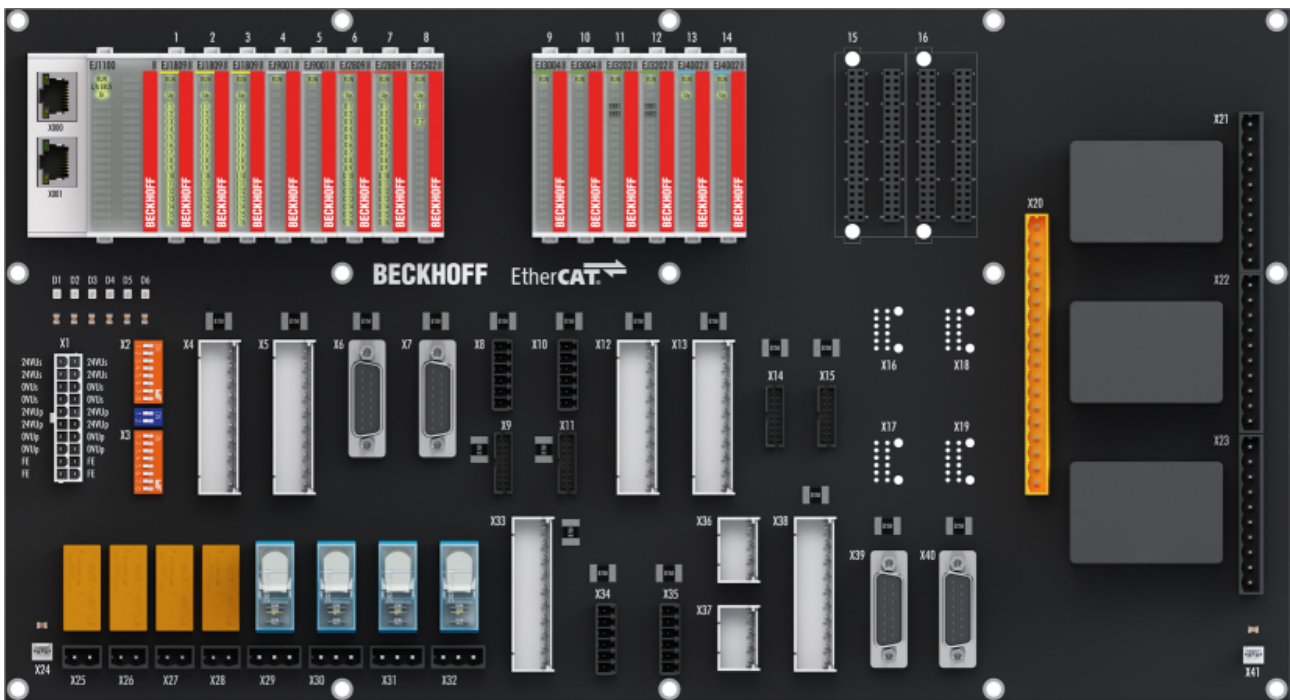

Fig. 6: EJ system sample

Signal distribution board

The signal distribution board distributes the signals and the power supply to individual application-specific plug connectors, in order to connect the controller to further machine modules. Using pre-assembled cable harnesses avoids the need for time-consuming connection of individual wires. Coded components reduce the unit costs and the risk of miswiring.

Beckhoff offers development of signal distribution boards as an engineering service. Customers have the option to develop their own signal distribution board, based on the design guide.

EtherCAT plug-in modules

Similar to the EtherCAT Terminal system, a module strand consists of a bus coupler and I/O modules. Almost all of the EtherCAT Terminals can also be manufactured in the EJ design as EtherCAT plug-in modules. The EJ modules are directly attached to the signal distribution board. The communication, signal distribution and supply take place via the contact pins at the rear of the modules and the PCB tracks of the signal distribution board. The coding pins at the rear serve as mechanical protection against incorrect connection. Color coding on the housing facilitates distinguishing of the modules.

3 EJ6070 - Product description

3.1 Introduction



Fig. 7: EJ6070

EtherCAT plug-in module, License key for TwinCAT 3.1

TwinCAT 3.1 offers an option to manage TwinCAT software licenses via the EtherCAT plug-in module EJ6070. The EJ6070 embodies the hardware license key in the modular EtherCAT I/O system. Data transfer takes place via EtherCAT.

The EJ6070 license key module is equipped with a local data memory for saving TwinCAT 3.1 license files. It is accessed via TwinCAT 3.1. The functionally equivalent C9900-L100 license key USB stick also features this data memory.

Both the EtherCAT plug-in module and the USB stick are available with factory pre-installed licenses: EJ6070-0033, C9900-L100-0033.

i EJ6070 and EJ6070-0033 are not interchangeable

Note that the EJ6070 and EJ6070-0033 are two different devices in terms of EtherCAT and are therefore not interchangeable in the EtherCAT I/O configuration.

3.2 Technical data

Technical data	EJ6070
Technology	EtherCAT license key module
Distributed Clocks (DC)	no
Local memory	1 MByte
Configuration	with TwinCAT System Manager
Current consumption via E-bus	typ. 130 mA
Electrical isolation	500 V (E-Bus/field voltage)
Permissible ambient temperature range during operation	0°C ... + 55°C
Permissible ambient temperature range during storage	-25°C ... + 85°C
Permissible relative humidity	95%, no condensation
Operating altitude	max. 2,000 m
Dimensions (W x H x D)	approx. 12 mm x 66 mm x 55 mm
Weight	approx. 30 g
Mounting	on signal distribution board
Pollution degree	2
Installation position	Standard [▶ 25]
Position of the coding pins [▶ 28]	2 and 5
Color coding	grey
Vibration/shock resistance	conforms to EN 60068-2-6 / EN 60068-2-27 (with corresponding signal distribution board)
EMC immunity/emission	conforms to EN 61000-6-2 / EN 61000-6-4 (with corresponding signal distribution board)
Protection class	EJ module: IP20, EJ system: dependent on signal distribution board and housing
Approvals/markings*	CE, EAC, UKCA

*) Real applicable approvals/markings see type plate on the side (product marking).

● CE approval

i The CE Marking refers to the EtherCAT plug-in module mentioned above. If the EtherCAT plug-in module is used in the production of a ready-to-use end product (PCB in conjunction with a housing), the manufacturer of the end product must check compliance of the overall system with relevant directives and CE certification. To operate the EtherCAT plug-in modules, they must be installed in a housing.

3.3 Pinout

EJ6070			
Pin#		Signal	
1	2	U_{EBUS}	U_{EBUS}
3	4	GND	GND
5	6	RX0+	TX1+
7	8	RX0-	TX1-
9	10	GND	GND
11	12	TX0+	RX1+
13	14	TX0-	RX1-
15	16	GND	GND
17	18	NC	NC
19	20	NC	NC
21	22	NC	NC
23	24	NC	NC
25	26	NC	NC
27	28	NC	NC
29	30	NC	NC
31	32	NC	NC
33	34	NC	NC
35	36	NC	NC
37	38	NC	NC
39	40	SGND	SGND

E-Bus contacts

The power supply U_{EBUS} is provided by the coupler and supplied from the supply voltage U_S of the EtherCAT coupler.

Signals

U_P -Contacts

The device has no U_P -contacts. The power is supplied exclusively via U_{EBUS} .

Signal	Description
U_{EBUS}	E-Bus power supply 3.3 V
GND	E-Bus GND signal. Don't connect with 0V Up!
RXn+	Positive E-Bus receive signal
RXn-	Negative E-Bus receive signal
TXn+	Positive E-Bus transmit signal
TXn-	Negative E-Bus transmit signal
NC	Do not connect
SGND	Shield Ground

Fig. 8: EJ6070 - Pinout

The PCB footprint can be downloaded from the Beckhoff [homepage](#).

NOTE	
	<p>Damage to devices possible!</p> <ul style="list-style-type: none"> • The pins named with “NC” must not be connected. • Before installation and commissioning read the chapters Installation of EJ modules [▶ 21] and Commissioning [▶ 37]!

3.4 LEDs

LED No.	EJ6070
A	RUN
B	
C	
1	PROC
2	INIT
3	ERR
4	
5	
6	
7	
8	
9	
10	
11	
12	
13	
14	
15	
16	

Fig. 9: EJ6070 - LEDs

LED	Color	Display	State	Description
RUN	green	off	Init	State of the EtherCAT State Machine: INIT = initialization of the plug-in module
		flashing	Pre-Operational	State of the EtherCAT State Machine: PREOP = function for mailbox communication and different standard-settings set
		Single flash	Safe-Operational	State of the EtherCAT State Machine: SAFEOP = verification of the Sync Manager channels and the distributed clocks. Outputs remain in safe state
		on	Operational	State of the EtherCAT State Machine: OP = normal operating state; mailbox and process data communication is possible
		flickering	Bootstrap	State of the EtherCAT State Machine: BOOTSTRAP = function for firmware updates of the plug-in module
PROC	green	Cryptographic process is executed		
INIT	yellow	The EtherCAT plug-in module initialize its data and changes to a receiving state		
ERR	red	Error while cryptographic initialization phase or ongoing cryptographic process		

4 Installation of EJ modules

4.1 Power supply for the EtherCAT plug-in modules

⚠ WARNING

Power supply from SELV/PELV power supply unit!

SELV/PELV circuits (Safety Extra Low Voltage, Protective Extra Low Voltage) according to IEC 61010-2-201 must be used to supply this device.

Notes:

- SELV/PELV circuits may give rise to further requirements from standards such as IEC 60204-1 et al, for example with regard to cable spacing and insulation.
- A SELV (Safety Extra Low Voltage) supply provides safe electrical isolation and limitation of the voltage without a connection to the protective conductor, a PELV (Protective Extra Low Voltage) supply also requires a safe connection to the protective conductor.

The signal distribution board should have a power supply designed for the maximum possible current load of the module string. Information on the current required from the E-bus supply can be found for each module in the respective documentation in section “Technical data”, online and in the catalog. The power requirement of the module string is displayed in the TwinCAT System Manager.

E-bus power supply with EJ1100 or EJ1101-0022 and EJ940x

The EJ1100 Bus Coupler supplies the connected EJ modules with the E-bus system voltage of 3.3 V. The Coupler can accommodate a load up to 2.2 A. If a higher current is required, a combination of the coupler EJ1101-0022 and the power supply units EJ9400 (2.5 A) or EJ9404 (12 A) should be used. The EJ940x power supply units can be used as additional supply modules in the module string.

Depending on the application, the following combinations for the E-bus supply are available:

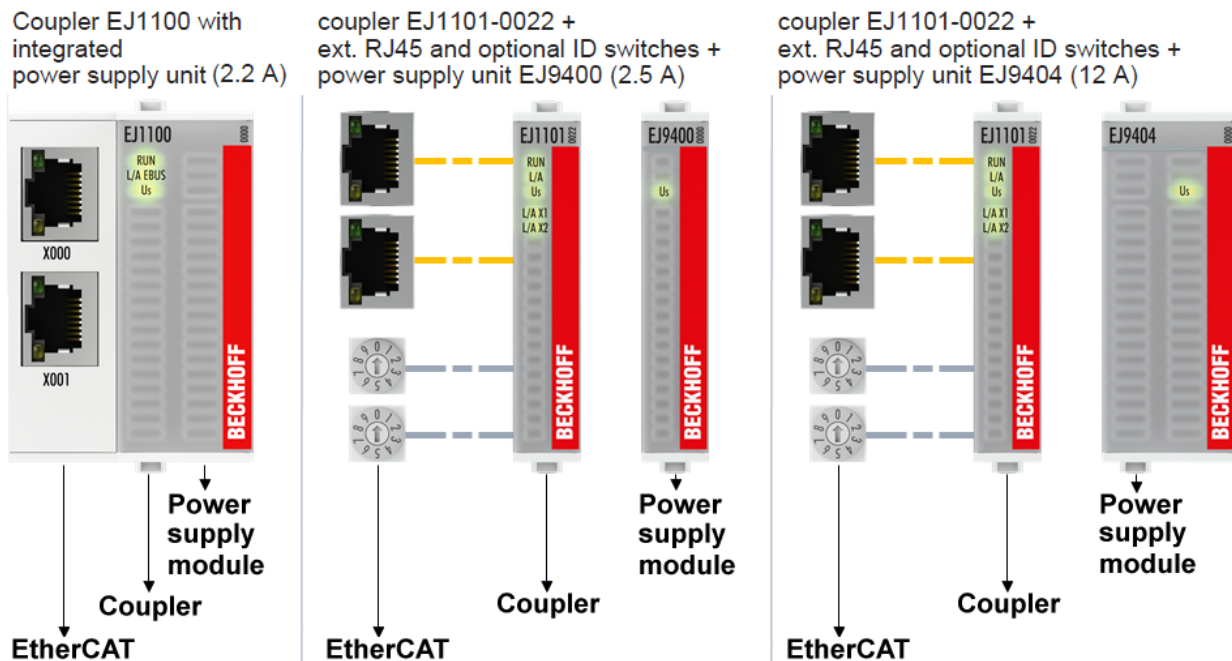

Fig. 10: E-bus power supply with EJ1100 or EJ1101-0022 + EJ940x

In the EJ1101-0022 coupler, the RJ45 connectors and optional ID switches are external and can be positioned anywhere on the signal distribution board, as required. This facilitates feeding through a housing.

The EJ940x power supply plug-in modules provide an optional reset function (see chapter Connection of the documentation for EJ9400 and EJ9404)

E-bus power supply with CXxxxx and EK1110-004x

The Embedded PC supplies the attached EtherCAT Terminals and the EtherCAT EJ coupler

- with a supply voltage U_s of 24 V_{DC} (-15 %/+20%). This voltage supplies the E-bus and the bus terminal electronics.
The CXxxxx units supply the E-bus with up to 2,000 mA E-bus current. If a higher current is required due to the attached terminals, power feed terminals or power supply plug-in modules must be used for the E-bus supply.
- with a peripheral voltage U_p of 24 V_{DC} to supply the field electronics.

The EK1110-004x EtherCAT EJ couplers relay the following parameters to the signal distribution board via the rear connector:

- the E-bus signals,
- the E-bus voltage U_{EBUS} (3.3 V) and
- the peripheral voltage U_p (24 V_{DC}).



Fig. 11: PCB with Embedded PC, EK1110-0043 and EJxxxx, rear view EK1110-0043

4.2 EJxxxx - dimensions

The EJ modules are compact and lightweight thanks to their design. Their volume is approx. 50% smaller than the volume of the EL terminals. A distinction is made between four different module types, depending on the width and the height:

Module type	Dimensions (W x H x D)	Sample in figure below
Coupler	44 mm x 66 mm x 55 mm	EJ1100 (ej_44_2xrxj45_coupler)
Single module	12 mm x 66 mm x 55 mm	EJ1809 (ej_12_16pin_code13)
Double module	24 mm x 66 mm x 55 mm	EJ7342 (ej_24_2x16pin_code18)
Single module (long)	12 mm x 152 mm x 55 mm	EJ1957 (ej_12_2x16pin_extended_code4747)

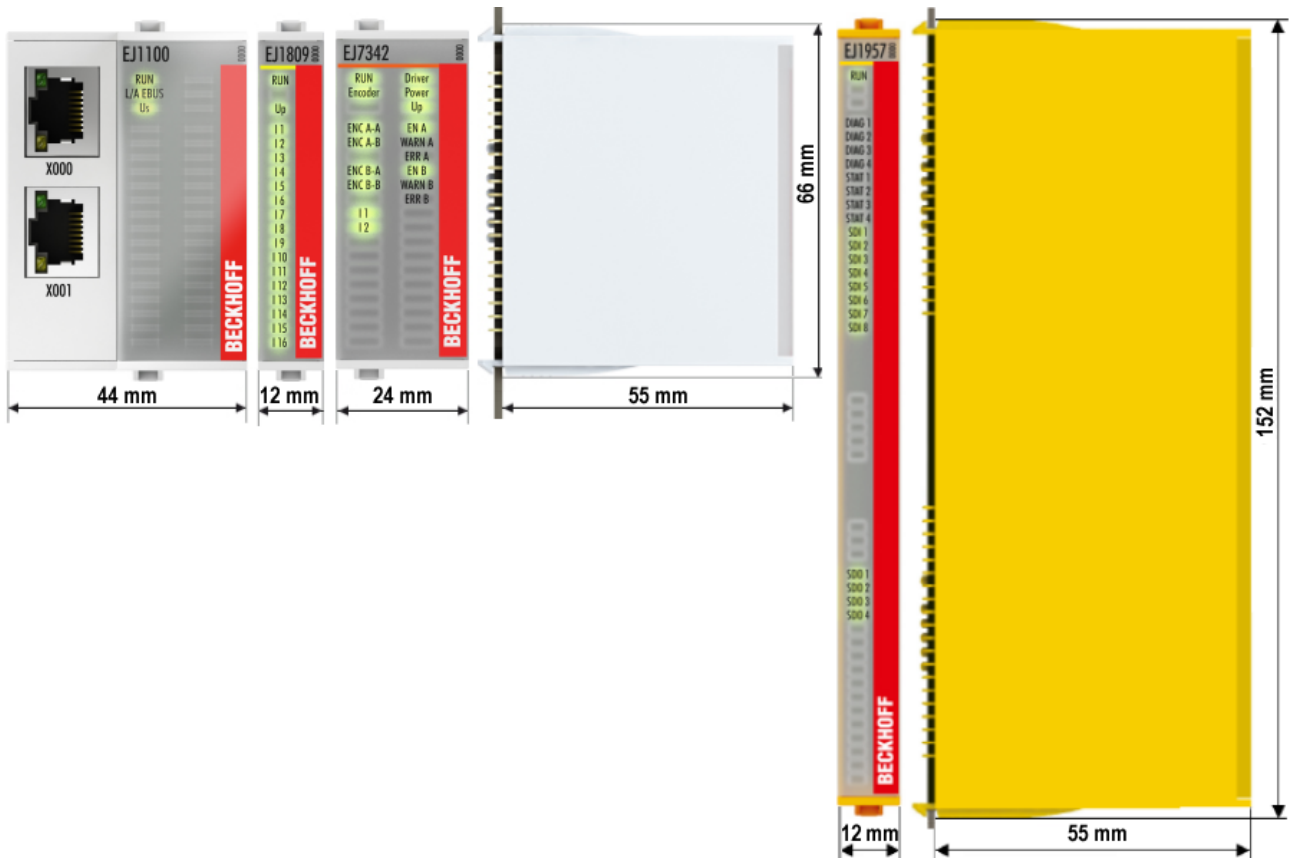

Fig. 12: EJxxxx - Dimensions

The technical drawings can be downloaded from the Beckhoff [homepage](#). The drawings are named as described in the drawing below.



Fig. 13: Naming of the technical drawings

4.3 Installation positions and minimum distances

4.3.1 Minimum distances for ensuring installability

Note the dimensions shown in the following diagram for the design of the signal distribution board to ensure safe latching and simple assembly / disassembly of the modules.

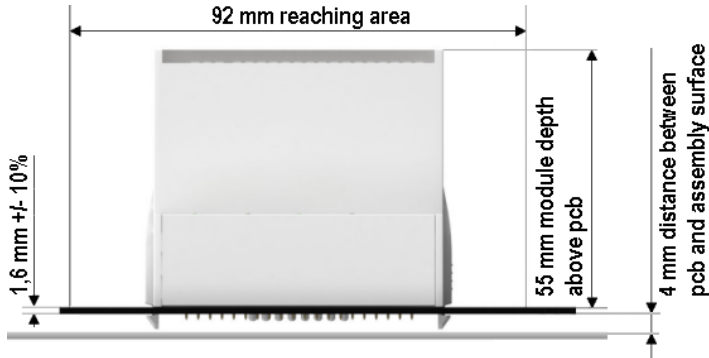

Fig. 14: Mounting distances EJ module - PCB

i Observing the reaching area

A minimum reaching area of 92 mm is required for assembly / disassembly, in order to be able to reach the mounting tabs with the fingers.

Adherence to the recommended minimum distances for ventilation (see [section Installation position \[▶ 25\]](#)) ensures an adequate reaching area.

The signal distribution board must have a thickness of 1.6 mm and a minimum distance of 4 mm from the mounting surface, in order to ensure latching of the modules on the board.

4.3.2 Installation positions

NOTE

Constraints regarding installation position and operating temperature range

Please refer to the [technical data](#) [► 18] for the installed components to ascertain whether any restrictions regarding the mounting position and/or the operating temperature range have been specified. During installation of modules with increased thermal dissipation, ensure adequate distance above and below the modules to other components in order to ensure adequate ventilation of the modules during operation!

The standard installation position is recommended. If a different installation position is used, check whether additional ventilation measures are required.

Ensure that the specified conditions (see Technical data) are adhered to!

Optimum installation position (standard)

For the optimum installation position the signal distribution board is installed horizontally, and the fronts of the EJ modules face forward (see Fig. *Recommended distances for standard installation position*). The modules are ventilated from below, which enables optimum cooling of the electronics through convection. “From below” is relative to the acceleration of gravity.

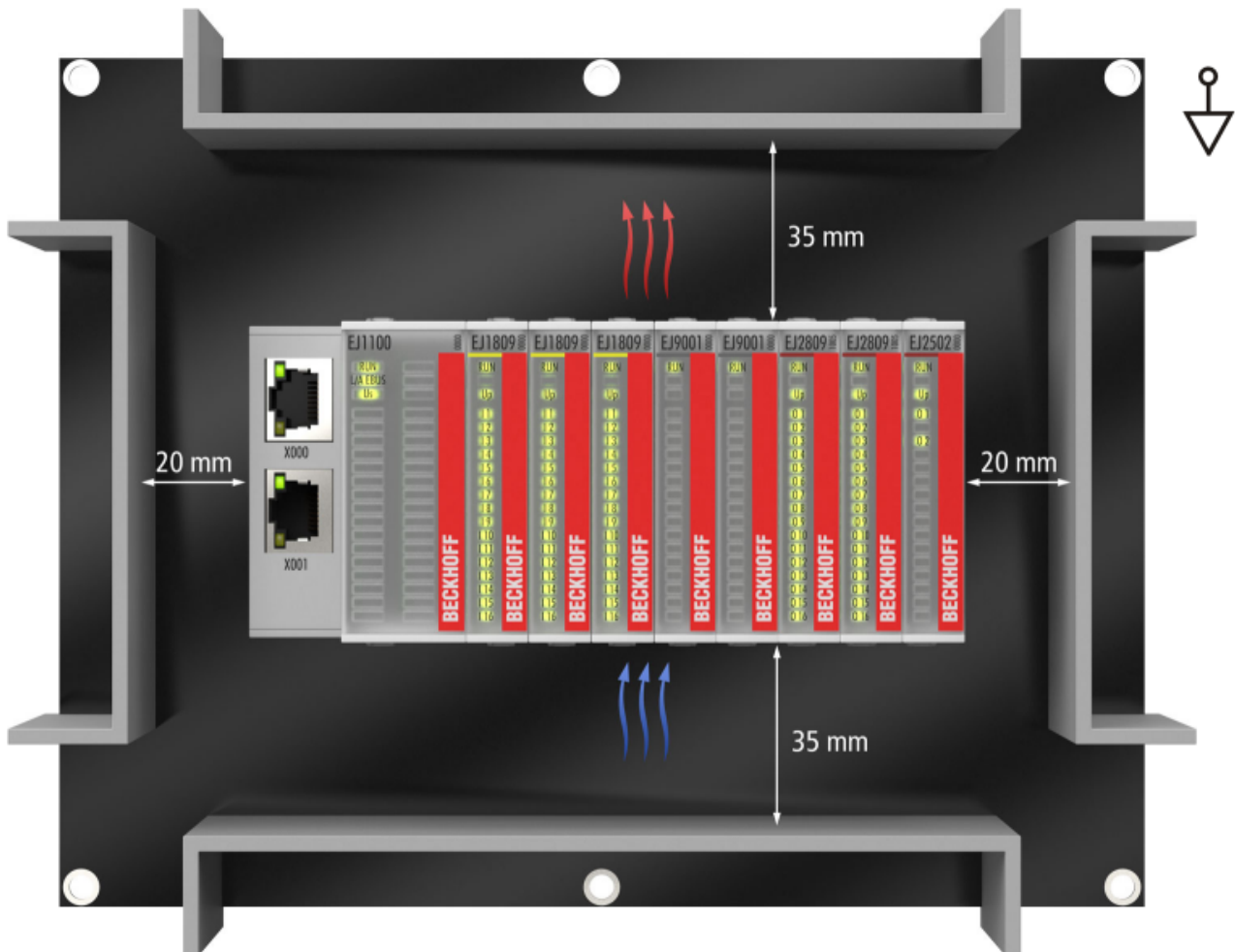

Fig. 15: Recommended distances for standard installation position

Compliance with the distances shown in Fig. *Recommended distances for standard installation position* is recommended. The recommended minimum distances should not be regarded as restricted areas for other components. The customer is responsible for verifying compliance with the environmental conditions described in the technical data. Additional cooling measures must be provided, if required.

Other installation positions

All other installation positions are characterized by a different spatial position of the signal distribution board, see Fig. *Other installation positions*.

The minimum distances to ambient specified above also apply to these installation positions.

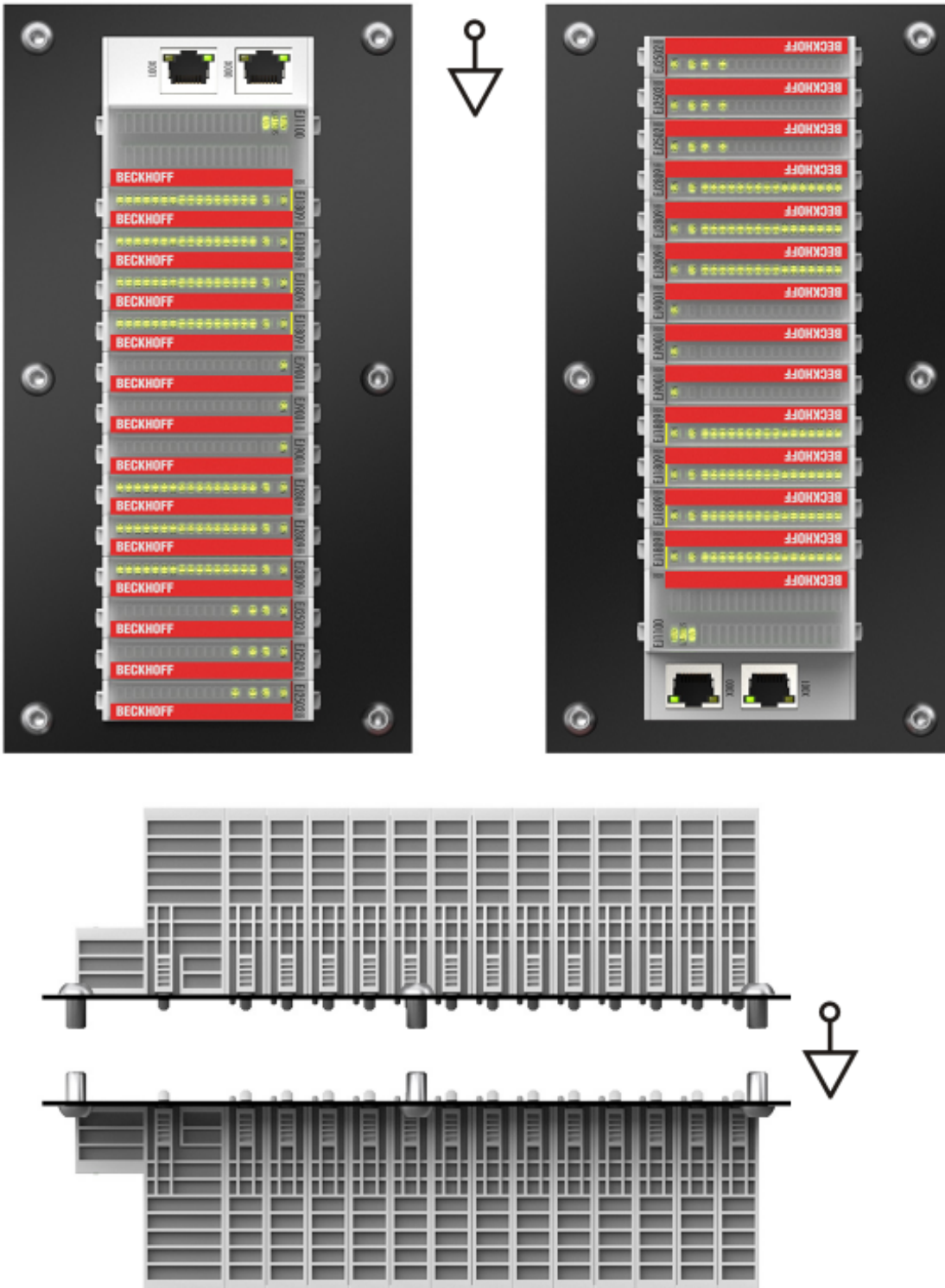

Fig. 16: Other installation positions

4.4 Codings

4.4.1 Color coding

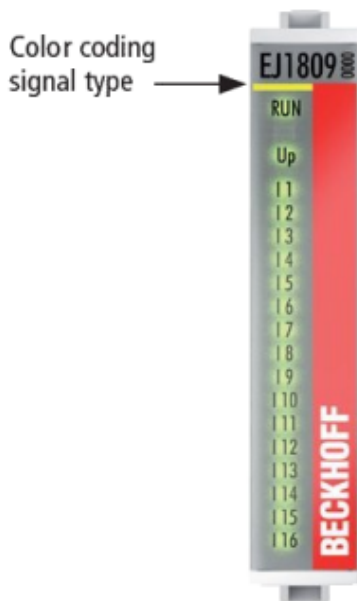

Fig. 17: EJ modules color code; sample: EJ1809

The EJ modules are color-coded for a better overview in the control cabinet (see diagram above). The color code indicates the signal type. The following table provides an overview of the signal types with corresponding color coding.

Signal type	Modules	Color
Coupler	EJ11xx	No color coding
Digital input	EJ1xxx	Yellow
Digital output	EJ2xxx	Red
Analog input	EJ3xxx	Green
Analog output	EJ4xxx	Blue
Position measurement	EJ5xxx	grey
Communication	EJ6xxx	grey
Motion	EJ7xxx	orange
System	EJ9xxx	grey

4.4.2 Mechanical position coding

The modules have two signal-specific coding pins on the underside (see Figs. B1 and B2 below). In conjunction with the coding holes in the signal distribution board (see Figs. A1 and A2 below), the coding pins provide an option for mechanical protection against incorrect connection. This significantly reduces the risk of error during installation and service.

Couplers and placeholder modules have no coding pins.

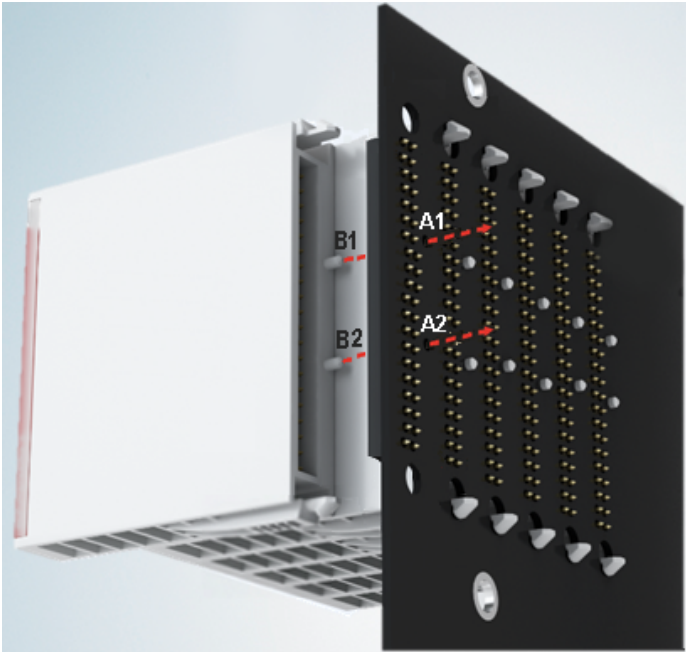

Fig. 18: Mechanical position coding with coding pins (B1 and B2) and coding holes (A1 and A2)

The following diagram shows the position of the position coding with position numbers on the left-hand side. Modules with the same signal type have the same coding. For sample, all digital input modules have the coding pins at positions one and three. There is no plug protection between modules with the same signal type. During installation the module type should therefore be verified based on the device name.

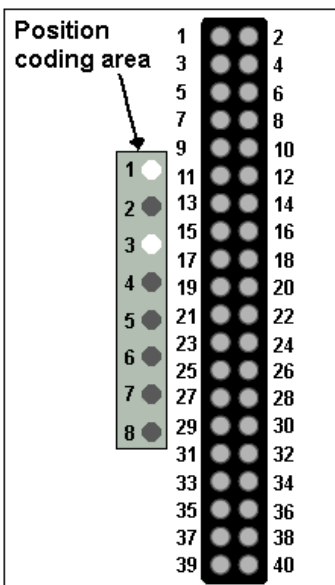

Fig. 19: Pin coding; sample: digital input modules

4.5 Installation on the signal distribution board

EJ modules are installed on the signal distribution board. The electrical connections between coupler and EJ modules are realized via the pin contacts and the signal distribution board.

The EJ components must be installed in a control cabinet or enclosure which must provide protection against fire hazards, environmental conditions and mechanical impact.

⚠ WARNING

Risk of injury through electric shock and damage to the device!

Bring the module system into a safe, de-energized state before starting installation, disassembly or wiring of the modules.

NOTE

Risk of damage to components through electrostatic discharge!

Observe the regulations for ESD protection.

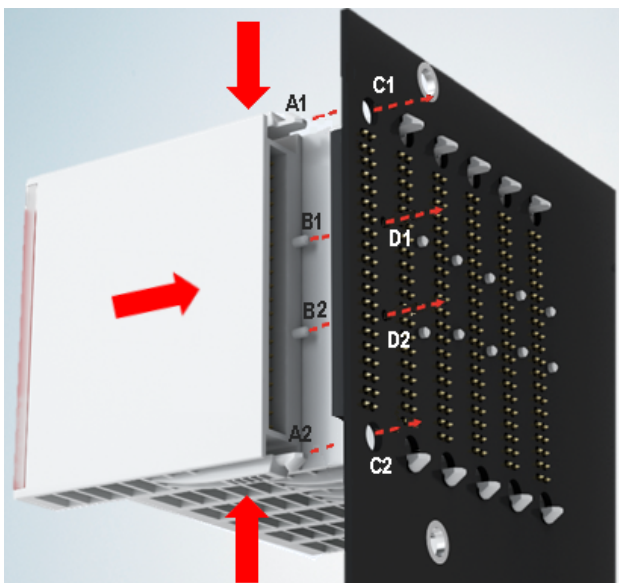

Fig. 20: Installation of EJ modules

A1 / A2	Latching lugs top / bottom	C1 / C2	Mounting holes
B1 / B2	Coding pins	D1 / D2	Coding holes

To install the modules on the signal distribution board proceed as follows:

1. Before the installation, ensure that the signal distribution board is securely connected to the mounting surface. Installation on an unsecured signal distribution board may result in damage to the board.
2. If necessary, check whether the positions of the coding pins (B) match the corresponding holes in the signal distribution board (D).
3. Compare the device name on the module with the information in the installation drawing.
4. Press the upper and the lower mounting tabs simultaneously and push the module onto the board while gently moving it up and down, until the module is latched securely.
The required contact pressure can only be established and the maximum current carrying capacity ensured if the module is latched securely.
5. Use placeholder modules (EJ9001) to fill gaps in the module strand.

NOTE

- During installation ensure safe latching of the modules on the signal distribution board! The consequences of inadequate contact pressure include:
 - ⇒ loss of quality of the transferred signals,
 - ⇒ increased power dissipation of the contacts,
 - ⇒ impairment of the service life.

4.6 Extension options

Three options are available for modifications and extensions of the EJ system.

- Replacing the placeholder modules with the function modules provided for the respective slot
- Assigning function modules specified for the respective slots for the reserve slots at the end of the module string
- Linking with EtherCAT Terminals and EtherCAT Box modules via an Ethernet/EtherCAT connection

4.6.1 Using placeholder modules for unused slots

The EJ9001 placeholder modules are used to close temporary gaps in the module strands (see Fig. A1 below). Gaps in the module strand cause interruption in EtherCAT communication and must be equipped with placeholder modules.

In contrast to the passive terminals of the EL series, the placeholder modules actively participate in the data exchange. Several placeholder modules can therefore be connected in series, without impairing the data exchange.

Unused slots at the end of the module strand can be left as reserve slots (see Fig. B1 below).

The machine complexity is extended (extended version) by allocating unused slots (see Figs. A2 below - Exchanging placeholder modules and B2 - Assigning reserve slots) according to the specifications for the signal distribution board.

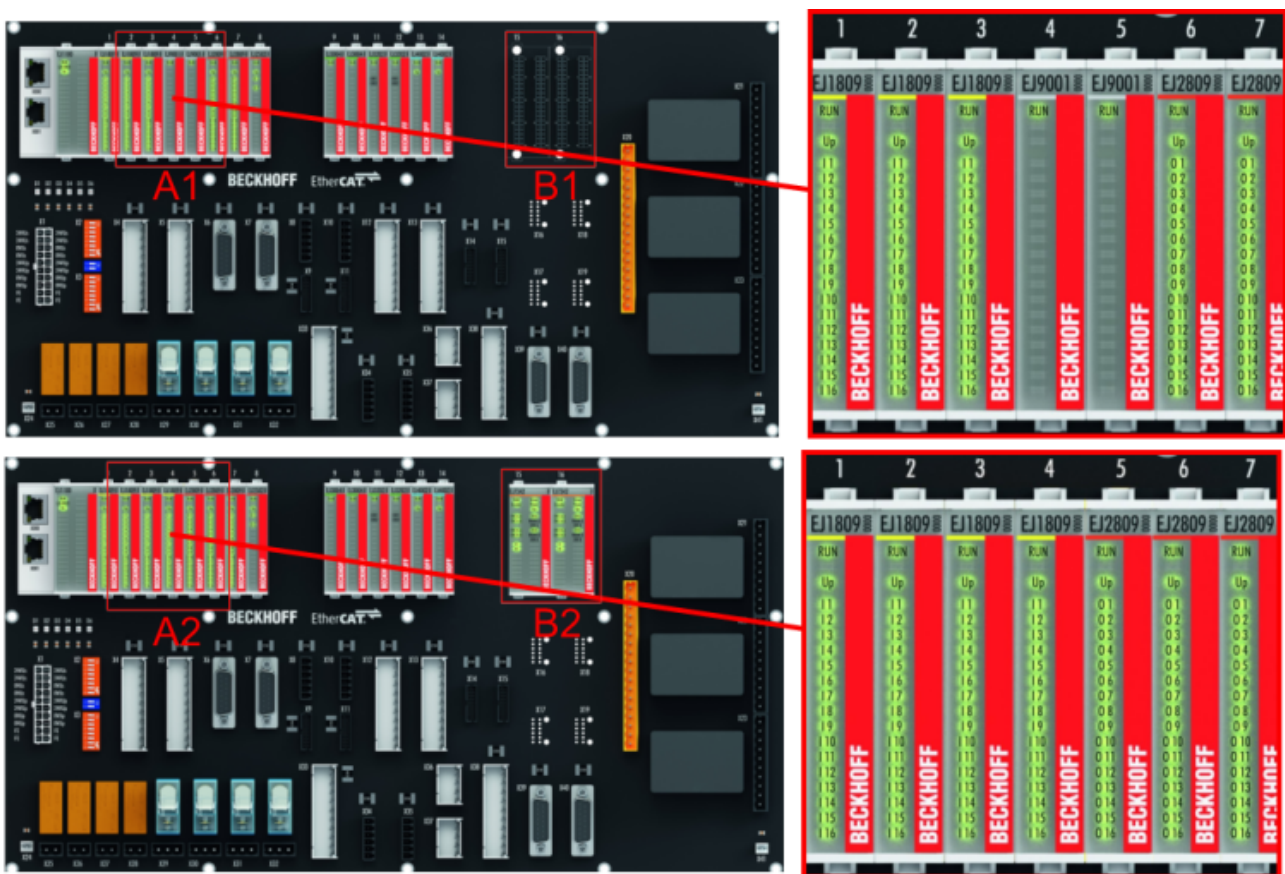

Fig. 21: Sample: Exchanging placeholder modules and assigning reserve slots

i E-bus supply

Exchange the placeholder modules with other modules changes the current input from the E-Bus. Ensure that adequate power supply is provided.

4.6.2 Linking with EtherCAT Terminals and EtherCAT Box modules via an Ethernet/EtherCAT connection

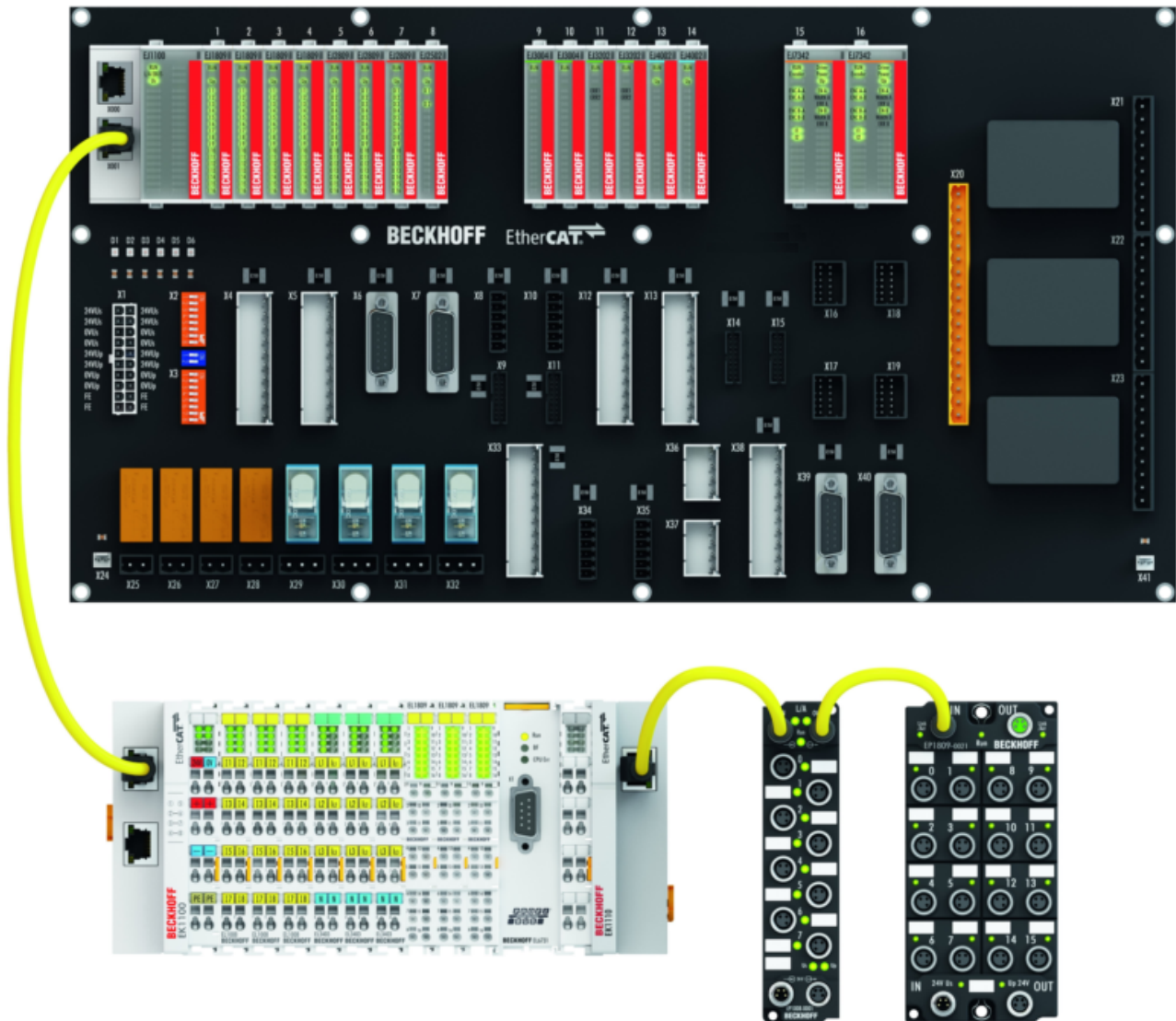

Fig. 22: Example of extension via an Ethernet/EtherCAT connection

4.7 IPC integration

Connection of CX and EL terminals via the EK1110-004x EtherCAT EJ coupler

The EK1110-0043 and EK1110-0044 EtherCAT EJ couplers connect the compact DIN-rail PCs of the CX series and attached EtherCAT Terminals (ELxxxx) with the EJ modules on the signal distribution board.

The EK1110-004x are supplied from the power supply unit of the Embedded PC.

The E-bus signals and the supply voltage of the field side U_p are routed directly to the PCB via a plug connector at the rear of the EtherCAT EJ couplers.

Due to the direct coupling of the Embedded PC and the EL terminals with the EJ modules on the PCB, no EtherCAT Extension (EK1110) or EtherCAT Coupler (EJ1100) is required.

The Embedded PC can be expanded with EtherCAT Terminals that are not yet available in the EJ system, for example.



Fig. 23: Example PCB with Embedded PC, EK1110-0043 and EJxxxx, rear view EK1110-0043

Connection of C6015 / C6017 via the EJ110x-00xx EtherCAT Coupler

Thanks to their ultra-compact design and versatile mounting options, the C6015 and C6017 IPCs are ideally suited for connection to an EJ system.

In combination with the ZS5000-0003 mounting set, it is possible to place the C6015 and C6017 IPCs compactly on the signal distribution board.

The EJ system is optimally connected to the IPC via the corresponding EtherCAT Cable (see following Fig. [A]).

The IPC can be supplied directly via the signal distribution board using the enclosed power plug (see Fig. [B] below).

NOTE



Positioning on the signal distribution board

The dimensions and distances for placement and other details can be found in the Design Guide and the documentation for the individual components.

The figure below shows the connection of a C6015 IPC to an EJ system as an example. The components shown are schematic, to illustrate the functionality.



Fig. 24: Example for the connection of a C6015 IPC to an EJ system

4.8 Disassembly of the signal distribution board

⚠ WARNING

Risk of injury through electric shock and damage to the device!

Bring the module system into a safe, de-energized state before starting installation, disassembly or wiring of the modules.

NOTE

Risk of damage to components through electrostatic discharge!

Observe the regulations for ESD protection.

Each module is secured through latching on the distribution board, which has to be released for disassembly.

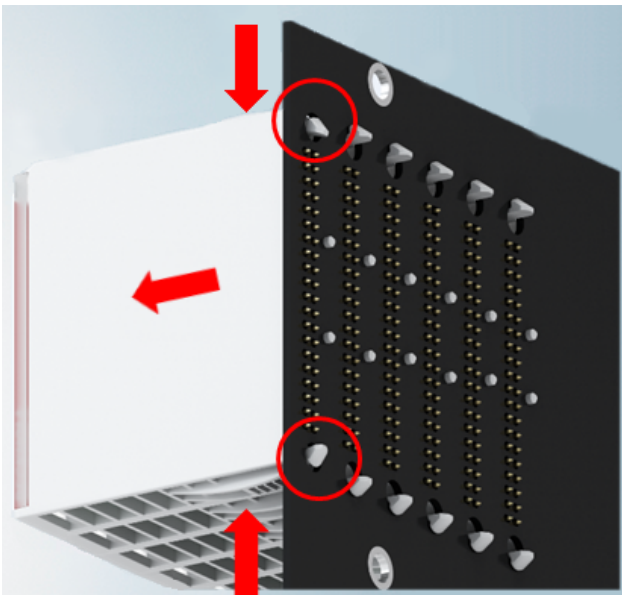

Fig. 25: Disassembly of EJ modules

To disassemble the module from the signal distribution board proceed as follows:

1. Before disassembly, ensure that the signal distribution board is securely connected to the mounting surface. Disassembly of an unsecured signal distribution board may result in damage to the board.
2. Press the upper and lower mounting tabs simultaneously and pull the module from board while gently moving it up and down.

4.9 Disposal



Products marked with a crossed-out wheeled bin shall not be discarded with the normal waste stream. The device is considered as waste electrical and electronic equipment. The national regulations for the disposal of waste electrical and electronic equipment must be observed.

5 EtherCAT basics

Please refer to the [EtherCAT System Documentation](#) for the EtherCAT fieldbus basics.

6 Commissioning

6.1 Reference to documentation EL6070

Detailed documentation on the commissioning of the EJ6070 module is being prepared.

NOTE



Damage to devices or loss of data

The descriptions and notes on the commissioning of the EL6070 EtherCAT Terminals are transferable to the EJ6070 EtherCAT plug-in module.

Before commissioning, read the detailed description of the process data, operation modes and parameterization in the [EL6070](#) documentation.

6.2 EJ6070 - object description and parameterization

● EtherCAT XML Device Description

i The display matches that of the CoE objects from the EtherCAT [XML](#) Device Description. We recommend downloading the latest XML file from the download area of the Beckhoff website and installing it according to installation instructions.

● Parameterization via the CoE list (CAN over EtherCAT)

i The EtherCAT device is parameterized via the CoE - Online tab (with a double click on the respective object) or via the Process Data tab (assignment of PDOs). A detailed description can be found in the EtherCAT System-Documentation in chapter "[EtherCAT subscriber configuration](#)". Please note the general CoE notes in the EtherCAT System Documentation in chapter "[CoE-interface](#)" when using/manipulating the CoE parameters:

- Keep a startup list if components have to be replaced
- Differentiation between online/offline dictionary, existence of current XML description
- use "CoE reload" for resetting changes

Introduction

The CoE overview contains objects for different intended applications:

- Objects required for parameterization during commissioning:
 - [Restore object](#) [[▶ 38](#)] index 0x1011
 - [Configuration data](#) [[▶ 38](#)] index 0x80n0
- Profile-specific objects:
 - [Information and diagnostic](#) [[▶ 38](#)] data Index 0xF000, 0xF008, 0xF010
- [Standard objects](#) [[▶ 40](#)]

The following section first describes the objects required for normal operation, followed by a complete overview of missing objects.

6.2.1 Restore object

Index 1011 Restore default parameters

Index (hex)	Name	Meaning	Data type	Flags	Default
1011:0	Restore default parameters	Restore default parameters	UINT8	RO	0x01 (1 _{dec})
1011:01	SubIndex 001	If this object is set to "0x64616F6C" in the set value dialog, all backup objects are reset to their delivery state.	UINT32	RW	0x00000000 (0 _{dec})

6.2.2 Command object (0xB000)

Index B000 LIC Command

Index (hex)	Name	Meaning	Data type	Flags	Default
B000:0	LIC Command	Max. Subindex (hex)	UINT8	RO	0x03 (3 _{dec})
B000:01	Request	The Object command can be used to trigger various actions.	OCTET-STRING [2]	RW	{0}
B000:02	Status	Status of the command currently being executed 1: Command executed without error and with response 255: Command is being executed	UINT8	RO	0x00 (0 _{dec})
B000:03	Response	Optional return value of the command	OCTET-STRING [4]	RO	{0}

6.2.3 Information and diagnostic data

Index 10F3 Diagnosis History

Index (hex)	Name	Meaning	Data type	Flags	Default
10F3:0	Diagnosis History	Max. Subindex	UINT8	RO	0x37 (55 _{dec})
10F3:01	Maximum Messages	Maximum number of stored messages. A maximum of 50 messages can be stored	UINT8	RO	0x00 (0 _{dec})
10F3:02	Newest Message	Subindex of the latest message	UINT8	RO	0x00 (0 _{dec})
10F3:03	Newest Acknowledged Message	Subindex of the last confirmed message	UINT8	RO	0x00 (0 _{dec})
10F3:04	New Message available	Indicates that a new message is available	BOOLEAN	RO	0x00 (0 _{dec})
10F3:05	Flags	not used	UINT16	RO	0x0000 (0 _{dec})
10F3:06	Diagnosis Message 001	Message 1	OCTET-STRING[28]	RO	{0}
...
10F3:37	Diagnosis Message 050	Message 50	OCTET-STRING[28]	RO	{0}

Index 10F8 Actual Time Stamp

Index (hex)	Name	Meaning	Data type	Flags	Default
10F8:0	Actual Time Stamp	Timestamp	UINT64	RO	

Index 9001 LIC Identity Data

Index (hex)	Name	Meaning	Data type	Flags	Default
9001:0	LIC Identity Data	Max. subindex	UINT8	RO	0x05 (5 _{dec})
9001:01	Public Key	reserved	OCTET-STRING[256]	RO	-
9001:02	Certificate	reserved	OCTET-STRING[256]	RO	-
9001:03	Public EK	reserved	OCTET-STRING[256]	RO	-
9001:04	Certificate EK	reserved	OCTET-STRING[256]	RO	-
9001:05	Volume Number	reserved	UINT32	RO	0x00000000 (0 _{dec})

Index 9002 LIC Session Data

Index (hex)	Name	Meaning	Data type	Flags	Default
9002:0	LIC Session Data	Max. Subindex	UINT8	RO	0x04 (4 _{dec})
9002:01	Signature	reserved	OCTET-STRING[256]	RO	{0}
9002:02	PCR Value	reserved	OCTET-STRING[20]	RO	{0}
9002:03	Tick Stamp	reserved	OCTET-STRING[256]	RO	{0}
9002:04	Current Ticks	reserved	OCTET-STRING[30]	RO	{0}

Index B008 LIC Control

Index (hex)	Name	Meaning	Data type	Flags	Default
B008:0	LIC Control	Max. Subindex	UINT8	RO	0x03 (3 _{dec})
B008:01	Control	reserved	UINT16	RW	0x0000 (0 _{dec})
B008:02	Status	reserved	UINT16	RO	0x0000 (0 _{dec})
B008:03	Challenge	reserved	OCTET-STRING[20]	RW	{0}

Index F900 LIC Time Data

Index (hex)	Name	Meaning	Data type	Flags	Default
F900:0	LIC Time Data	Max. subindex	UINT8	RO	0x01 (1 _{dec})
F900:01	Operating Time	Non-erasable operating hours counter [s]	UINT32	RO	0x00000000 (0 _{dec})

Index FB40 Memory interface

Index (hex)	Name	Meaning	Data type	Flags	Default
FB40:0	Memory interface	Maximum subindex	UINT8	RO	0x03 (3 _{dec})
FB40:01	Address	reserved	UINT32	RW	0x00000000 (0 _{dec})
FB40:02	Length	reserved	UINT16	RW	0x0000 (0 _{dec})
FB40:03	Data	reserved	OCTET-STRING[8]	RW	{0}

6.2.4 Standard objects (0x1000-0x1FFF)

The standard objects have the same meaning for all EtherCAT slaves.

Index 1000 Device type

Index (hex)	Name	Meaning	Data type	Flags	Default
1000:0	Device type	Device type of the EtherCAT slave: The Low-Word contains the CoE profile used (5001). The High-Word contains the module profile according to the modular device profile.	UINT32	RO	0x029E1389 (43914121 _{dec})

Index 1008 Device name

Index (hex)	Name	Meaning	Data type	Flags	Default
1008:0	Device name	Device name of the EtherCAT slave	STRING	RO	EJ6070

Index 1009 Hardware version

Index (hex)	Name	Meaning	Data type	Flags	Default
1009:0	Hardware version	Hardware version of the EtherCAT slave	STRING	RO	00

Index 100A Software version

Index (hex)	Name	Meaning	Data type	Flags	Default
100A:0	Software version	Firmware version of the EtherCAT slave	STRING	RO	01

Index 1018 Identity

Index (hex)	Name	Meaning	Data type	Flags	Default
1018:0	Identity	Information for identifying the slave	UINT8	RO	0x04 (4 _{dec})
1018:01	Vendor ID	Vendor ID of the EtherCAT slave	UINT32	RO	0x00000002 (2 _{dec})
1018:02	Product code	Product code of the EtherCAT slave	UINT32	RO	0x17B62852 (397813842 _{dec})
1018:03	Revision	Revision number of the EtherCAT slave; the Low Word (bit 0-15) indicates the special module number, the High Word (bit 16-31) refers to the device description	UINT32	RO	0x00000000 (0 _{dec})
1018:04	Serial number	Serial number of the EtherCAT slave; the Low Byte (bit 0-7) of the Low Word contains the year of production, the High Byte (bit 8-15) of the Low Word contains the week of production, the High Word (bit 16-31) is 0	UINT32	RO	0x00000000 (0 _{dec})

Index 1C00 Sync manager type

Index (hex)	Name	Meaning	Data type	Flags	Default
1C00:0	Sync manager type	Using the Sync Managers	UINT8	RO	0x02 (2 _{dec})
1C00:01	SubIndex 001	Sync-Manager Type Channel 1: Mailbox Write	UINT8	RO	0x01 (1 _{dec})
1C00:02	SubIndex 002	Sync-Manager Type Channel 2: Mailbox Read	UINT8	RO	0x02 (2 _{dec})

Index F000 Modular device profile

Index (hex)	Name	Meaning	Data type	Flags	Default
F000:0	Modular device profile	General information for the modular device profile	UINT8	RO	0x02 (2 _{dec})
F000:01	Module index distance	Index distance of the objects of the individual channels	UINT16	RO	0x0010 (16 _{dec})
F000:02	Maximum number of modules	Number of channels	UINT16	RO	0x0001 (1 _{dec})

Index F008 Code word

Index (hex)	Name	Meaning	Data type	Flags	Default
F008:0	Code word	reserved	UINT32	RW	0x00000000 (0 _{dec})

Index F010 Module list

Index (hex)	Name	Meaning	Data type	Flags	Default
F010:0	Module list	Length of this object	UINT8	RW	0x01 (1 _{dec})
F010:01	SubIndex 001	Revision	UINT32	RW	0x0000029E (670 _{dec})

7 Appendix

7.1 Support and Service

Beckhoff and their partners around the world offer comprehensive support and service, making available fast and competent assistance with all questions related to Beckhoff products and system solutions.

Beckhoff's branch offices and representatives

Please contact your Beckhoff branch office or representative for local support and service on Beckhoff products!

The addresses of Beckhoff's branch offices and representatives round the world can be found on her internet pages: <https://www.beckhoff.com>

You will also find further documentation for Beckhoff components there.

Beckhoff Support

Support offers you comprehensive technical assistance, helping you not only with the application of individual Beckhoff products, but also with other, wide-ranging services:

- support
- design, programming and commissioning of complex automation systems
- and extensive training program for Beckhoff system components

Hotline: +49 5246 963 157
Fax: +49 5246 963 9157
e-mail: support@beckhoff.com

Beckhoff Service

The Beckhoff Service Center supports you in all matters of after-sales service:

- on-site service
- repair service
- spare parts service
- hotline service

Hotline: +49 5246 963 460
Fax: +49 5246 963 479
e-mail: service@beckhoff.com

Beckhoff Headquarters

Beckhoff Automation GmbH & Co. KG

Huelshorstweg 20
33415 Verl
Germany

Phone: +49 5246 963 0
Fax: +49 5246 963 198
e-mail: info@beckhoff.com
web: <https://www.beckhoff.com>

More Information:
www.beckhoff.com/EJ6070

Beckhoff Automation GmbH & Co. KG
Hülshorstweg 20
33415 Verl
Germany
Phone: +49 5246 9630
info@beckhoff.com
www.beckhoff.com

