

Operating manual | EN

EPX3158-0022

Eight channel, analog EtherCAT Box, 4...20 mA, single-ended, 16 bit, Ex i



Table of contents

1 Foreword	5
1.1 Notes on the documentation	5
1.2 Safety instructions	6
1.3 Documentation issue status	7
1.4 Marking of EPX modules.....	8
2 Product overview	10
2.1 EPX3158-0022 - Introduction	10
2.2 EPX3158-0022 - Technical data	11
2.3 Intended use	13
3 Mounting and connection	14
3.1 Special conditions for EPX EtherCAT Box modules	14
3.2 Installation notes for EPX EtherCAT Box Modules	14
3.3 Mounting	16
3.3.1 Dimensions	16
3.3.2 Mounting	17
3.3.3 Functional earth (FE)	17
3.3.4 Disposal	17
3.4 Connection	18
3.4.1 Connector.....	18
3.4.2 EtherCAT	19
3.4.3 Power supply.....	21
3.4.4 Shielding and potential separation	22
3.4.5 Signal inputs.....	23
4 Basic function principles	24
4.1 EtherCAT basics	24
4.2 Notices on analog specifications	24
4.2.1 Full scale value (FSV).....	24
4.2.2 Measuring error/ measurement deviation	25
4.2.3 Temperature coefficient tK [ppm/K].....	25
4.2.4 Single-ended/differential typification	27
4.2.5 Common-mode voltage and reference ground (based on differential inputs).....	30
4.2.6 Dielectric strength	30
4.2.7 Temporal aspects of analog/digital conversion	31
4.3 NAMUR basic information.....	34
5 Parameterization and programming	35
5.1 Integrating into a TwinCAT project.....	35
5.2 TwinCAT Development Environment.....	35
5.2.1 Installation of the TwinCAT real-time driver	36
5.2.2 Notes regarding ESI device description	41
5.2.3 TwinCAT ESI Updater.....	45
5.2.4 Distinction between Online and Offline	45
5.2.5 OFFLINE configuration creation.....	46
5.2.6 ONLINE configuration creation	51

5.2.7	EtherCAT subscriber configuration	59
5.3	Process data and operation modes	68
5.3.1	Parameterization	68
5.3.2	Settings and operating modes	69
5.3.3	Process data	74
5.3.4	Data stream and measurement ranges.....	79
5.4	CoE object description and parameterization	83
5.4.1	Restore object	83
5.4.2	Configuration data	84
5.4.3	Input data	85
5.4.4	Output data	85
5.4.5	Standard objects	85
6	Appendix	90
6.1	EtherCAT AL Status Codes	90
6.2	UL notice	90
6.3	Support and Service.....	91

1 Foreword

1.1 Notes on the documentation

Intended audience

This description is only intended for the use of trained specialists in control and automation engineering who are familiar with the applicable national standards.

It is essential that the documentation and the following notes and explanations are followed when installing and commissioning these components.

It is the duty of the technical personnel to use the documentation published at the respective time of each installation and commissioning.

The responsible staff must ensure that the application or use of the products described satisfy all the requirements for safety, including all the relevant laws, regulations, guidelines and standards.

Disclaimer

The documentation has been prepared with care. The products described are, however, constantly under development.

We reserve the right to revise and change the documentation at any time and without prior announcement.

No claims for the modification of products that have already been supplied may be made on the basis of the data, diagrams and descriptions in this documentation.

Trademarks

Beckhoff®, TwinCAT®, TwinCAT/BSD®, TC/BSD®, EtherCAT®, EtherCAT G®, EtherCAT G10®, EtherCAT P®, Safety over EtherCAT®, TwinSAFE®, XFC®, XTS® and XPlanar® are registered trademarks of and licensed by Beckhoff Automation GmbH. Other designations used in this publication may be trademarks whose use by third parties for their own purposes could violate the rights of the owners.

Patent Pending

The EtherCAT Technology is covered, including but not limited to the following patent applications and patents: EP1590927, EP1789857, EP1456722, EP2137893, DE102015105702 with corresponding applications or registrations in various other countries.



EtherCAT® is registered trademark and patented technology, licensed by Beckhoff Automation GmbH, Germany.

Copyright

© Beckhoff Automation GmbH & Co. KG, Germany.

The reproduction, distribution and utilization of this document as well as the communication of its contents to others without express authorization are prohibited.

Offenders will be held liable for the payment of damages. All rights reserved in the event of the grant of a patent, utility model or design.

1.2 Safety instructions

Safety regulations

Please note the following safety instructions and explanations!
Product-specific safety instructions can be found on following pages or in the areas mounting, wiring, commissioning etc.

Exclusion of liability

All the components are supplied in particular hardware and software configurations appropriate for the application. Modifications to hardware or software configurations other than those described in the documentation are not permitted, and nullify the liability of Beckhoff Automation GmbH & Co. KG.

Personnel qualification

This description is only intended for trained specialists in control, automation and drive engineering who are familiar with the applicable national standards.

Description of instructions

In this documentation the following instructions are used.
These instructions must be read carefully and followed without fail!

DANGER

Serious risk of injury!

Failure to follow this safety instruction directly endangers the life and health of persons.

WARNING

Risk of injury!

Failure to follow this safety instruction endangers the life and health of persons.

CAUTION

Personal injuries!

Failure to follow this safety instruction can lead to injuries to persons.

NOTE

Damage to environment/equipment or data loss

Failure to follow this instruction can lead to environmental damage, equipment damage or data loss.



Tip or pointer

This symbol indicates information that contributes to better understanding.

1.3 Documentation issue status

Version	Comment
1.1.0	<ul style="list-style-type: none">• Chapter <i>Basic function principles</i> added• Chapter <i>Parameterization and programming</i> added
1.0.0	<ul style="list-style-type: none">• Ex marking and name plates updated• Certificate numbers updated• Chapter <i>Special conditions for EPX EtherCAT Box Modules</i> updated
0.3	<ul style="list-style-type: none">• Chapter <i>Marking of EPX modules</i> updated• Technical data updated• Chapter <i>Mounting and connection</i> updated
0.2	<ul style="list-style-type: none">• Product images updated• Chapter <i>Marking of EPX modules</i> updated• Technical data updated• New title page
0.1	<ul style="list-style-type: none">• First draft

1.4 Marking of EPX modules

Name

An EPX EtherCAT Box has a 15-digit technical designation, composed of

- Family key
- Type
- Version
- Revision

Example	Family	Type	Version	Revision
EPX1058-0022-0001	EPX EtherCAT Box	1058: 8-channel digital EtherCAT Box for NAMUR sensors, Ex i	0022: 60 mm width, M12	0001

Notes

- the elements mentioned above result in the **technical designation**. EPX1058-0022-0001 is used in the example below.
- "EPX1058-0022" is the order identifier, "0001" is the EtherCAT revision.
- The **order identifier** is composed of
 - family key (EPX)
 - type (1058)
 - version (0022)
- The **revision** 0001 reflects the technical progress such as feature enhancement with regard to EtherCAT communication and is managed by Beckhoff.
In principle, a device with a higher revision can replace a device with a lower revision, unless otherwise specified, e.g. in the documentation.
Associated and synonymous with each revision there is usually a description (ESI, EtherCAT Slave Information) in the form of an XML file, which is available for download from the Beckhoff website.
The revision is applied to the modules on the outside, see Fig. *EPX1058 with date code 3218FMFM, BTN 10000100 and Ex marking*.
- The type, version and revision are read as decimal numbers, even if they are technically saved in hexadecimal.

Identification numbers

EPX modules have two different identification numbers:

- date code (batch number)
- **Beckhoff Traceability Number**, or BTN for short (as a serial number it clearly identifies each module)

Date code

The date code is an eight-digit number given by Beckhoff and printed on the EPX module. The date code indicates the build version in the delivery state and thus identifies an entire production batch but does not distinguish between the modules in a batch.

Structure of the date code: **WW YY FF HH**
 WW - week of production (calendar week)
 YY - year of production
 FF - firmware version
 HH - hardware version

Example with date code 02180100:
 02 - week of production 02
 18 - year of production 2018
 01 - firmware version 01
 00 - hardware version 00

Beckhoff Traceability Number (BTN)

In addition, each EPX EtherCAT Box has a unique **Beckhoff Traceability Number (BTN)**.

Ex marking

In the center of the labeling you will find the Ex marking:

II 3 (1) G Ex ec [ia Ga] IIC T4 Gc
 II 3 (1) D Ex tc [ia Da] IIIC T135°C Dc
 I (M1) [Ex ia Ma] I
 IECEx BVS 22.0043X
 BVS 22 ATEX E 047 X
 Ta: -25 ... +70 °C

Examples



Fig. 1: Side name plate of EPX1058-0022, EPX3158-0022 and EPX3184-0022

2 Product overview

2.1 EPX3158-0022 - Introduction

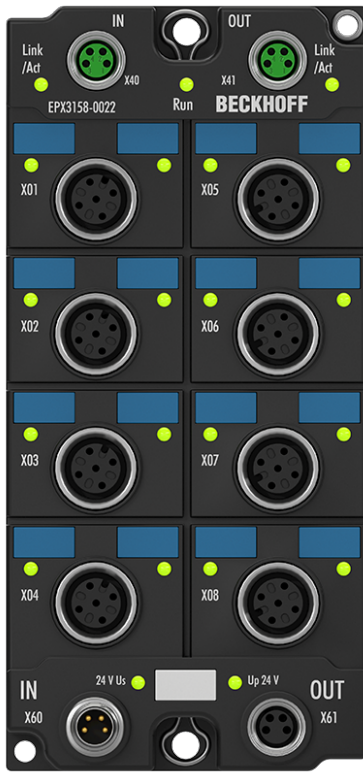

Fig. 2: EPX3158-0022 - 8-channel analog EtherCAT Box, 4...20 mA, single-ended, 16 bit, Ex i

The EPX3158-0022 analog EtherCAT Box allows the direct connection of intrinsically safe field devices from hazardous areas of zones 0/20 and 1/21. It supplies measuring transducers located in the field and transmits their analog measuring signals electrically isolated to the automation device. With a technical measuring range of 107 % of the nominal range, the EtherCAT Box also supports commissioning with sensor values in the limit range and the evaluation according to NAMUR NE43. The error LEDs indicate an overload condition and wire break.

2.2 EPX3158-0022 - Technical data

EtherCAT		EPX3158-0022
Connection		2x M8 socket, 4-pin, green

Supply voltage		EPX3158-0022
Connection	Input	M8 connector, 4-pin, black
	Downstream connection	M8 socket, 4-pin, black
U _S nominal voltage		24 V _{DC} (-15 % / +20 %)
U _S current consumption		typically 50 mA
U _S sum current: I _{S,SUM}		max. 4 A at 55 °C, max. 2.5 A at 70 °C, linear in between
U _P nominal voltage		24 V _{DC} (-15 % / +20 %)
U _P current consumption		typically 15 mA + load
U _P sum current: I _{P,SUM}		max. 4 A at 55 °C, max. 2.5 A at 70 °C, linear in between

Analog inputs		EPX3158-0022
Technology		intrinsically safe sensors
Number of inputs		8 (single-ended)
Connection		8 x M12 socket, 2-/3-wire
Nominal voltage		24 V _{DC}
Signal current		4 ... 20 mA
Technical measuring range		107 %*
Internal resistance		typ. 100 Ω
Input filter cut-off frequency		5 kHz
Conversion time		typ. 1 ms
Resolution		16 bit (including sign)
Measuring error		< ± 0.3 % (relative to full scale value)
Distributed Clocks		yes
Bit width in the process image	Standard PDO	8 x 4 bytes (default)
	Compact PDO	8 x 2 bytes
Configuration		No address or configuration settings required
Special features		- Standard and compact process image - activatable FIR/IIR filters - limit value monitoring - NE43 NAMUR

*) With a technical measuring range of 107 % of the nominal range, the EtherCAT Box also supports commissioning with sensor values in the limit range and the evaluation according to NAMUR NE43.

Housing data		EPX3158-0022
Dimensions (W x H x D)		60 mm x 150 mm x 26.5 mm
Weight		approx. 250 g
Installation position		variable
Material		PA6 (polyamide)

Environmental conditions	EPX3158-0022
Permissible ambient temperature range during operation	-25 °C ... +70 °C
Permissible ambient temperature range during storage	-40 °C ... +85 °C
Mounting	Stand-alone / on optional mounting rail
Vibration / shock resistance	conforms to EN 60068-2-6 / EN 60068-2-27
EMC immunity / emission	conforms to EN 61000-6-2 / EN 61000-6-4
Protection rating	IP65, IP66, IP67 (according to EN 60529)

Approvals	EPX3158-0022
Approvals / markings*	CE, UL, ATEX, IECEx

*) Real applicable approvals/markings see type plate on the side (product marking).

Technical data for explosion protection	EPX3158-0022		
Ex marking	II 3 (1) G Ex ec [ia Ga] IIC T4 Gc II 3 (1) D Ex tc [ia Da] IIIC T135°C Dc I (M1) [Ex ia Ma] I		
Certificate numbers	IECEx BVS 22.0043X BVS 22 ATEX E 047 X		
Power supply	Via U_s and U_p $U_m = 60 V_{DC}$		
Field interfaces	$U_o = 27 V$ $I_o = 80 mA$ $P_o = 540 mW$ Characteristic curve: linear		
Reactances (without consideration of simultaneity)		L_o	C_o
	Ex ia I	49 mH	3.75 μF
	Ex ia IIA	35 mH	2.33 μF
	Ex ia IIB	21 mH	705 nF
	Ex ia IIC	2.8 mH	90 nF
	Ex ia IIIC	21 mH	705 nF

2.3 Intended use

WARNING

Danger to the safety of persons and equipment!

EPX components may only be used for the purposes described below!

CAUTION

Observe ATEX and IECEx!

The EPX components may only be used in accordance with the ATEX directive and the IECEx scheme!

The EPX EtherCAT Box modules extend the field of application of the EtherCAT system by functions for the integration of intrinsically safe field devices from hazardous areas. The intended field of application are data acquisition and control tasks in discrete and process automation, taking explosion protection requirements into consideration.

The EPX EtherCAT Box modules are protected by the ignition protection type "Increased safety" (Ex e) according to IEC 60079-7 as well as "Protection by enclosure" (Ex t) according to IEC60079-31 and may only be operated in hazardous areas of zone 2/22 or in non-hazardous areas.

The field interfaces of the EPX EtherCAT Box modules achieve explosion protection by means of the "Intrinsic safety" (Ex i) ignition protection type in accordance with IEC 60079-11. Therefore, only appropriately certified, intrinsically safe devices may be connected to EPX EtherCAT Box modules. Observe the maximum permissible connected load values in terms of voltages, currents and reactances. Any instances of non-compliance may damage the EPX EtherCAT Box modules and thus render the explosion protection ineffective.

CAUTION

Ensure traceability!

The buyer has to ensure the traceability of the device via the Beckhoff Traceability Number (BTN).

3 Mounting and connection

3.1 Special conditions for EPX EtherCAT Box modules

⚠ WARNING

Observe the special conditions for the intended use of Beckhoff EPX EtherCAT Box modules in hazardous areas (ATEX Directive 2014/34/EU)!

- The connection points are to be protected by a modification in such a way that a protection against mechanical danger is guaranteed!
- If the temperatures during nominal operation are higher than 70 °C at the feed-in points of cables, lines or pipes, or higher than 80 °C at the wire branching points, then cables must be selected whose temperature data correspond to the actual measured temperature values!
- When using EPX EtherCAT Box modules in hazardous areas, observe the permissible ambient temperature range of -25 to +70 °C!
- Measures must be taken to protect against the nominal operating voltage being exceeded by more than 40% due to short-term interference voltages! The power supply of the EPX EtherCAT Box must comply with overvoltage category II according to EN 60664-1.
- SELV/PELV circuits (Safety Extra Low Voltage, Protective Extra Low Voltage) with a maximum error voltage of 60 V_{DC} must be used to supply the EPX EtherCAT Box modules!
- The power and EtherCAT connectors of the certified components may only be connected or disconnected when the supply voltage has been switched off or when a non-explosive atmosphere is ensured!
- The EPX EtherCAT Box modules must be protected from direct sunlight.

3.2 Installation notes for EPX EtherCAT Box Modules

NOTE

Storage, transport and mounting

- Transport and storage are permitted only in the original packaging!
- Store in a dry place, free from vibrations.
- A brand new EPX EtherCAT Box with a certified build version is delivered only in a sealed carton. Therefore, check that the carton and all seals are intact before unpacking.
- Do not use the EPX EtherCAT Box if
 - its packaging is damaged
 - the terminal is visibly damaged or
 - you cannot be sure of the origin of the terminal.
- EPX EtherCAT Box Modules with a damaged packaging seal are regarded as used.

⚠ WARNING

Observe the accident prevention regulations

During mounting, commissioning, operation and maintenance, adhere to the safety regulations, accident prevention regulations and general technical rules applicable to your devices, machines and plants.

⚠ CAUTION

Observe the erection regulations

Observe the applicable erection regulations.

NOTE**Handling**

- The opening of the housing, the removal of parts and any mechanical deformation or machining of an EPX EtherCAT Box are not permitted!

If an EPX EtherCAT Box is defective or damaged it must be replaced by an equivalent terminal. Do not carry out any repairs to the devices. For safety reasons repairs may only be carried out by the manufacturer.

NOTE**Contact labeling and pin assignment**

The colored labels above the front connection contacts shown in the illustrations of the introductory chapter are only exemplary and not part of the scope of delivery!

A clear assignment of channel and connection designation according to the chapter [Connection \[► 18\]](#) to the actual connection contact can be made via the designations on the respective connector as well as via the [name plate \[► 9\]](#).

Observe the polarity dependency of connected intrinsically safe circuits, if applicable!

⚠ WARNING**Observe the minimum distances according to IEC 60079-14!**

Also observe the specified minimum distances between intrinsically safe and non-intrinsically safe circuits according to IEC 60079-14!

3.3 Mounting

⚠ WARNING

Risk of injury through electric shock and damage to the device!

Bring the system in a safe, de-energized state before you start mounting, dismantling or wiring the EPX EtherCAT Box modules!

3.3.1 Dimensions

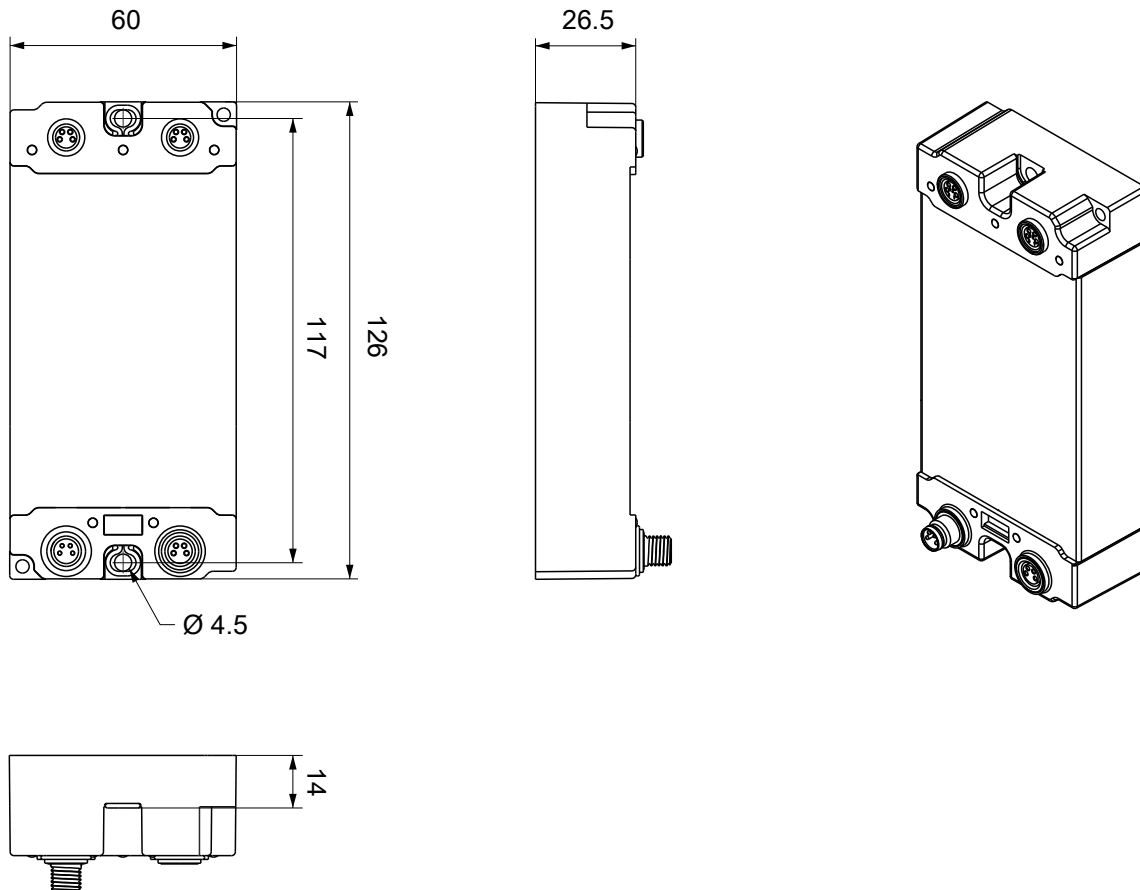

Fig. 3: EPX EtherCAT Box - Dimensions

All dimensions are given in millimeters.
The drawing is not true to scale.

Housing features

Housing material	PA6 (polyamide)
Sealing compound	Polyurethane
Mounting	two mounting holes Ø 4.5 mm for M4
Metal parts	brass, nickel-plated
Contacts	CuZn, gold-plated
Installation position	variable
Protection rating	IP65, IP66, IP67 (conforms to EN 60529) when screwed together
Dimensions (H x W x D)	approx. 126 x 60 x 26.5 mm (without connectors)

3.3.2 Mounting

NOTE
<p>Protect connections against dirt!</p> <p>Protect all connections from contamination during module installation! Protection rating IP67 can only be guaranteed if all cables and connectors are connected!</p> <ul style="list-style-type: none"> • Protect the connectors against dirt during the assembly.

Mount the module with two M4 screws in the centrally located mounting holes.

Note when mounting that the overall height is increased further by the fieldbus connections. See chapter Accessories.

Mounting Rail ZS5300-0011

The mounting rail ZS5300-0011 (500 mm x 129 mm) has in addition to the M3 threads also pre-made M4 threads to fix 60 mm wide modules via their middle holes.

Up to 14 narrow or 7 wide modules may be mixed mounted.

3.3.3 Functional earth (FE)

EPX EtherCAT Box modules must be grounded.

The Fixing also serve as connections for the functional earth (FE).

Make sure that the box is earthed with low impedance via both fastening screws. You can achieve this, for example, by mounting the box on a grounded machine bed.

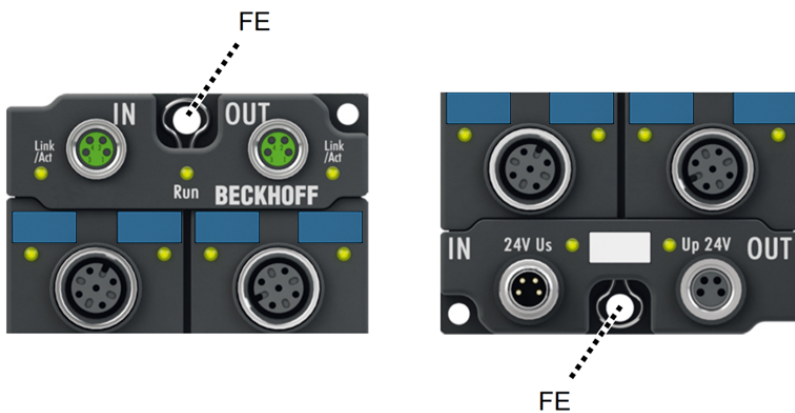

Fig. 4: EPX EtherCAT Box - Functional earth via the fastening holes

3.3.4 Disposal



Products marked with a crossed-out wheeled bin shall not be discarded with the normal waste stream. The device is considered as waste electrical and electronic equipment. The national regulations for the disposal of waste electrical and electronic equipment must be observed.

3.4 Connection

⚠ WARNING

Risk of injury through electric shock and damage to the device!

Bring the system in a safe, de-energized state before you start mounting, dismantling or wiring the EPX EtherCAT Box modules!

3.4.1 Connector

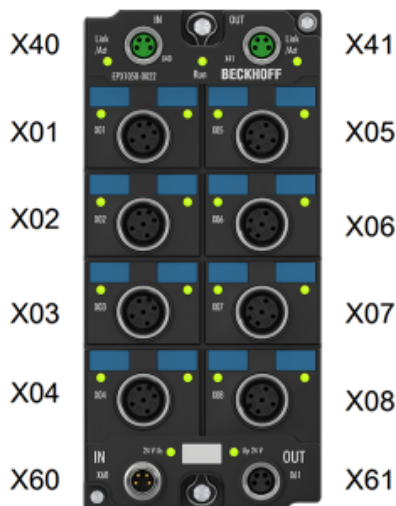

Fig. 5: Connectors using EPX1058-0022 as an example

Name	Function	Connector type	Tightening torque*
X01	Signal inputs	M12 socket	0.6 Nm
X02			
X03			
X04			
X05			
X06			
X07			
X08			
X40	EtherCAT: input	M8 socket	0.4 Nm
X41	EtherCAT: downstream connection		
X60	Supply voltage: input	M8 connector	0.4 Nm
X61	Supply voltage: downstream connection	M8 socket	

⚠ WARNING

Use torque wrench!

The specified tightening torque must be observed in order to be allowed to use the product in the hazardous area!

- Mount plugs and protective caps on these connectors with a torque wrench; e.g. Beckhoff ZB8801.
- Ensure the correct seating and tightening torque of pre-assembled protective caps. Protective caps are pre-assembled at the factory to protect connectors during transport. They may not be tightened enough to meet the conditions for hazardous area and protection rating IP67.
- Also seal unused connectors with protective caps!

3.4.2 EtherCAT

3.4.2.1 EtherCAT - connector

NOTE
<p>Danger of confusion: EtherCAT and supply voltages</p> <p>Defect possible due to mismatching of M8 connectors!</p> <ul style="list-style-type: none"> • green: EtherCAT • black: supply voltages

EtherCAT Box Modules have two green M8 sockets for the incoming and downstream EtherCAT connections.



Fig. 6: EtherCAT connector

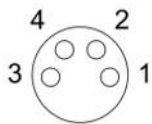

Fig. 7: EtherCAT connector - pin assignment

EtherCAT	M8 connector	Core colors		
Signal	Contact	ZB9010, ZB9020, ZB9030, ZB9032, ZK1090-6292, ZK1090-3xxx-xxxx	ZB9031 and old versions of ZB9030, ZB9032, ZK1090-3xxx-xxxx	TIA-568B
Tx+	1	yellow*	white/orange	white/orange
Tx-	4	orange*	orange	orange
Rx+	2	white*	white/blue	white/green
Rx-	3	blue*	blue	green
Shield	Housing	Shield	Shield	Shield

*) Core colors according to EN 61918

i Adaptation of core colors for cables ZB9030, ZB9032, ZK1090-3xxxx-xxxx

For standardization, the core colors of the ZB9030, ZB9032 and ZK1090-3xxx-xxxx cables have been changed to the EN 61918 core colors: yellow, orange, white, blue. So there are different color codes in circulation. The electrical properties of the cables have been retained when the core colors were changed

3.4.2.2 EtherCAT - status LEDs



Fig. 8: EtherCAT - status LEDs

Link/Act (L/A)

A green LED labelled **Link/Act** is located next to each EtherCAT socket. The LED indicates the communication state of the respective socket.

LED Link/Act	Meaning
off	no connection to the connected EtherCAT device
lit	LINK: connection to the connected EtherCAT device
flashes	ACT: communication with the connected EtherCAT device

Run

Each EtherCAT device has a green LED labeled **Run**. The LED signals the status of the device in the EtherCAT network.

LED Run	Meaning
off	Device is in "Init" state
flashes uniformly	Device is in "Pre-Operational" state
flashes sporadically	Device is in "Safe-Operational" state
lit	Device is in "Operational" state

NOTE



EtherCAT system documentation

For further information on EtherCAT states etc. please refer to the [EtherCAT system documentation](#), which is also available from the Beckhoff homepage on the [product page](#) of your EtherCAT device under *Documentation and Downloads / Technical Documentation*.

3.4.2.3 EtherCAT - cables

For the connection of EtherCAT devices use shielded Ethernet cables which at least comply with category 5 (CAT5) according to EN 50173 or ISO/IEC 11801.

EtherCAT uses four wires for signal transmission. Thanks to automatic line detection ("Auto MDI-X"), both symmetrical (1:1) or cross-over cables can be used between Beckhoff EtherCAT devices.

NOTE



Infrastructure for EtherCAT/Ethernet Technical recommendations and notes for design, implementation and testing

For further information on EtherCAT cables etc. please refer to the documentation [Infrastructure for EtherCAT/Ethernet](#), which is also available from the Beckhoff homepage on the [product page](#) of your EtherCAT device under *Documentation and Downloads / Technical Documentation*.

3.4.3 Power supply

3.4.3.1 Power supply - connector

NOTE
<p>Danger of confusion: EtherCAT and supply voltages</p> <p>Defect possible due to mismatching of M8 connectors!</p> <ul style="list-style-type: none"> • green: EtherCAT • black: supply voltages

The EtherCAT Box is supplied with two supply voltages. The ground potentials of the supply voltages are electrically isolated.

- Control voltage U_s
- Peripheral voltage U_p



Fig. 9: Power supply connector - input (left), downstream connection (right)



Fig. 10: Connector of the power supply - pin assignment

Contact	Function	Description	Core color*
1	U_s	Control voltage	brown
2	U_p	Peripheral voltage	white
3	GND_s	GND to U_s	blue
4	GND_p	GND to U_p	black

*) The core colors apply to cables of type: Beckhoff ZK2020-3xxx-xxxx

3.4.3.2 Power supply - status LEDs



Fig. 11: Status LEDs for the supply voltages

LED	Display	Meaning
U _s (control voltage)	off	Supply voltage U _s is not present
	green illuminated	Supply voltage U _s is present
U _p (peripheral voltage)	off	Supply voltage U _p is not present
	green illuminated	Supply voltage U _p is present

3.4.3.3 Conductor losses

Take into account the voltage drop on the supply line when planning a system. Avoid the voltage drop being so high that the supply voltages at the box lies below the minimum nominal voltage.

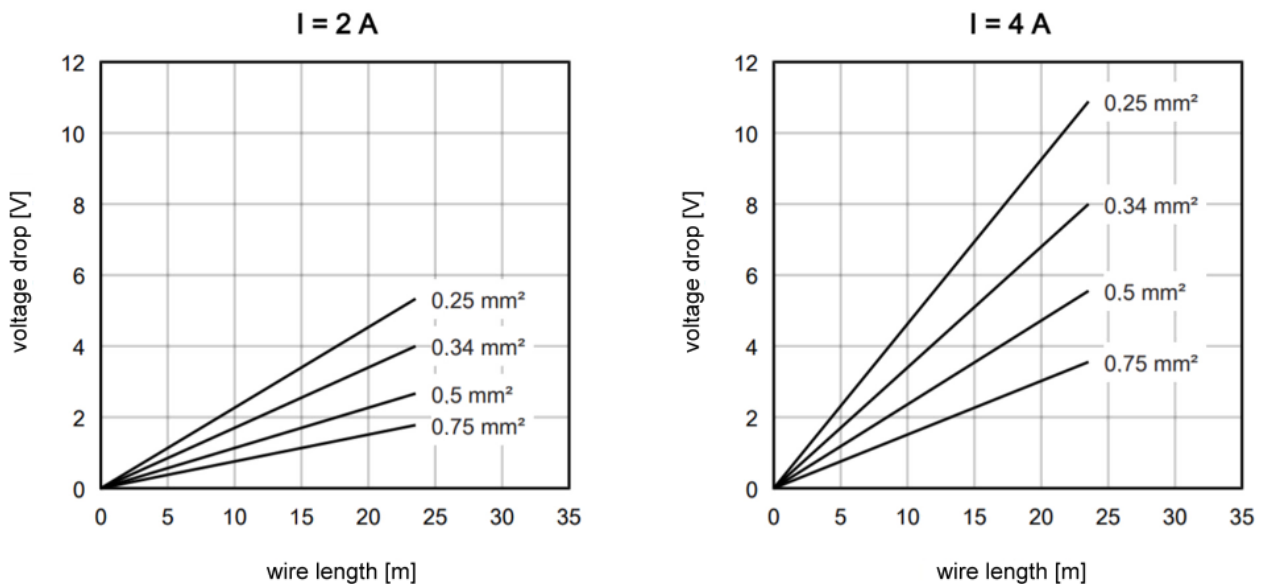

Fig. 12: Voltage drop on the supply line

Voltage fluctuations of the power supply unit must also be taken into account.

3.4.4 Shielding and potential separation



Shielding

Encoder, analog sensors and actors should always be connected with shielded, twisted paired wires!

⚠ CAUTION

Observe installation requirements in areas of potentially explosive atmospheres!

During installation, observe the requirements for cables, shielding and earth potential equalization in areas of potentially explosive atmospheres according to IEC 60079-11, IEC 60079-14 and IEC 60079-25!

3.4.5 Signal inputs

3.4.5.1 Signal inputs - connectors

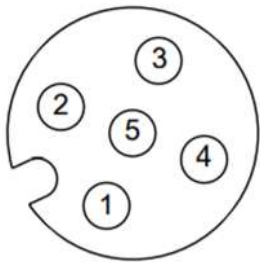

Fig. 13: M12 connector of the inputs - pin assignment

Contact (pin)	Symbol	Description
1	U_{V,n^*}	Sensor power supply for channel n^*
2	Input n^*	Input channel n^*
3	GND n^*	Ground for channel $n^1)$ (for 3-wire connection)
4	-	reserved
5	-	reserved

*) n applies to channel 1 ... 8

⚠ WARNING

The reserved contacts (pins) of the connections must not be connected or grounded!

- Do not connect any signals, voltages or ground potential to the reserved contacts!
- Pre-assembled connection cables that have the cable shield connected to pin 5 must not be used with the EtherCAT EPX Box modules!

3.4.5.2 LED displays

The EPX3158-0022 EtherCAT Box has a signal LED for each channel that can signal an error. The following tables are for the respective LED number of a channel.



Fig. 14: EPX3158 - signal LEDs

LED display

LED	Color	Meaning
Error	red	Error indication in case of wire break or if the measuring range is exceeded or not reached.

4 Basic function principles

4.1 EtherCAT basics

For basic information about the EtherCAT fieldbus please refer to the [EtherCAT system documentation](#), which is also available as [PDF file](#) at www.beckhoff.com in the download area of your EtherCAT device.

4.2 Notices on analog specifications

Beckhoff I/O devices (terminals, boxes, modules) with analog inputs are characterized by a number of technical characteristic data; refer to the technical data in the respective documents.

Some explanations are given below for the correct interpretation of these characteristic data.

4.2.1 Full scale value (FSV)

An I/O device with analog input measures over a nominal measuring range, which is limited by an upper and a lower limit (start value and end value), which can usually already be taken from the device designation. The range between both limits is called measuring span and corresponds to the formula (end value - start value). Analogous to pointing devices this is the measuring scale (see IEC 61131) or also the dynamic range.

For analog I/O devices from Beckhoff, the full scale value (FSV) of the respective product (also: reference value) is selected as the largest limit of the nominal measuring range and is given a positive sign. This applies to both symmetrical and asymmetrical measuring spans.

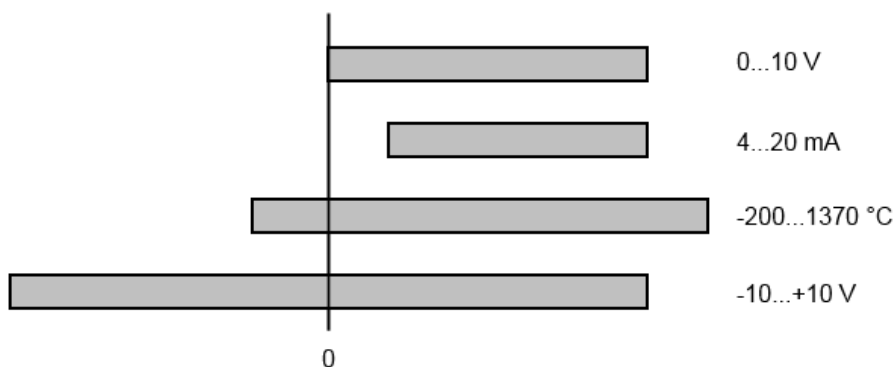

Fig. 15: Full scale value, measuring span

For the above **examples** this means:

- Measuring range 0...10 V: asymmetric unipolar, FSV = 10 V, measuring span = 10 V
- Measuring range 4...20 mA: asymmetric unipolar, FSV = 20 mA, measuring span = 16 mA
- Measuring range -200...1370 °C: asymmetric bipolar, FSV = 1370 °C, measuring span = 1570 °C
- Measuring range -10...+10 V: symmetric bipolar, FSV = 10 V, measuring span = 20 V

Depending on the functionality, an analog input channel may have a technical measuring range that exceeds the nominal measuring range, e.g. to gain more diagnostic information about the signal.

The case-by-case information in the device documentation on the behavior outside the nominal measuring range (measurement uncertainty, display value) must be observed.

The above thoughts are correspondingly applicable to analog output devices:

- The full scale value (FSV) becomes the output end value
- Here, too, there can be a (larger) technical output range in addition to the nominal output range

4.2.2 Measuring error/ measurement deviation

● Analog output

The following information also applies analogously to the output end value of analog output devices.

The relative measuring error as a specification value of a Beckhoff analog device is specified in % of the nominal FSV (output end value) and calculated as the quotient of the numerically largest probable deviation from the true measured value (output value) with respect to the FSV (output end value):

$$\text{Measuring error} = \frac{\left| \text{max. deviation} \right|}{\text{full scale value}}$$

It should be noted here that the "true measured value" cannot be determined with infinite accuracy either, but can only be determined via reference devices with a higher expenditure of technology and measuring time and thus a significantly lower measurement uncertainty.

The value therefore describes the result window in which the measured value determined by the device under consideration (Beckhoff analog device) lies with a very high probability in relation to the "true value". Thus, colloquially, this is a "typical" value (typ.); this expresses that the vast statistical majority of values will be within the specification window, but in rare cases there may/will be deviations outside the window.

For this reason, the term "measurement uncertainty" has become established for this window, since "error" is now used to refer to known disturbance effects that can generally be systematically eliminated.

The uncertainty of measurement must always be considered in relation to potential environmental influences:

- invariable electrical channel properties such as temperature sensitivity,
- variable settings of the channel (noise via filters, sampling rate, ...).

Measurement uncertainty specifications without further operational limitation (also called "service error limit") can be assumed as a value "over everything": entire permissible operating temperature range, default setting, etc.

The window is always to be understood as a positive/negative span with "±", even if occasionally indicated as a "half" window without "±".

The maximum deviation can also be specified directly.

Example: measuring range 0...10 V (FSV = 10 V) and measurement uncertainty $< \pm 0.3\%_{\text{FSV}}$ → the expected maximum usual deviation is ± 30 mV in the permissible operating temperature range.

● Lower measurement uncertainty possible

If this specification also includes the temperature drift, a significantly lower measuring error can usually be assumed in case of a constant ambient temperature of the device and thermal stabilization after a user calibration.

4.2.3 Temperature coefficient tK [ppm/K]

An electronic circuit is usually temperature dependent to a greater or lesser degree. In analog measurement technology this means that when a measured value is determined by means of an electronic circuit, its deviation from the "true" value is reproducibly dependent on the ambient/operating temperature.

A manufacturer can alleviate this by using components of a higher quality or by software means.

The temperature coefficient, when indicated, specified by Beckhoff allows the user to calculate the expected measuring error outside the basic accuracy. The basic accuracy is usually specified for 23 °C ambient temperature, in special cases also at other temperature.

Due to the extensive uncertainty considerations that are incorporated in the determination of the basic accuracy, Beckhoff recommends a quadratic summation.

Example: Let the basic accuracy be $\pm 0.01\%$ typ. (full scale value), $tK = 20$ ppm/K typ at $23\text{ }^{\circ}\text{C}$.; the accuracy A35 at $35\text{ }^{\circ}\text{C}$ is wanted, hence $\Delta T = 12\text{ K}$:

$$G35 = \sqrt{(0.01\%)^2 + (12\text{K} \cdot 20 \frac{\text{ppm}}{\text{K}})^2} = 0.026\% \text{ full scale value, typ.}$$

Remarks: ppm $\triangleq 10^{-6}$ % $\triangleq 10^{-2}$

4.2.4 Single-ended/differential typification

For analog inputs Beckhoff makes a basic distinction between two types: *single-ended* (SE) and *differential* (DIFF), referring to the difference in electrical connection with regard to the potential difference.

The diagram shows two-channel versions of an SE module and a DIFF module as examples for all multi-channel versions.

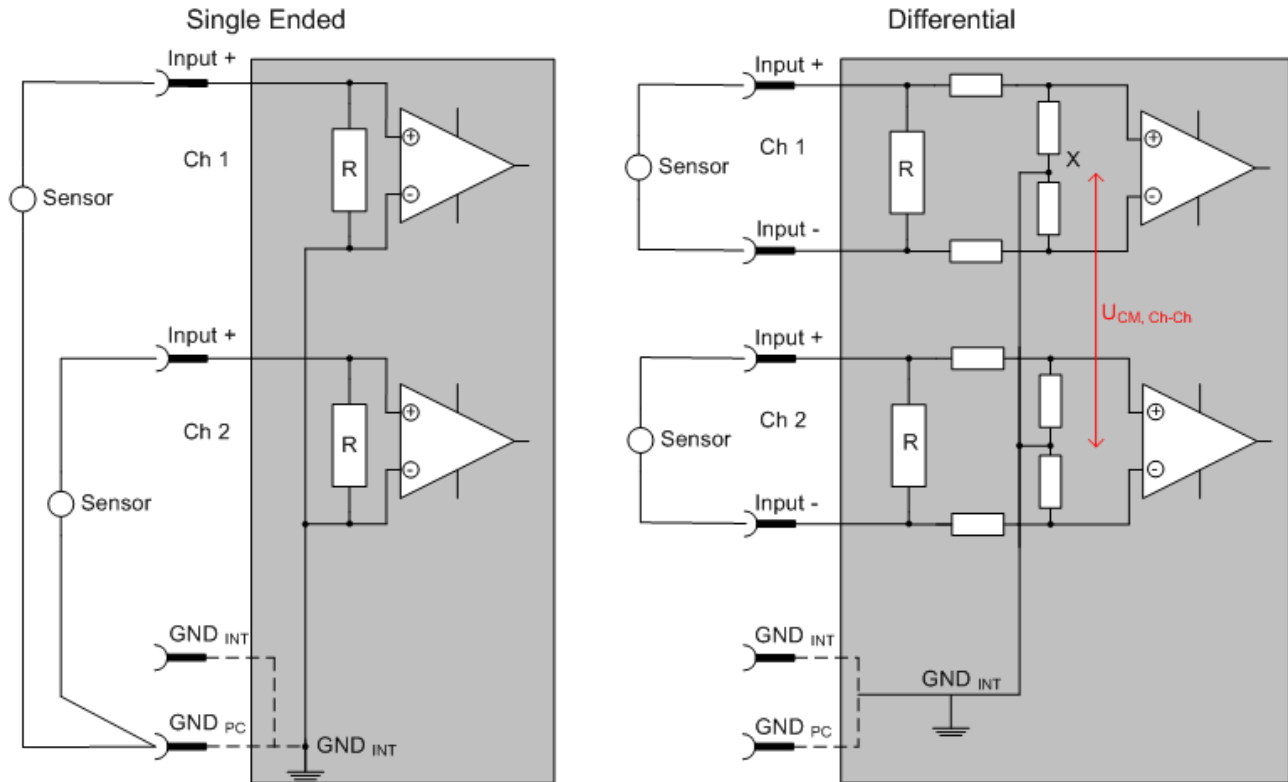

Fig. 16: SE and DIFF module as 2-channel version

Note: Dashed lines indicate that the respective connection may not necessarily be present in each SE or DIFF module. Electrical isolated channels are operating as differential type in general, hence there is no direct relation (voltaic) to ground within the module established at all. Indeed, specified information to recommended and maximum voltage levels have to be taken into account.

The basic rule

- Analog measurements always take the form of voltage measurements between two potential points. For voltage measurements a large R is used, in order to ensure a high impedance. For current measurements a small R is used as shunt. If the purpose is resistance measurement, corresponding considerations are applied.
 - Beckhoff generally refers to these two points as input+/signal potential and input-/reference potential.
 - For measurements between two potential points two potentials have to be supplied.
 - Regarding the terms “single-wire connection” or “three-wire connection”, please note the following for pure analog measurements: three- or four-wire connections can be used for sensor supply, but are not involved in the actual analog measurement, which always takes place between two potentials/wires. In particular this also applies to SE, even though the term suggests that only one wire is required.
- The term “electrical isolation” should be clarified in advance. Beckhoff I/O devices feature 1 to 8 or more analog channels; with regard to the channel connection a distinction is made in terms of:
 - how the channels WITHIN a module relate to each other, or
 - how the channels of SEVERAL modules relate to each other.

- The property of electrical isolation indicates whether the channels are directly connected to each other.
- Beckhoff I/O devices always feature electrical isolation between the field/analog side and the bus/EtherCAT side. In other words, if two analog I/O devices are not connected via the power contacts (cable), they are effectively electrically isolated.
- If channels within a device are electrically isolated, or if a single-channel device has no power contacts, the channels are effectively always differential. See also explanatory notes below. Differential channels are not necessarily electrically isolated.
- Analog measuring channels are subject to technical limits, both in terms of the recommended operating range (continuous operation) and the destruction limit. Please refer to the respective device documentation for further details.

Explanation

• Differential (DIFF)

- Differential measurement is the most flexible concept. The user can freely choose both connection points, input+/signal potential and input-/reference potential, within the framework of the technical specification.
- A differential channel can also be operated as SE, if the reference potential of several sensors is linked. This interconnection may take place via the system GND.
- Since a differential channel is configured symmetrically internally (cf. Fig. SE and DIFF module as 2-channel variant), there will be a mid-potential (X) between the two supplied potentials that is the same as the internal ground/reference ground for this channel. If several DIFF channels are used in a module without electrical isolation, the technical property V_{CM} (common-mode voltage) indicates the degree to which the mean voltage of the channels may differ.
- The internal reference ground may be accessible as connection point at the device, in order to stabilize a defined GND potential in the device. In this case it is particularly important to pay attention to the quality of this potential (noiselessness, voltage stability). At this GND point a wire may be connected to make sure that $V_{CM,max}$ is not exceeded in the differential sensor cable. If differential channels are not electrically isolated, usually only one $V_{CM,max}$ is permitted. If the channels are electrically isolated this limit should not apply, and the channels voltages may differ up to the specified separation limit.
- Differential measurement in combination with correct sensor wiring has the special advantage that any interference affecting the sensor cable (ideally the feed and return line are arranged side by side, so that interference signals have the same effect on both wires) has very little effect on the measurement, since the potential of both lines varies jointly (hence the term common mode). In simple terms: Common-mode interference has the same effect on both wires in terms of amplitude and phasing.
- Nevertheless, the suppression of common-mode interference within a channel or between channels is subject to technical limits, which are specified in the technical data.
- Further helpfully information on this topic can be found on the documentation page *Configuration of 0/4..20 mA differential inputs* (see documentation for the EL30xx terminals, for example).

• Single-ended (SE)

- If the analog circuit is designed as SE, the input/reference wire is internally fixed to a certain potential that cannot be changed. This potential must be accessible from outside of the device on at least one point for connecting the reference potential, e.g. via the power contacts (cable).
- In other words, in situations with several channels SE offers users the option to avoid returning at least one of the two sensor cables to the device (in contrast to DIFF). Instead, the reference wire can be consolidated at the sensors, e.g. in the system GND.
- A disadvantage of this approach is that the separate feed and return line can result in voltage/current variations, which a SE channel may no longer be able to handle. See common-mode interference. A V_{CM} effect cannot occur, since the device channels are internally always 'hard-wired' through the input/reference potential.

Typification of the 2/3/4-wire connection of current sensors

Current transducers/sensors/field devices (referred to in the following simply as 'sensor') with the industrial 0/4-20 mA interface typically have internal transformation electronics for the physical measured variable (temperature, current, etc.) at the current control output. These internal electronics must be supplied with energy (voltage, current). The type of cable for this supply thus separates the sensors into *self-supplied* or *externally supplied* sensors:

Self-supplied sensors

- The sensor draws the energy for its own operation via the sensor/signal cable + and -. So that enough energy is always available for the sensor's own operation and open-circuit detection is possible, a lower limit of 4 mA has been specified for the 4-20 mA interface, i.e., the sensor allows a minimum current of 4 mA and a maximum current of 20 mA to pass.
- 2-wire connection see Fig. *2-wire connection*, cf. IEC60381-1
- Such current transducers generally represent a current sink and thus like to sit between + and – as a 'variable load'. See also the data of the sensor manufacturer.

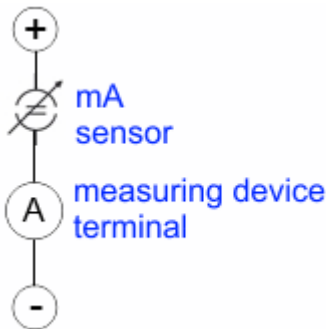

Fig. 17: 2-wire connection

Therefore, they are to be connected according to the Beckhoff terminology as follows:

preferably to '**single-ended**' inputs if the +Supply connections of the device are also to be used - connect to +Supply and Signal.

They can, however, also be connected to '**differential**' inputs, if the termination to GND is then manufactured on the application side – to be connected with the right polarity to +Signal and –Signal. It is important to refer to the information page *Configuration of 0/4...20 mA differential inputs* (see documentation for the EL30xx terminals, for example)!

Externally supplied sensors

No external supply for sensors / actuators

⚠ WARNING

An external supply of sensors / actuators connected to I/O devices of the ELX/EPX series is not permitted!

All I/O devices of the ELX/EPX series are energy-supplying, associated equipment in terms of intrinsic safety. Therefore, connected sensors or actuators are supplied exclusively via the respective channel of the I/O device and must not be externally supplied in any form (e.g. via an additional, external supply voltage).

This limitation is also independent of whether the additional, external supply is energy-limited in the sense of IEC 60079-11.

Connection of any externally powered, intrinsically safe circuits to an I/O device of the ELX/EPX series is contrary to the intended use and the specified [technical data on explosion protection](#) [► 12]. The explosion protection provided by the specified ignition protection type is thus automatically extinguished.

4.2.5 Common-mode voltage and reference ground (based on differential inputs)

Common-mode voltage (V_{cm}) is defined as the average value of the voltages of the individual connections/inputs and is measured/specified against reference ground.

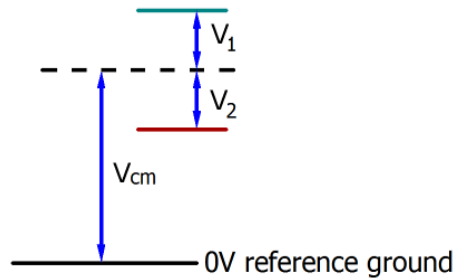

Fig. 18: Common-mode voltage (V_{cm})

The definition of the reference ground is important for the definition of the permitted common-mode voltage range and for measurement of the common-mode rejection ratio (CMRR) for differential inputs.

The reference ground is also the potential against which the input resistance and the input impedance for single-ended inputs or the common-mode resistance and the common-mode impedance for differential inputs is measured.

The reference ground is usually accessible at or near the I/O device. Locations for this can be terminal contacts, power contacts/power line or just a mounting rail.

Please refer to the documentation regarding positioning. The reference ground should be specified for the device under consideration.

For multi-channel I/O devices with resistive (= direct, ohmic, galvanic) or capacitive connection between the channels, the reference ground should preferably be the symmetry point of all channels, taking into account the connection resistances.

Reference ground samples for Beckhoff IO devices:

1. Internal AGND fed out: EL3102/EL3112, resistive connection between the channels
2. 0 V power contact: EL3104/EL3114, resistive connection between the channels and AGND; AGND connected to 0 V power contact with low-resistance
3. Earth or SGND (shield GND):
 - EL3174-0002: Channels have no resistive connection between each other, although they are capacitively coupled to SGND via leakage capacitors
 - EL3314: No internal ground fed out to the terminal points, although capacitive coupling to SGND

4.2.6 Dielectric strength

A distinction should be made between:

- Dielectric strength (destruction limit): Exceedance can result in irreversible changes to the electronics
 - Against a specified reference ground
 - Differential
- Recommended operating voltage range: If the range is exceeded, it can no longer be assumed that the system operates as specified
 - Against a specified reference ground
 - Differential

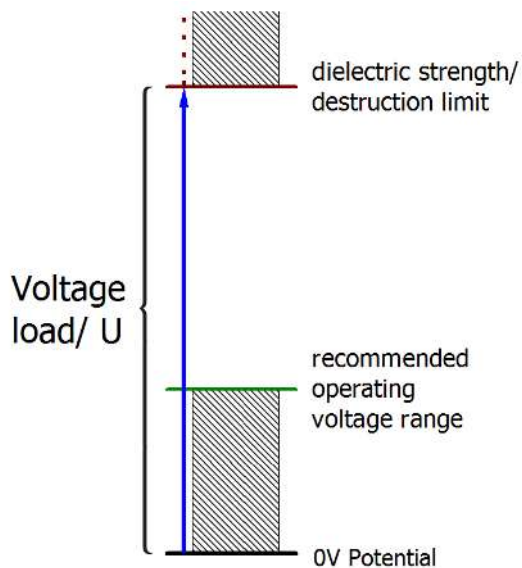

Fig. 19: Recommended operating voltage range

The device documentation may contain particular specifications and timings, taking into account:

- Self-heating
- Rated voltage
- Insulating strength
- Edge steepness of the applied voltage or holding periods
- Normative environment (e.g. PELV)

4.2.7 Temporal aspects of analog/digital conversion

● Analog output



The following information applies analogously to analog signal output via DAC (digital-to-analog converter).

The conversion of the constant electrical input signal to a value-discrete digital and machine-readable form takes place in the analog Beckhoff EL/KL/EP input modules with ADC (analog digital converter). Although different ADC technologies are common, from the user's point of view they all have one common feature: after the end of the conversion, a certain digital value is available for further processing in the controller. This digital value, the so-called analog process data, has a fixed temporal relationship with the “original parameter”, i.e. the electrical input value. Therefore, corresponding temporal characteristic data can be determined and specified for Beckhoff analogue input devices.

This process involves several functional components, which act more or less strongly in every AI (analog input) module:

- the electrical input circuit
- the analog/digital conversion
- the digital further processing
- the final provision of the process and diagnostic data for collection at the fieldbus (EtherCAT, K-bus, etc.)

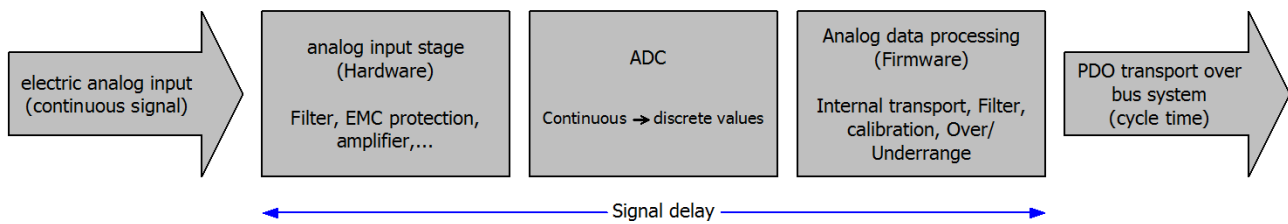

Fig. 20: Signal processing analog input

Two aspects are crucial from a user perspective:

- “How often do I receive new values?”, i.e. a sampling rate in terms of speed with regard to the device/channel
- What delay does the (whole) AD conversion of the device/channel cause?
So hardware and firmware parts in toto. For technological reasons, the signal characteristics must be considered to determine this specification: depending on the signal frequency, there may be different propagation times through the system.

This is the “external” view of the “Beckhoff AI channel” system – internally the signal delay in particular is composed of different components: hardware, amplifier, conversion itself, data transport and processing. Internally a higher sampling rate may be used (e.g. in the deltaSigma converters) than is offered “externally” from the user perspective. From a user perspective of the “Beckhoff AI channel” component this is usually irrelevant or is specified accordingly, if it is relevant for the function.

For Beckhoff AI devices the following specification parameters for the AI channel are available for the user from a temporal perspective:

1. Minimum conversion time [ms, µs]

This is the reciprocal value of the maximum **sampling rate** [Sps, samples per second]:

Specifies how often the analog channel provides a newly detected process data value for collection by the fieldbus. Whether the fieldbus (EtherCAT, K-bus) fetches the value with the same speed (i.e. synchronous), or more quickly (if the AI channel operates in slow FreeRun mode) or more slowly (e.g. with oversampling), is then a question of the fieldbus setting and which modes the AI device supports.

For EtherCAT devices the so-called toggle bit indicates (by toggling) for the diagnostic PDOs when a newly determined analog value is available.

Accordingly, a maximum conversion time, i.e. a smallest sampling rate supported by the AI device, can be specified.

Corresponds to IEC 61131-2 Chap. 7.10.2 2, "Sampling repeat time"

2. Typical signal delay

Corresponds to IEC 61131-2, Chapter 7.10.2 1, "Sampling duration". From this perspective it includes all internal hardware and firmware components, but not "external" delay components from the fieldbus or the controller (TwinCAT).

This delay is particularly relevant for absolute time considerations, if AI channels also provide a timestamp that corresponds to the amplitude value – which can be assumed to match the physically prevailing amplitude value at the time.

Due to the frequency-dependent runtime of a signal, a dedicated value can only be specified for a given signal. The value also depends on possibly changing filter settings of the channel.

A typical characterization in the device documentation can be:

2.1 Signal delay (step response)

Keyword settling time:

The square wave signal can be generated externally with a frequency generator (note impedance!).

The 90% limit is used as detection threshold.

The signal delay [ms, µs] is then the time interval between the (ideal) electrical square wave signal and the time when the analog process value has reached the 90% amplitude.

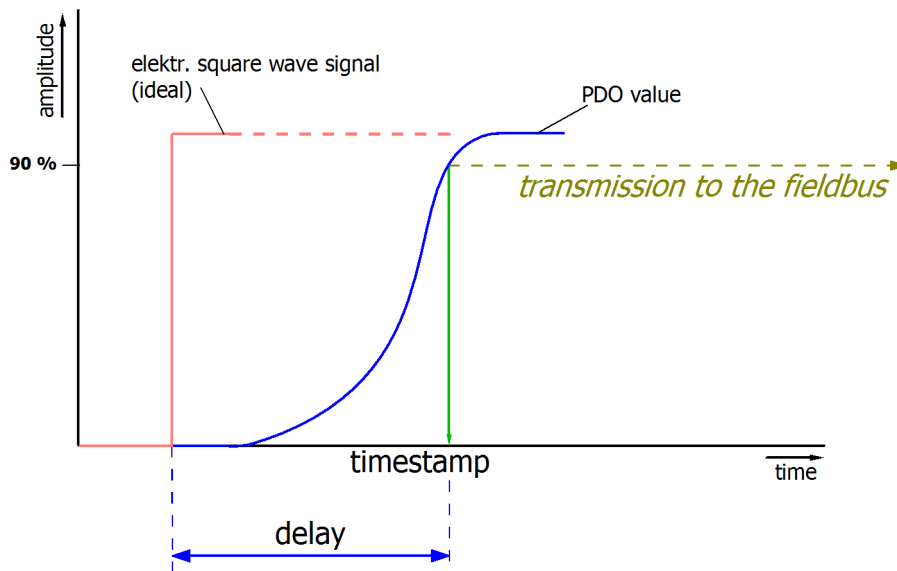

Fig. 21: Diagram Signal delay (step response)

2.2 Signal delay (linear)

Keyword group delay:

Describes the delay of a frequency-constant signal

Test signal can be generated externally with a frequency generator, e.g. as sawtooth or sine. Reference would then be a simultaneous square wave signal.

The signal delay [ms, μ s] is then the time interval between the applied electrical signal of a certain amplitude and the moment when the analog process value reaches the same value.

For this purpose, the test frequency must be selected in a reasonable range; this can be, for example, 1/20 of the maximum sampling rate.

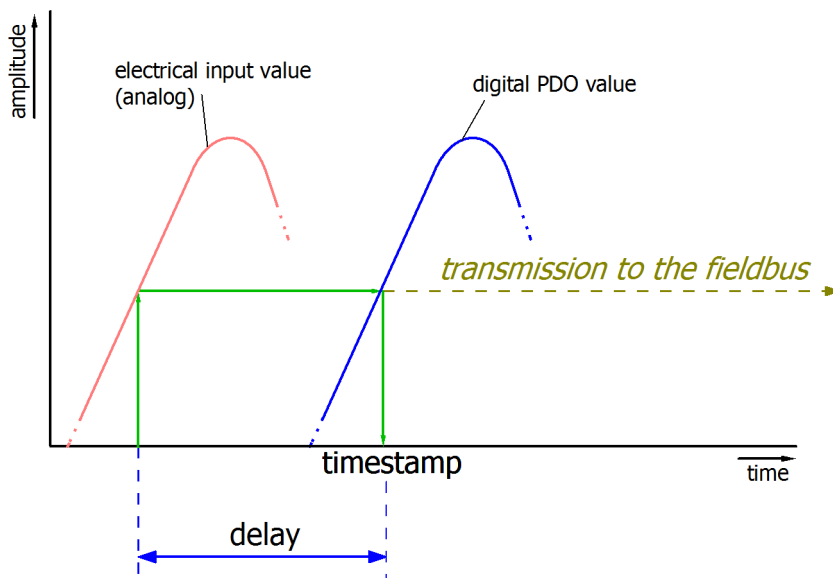

Fig. 22: Diagram Signal delay (linear)

3. Additional information

Additional information may be provided in the specification, e.g.

- actual sampling rate of the ADC (if different from the channel sampling rate)
- time correction values for runtimes with different filter settings
- etc.

4.3 NAMUR basic information

The abbreviation of NAMUR, "User Association of Automation Technology in Process Industries" identifies an international association for users of automation technology that considers the interests related to standardization, devices and measurement control (or similar) of the Process Industries as its major task. In this role, the NAMUR releases the so called NE (proposed standards), each numbered continuously.

Information with regard to the implementation of this recommendation in Beckhoff products are specified in sections "Technical data" and "Process data" of this documentation.

Analog measured values

The analog output value of a sensor that can be measured among other things as a certain current value represents the measurement information (M).

By means of NAMUR NE43 a recommendation – irrespective of the sensor manufacturer – for standardized failure information (A) is defined in addition to the measurement information (e.g. malfunction of a measurement converter, error in connective wires, failure of an auxiliary energy etc.). The failure information states that there is an error in the measuring system. This concerns the analog output signal of sensors in a current loop and therefore in the form of a current value. A current value lying outside of the limits defined by NAMUR is defined as invalid and is thus interpreted as failure information. The following diagram illustrates this:

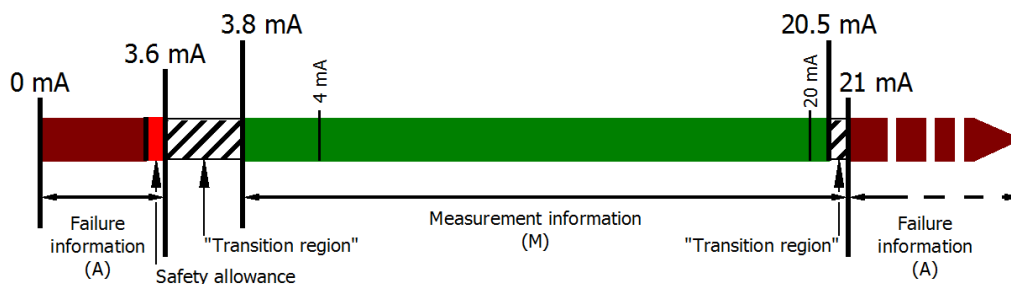

Fig. 23: Representation of the definitions from NAMUR recommendation NE43, version 03/02/2003

5 Parameterization and programming

5.1 Integrating into a TwinCAT project

The procedure for integration in a TwinCAT project is described in these [Quick start guide](#).

5.2 TwinCAT Development Environment

The Software for automation TwinCAT (The Windows Control and Automation Technology) will be distinguished into:

- TwinCAT 2: System Manager (Configuration) & PLC Control (Programming)
- TwinCAT 3: Enhancement of TwinCAT 2 (Programming and Configuration takes place via a common Development Environment)

Details:

- **TwinCAT 2:**
 - Connects I/O devices to tasks in a variable-oriented manner
 - Connects tasks to tasks in a variable-oriented manner
 - Supports units at the bit level
 - Supports synchronous or asynchronous relationships
 - Exchange of consistent data areas and process images
 - Datalink on NT - Programs by open Microsoft Standards (OLE, OCX, ActiveX, DCOM+, etc.)
 - Integration of IEC 61131-3-Software-SPS, Software- NC and Software-CNC within Windows NT/ 2000/XP/Vista, Windows 7, NT/XP Embedded, CE
 - Interconnection to all common fieldbusses
 - [More...](#)

Additional features:

- **TwinCAT 3 (eXtended Automation):**
 - Visual-Studio®-Integration
 - Choice of the programming language
 - Supports object orientated extension of IEC 61131-3
 - Usage of C/C++ as programming language for real time applications
 - Connection to MATLAB®/Simulink®
 - Open interface for expandability
 - Flexible run-time environment
 - Active support of Multi-Core- und 64-Bit-Operatingsystem
 - Automatic code generation and project creation with the TwinCAT Automation Interface
 - [More...](#)

Within the following sections commissioning of the TwinCAT Development Environment on a PC System for the control and also the basically functions of unique control elements will be explained.

Please see further information to TwinCAT 2 and TwinCAT 3 at <http://infosys.beckhoff.com>.

5.2.1 Installation of the TwinCAT real-time driver

In order to assign real-time capability to a standard Ethernet port of an IPC controller, the Beckhoff real-time driver has to be installed on this port under Windows.

This can be done in several ways. One option is described here.

In the System Manager call up the TwinCAT overview of the local network interfaces via Options → Show Real Time Ethernet Compatible Devices.

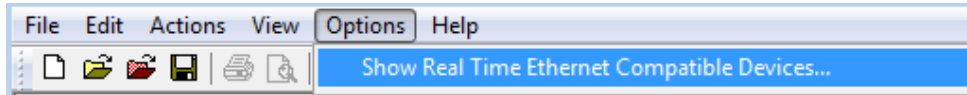

Fig. 24: System Manager “Options” (TwinCAT 2)

This has to be called up by the Menü “TwinCAT” within the TwinCAT 3 environment:

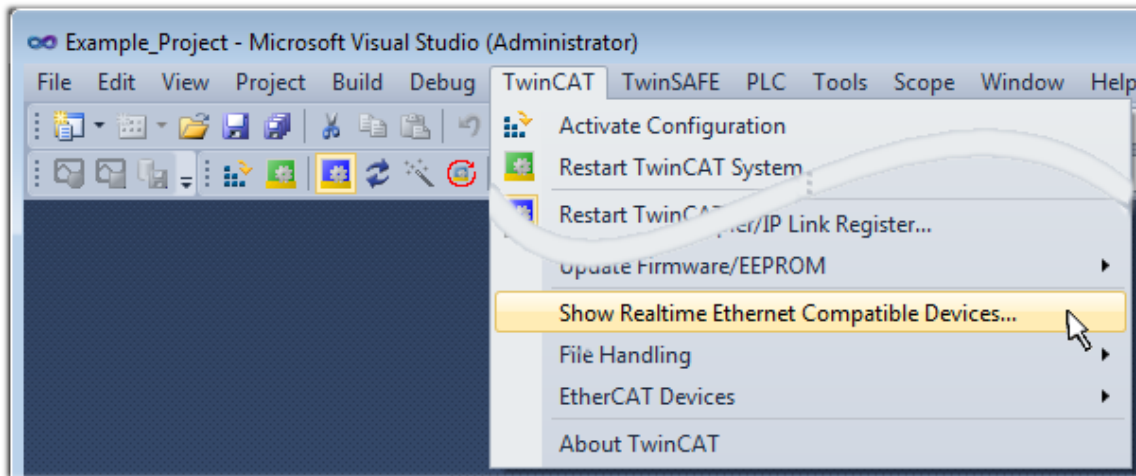

Fig. 25: Call up under VS Shell (TwinCAT 3)

The following dialog appears:

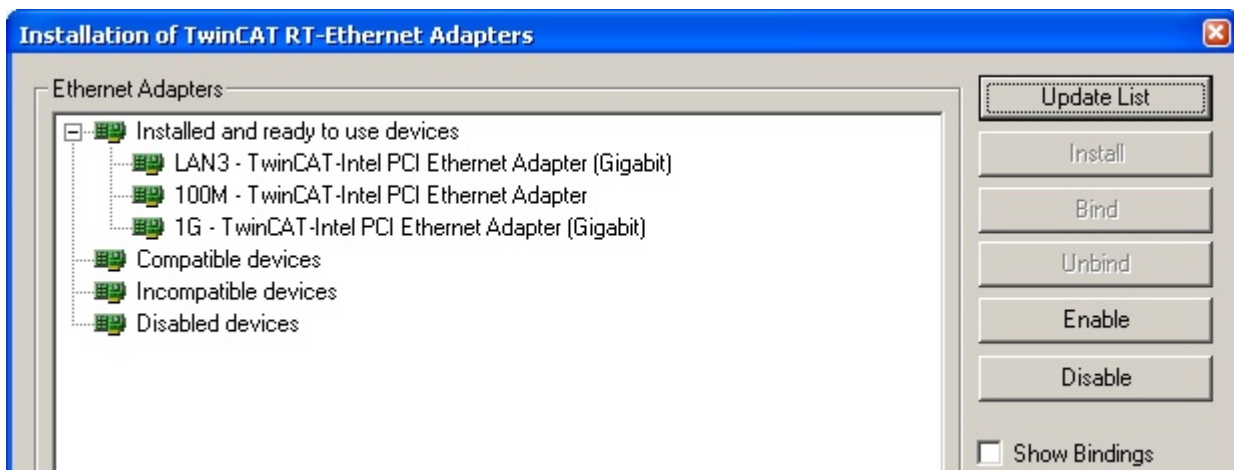

Fig. 26: Overview of network interfaces

Interfaces listed under “Compatible devices” can be assigned a driver via the “Install” button. A driver should only be installed on compatible devices.

A Windows warning regarding the unsigned driver can be ignored.

Alternatively an EtherCAT-device can be inserted first of all as described in chapter [Offline configuration creation](#), section “Creating the EtherCAT device” [▶ 46] in order to view the compatible ethernet ports via its EtherCAT properties (tab “Adapter”, button “Compatible Devices...”):



Fig. 27: EtherCAT device properties(TwinCAT 2): click on “Compatible Devices...” of tab “Adapte”

TwinCAT 3: the properties of the EtherCAT device can be opened by double click on “Device .. (EtherCAT)” within the Solution Explorer under “I/O”:

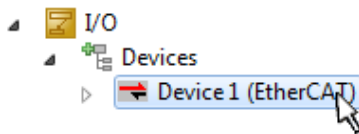

After the installation the driver appears activated in the Windows overview for the network interface (Windows Start → System Properties → Network)

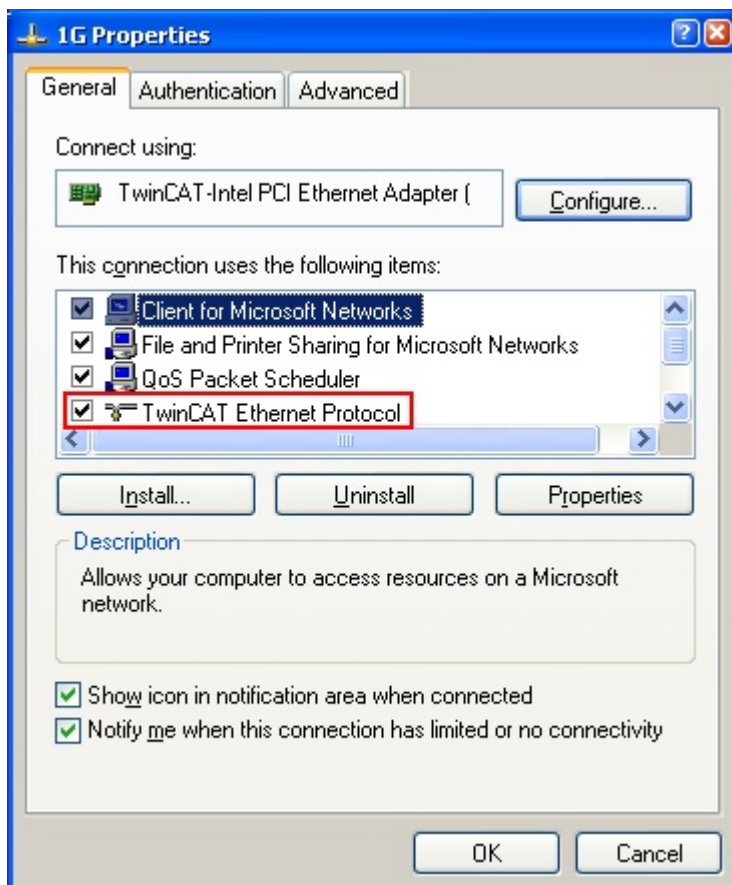

Fig. 28: Windows properties of the network interface

A correct setting of the driver could be:

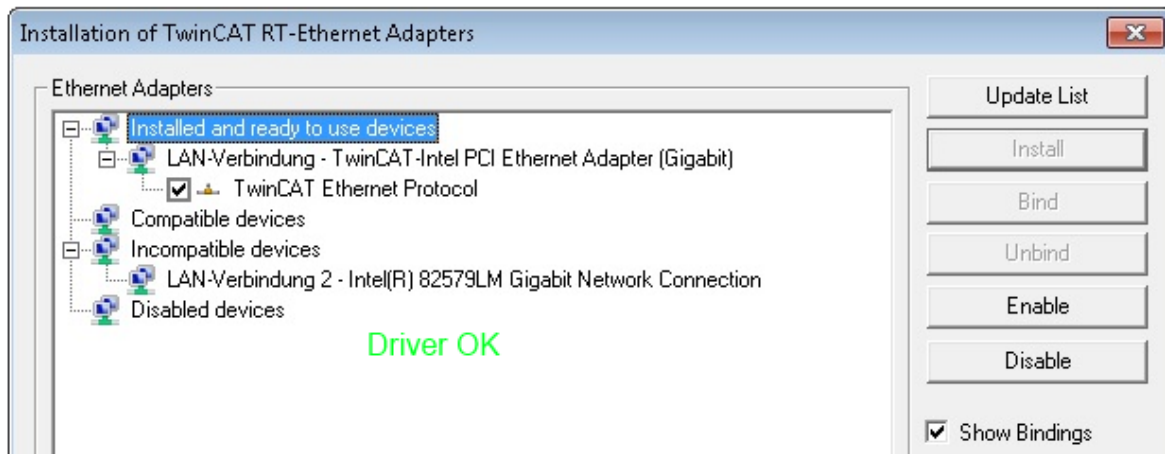

Fig. 29: Exemplary correct driver setting for the Ethernet port

Other possible settings have to be avoided:

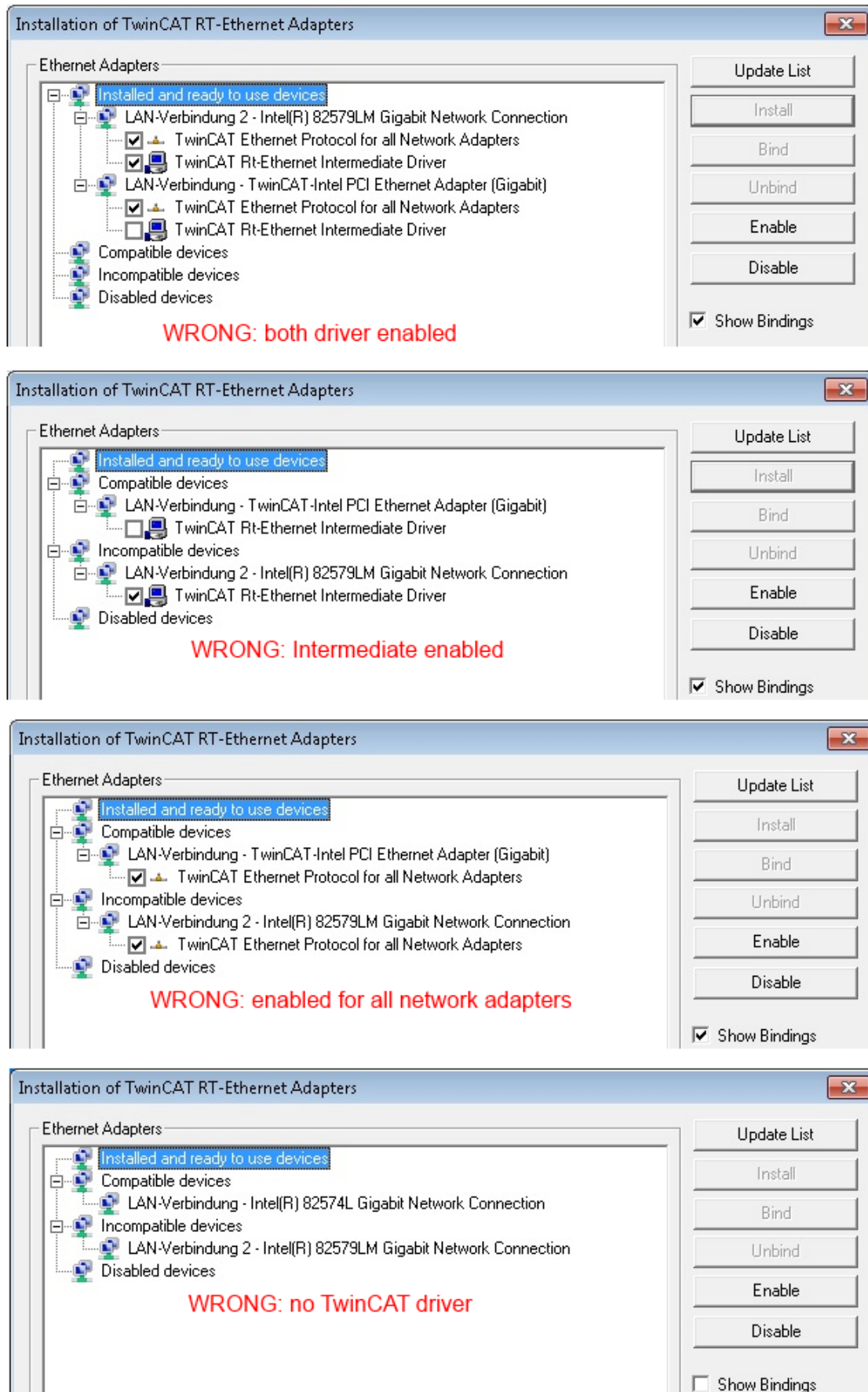

Fig. 30: Incorrect driver settings for the Ethernet port

IP address of the port used

i IP address/DHCP

In most cases an Ethernet port that is configured as an EtherCAT device will not transport general IP packets. For this reason and in cases where an EL6601 or similar devices are used it is useful to specify a fixed IP address for this port via the “Internet Protocol TCP/IP” driver setting and to disable DHCP. In this way the delay associated with the DHCP client for the Ethernet port assigning itself a default IP address in the absence of a DHCP server is avoided. A suitable address space is 192.168.x.x, for example.

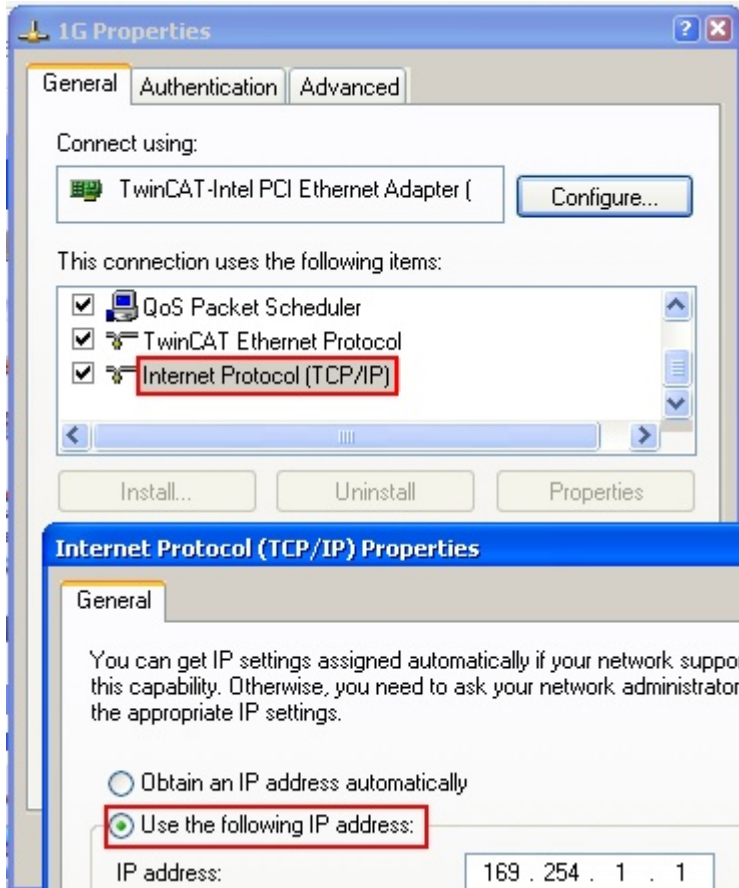

Fig. 31: TCP/IP setting for the Ethernet port

5.2.2 Notes regarding ESI device description

Installation of the latest ESI device description

The TwinCAT EtherCAT master/System Manager needs the device description files for the devices to be used in order to create the configuration in online or offline mode. The device descriptions are contained in the so-called ESI files (EtherCAT Slave Information) in XML format. These files can be requested from the respective vendor and are made available for download. An *.xml file may contain several device descriptions.

The ESIs for Beckhoff EtherCAT devices are provided on the [Beckhoff website](#).

The ESI files must be stored in the TwinCAT installation directory.

Default settings:

- **TwinCAT 2:** C:\TwinCAT\IO\EtherCAT
- **TwinCAT 3:** C:\TwinCAT\3.1\Config\Io\EtherCAT

The files are read (once) when a new System Manager window is opened, if they have changed since the last time the System Manager window was opened.

A TwinCAT installation includes the set of Beckhoff ESI files that was current at the time when the TwinCAT build was created.

From TwinCAT 2.11 / TwinCAT 3 on the ESI directory can be updated from the System Manager if the programming PC is connected to the internet; at

TwinCAT 2: Options → „Update EtherCAT Device Descriptions“

TwinCAT 3: TwinCAT → EtherCAT Devices → “Update Device Descriptions (via ETG Website)...”

The TwinCAT ESI Updater is available for this purpose.



ESI

The *.xml files are associated with *.xsd files, which describe the structure of the ESI XML files. To update the ESI device descriptions, both file types should therefore be updated.

Device differentiation

EtherCAT devices/slaves are distinguished by four properties, which determine the full device identifier. For example, the device identifier EL2521-0025-1018 consists of:

- family key “EL”
- name “2521”
- type “0025”
- and revision “1018”

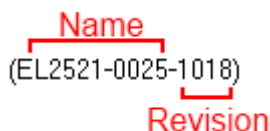

Fig. 32: Identifier structure

The order identifier consisting of name + type (here: EL2521-0010) describes the device function. The revision indicates the technical progress and is managed by Beckhoff. In principle, a device with a higher revision can replace a device with a lower revision, unless specified otherwise, e.g. in the documentation. Each revision has its own ESI description. See further notes.

Online description

If the EtherCAT configuration is created online through scanning of real devices (see section Online setup) and no ESI descriptions are available for a slave (specified by name and revision) that was found, the System Manager asks whether the description stored in the device should be used. In any case, the System Manager needs this information for setting up the cyclic and acyclic communication with the slave correctly.

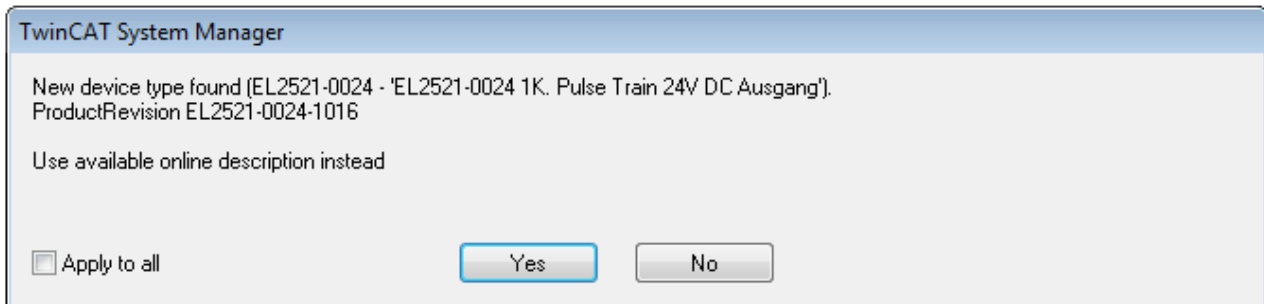

Fig. 33: OnlineDescription information window (TwinCAT 2)

In TwinCAT 3 a similar window appears, which also offers the Web update:

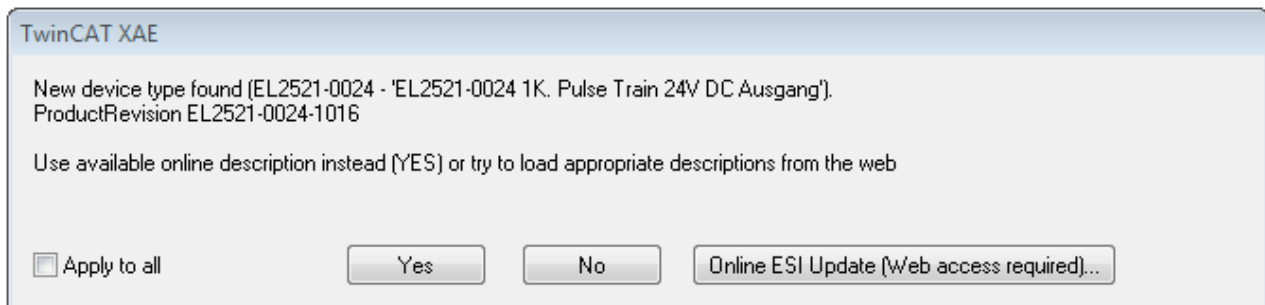

Fig. 34: Information window OnlineDescription (TwinCAT 3)

If possible, the Yes is to be rejected and the required ESI is to be requested from the device manufacturer. After installation of the XML/XSD file the configuration process should be repeated.

NOTE

Changing the “usual” configuration through a scan

- ✓ If a scan discovers a device that is not yet known to TwinCAT, distinction has to be made between two cases. Taking the example here of the EL2521-0000 in the revision 1019
 - a) no ESI is present for the EL2521-0000 device at all, either for the revision 1019 or for an older revision. The ESI must then be requested from the manufacturer (in this case Beckhoff).
 - b) an ESI is present for the EL2521-0000 device, but only in an older revision, e.g. 1018 or 1017. In this case an in-house check should first be performed to determine whether the spare parts stock allows the integration of the increased revision into the configuration at all. A new/higher revision usually also brings along new features. If these are not to be used, work can continue without reservations with the previous revision 1018 in the configuration. This is also stated by the Beckhoff compatibility rule.

Refer in particular to the chapter “[General notes on the use of Beckhoff EtherCAT IO components](#)” and for manual configuration to the chapter “[Offline configuration creation](#)”.

If the OnlineDescription is used regardless, the System Manager reads a copy of the device description from the EEPROM in the EtherCAT slave. In complex slaves the size of the EEPROM may not be sufficient for the complete ESI, in which case the ESI would be *incomplete* in the configurator. Therefore it's recommended using an offline ESI file with priority in such a case.

The System Manager creates for online recorded device descriptions a new file “OnlineDescription0000...xml” in its ESI directory, which contains all ESI descriptions that were read online.

OnlineDescriptionCache00000002.xml

Fig. 35: File OnlineDescription.xml created by the System Manager

If a slave desired to be added manually to the configuration at a later stage, online created slaves are indicated by a prepended symbol ">" in the selection list (see Figure *Indication of an online recorded ESI of EL2521 as an example*).

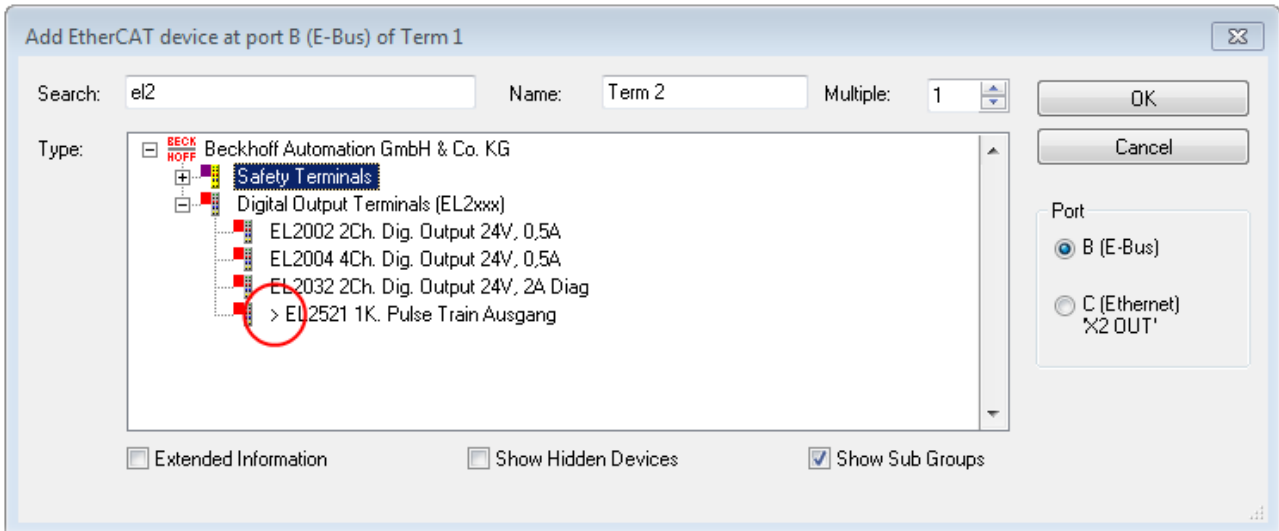

Fig. 36: Indication of an online recorded ESI of EL2521 as an example

If such ESI files are used and the manufacturer's files become available later, the file OnlineDescription.xml should be deleted as follows:

- close all System Manager windows
- restart TwinCAT in Config mode
- delete "OnlineDescription0000...xml"
- restart TwinCAT System Manager

This file should not be visible after this procedure, if necessary press <F5> to update

i OnlineDescription for TwinCAT 3.x

In addition to the file described above "OnlineDescription0000...xml", a so called EtherCAT cache with new discovered devices is created by TwinCAT 3.x, e.g. under Windows 7:

C:\User\[USERNAME]\AppData\Roaming\Beckhoff\TwinCAT3\Components\Base\EtherCATCache.xml

(Please note the language settings of the OS!)

You have to delete this file, too.

Faulty ESI file

If an ESI file is faulty and the System Manager is unable to read it, the System Manager brings up an information window.

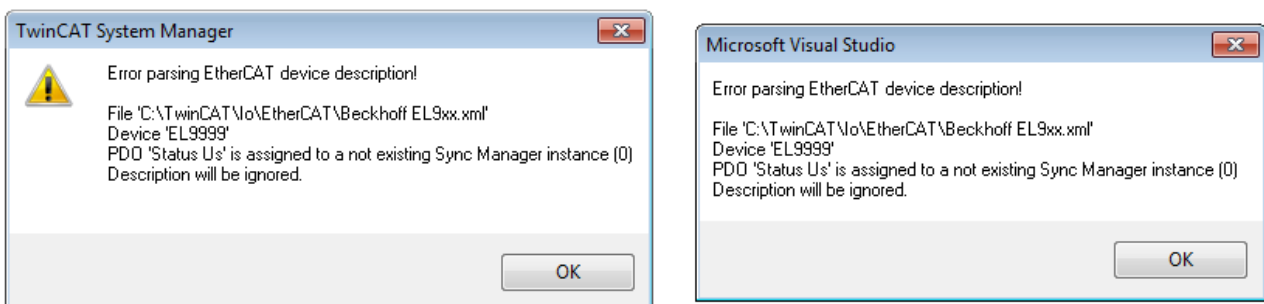

Fig. 37: Information window for faulty ESI file (left: TwinCAT 2; right: TwinCAT 3)

Reasons may include:

- Structure of the *.xml does not correspond to the associated *.xsd file → check your schematics
- Contents cannot be translated into a device description → contact the file manufacturer

5.2.3 TwinCAT ESI Updater

For TwinCAT 2.11 and higher, the System Manager can search for current Beckhoff ESI files automatically, if an online connection is available:

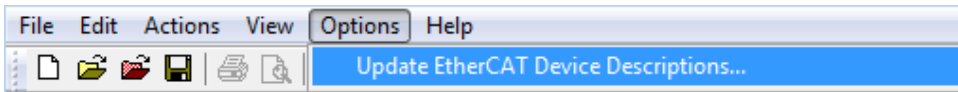

Fig. 38: Using the ESI Updater (>= TwinCAT 2.11)

The call up takes place under:
 “Options” → “Update EtherCAT Device Descriptions”

Selection under TwinCAT 3:

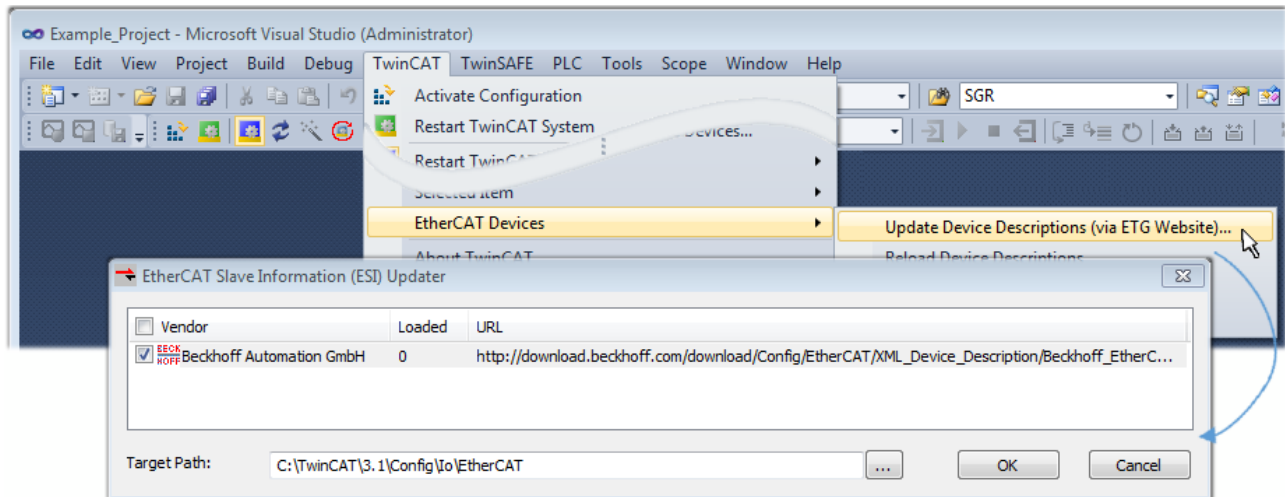

Fig. 39: Using the ESI Updater (TwinCAT 3)

The ESI Updater (TwinCAT 3) is a convenient option for automatic downloading of ESI data provided by EtherCAT manufacturers via the Internet into the TwinCAT directory (ESI = EtherCAT slave information). TwinCAT accesses the central ESI ULR directory list stored at ETG; the entries can then be viewed in the Updater dialog, although they cannot be changed there.

The call up takes place under:
 “TwinCAT” → “EtherCAT Devices” → “Update Device Description (via ETG Website)...”.

5.2.4 Distinction between Online and Offline

The distinction between online and offline refers to the presence of the actual I/O environment (drives, terminals, EJ-modules). If the configuration is to be prepared in advance of the system configuration as a programming system, e.g. on a laptop, this is only possible in “Offline configuration” mode. In this case all components have to be entered manually in the configuration, e.g. based on the electrical design.

If the designed control system is already connected to the EtherCAT system and all components are energised and the infrastructure is ready for operation, the TwinCAT configuration can simply be generated through “scanning” from the runtime system. This is referred to as online configuration.

In any case, during each startup the EtherCAT master checks whether the slaves it finds match the configuration. This test can be parameterised in the extended slave settings. Refer to note “Installation of the latest ESI-XML device description”.

For preparation of a configuration:

- the real EtherCAT hardware (devices, couplers, drives) must be present and installed
- the devices/modules must be connected via EtherCAT cables or in the terminal/ module strand in the same way as they are intended to be used later

- the devices/modules be connected to the power supply and ready for communication
- TwinCAT must be in CONFIG mode on the target system.

The online scan process consists of:

- detecting the EtherCAT device [▶ 51] (Ethernet port at the IPC)
- detecting the connected EtherCAT devices [▶ 52]. This step can be carried out independent of the preceding step
- troubleshooting [▶ 55]

The scan with existing configuration [▶ 56] can also be carried out for comparison.

5.2.5 OFFLINE configuration creation

Creating the EtherCAT device

Create an EtherCAT device in an empty System Manager window.

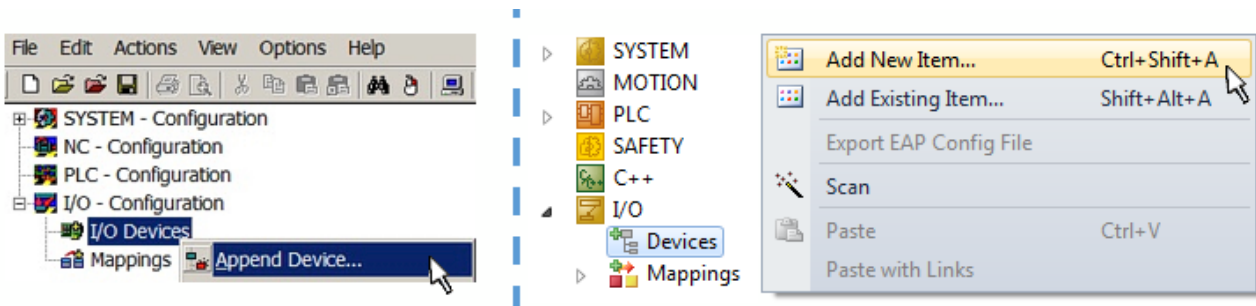

Fig. 40: Append EtherCAT device (left: TwinCAT 2; right: TwinCAT 3)

Select type “EtherCAT” for an EtherCAT I/O application with EtherCAT slaves. For the present publisher/ subscriber service in combination with an EL6601/EL6614 terminal select “EtherCAT Automation Protocol via EL6601”.

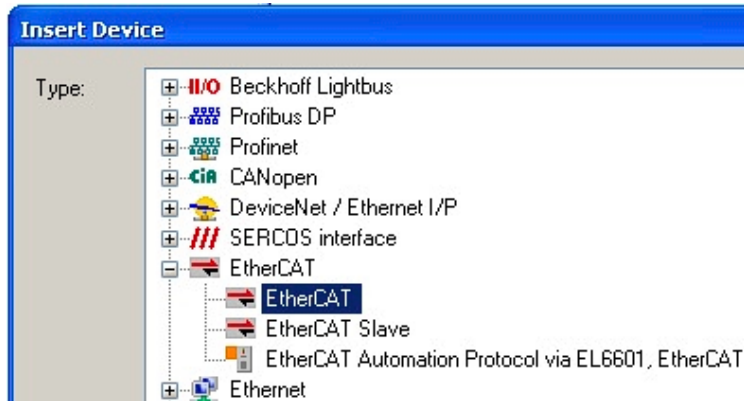

Fig. 41: Selecting the EtherCAT connection (TwinCAT 2.11, TwinCAT 3)

Then assign a real Ethernet port to this virtual device in the runtime system.

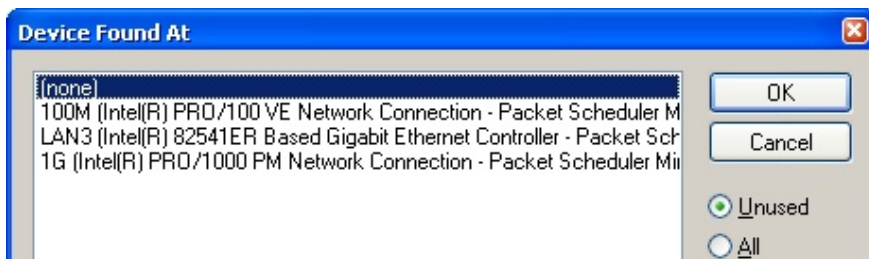

Fig. 42: Selecting the Ethernet port

This query may appear automatically when the EtherCAT device is created, or the assignment can be set/modified later in the properties dialog; see Fig. “EtherCAT device properties (TwinCAT 2)”.

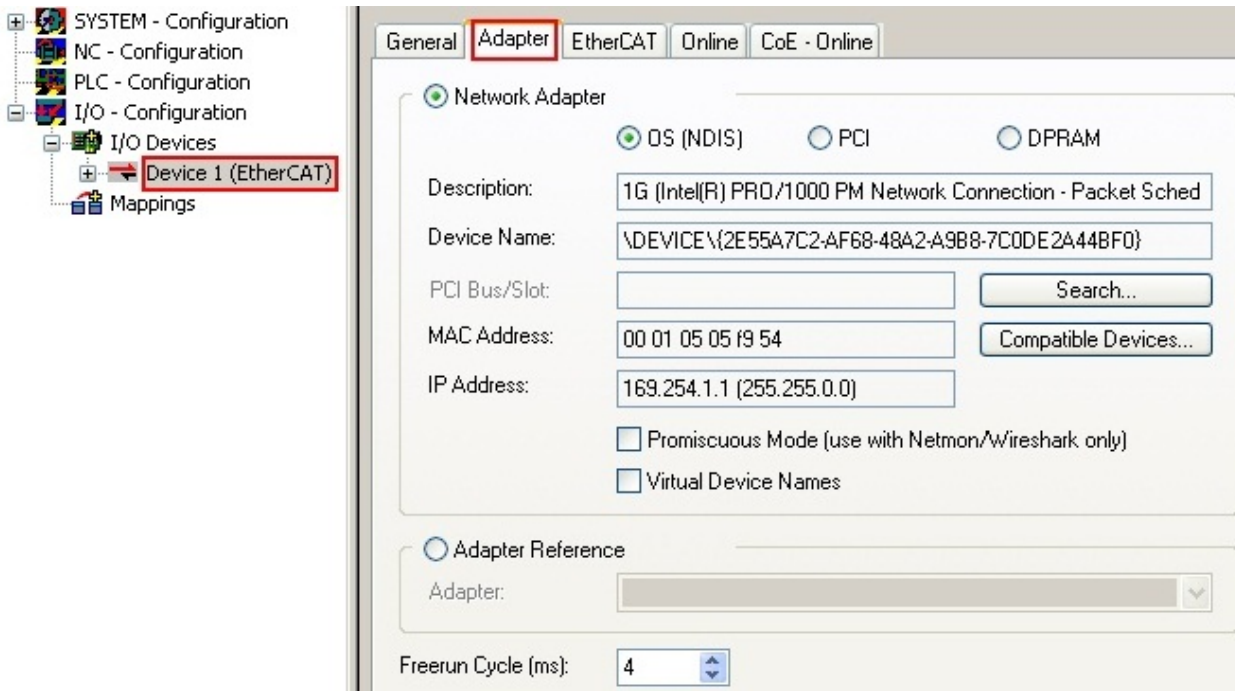
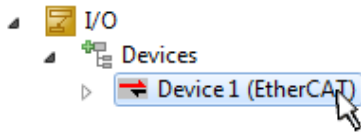

Fig. 43: EtherCAT device properties (TwinCAT 2)

TwinCAT 3: the properties of the EtherCAT device can be opened by double click on “Device .. (EtherCAT)” within the Solution Explorer under “I/O”:



i **Selecting the Ethernet port**

Ethernet ports can only be selected for EtherCAT devices for which the TwinCAT real-time driver is installed. This has to be done separately for each port. Please refer to the respective installation page.

Defining EtherCAT slaves

Further devices can be appended by right-clicking on a device in the configuration tree.

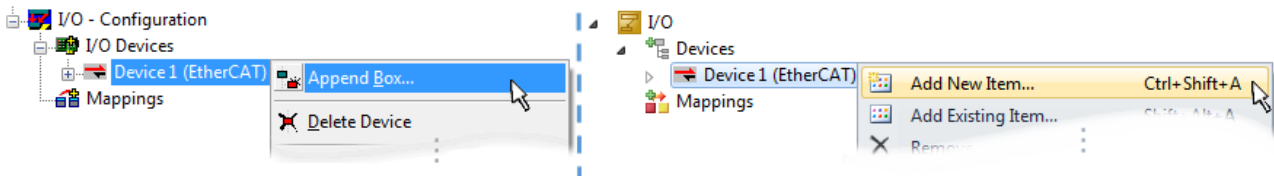

Fig. 44: Appending EtherCAT devices (left: TwinCAT 2; right: TwinCAT 3)

The dialog for selecting a new device opens. Only devices for which ESI files are available are displayed.

Only devices are offered for selection that can be appended to the previously selected device. Therefore the physical layer available for this port is also displayed (Fig. “Selection dialog for new EtherCAT device”, A). In the case of cable-based Fast-Ethernet physical layer with PHY transfer, then also only cable-based devices are available, as shown in Fig. “Selection dialog for new EtherCAT device”. If the preceding device has several free ports (e.g. EK1122 or EK1100), the required port can be selected on the right-hand side (A).

Overview of physical layer

- “Ethernet”: cable-based 100BASE-TX: EK couplers, EP boxes, devices with RJ45/M8/M12 connector

- “E-Bus”: LVDS “terminal bus”, “EJ-module”: EL/ES terminals, various modular modules

The search field facilitates finding specific devices (since TwinCAT 2.11 or TwinCAT 3).

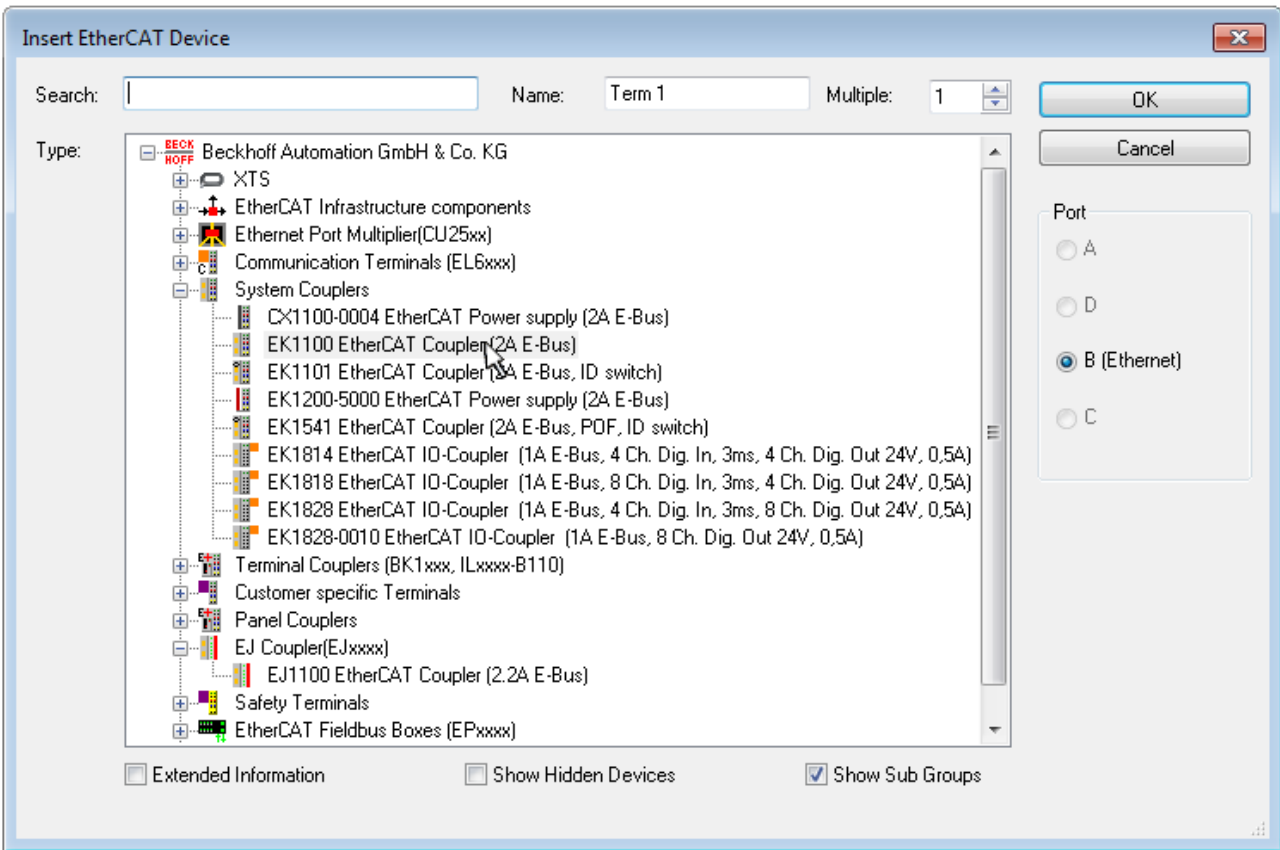

Fig. 45: Selection dialog for new EtherCAT device

By default only the name/device type is used as selection criterion. For selecting a specific revision of the device the revision can be displayed as “Extended Information”.

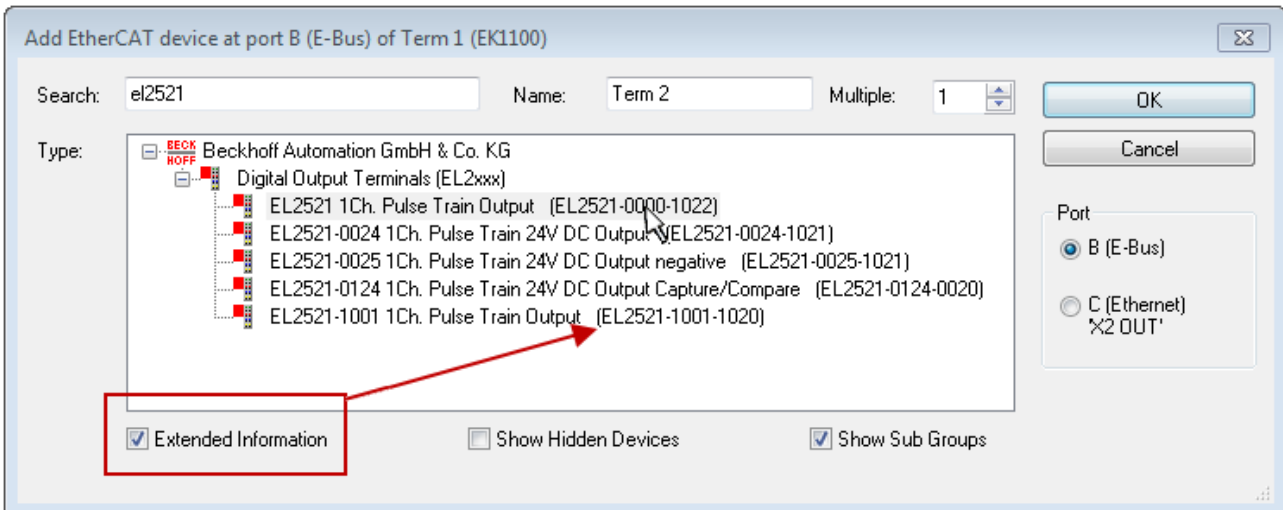

Fig. 46: Display of device revision

In many cases several device revisions were created for historic or functional reasons, e.g. through technological advancement. For simplification purposes (see Fig. “Selection dialog for new EtherCAT device”) only the last (i.e. highest) revision and therefore the latest state of production is displayed in the selection dialog for Beckhoff devices. To show all device revisions available in the system as ESI descriptions tick the “Show Hidden Devices” check box, see Fig. “Display of previous revisions”.

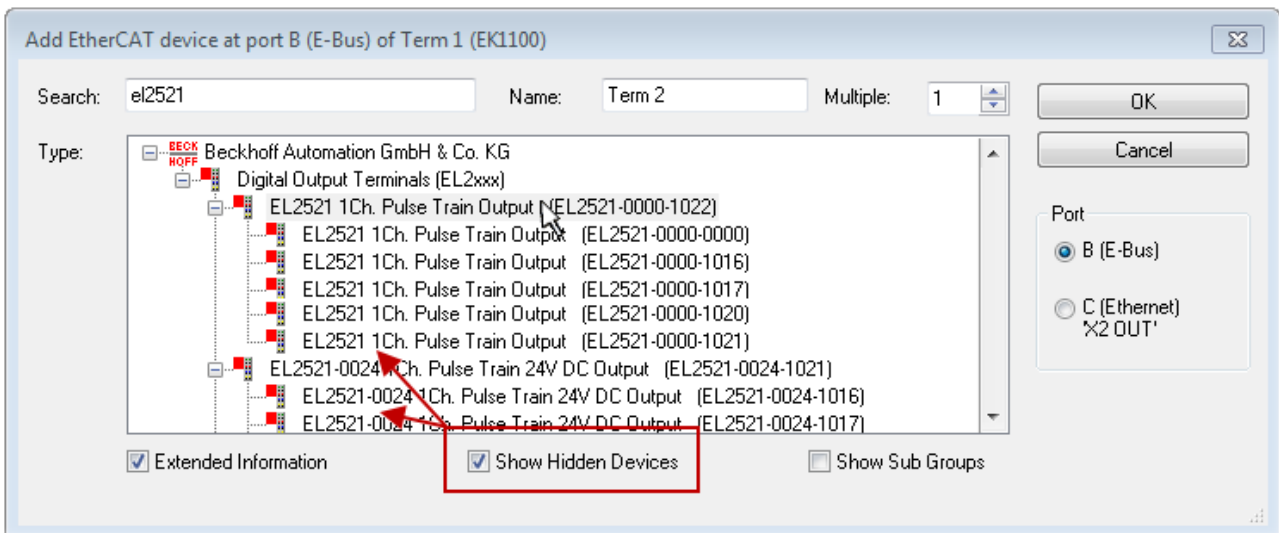

Fig. 47: Display of previous revisions

i Device selection based on revision, compatibility

The ESI description also defines the process image, the communication type between master and slave/device and the device functions, if applicable. The physical device (firmware, if available) has to support the communication queries/settings of the master. This is backward compatible, i.e. newer devices (higher revision) should be supported if the EtherCAT master addresses them as an older revision. The following compatibility rule of thumb is to be assumed for Beckhoff EtherCAT Terminals/ Boxes/ EJ-modules:

device revision in the system >= device revision in the configuration

This also enables subsequent replacement of devices without changing the configuration (different specifications are possible for drives).

Example

If an EL2521-0025-1018 is specified in the configuration, an EL2521-0025-1018 or higher (-1019, -1020) can be used in practice.

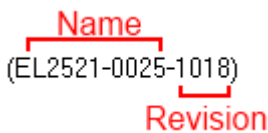

Fig. 48: Name/revision of the terminal

If current ESI descriptions are available in the TwinCAT system, the last revision offered in the selection dialog matches the Beckhoff state of production. It is recommended to use the last device revision when creating a new configuration, if current Beckhoff devices are used in the real application. Older revisions should only be used if older devices from stock are to be used in the application.

In this case the process image of the device is shown in the configuration tree and can be parameterized as follows: linking with the task, CoE/DC settings, plug-in definition, startup settings, ...

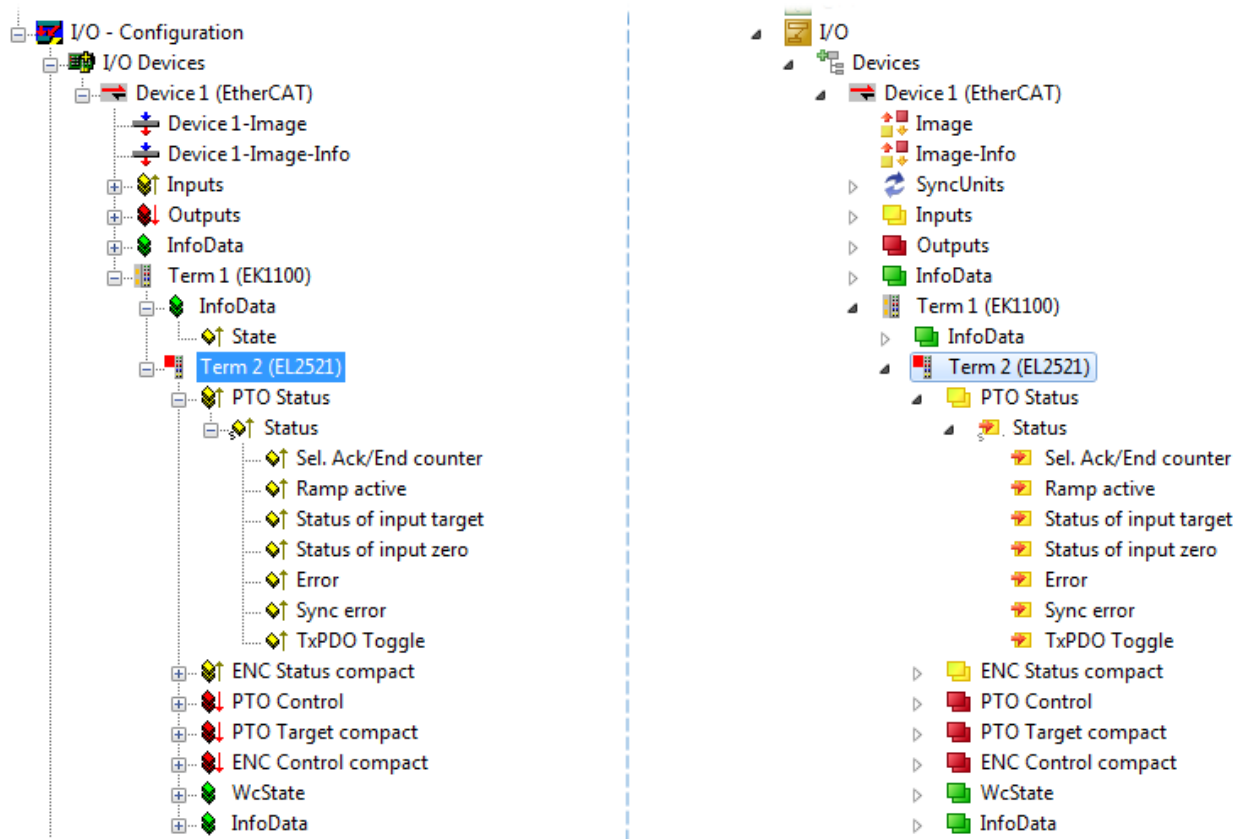



Fig. 49: EtherCAT terminal in the TwinCAT tree (left: TwinCAT 2; right: TwinCAT 3)



5.2.6 ONLINE configuration creation

Detecting/scanning of the EtherCAT device

The online device search can be used if the TwinCAT system is in CONFIG mode. This can be indicated by a symbol right below in the information bar:



- on TwinCAT 2 by a blue display “Config Mode” within the System Manager window:  .
- on TwinCAT 3 within the user interface of the development environment by a symbol  .

TwinCAT can be set into this mode:

- TwinCAT 2: by selection of  in the Menubar or by “Actions” → “Set/Reset TwinCAT to Config Mode...”
- TwinCAT 3: by selection of  in the Menubar or by “TwinCAT” → “Restart TwinCAT (Config Mode)”

● Online scanning in Config mode

i The online search is not available in RUN mode (production operation). Note the differentiation between TwinCAT programming system and TwinCAT target system.

The TwinCAT 2 icon () or TwinCAT 3 icon () within the Windows-Taskbar always shows the TwinCAT mode of the local IPC. Compared to that, the System Manager window of TwinCAT 2 or the user interface of TwinCAT 3 indicates the state of the target system.

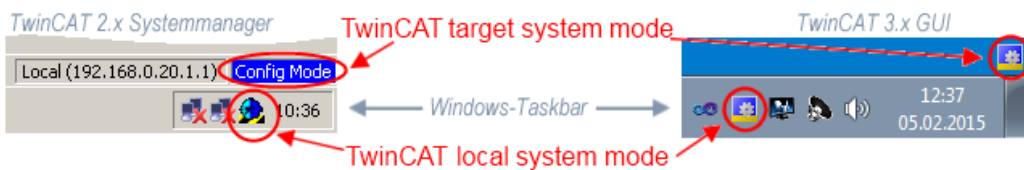

Fig. 50: Differentiation local/target system (left: TwinCAT 2; right: TwinCAT 3)

Right-clicking on “I/O Devices” in the configuration tree opens the search dialog.

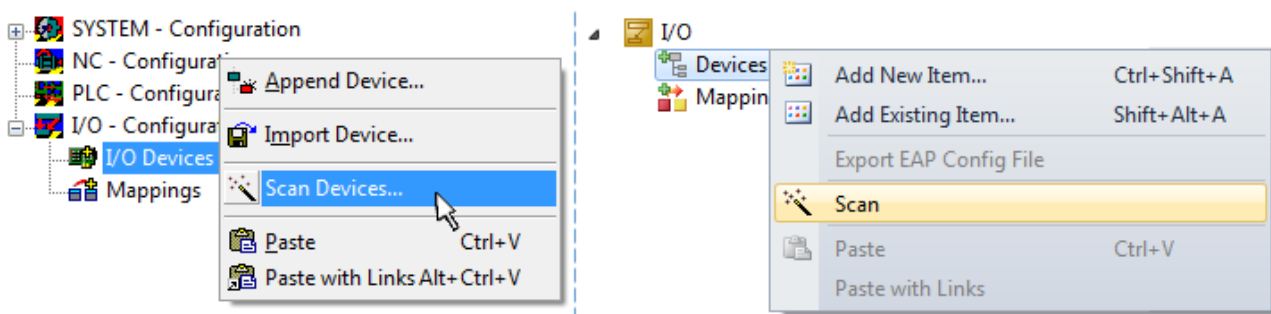

Fig. 51: Scan Devices (left: TwinCAT 2; right: TwinCAT 3)

This scan mode attempts to find not only EtherCAT devices (or Ethernet ports that are usable as such), but also NOVRAM, fieldbus cards, SMB etc. However, not all devices can be found automatically.

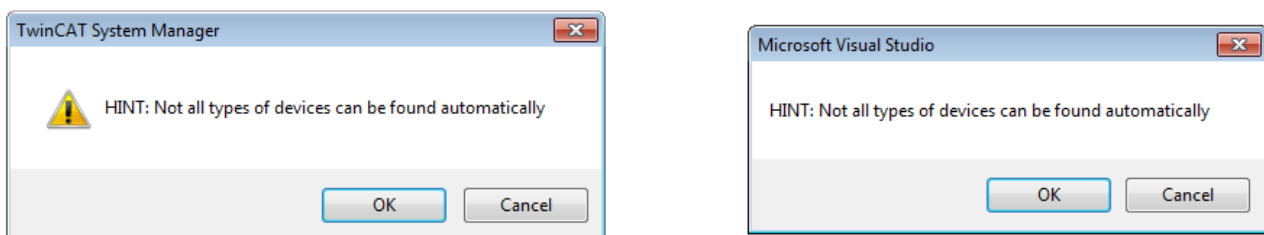

Fig. 52: Note for automatic device scan (left: TwinCAT 2; right: TwinCAT 3)

Ethernet ports with installed TwinCAT real-time driver are shown as “RT Ethernet” devices. An EtherCAT frame is sent to these ports for testing purposes. If the scan agent detects from the response that an EtherCAT slave is connected, the port is immediately shown as an “EtherCAT Device” .

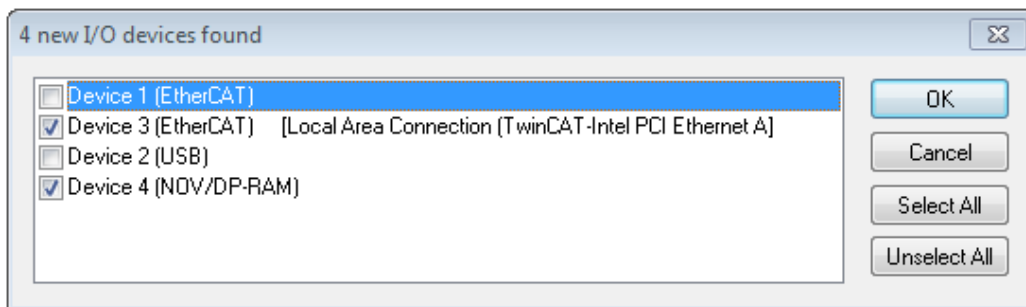

Fig. 53: Detected Ethernet devices

Via respective checkboxes devices can be selected (as illustrated in Fig. “Detected Ethernet devices” e.g. Device 3 and Device 4 were chosen). After confirmation with “OK” a device scan is suggested for all selected devices, see Fig.: “Scan query after automatic creation of an EtherCAT device”.

● Selecting the Ethernet port

i Ethernet ports can only be selected for EtherCAT devices for which the TwinCAT real-time driver is installed. This has to be done separately for each port. Please refer to the respective installation page.

Detecting/Scanning the EtherCAT devices

● Online scan functionality

i During a scan the master queries the identity information of the EtherCAT slaves from the slave EEPROM. The name and revision are used for determining the type. The respective devices are located in the stored ESI data and integrated in the configuration tree in the default state defined there.

Name
(EL2521-0025-1018)
Revision

Fig. 54: Example default state

NOTE

Slave scanning in practice in series machine production

The scanning function should be used with care. It is a practical and fast tool for creating an initial configuration as a basis for commissioning. In series machine production or reproduction of the plant, however, the function should no longer be used for the creation of the configuration, but if necessary for comparison [► 56] with the defined initial configuration. Background: since Beckhoff occasionally increases the revision version of the delivered products for product maintenance reasons, a configuration can be created by such a scan which (with an identical machine construction) is identical according to the device list; however, the respective device revision may differ from the initial configuration.

Example:

Company A builds the prototype of a machine B, which is to be produced in series later on. To do this the prototype is built, a scan of the IO devices is performed in TwinCAT and the initial configuration “B.tsm” is created. The EL2521-0025 EtherCAT terminal with the revision 1018 is located somewhere. It is thus built into the TwinCAT configuration in this way:

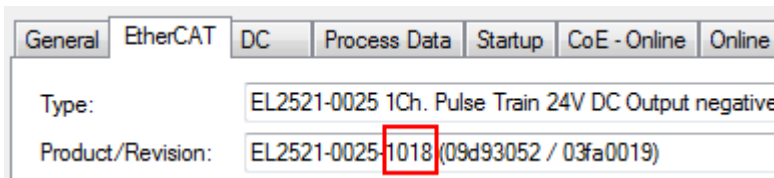

Fig. 55: Installing EthetCAT terminal with revision -1018

Likewise, during the prototype test phase, the functions and properties of this terminal are tested by the programmers/commissioning engineers and used if necessary, i.e. addressed from the PLC “B.pro” or the NC. (the same applies correspondingly to the TwinCAT 3 solution files).

The prototype development is now completed and series production of machine B starts, for which Beckhoff continues to supply the EL2521-0025-0018. If the commissioning engineers of the series machine production department always carry out a scan, a B configuration with the identical contents results again for each machine. Likewise, A might create spare parts stores worldwide for the coming series-produced machines with EL2521-0025-1018 terminals.

After some time Beckhoff extends the EL2521-0025 by a new feature C. Therefore the FW is changed, outwardly recognizable by a higher FW version and a **new revision -1019**. Nevertheless the new device naturally supports functions and interfaces of the predecessor version(s); an adaptation of “B.tsm” or even “B.pro” is therefore unnecessary. The series-produced machines can continue to be built with “B.tsm” and “B.pro”; it makes sense to perform a comparative scan [► 56] against the initial configuration “B.tsm” in order to check the built machine.

However, if the series machine production department now doesn't use “B.tsm”, but instead carries out a scan to create the productive configuration, the revision **-1019** is automatically detected and built into the configuration:

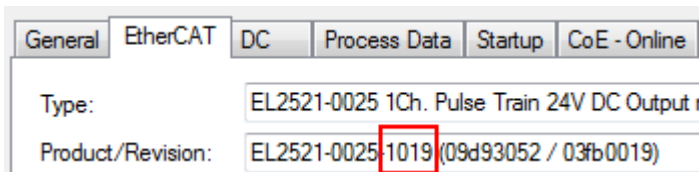

Fig. 56: Detection of EtherCAT terminal with revision -1019

This is usually not noticed by the commissioning engineers. TwinCAT cannot signal anything either, since virtually a new configuration is created. According to the compatibility rule, however, this means that no EL2521-0025-**1018** should be built into this machine as a spare part (even if this nevertheless works in the vast majority of cases).

In addition, it could be the case that, due to the development accompanying production in company A, the new feature C of the EL2521-0025-1019 (for example, an improved analog filter or an additional process data for the diagnosis) is discovered and used without in-house consultation. The previous stock of spare part devices are then no longer to be used for the new configuration “B2.tsm” created in this way. If series machine production is established, the scan should only be performed for informative purposes for comparison with a defined initial configuration. Changes are to be made with care!

If an EtherCAT device was created in the configuration (manually or through a scan), the I/O field can be scanned for devices/slaves.



Fig. 57: Scan query after automatic creation of an EtherCAT device (left: TwinCAT 2; right: TwinCAT 3)

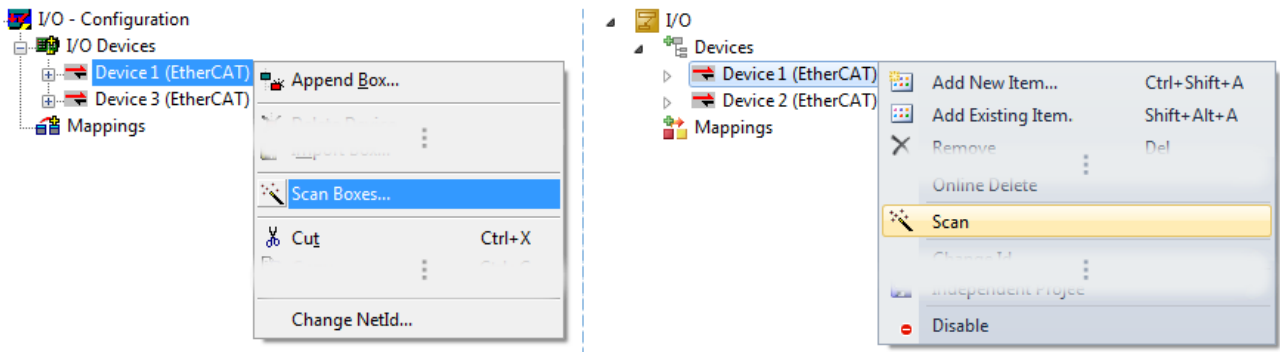

Fig. 58: Manual triggering of a device scan on a specified EtherCAT device (left: TwinCAT 2; right: TwinCAT 3)

In the System Manager (TwinCAT 2) or the User Interface (TwinCAT 3) the scan process can be monitored via the progress bar at the bottom in the status bar.



Fig. 59: Scan progress exemplarily by TwinCAT 2

The configuration is established and can then be switched to online state (OPERATIONAL).



Fig. 60: Config/FreeRun query (left: TwinCAT 2; right: TwinCAT 3)

In Config/FreeRun mode the System Manager display alternates between blue and red, and the EtherCAT device continues to operate with the idling cycle time of 4 ms (default setting), even without active task (NC, PLC).



Fig. 61: Displaying of “Free Run” and “Config Mode” toggling right below in the status bar



Fig. 62: TwinCAT can also be switched to this state by using a button (left: TwinCAT 2; right: TwinCAT 3)

The EtherCAT system should then be in a functional cyclic state, as shown in Fig. *Online display example*.

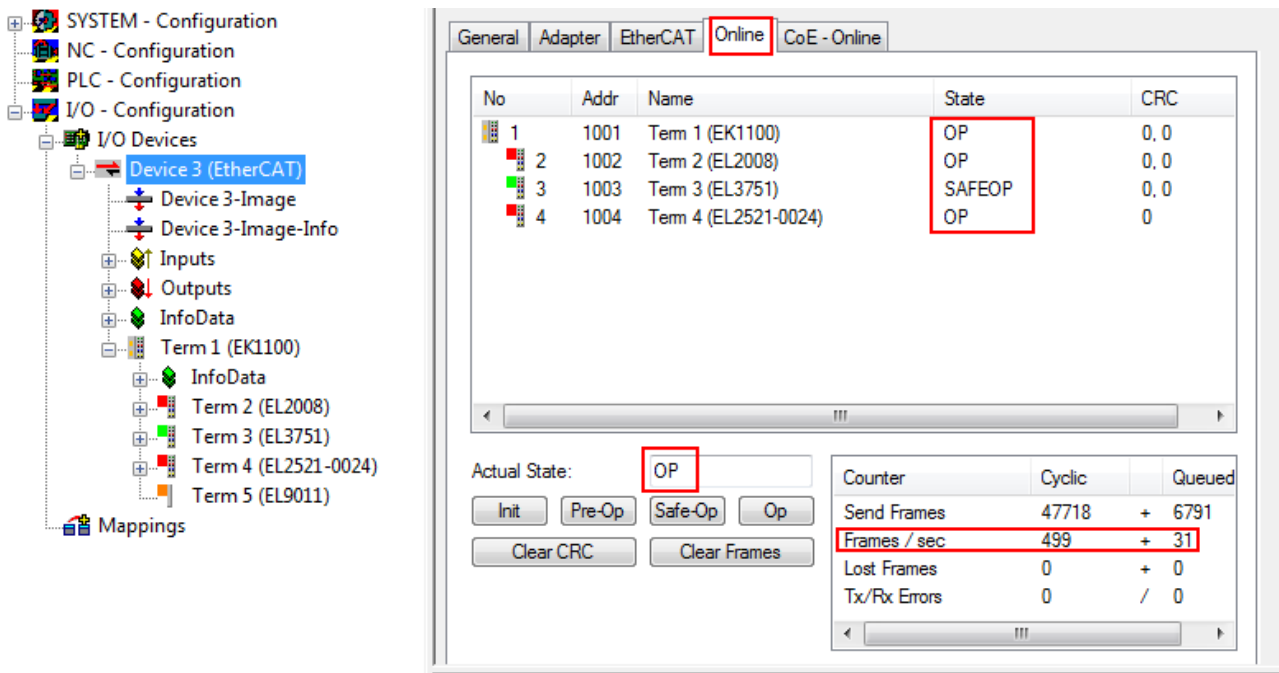

Fig. 63: Online display example

Please note:

- all slaves should be in OP state
- the EtherCAT master should be in “Actual State” OP
- “frames/sec” should match the cycle time taking into account the sent number of frames
- no excessive “LostFrames” or CRC errors should occur

The configuration is now complete. It can be modified as described under manual procedure.

Troubleshooting

Various effects may occur during scanning.

- An **unknown device** is detected, i.e. an EtherCAT slave for which no ESI XML description is available. In this case the System Manager offers to read any ESI that may be stored in the device. This case is described in the chapter “Notes regarding ESI device description”.

- **Device are not detected properly**

Possible reasons include:

- faulty data links, resulting in data loss during the scan
- slave has invalid device description

The connections and devices should be checked in a targeted manner, e.g. via the emergency scan.

Then re-run the scan.

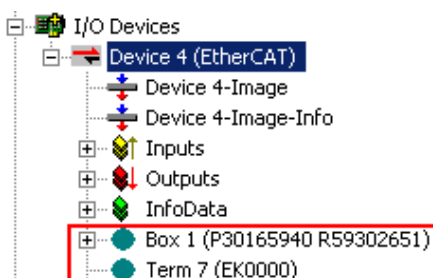

Fig. 64: Faulty identification

In the System Manager such devices may be set up as EK0000 or unknown devices. Operation is not possible or meaningful.

Scan over existing Configuration

NOTE

Change of the configuration after comparison

With this scan (TwinCAT 2.11 or 3.1) only the device properties vendor (manufacturer), device name and revision are compared at present! A “ChangeTo” or “Copy” should only be carried out with care, taking into consideration the Beckhoff IO compatibility rule (see above). The device configuration is then replaced by the revision found; this can affect the supported process data and functions.

If a scan is initiated for an existing configuration, the actual I/O environment may match the configuration exactly or it may differ. This enables the configuration to be compared.



Fig. 65: Identical configuration (left: TwinCAT 2; right: TwinCAT 3)

If differences are detected, they are shown in the correction dialog, so that the user can modify the configuration as required.

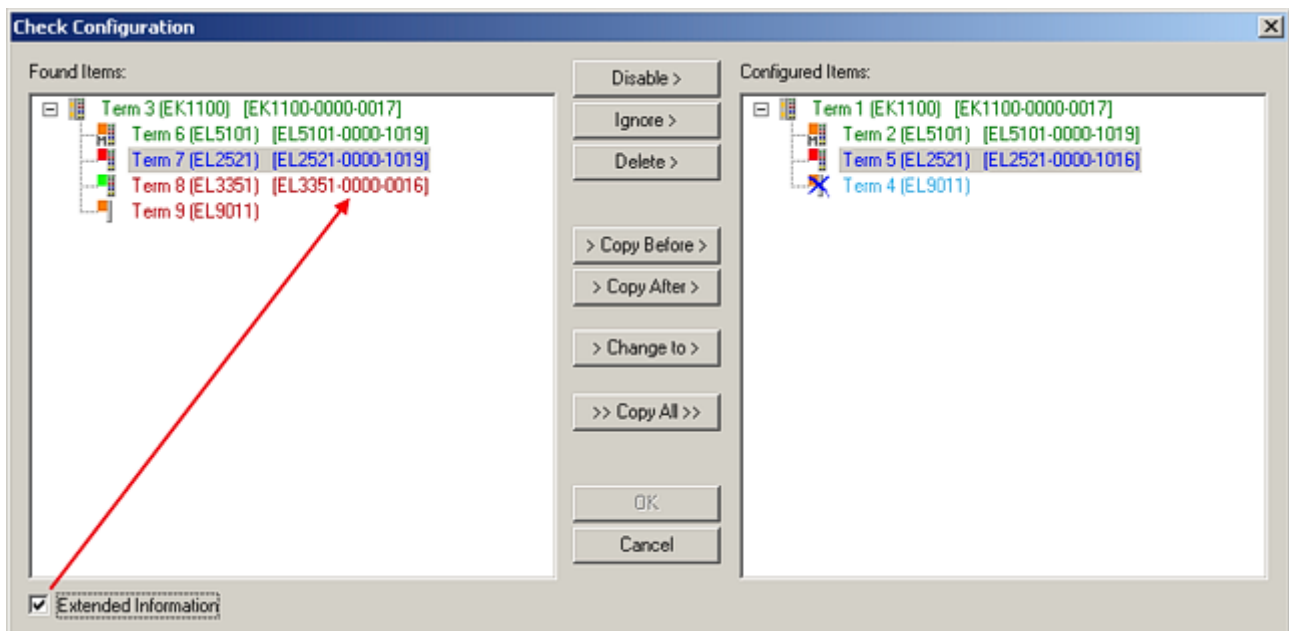

Fig. 66: Correction dialog

It is advisable to tick the “Extended Information” check box to reveal differences in the revision.

Color	Explanation
green	This EtherCAT slave matches the entry on the other side. Both type and revision match.
blue	This EtherCAT slave is present on the other side, but in a different revision. This other revision can have other default values for the process data as well as other/additional functions. If the found revision is higher than the configured revision, the slave may be used provided compatibility issues are taken into account. If the found revision is lower than the configured revision, it is likely that the slave cannot be used. The found device may not support all functions that the master expects based on the higher revision number.
light blue	This EtherCAT slave is ignored ("Ignore" button)
red	<ul style="list-style-type: none"> This EtherCAT slave is not present on the other side. It is present, but in a different revision, which also differs in its properties from the one specified. The compatibility principle then also applies here: if the found revision is higher than the configured revision, use is possible provided compatibility issues are taken into account, since the successor devices should support the functions of the predecessor devices. If the found revision is lower than the configured revision, it is likely that the slave cannot be used. The found device may not support all functions that the master expects based on the higher revision number.

i Device selection based on revision, compatibility

The ESI description also defines the process image, the communication type between master and slave/device and the device functions, if applicable. The physical device (firmware, if available) has to support the communication queries/settings of the master. This is backward compatible, i.e. newer devices (higher revision) should be supported if the EtherCAT master addresses them as an older revision. The following compatibility rule of thumb is to be assumed for Beckhoff EtherCAT Terminals/ Boxes/ EJ-modules:

device revision in the system >= device revision in the configuration

This also enables subsequent replacement of devices without changing the configuration (different specifications are possible for drives).

Example

If an EL2521-0025-**1018** is specified in the configuration, an EL2521-0025-**1018** or higher (**-1019**, **-1020**) can be used in practice.

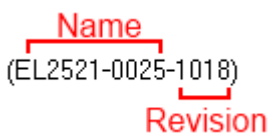

Fig. 67: Name/revision of the terminal

If current ESI descriptions are available in the TwinCAT system, the last revision offered in the selection dialog matches the Beckhoff state of production. It is recommended to use the last device revision when creating a new configuration, if current Beckhoff devices are used in the real application. Older revisions should only be used if older devices from stock are to be used in the application.

In this case the process image of the device is shown in the configuration tree and can be parameterized as follows: linking with the task, CoE/DC settings, plug-in definition, startup settings, ...

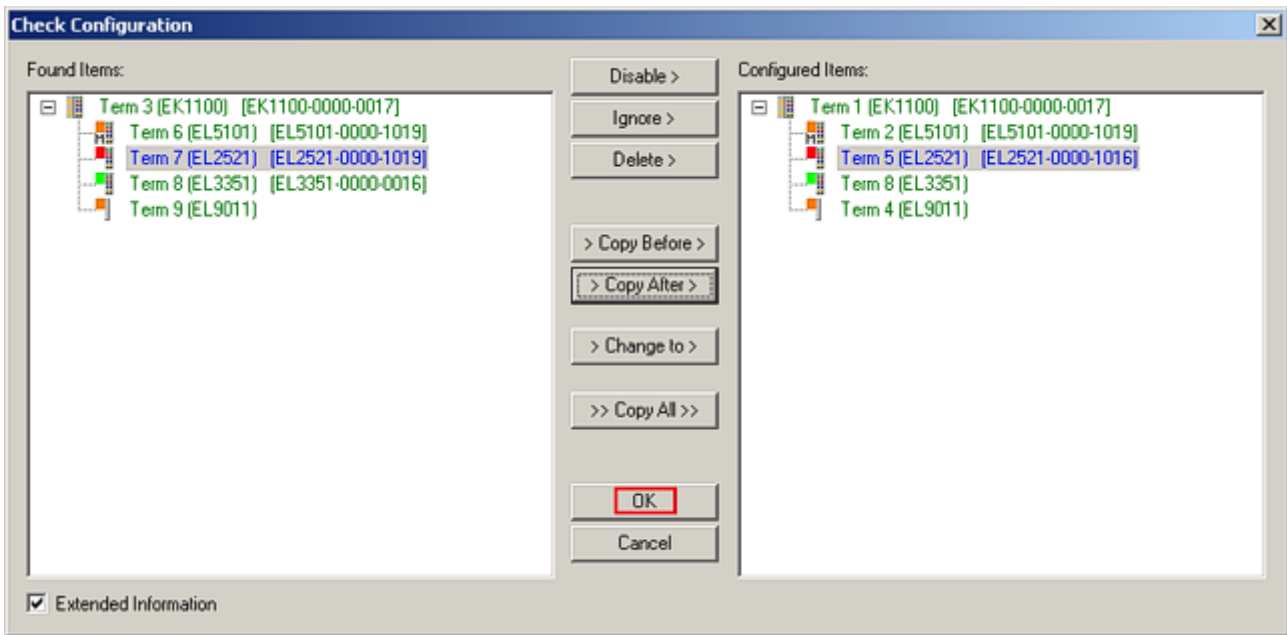

Fig. 68: Correction dialog with modifications

Once all modifications have been saved or accepted, click “OK” to transfer them to the real *.tsm configuration.

Change to Compatible Type

TwinCAT offers a function *Change to Compatible Type...* for the exchange of a device whilst retaining the links in the task.

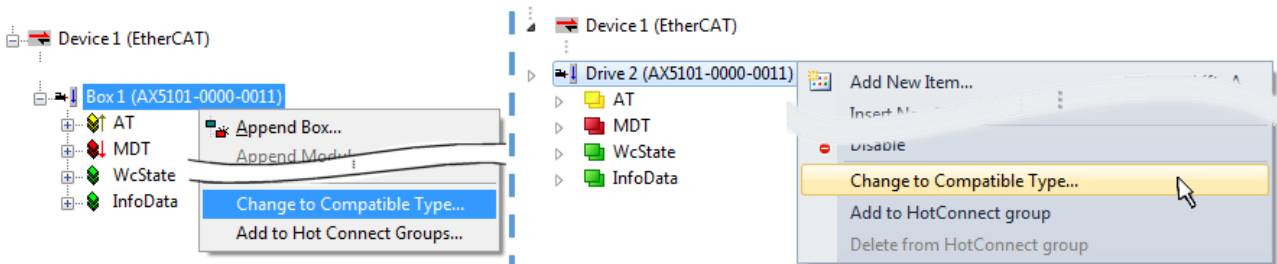

Fig. 69: Dialog “Change to Compatible Type...” (left: TwinCAT 2; right: TwinCAT 3)

This function is preferably to be used on AX5000 devices.

Change to Alternative Type

The TwinCAT System Manager offers a function for the exchange of a device: Change to Alternative Type

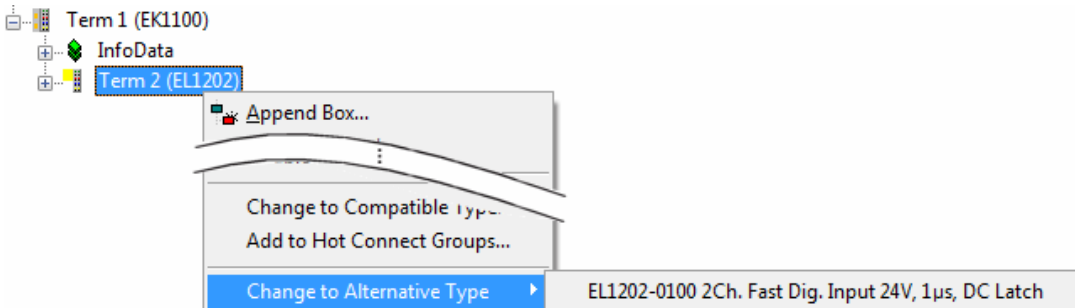

Fig. 70: TwinCAT 2 Dialog Change to Alternative Type

If called, the System Manager searches in the procured device ESI (in this example: EL 1202-0000) for details of compatible devices contained there. The configuration is changed and the ESI-EEPROM is overwritten at the same time – therefore this process is possible only in the online state (ConfigMode).

5.2.7 EtherCAT subscriber configuration

In the left-hand window of the TwinCAT 2 System Manager or the Solution Explorer of the TwinCAT 3 Development Environment respectively, click on the element of the terminal within the tree you wish to configure (in the example: EL3751 Terminal 3).

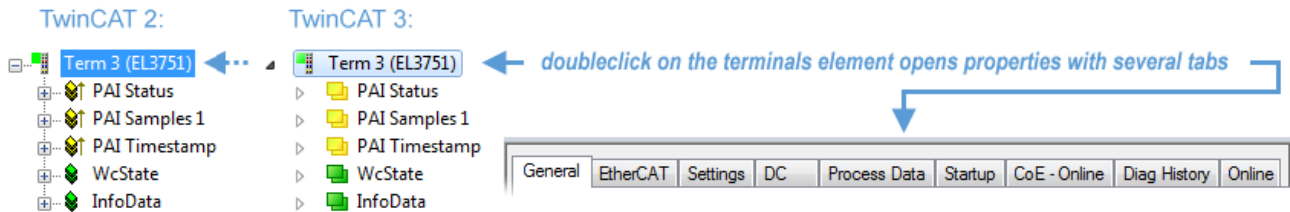

Fig. 71: Branch element as terminal EL3751

In the right-hand window of the TwinCAT System Manager (TwinCAT 2) or the Development Environment (TwinCAT 3), various tabs are now available for configuring the terminal. And yet the dimension of complexity of a subscriber determines which tabs are provided. Thus as illustrated in the example above the terminal EL3751 provides many setup options and also a respective number of tabs are available. On the contrary by the terminal EL1004 for example the tabs “General”, “EtherCAT”, “Process Data” and “Online” are available only. Several terminals, as for instance the EL6695 provide special functions by a tab with its own terminal name, so “EL6695” in this case. A specific tab “Settings” by terminals with a wide range of setup options will be provided also (e.g. EL3751).

“General” tab

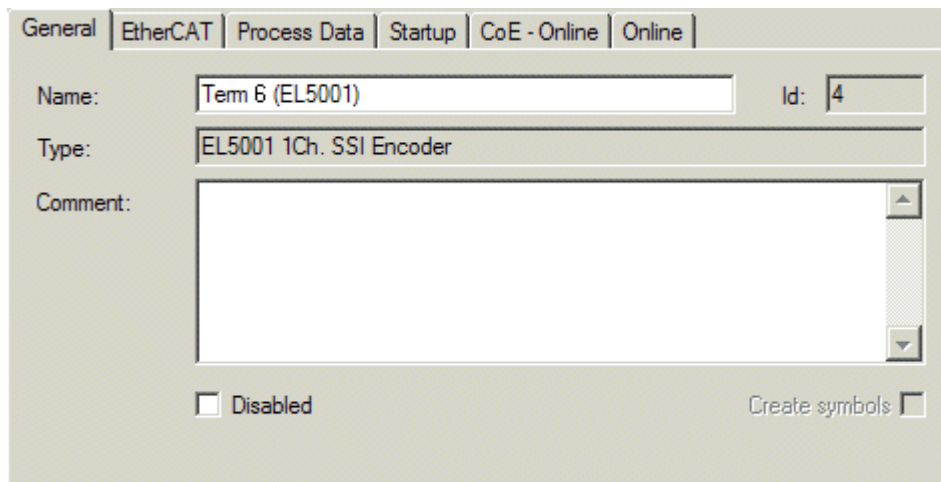

Fig. 72: “General” tab

Name	Name of the EtherCAT device
Id	Number of the EtherCAT device
Type	EtherCAT device type
Comment	Here you can add a comment (e.g. regarding the system).
Disabled	Here you can deactivate the EtherCAT device.
Create symbols	Access to this EtherCAT slave via ADS is only available if this control box is activated.

“EtherCAT” tab

Fig. 73: “EtherCAT” tab

Type	EtherCAT device type
Product/Revision	Product and revision number of the EtherCAT device
Auto Inc Addr.	Auto increment address of the EtherCAT device. The auto increment address can be used for addressing each EtherCAT device in the communication ring through its physical position. Auto increment addressing is used during the start-up phase when the EtherCAT master allocates addresses to the EtherCAT devices. With auto increment addressing the first EtherCAT slave in the ring has the address 0000 _{hex} . For each further slave the address is decremented by 1 (FFFF _{hex} , FFFE _{hex} etc.).
EtherCAT Addr.	Fixed address of an EtherCAT slave. This address is allocated by the EtherCAT master during the start-up phase. Tick the control box to the left of the input field in order to modify the default value.
Previous Port	Name and port of the EtherCAT device to which this device is connected. If it is possible to connect this device with another ring one without changing the order of the EtherCAT devices in the communication ring, then this combination field is activated and the EtherCAT device to which this device is to be connected can be selected.
Advanced Settings	This button opens the dialogs for advanced settings.

The link at the bottom of the tab points to the product page for this EtherCAT device on the web.

“Process Data” tab

Indicates the configuration of the process data. The input and output data of the EtherCAT slave are represented as CANopen process data objects (**P**rocess **D**ata **O**bjects, PDOs). The user can select a PDO via PDO assignment and modify the content of the individual PDO via this dialog, if the EtherCAT slave supports this function.

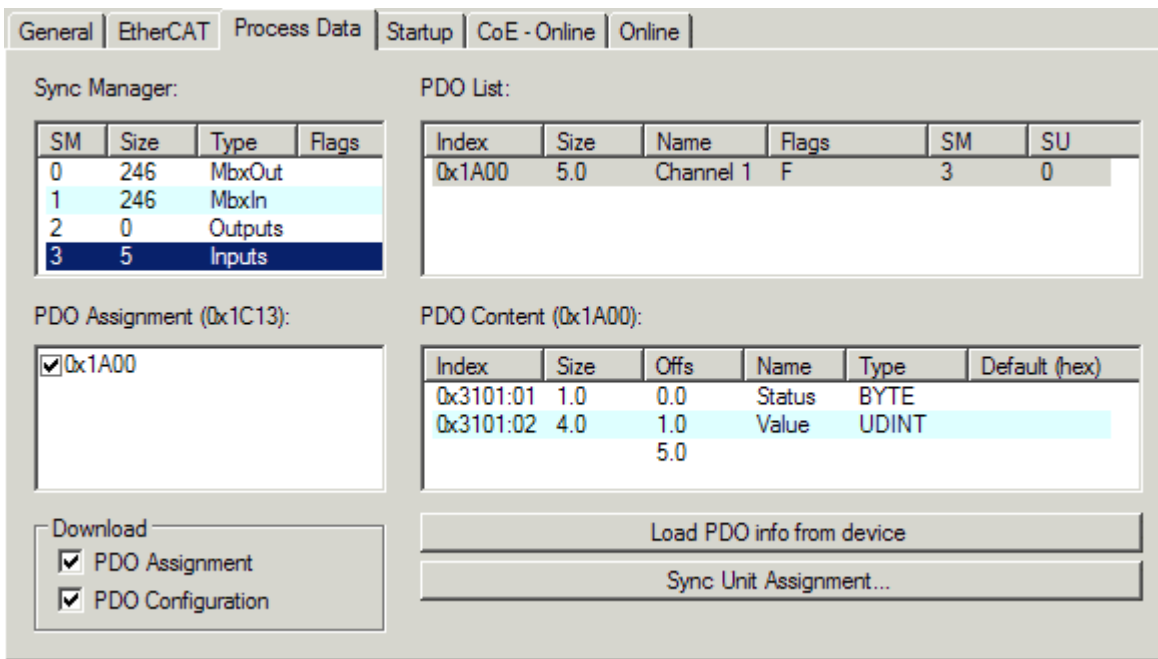

Fig. 74: "Process Data" tab

The process data (PDOs) transferred by an EtherCAT slave during each cycle are user data which the application expects to be updated cyclically or which are sent to the slave. To this end the EtherCAT master (Beckhoff TwinCAT) parameterizes each EtherCAT slave during the start-up phase to define which process data (size in bits/bytes, source location, transmission type) it wants to transfer to or from this slave. Incorrect configuration can prevent successful start-up of the slave.

For Beckhoff EtherCAT EL, ES, EM, EJ and EP slaves the following applies in general:

- The input/output process data supported by the device are defined by the manufacturer in the ESI/XML description. The TwinCAT EtherCAT Master uses the ESI description to configure the slave correctly.
- The process data can be modified in the System Manager. See the device documentation. Examples of modifications include: mask out a channel, displaying additional cyclic information, 16-bit display instead of 8-bit data size, etc.
- In so-called "intelligent" EtherCAT devices the process data information is also stored in the CoE directory. Any changes in the CoE directory that lead to different PDO settings prevent successful startup of the slave. It is not advisable to deviate from the designated process data, because the device firmware (if available) is adapted to these PDO combinations.

If the device documentation allows modification of process data, proceed as follows (see Figure *Configuring the process data*).

- A: select the device to configure
- B: in the "Process Data" tab select Input or Output under SyncManager (C)
- D: the PDOs can be selected or deselected
- H: the new process data are visible as linkable variables in the System Manager
The new process data are active once the configuration has been activated and TwinCAT has been restarted (or the EtherCAT master has been restarted)
- E: if a slave supports this, Input and Output PDO can be modified simultaneously by selecting a so-called PDO record ("predefined PDO settings").

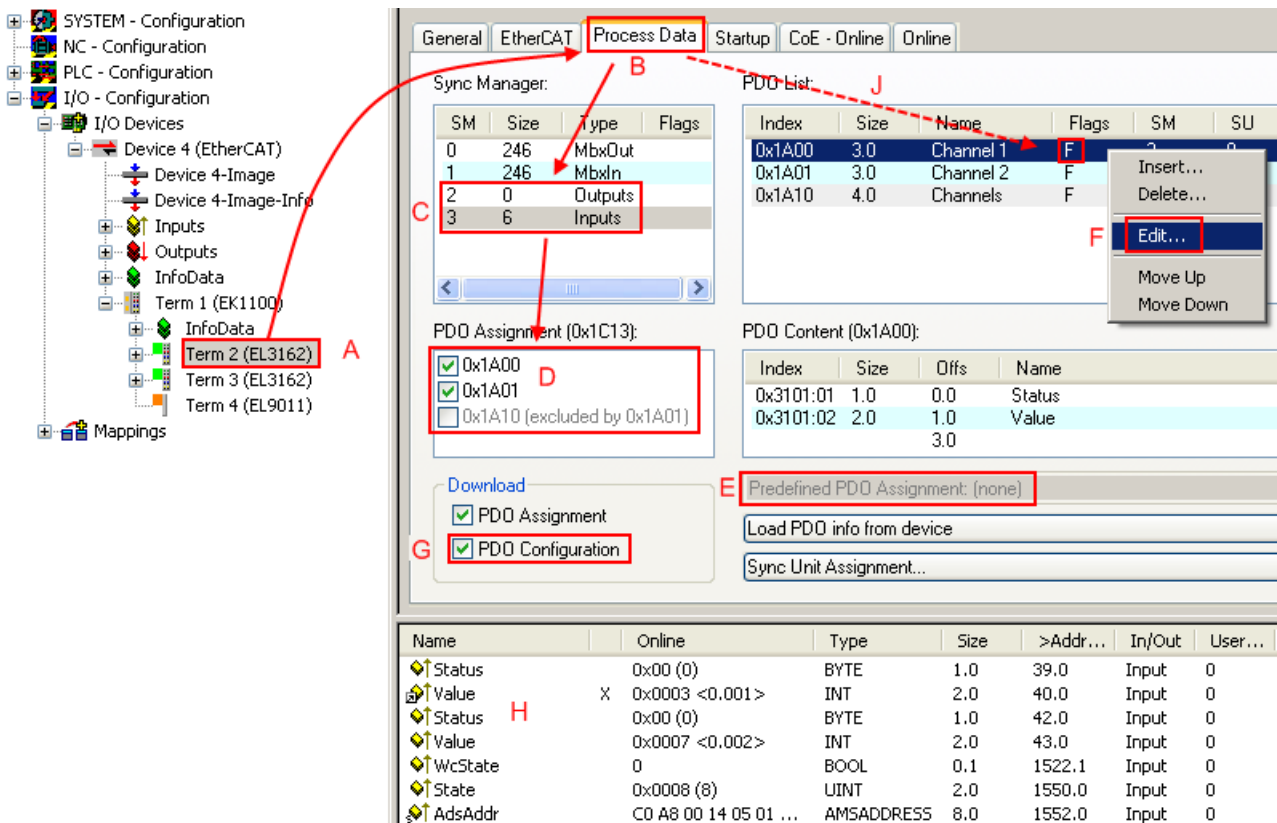

Fig. 75: Configuring the process data

i Manual modification of the process data

According to the ESI description, a PDO can be identified as “fixed” with the flag “F” in the PDO overview (Fig. *Configuring the process data*, J). The configuration of such PDOs cannot be changed, even if TwinCAT offers the associated dialog (“Edit”). In particular, CoE content cannot be displayed as cyclic process data. This generally also applies in cases where a device supports download of the PDO configuration, “G”. In case of incorrect configuration the EtherCAT slave usually refuses to start and change to OP state. The System Manager displays an “invalid SM cfg” logger message: This error message (“invalid SM IN cfg” or “invalid SM OUT cfg”) also indicates the reason for the failed start.

A detailed description [▶ 67] can be found at the end of this section.

“Startup” tab

The *Startup* tab is displayed if the EtherCAT slave has a mailbox and supports the *CANopen over EtherCAT* (CoE) or *Servo drive over EtherCAT* protocol. This tab indicates which download requests are sent to the mailbox during startup. It is also possible to add new mailbox requests to the list display. The download requests are sent to the slave in the same order as they are shown in the list.

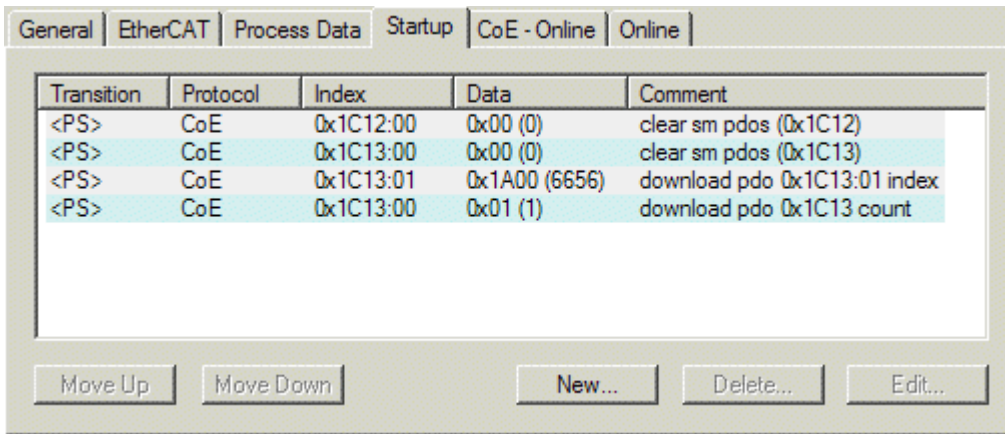

Fig. 76: “Startup” tab

Column	Description
Transition	Transition to which the request is sent. This can either be <ul style="list-style-type: none"> • the transition from pre-operational to safe-operational (PS), or • the transition from safe-operational to operational (SO). If the transition is enclosed in “<>” (e.g. <PS>), the mailbox request is fixed and cannot be modified or deleted by the user.
Protocol	Type of mailbox protocol
Index	Index of the object
Data	Date on which this object is to be downloaded.
Comment	Description of the request to be sent to the mailbox

- Move Up** This button moves the selected request up by one position in the list.
- Move Down** This button moves the selected request down by one position in the list.
- New** This button adds a new mailbox download request to be sent during startup.
- Delete** This button deletes the selected entry.
- Edit** This button edits an existing request.

“CoE - Online” tab

The additional *CoE - Online* tab is displayed if the EtherCAT slave supports the *CANopen over EtherCAT* (CoE) protocol. This dialog lists the content of the object list of the slave (SDO upload) and enables the user to modify the content of an object from this list. Details for the objects of the individual EtherCAT devices can be found in the device-specific object descriptions.

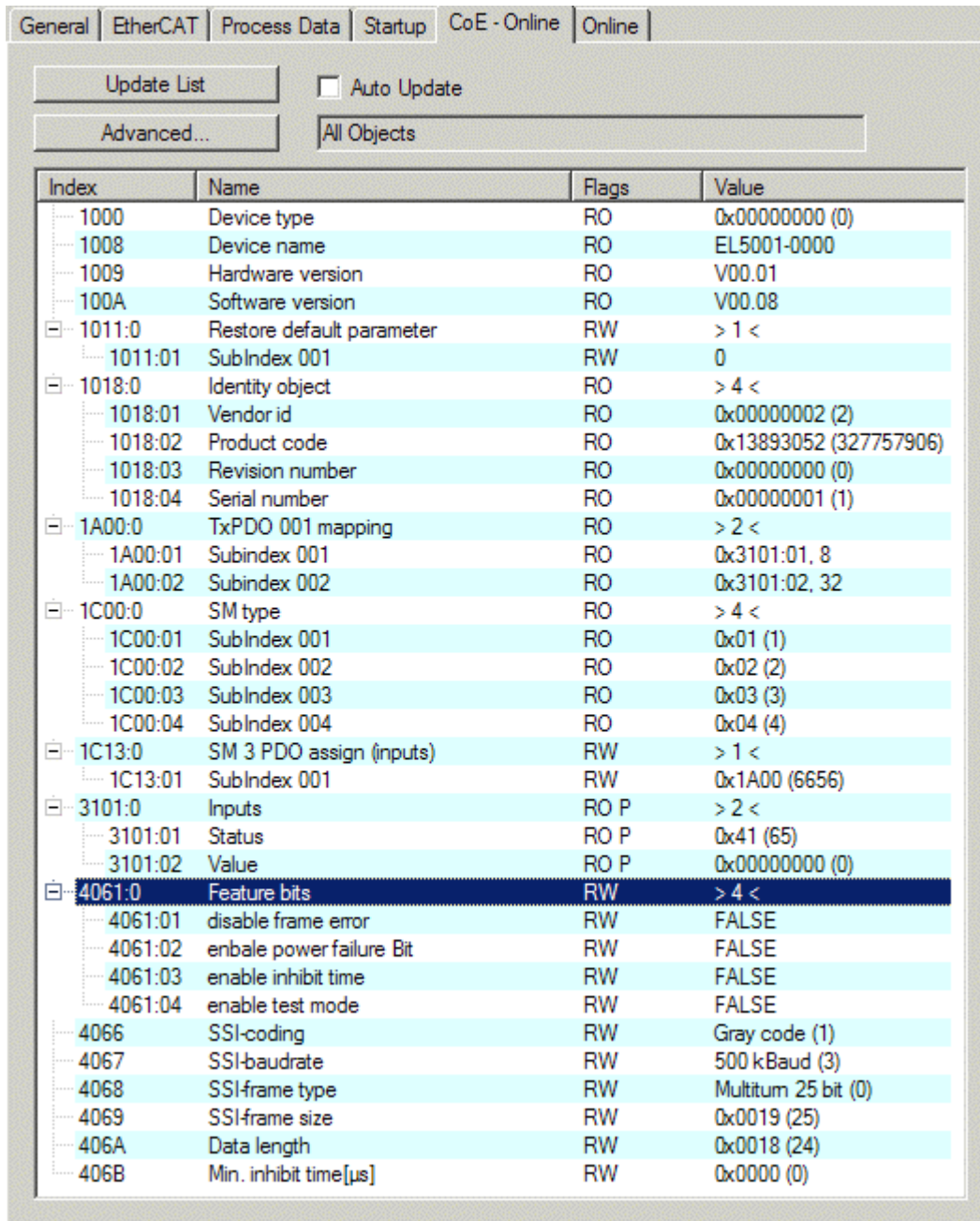

Fig. 77: "CoE - Online" tab

Object list display

Column	Description
Index	Index and sub-index of the object
Name	Name of the object
Flags	RW The object can be read, and data can be written to the object (read/write)
	RO The object can be read, but no data can be written to the object (read only)
	P An additional P identifies the object as a process data object.
Value	Value of the object

Update List The *Update list* button updates all objects in the displayed list

Auto Update If this check box is selected, the content of the objects is updated automatically.

Advanced The *Advanced* button opens the *Advanced Settings* dialog. Here you can specify which objects are displayed in the list.

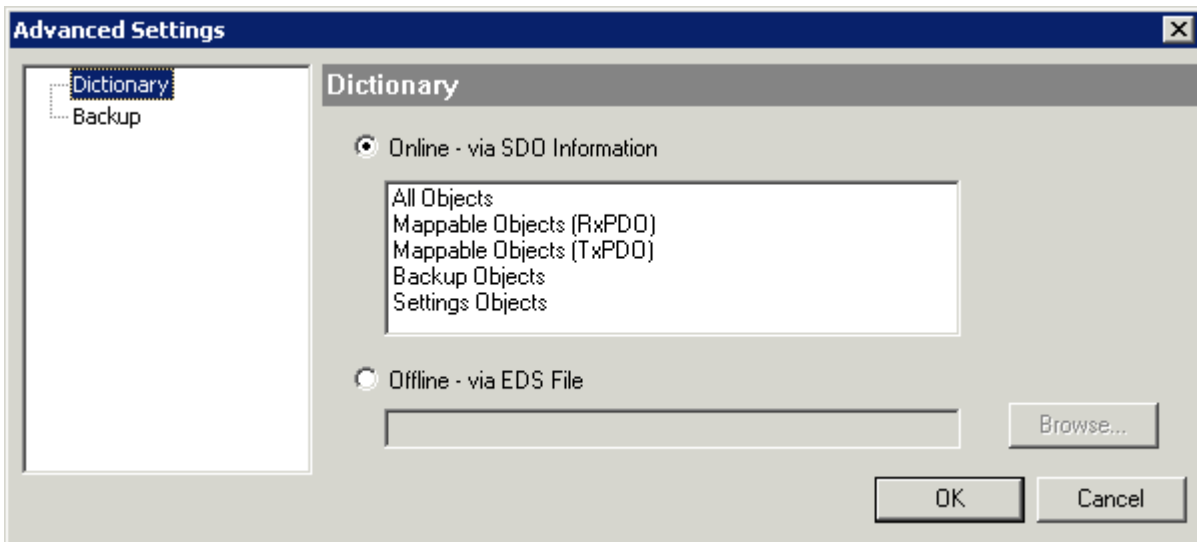

Fig. 78: Dialog “Advanced settings”

Online - via SDO Information If this option button is selected, the list of the objects included in the object list of the slave is uploaded from the slave via SDO information. The list below can be used to specify which object types are to be uploaded.

Offline - via EDS File If this option button is selected, the list of the objects included in the object list is read from an EDS file provided by the user.

“Online” tab

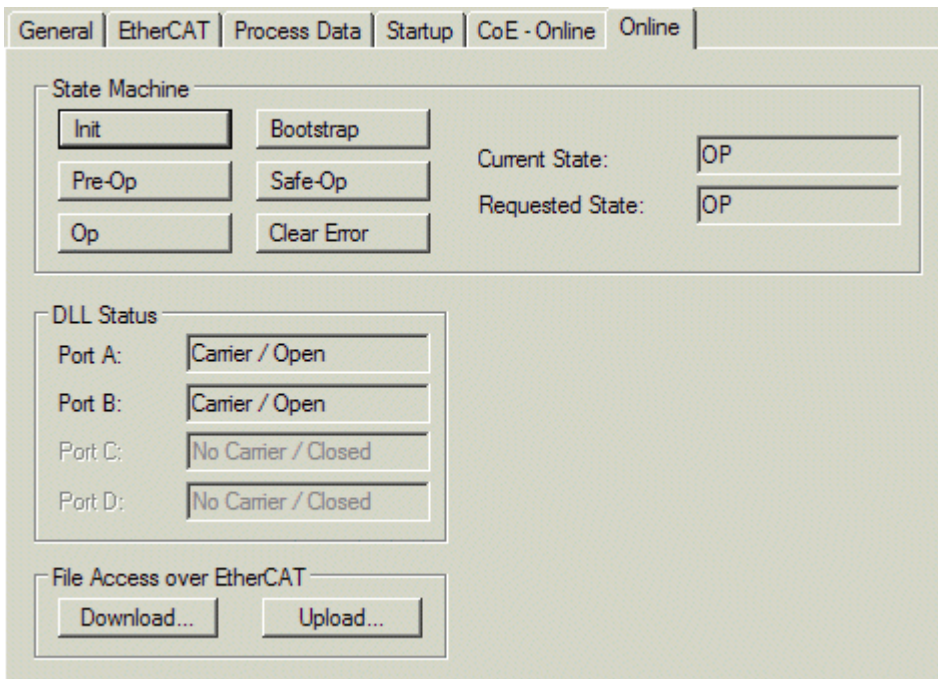

Fig. 79: “Online” tab

State Machine

- Init** This button attempts to set the EtherCAT device to the *Init* state.
- Pre-Op** This button attempts to set the EtherCAT device to the *pre-operational* state.
- Op** This button attempts to set the EtherCAT device to the *operational* state.
- Bootstrap** This button attempts to set the EtherCAT device to the *Bootstrap* state.
- Safe-Op** This button attempts to set the EtherCAT device to the *safe-operational* state.
- Clear Error** This button attempts to delete the fault display. If an EtherCAT slave fails during change of state it sets an error flag.

Example: An EtherCAT slave is in PREOP state (pre-operational). The master now requests the SAFEOP state (safe-operational). If the slave fails during change of state it sets the error flag. The current state is now displayed as ERR PREOP. When the *Clear Error* button is pressed the error flag is cleared, and the current state is displayed as PREOP again.
- Current State** Indicates the current state of the EtherCAT device.
- Requested State** Indicates the state requested for the EtherCAT device.

DLL Status

Indicates the DLL status (data link layer status) of the individual ports of the EtherCAT slave. The DLL status can have four different states:

Status	Description
No Carrier / Open	No carrier signal is available at the port, but the port is open.
No Carrier / Closed	No carrier signal is available at the port, and the port is closed.
Carrier / Open	A carrier signal is available at the port, and the port is open.
Carrier / Closed	A carrier signal is available at the port, but the port is closed.

File Access over EtherCAT

- Download** With this button a file can be written to the EtherCAT device.
- Upload** With this button a file can be read from the EtherCAT device.

“DC” tab (Distributed Clocks)

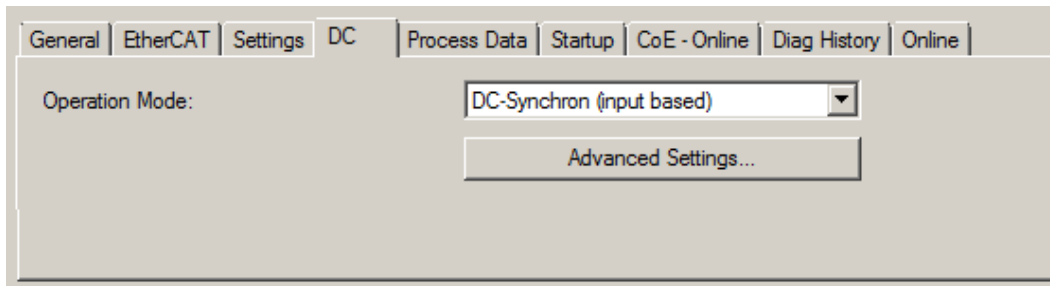

Fig. 80: “DC” tab (Distributed Clocks)

- Operation Mode** Options (optional):
 - FreeRun
 - SM-Synchron
 - DC-Synchron (Input based)
 - DC-Synchron
- Advanced Settings...** Advanced settings for readjustment of the real time determinant TwinCAT-clock

Detailed information to Distributed Clocks is specified on <http://infosys.beckhoff.com>:

Fieldbus Components → EtherCAT Terminals → EtherCAT System documentation → EtherCAT basics → Distributed Clocks

5.2.7.1 Detailed description of Process Data tab

Sync Manager

Lists the configuration of the Sync Manager (SM).

If the EtherCAT device has a mailbox, SM0 is used for the mailbox output (MbxOut) and SM1 for the mailbox input (MbxIn).

SM2 is used for the output process data (outputs) and SM3 (inputs) for the input process data.

If an input is selected, the corresponding PDO assignment is displayed in the *PDO Assignment* list below.

PDO Assignment



PDO assignment of the selected Sync Manager. All PDOs defined for this Sync Manager type are listed here:

- If the output Sync Manager (outputs) is selected in the Sync Manager list, all RxPDOs are displayed.
- If the input Sync Manager (inputs) is selected in the Sync Manager list, all TxPDOs are displayed.

The selected entries are the PDOs involved in the process data transfer. In the tree diagram of the System Manager these PDOs are displayed as variables of the EtherCAT device. The name of the variable is identical to the *Name* parameter of the PDO, as displayed in the PDO list. If an entry in the PDO assignment list is deactivated (not selected and greyed out), this indicates that the input is excluded from the PDO assignment. In order to be able to select a greyed out PDO, the currently selected PDO has to be deselected first.

i Activation of PDO assignment

- ✓ If you have changed the PDO assignment, in order to activate the new PDO assignment,
 - a) the EtherCAT slave has to run through the PS status transition cycle (from pre-operational to safe-operational) once (see [Online tab \[▶ 65\]](#)),
 - b) and the System Manager has to reload the EtherCAT slaves

( button for TwinCAT 2 or  button for TwinCAT 3)

PDO list

List of all PDOs supported by this EtherCAT device. The content of the selected PDOs is displayed in the *PDO Content* list. The PDO configuration can be modified by double-clicking on an entry.

Column	Description	
Index	PDO index.	
Size	Size of the PDO in bytes.	
Name	Name of the PDO. If this PDO is assigned to a Sync Manager, it appears as a variable of the slave with this parameter as the name.	
Flags	F	Fixed content: The content of this PDO is fixed and cannot be changed by the System Manager.
	M	Mandatory PDO. This PDO is mandatory and must therefore be assigned to a Sync Manager! Consequently, this PDO cannot be deleted from the <i>PDO Assignment</i> list
SM	Sync Manager to which this PDO is assigned. If this entry is empty, this PDO does not take part in the process data traffic.	
SU	Sync unit to which this PDO is assigned.	

PDO Content

Indicates the content of the PDO. If flag F (fixed content) of the PDO is not set the content can be modified.

Download

If the device is intelligent and has a mailbox, the configuration of the PDO and the PDO assignments can be downloaded to the device. This is an optional feature that is not supported by all EtherCAT slaves.

PDO Assignment

If this check box is selected, the PDO assignment that is configured in the PDO Assignment list is downloaded to the device on startup. The required commands to be sent to the device can be viewed in the [Startup \[▶ 62\]](#) tab.

PDO Configuration

If this check box is selected, the configuration of the respective PDOs (as shown in the PDO list and the PDO Content display) is downloaded to the EtherCAT slave.

5.3 Process data and operation modes

5.3.1 Parameterization

An ELX315x/EPX3158 is parameterized via two dialog boxes/tabs in the TwinCAT System Manager, the Process Data tab (A) for the communication-specific settings and the CoE - Online tab (B) for the settings in the slave.

SM	Size	Type	Fla...
0	128	Mbx...	
1	128	MbxIn	
2	0	Outp...	
3	8	Inputs	

Index	Size	Name	Flags	SM	SU
0x1A00	4.0	AI Standard Channel 1	F	3	0
0x1A01	2.0	AI Compact Channel 1	F		0
0x1A02	4.0	AI Standard Channel 2	F	3	0
0x1A03	2.0	AI Compact Channel 2	F		0

Index	Size	Offs	Name	Type	Default
0x6000...	0.1	0.0	Status_Underrange	BIT	
0x6000...	0.1	0.1	Status_Overrange	BIT	
0x6000...	0.2	0.2	Status_Limit 1	BIT2	
0x6000...	0.2	0.4	Status_Limit 2	BIT2	

Name	Online	Type	Size	>Ad...	In/O...	User...	Linked to
AI Standard Channel 1	Status 0x0000 (0)	Status_A...	2.0	39.0	Input	0	
AI Standard Channel 2	Value 6968	INT	2.0	41.0	Input	0	
WcState	Status 0x0041 (65)	Status_A...	2.0	43.0	Input	0	
InfoData	Value -7624	INT	2.0	45.0	Input	0	

Fig. 81: Parameterization taking the ELX3152 as an example

- Changes to the process data-specific settings are generally only effective after a restart of the EtherCAT master:
 - restart TwinCAT in RUN or CONFIG mode; RELOAD in CONFIG mode
- Changes in CoE - Online
 - are in general immediately effective
 - are generally *only* stored non-volatile in the device and should therefore be entered in the CoE StartUp list. This list is processed at each EtherCAT start and the settings are loaded into the device.

5.3.2 Settings and operating modes

5.3.2.1 Presentation, index 0x80nD

The output of the measured value depends on the settings in Index 80nD:0 AI Advanced Settings Ch.n.

With Index 80nD:11 (Input Type) the input signal can be selected:

- 0...20 mA (ELX3152 only)
- 4...20 mA
- 4...20 mA NAMUR

With Index 80nD:12 (Scaler) the Range can be switched:

- Extended Range (measurement beyond the measurement value range)
- Legacy Range (measurement value range = minimum/maximum value)

The output values depending on these settings are shown in the following table.

Scaler Input Type	Extended Range			Legacy Range		Value	
	0...20 mA	4...20 mA	4...20 mA Namur	0...20 mA	4...20 mA	dez	hex
	21.474 mA	21.179 mA	-	20 mA	20 mA	32767	0x7FFF
	20 mA	20 mA	20 mA	-	-	30518	0x7736
	0 mA	4 mA	4 mA	0 mA	4 mA	0	0x0000
	-	0 mA	-	-	-	-7629	0xE233

5.3.2.2 Undershoot and overshoot of the measuring range (under-range, over-range), index 0x60n0:01, 0x60n0:02

Undershoot and overshoot of the measuring range (under-range, over-range), index [0x60n0:01](#) [[▶ 85](#)], [0x60n0:02](#) [[▶ 85](#)]

Chapter [Data stream and correction calculation](#) [[▶ 80](#)] contains a clear description of the correction calculation between the raw values and the output values if the limit ranges are exceeded.

5.3.2.3 Limit 1 and limit 2, Swap Limit Bits

Limit 1 and limit 2, index [0x80n0:13](#), [[▶ 84](#)] index [0x80n0:14](#) [[▶ 84](#)]

If the value exceeds or falls below these values, which can be entered in the indices [0x80n0:13](#) [[▶ 84](#)] and [0x80n0:14](#) [[▶ 84](#)], then the bits in the indices [0x60n0:03](#) [[▶ 85](#)] and [0x60n0:05](#) [[▶ 85](#)] are set accordingly (see example below). The indices [0x80n0:07](#) [[▶ 84](#)] or [0x80n0:08](#) [[▶ 84](#)] serve to activate the limit value monitoring.

Output limit n (2-bit):

- 0: not active
- 1: Value is smaller than the limit value
- 2: Value is larger than the limit value
- 3: Value is equal to the limit value

● Linking in the PLC with 2-bit values

i The limit information consists of 2 bits. Limitn can be linked to the PLC or a task in the System Manager.

- PLC:
IEC61131-PLC contains no 2-bit data type that can be linked with this process data directly. For transferring the limit information, define an input byte (e.g. see Fig. *Input byte definition*) and link the limit to the *VariableSizeMismatch* dialog, as described in chapter Note about the 1-byte status of earlier EtherCAT Terminals.

```
VAR
    byLimit1 AT %I*:BYTE;
END_VAR
```

Fig. 82: Input byte definition

- Additional task
2-bit variables can be created in the System Manager.

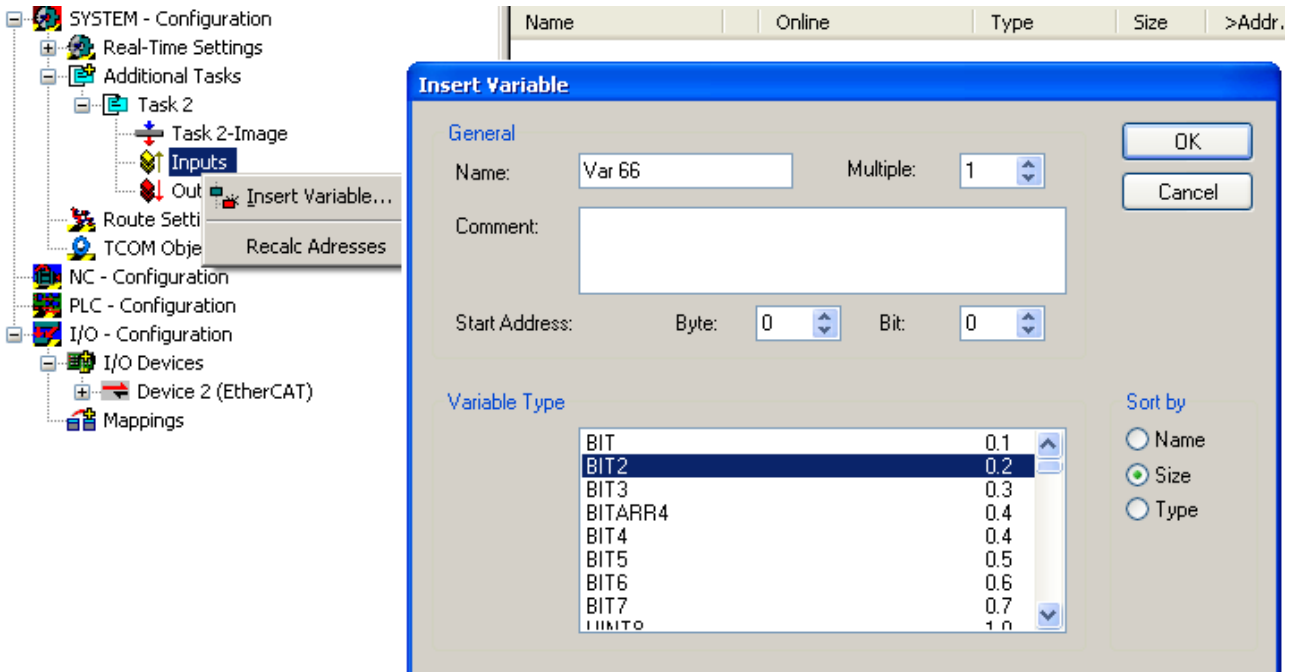

Fig. 83: Linking of 2-bit variable to additional task

Swap Limit index 0x80n0:0E [► 84]

The limit function can be inverted by *SwapLimitBits* in index 0x80n0:0E.

Output Limit n (2-bit):

SwapLimitBits setting	Value
FALSE (default setting)	<ul style="list-style-type: none"> • 0: not active • 1: value < limit value • 2: value > limit value • 3: Value is equal to the limit value
TRUE	<ul style="list-style-type: none"> • 0: not active • 1: value > limit value • 2: value < limit value • 3: Value is equal to the limit value

5.3.2.4 Operating modes

The ELX31xx/EPX3158 support three different operation modes:

- Freerun (filter on, timer interrupt)
- Synchronous (filter off, SyncManager interrupt) and
- DC (DC-Sync-Interrupt)

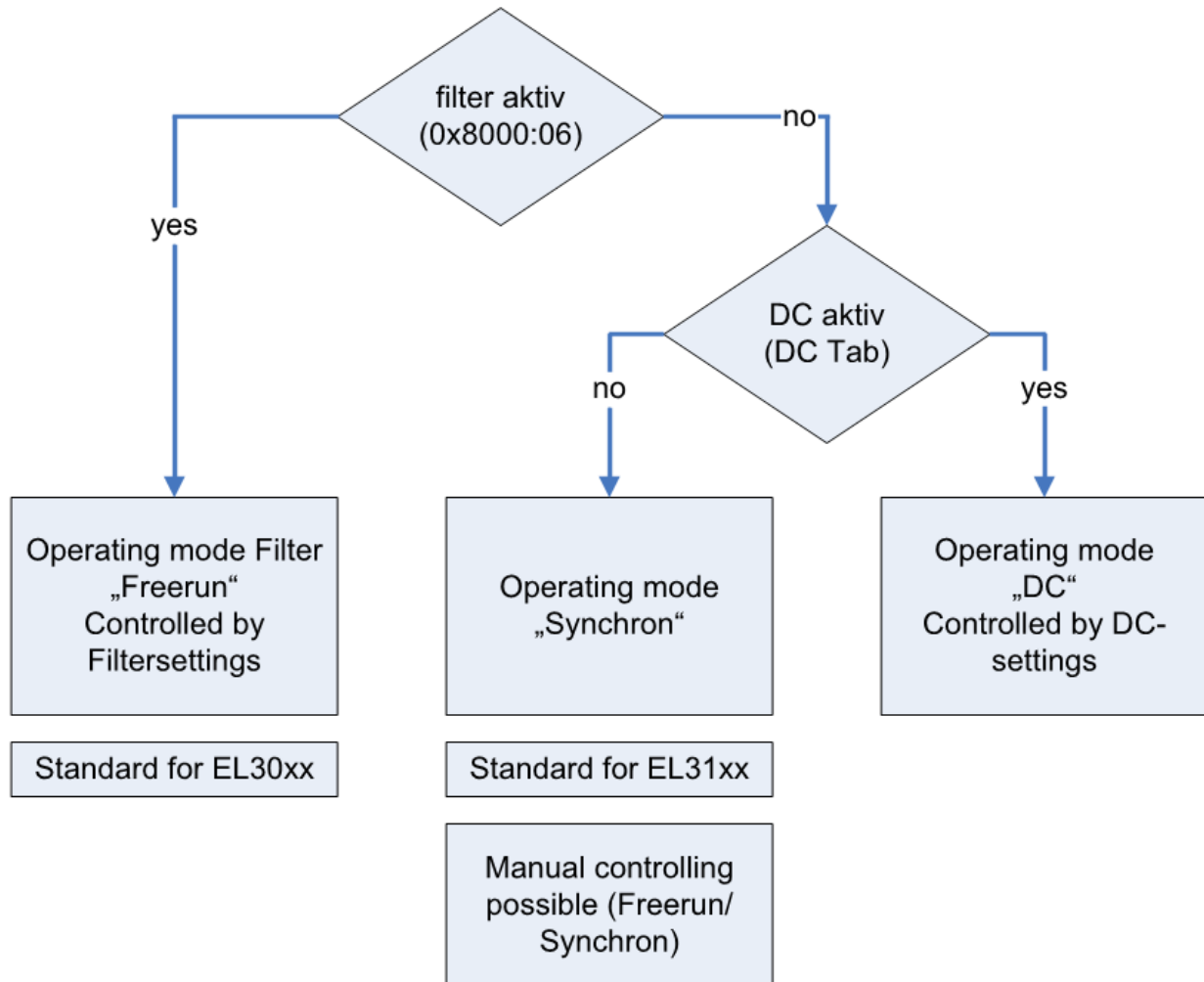

Fig. 84: Relationship of operation modes

The device switches between the Freerun (filter on) and Synchron modes by enabling/disabling the filter via the index. The terminal remains in OP mode during this process. The changeover may result in longer sampling times and step changes in the process data until the filters have assumed a steady state.

DC mode can only be used when the filters are switched off. Likewise, it is not possible to switch the filters on in DC mode. The DC mode is parameterized via the DC tab in the TwinCAT System Manager.

The operation modes of the ELX31xx/EPX3158

Mode	1 (default)	2	3	4	5	6
Filter (Index: 0x8000:06)	On (default.: 50 Hz FIR)	Off				
Distributed Clocks mode	Off					On
Synchronization mode (Index: 0x1C33:01, Bit 0+1)	0: FreeRun (default)	0: FreeRun (default)		1: Frame Triggered (SM3 inputs)		3: DC-mode
FastOp-Mode "CoE" (Index: 0x1C33:01, Bit 15)	Off (default)	Off (default)	On	Off (default)	On	Off (default) (FastOp mode not possible in DC)
StartUp entry index 0x1C33:01	0x0000	0x0000	0x8000	0x0001	0x8001	
Update rate	depends on filter setting, automatically set internally in device see following values			EtherCAT cycle time, if value does not fall below the lower setting-dependent limit. See following values for typical limit. Operation with a faster EtherCAT cycle is possible, but in that case the ELX31xx / EPX3158 no longer supplies new data in each cycle.		EtherCAT cycle time, if value does not fall below the lower setting-dependent limit.
typ. data update time ELX31xx/EPX3158	< 1 s					
Note	Once filtering is enabled, regardless of other settings "FreeRun" = On and "FastOp-Mode" = Off is set in the ELX31xx / EPX3158.					The notes on the min. EtherCAT cycle time in DC mode must be observed

i Combinations of filters, FastOp mode and Synchronization mode

Other combination options of filter, FastOp mode and Synchronization mode are expressly not recommended.

Synchron mode

In synchronous operation process data are generated frame-triggered, so that a new value is available with each PLC cycle. In the ELX31xx/EPX3158 synchron mode is used automatically (filter off, no DC). Minimum cycle time is 1 ms for standard IPCs.

DC operation

In DC mode the analog sampling is triggered by DC-interrupt. As a result, the temporal jitter between two frames is no longer important and the sampling point is the same across the entire system.

The ELX31xx/EPX3158 are to be operated in DC-Input-Based mode.

The Input-Based mode shifts the sync-interrupt in such a way that the process data are ready for collection shortly before the current process data cycle.

If the frame jitter is too large, it is possible that data may be collected twice or there may be interruptions in the transmission. In that case the jitter must be reduced by measures in the TwinCAT system or a slower cycle time must be chosen.

5.3.2.5 Filter operation (FIR and IIR), index 0x80n0:06, 0x80n0:15

Filter operation (FIR and IIR), index 0x80n00:06, 0x80n00:15

The ELX31xx/EPX3158 are equipped with a digital filter which, depending on the setting, can assume the characteristics of a finite impulse response filter (*Finite Impulse Response filter, FIR filter*) or an infinite impulse response filter (*Infinite Impulse Response filter, IIR filter*). The filter is disabled on delivery. Please observe the following note regarding activation with index 0x8000:06.

i Activation of the filter with index 0x8000:06 and setting of the filter characteristics via index 0x8000:15

The filter frequencies are set for all channels of the ELX31xx/EPX3158 centrally via index 0x8000:15 (channel 1). The corresponding indices 0x80n00:15 of the other channels have no parameterization function.

FIR filter

Parameterized via the index 0x8000:15.

The filter works as a notch filter and determines the conversion time of the device. The higher the filter frequency, the faster the conversion time. A 50 Hz and a 60 Hz filter are available. Notch filter means that the filter has zeros (notches) in the frequency response at the filter frequency and multiples thereof, i.e. it attenuates the amplitude at these frequencies.

The FIR filter operates as a non-recursive filter.

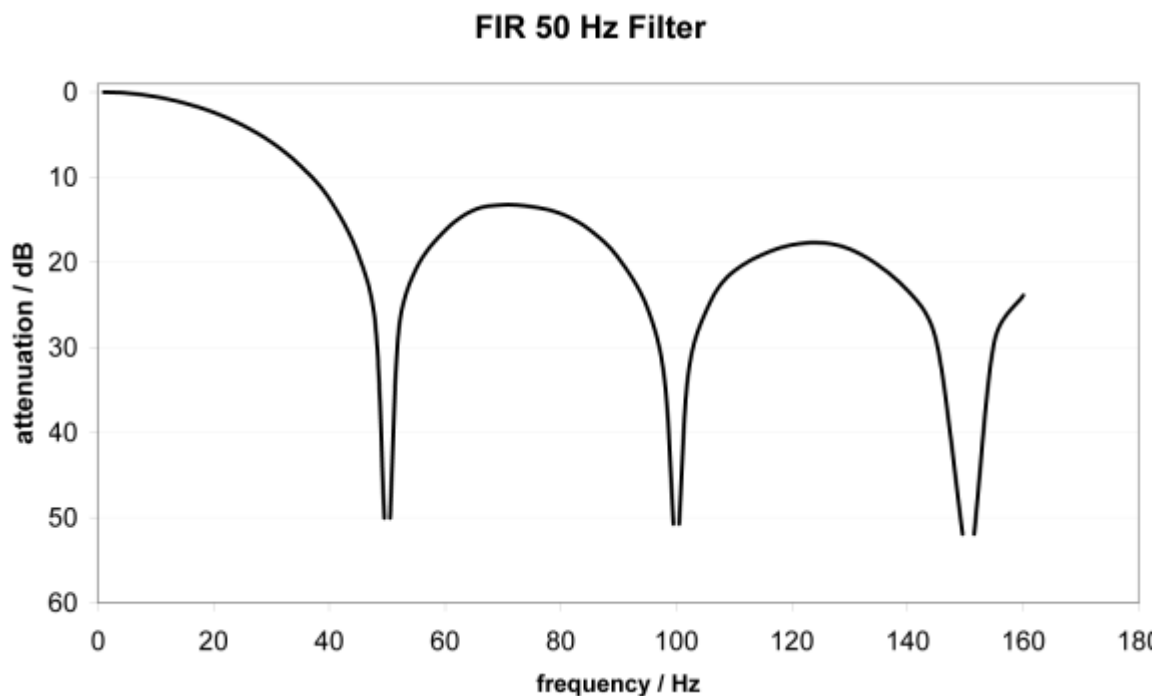

Fig. 85: Attenuation curve notch.filter at 50 Hz

Filter data FIR - Filter (one to four channel devices)			
Filter	Attenuation	Cut-off frequency (-3 dB)	Conversion time
50 Hz FIR	> 50 dB	22 Hz	625 µs
60 Hz FIR	> 45 dB	26 Hz	521 µs

IIR filter

The filter with IIR characteristic is a time-discrete, linear, time-invariant 1st order low-pass filter (-20dB/decade), which can be set in 8 levels, i.e. cut-off frequencies (level 1 = weak recursive filter, up to level 8 = strong recursive filter)

The IIR can be understood to be a sliding average value calculation after a low-pass filter.

By means of the synchronization mode *FreeRun*, the IIR filter works with an internal cycle time of 1 ms.

IIR filter	ELX31xx/EPX3158, sampling time 1 ms
	Cut-off frequency (-3 dB)
IIR 1	168 Hz
IIR 2	88 Hz
IIR 3	43 Hz
IIR 4	21 Hz
IIR 5	10.5 Hz
IIR 6	5.2 Hz
IIR 7	2.5 Hz
IIR 8	1.2 Hz

5.3.3 Process data

Table of contents
- Interpretation of Value & Status variable [▶ 74]
• Status Word [▶ 75]
• Changeover of process data sets [▶ 76]
• Note about TwinCAT 2.10 [▶ 76]
• Password protection for user calibration [▶ 77]

The ELX315x/EPX3158 offer two different process data for transmission per analog channel: the analog *Value* (16-bit) and status information (16-bit). As with individual channels, the transmission of individual status information can be deactivated in the *ProcessData* tab; these changes are effective after activation and an EtherCAT restart or reload.

There is a choice of two types of process data in the ELX315x/EPX3158:

- Standard: standard setting, *Value* (16-bit) and status information (8 or 16-bit) are transmitted per channel
- Compact: only the *Value* (16-bit) is transmitted per channel

Interpretation of Value & Status variable

Name	Online	Type	Size	>Ad...	In/O...	User...	Linked to
Status		Status_A...	2.0	53.0	Input	0	
Value		INT	2.0	55.0	Input	0	
Status		Status_A...	2.0	57.0	Input	0	
Value		INT	2.0	59.0	Input	0	
WcState		BIT	0.1	1522.2	Input	0	
InputToggle		BIT	0.1	1524.2	Input	0	
State		UINT	2.0	1552.0	Input	0	
AdsAddr		AMSAD...	8.0	1554.0	Input	0	

Fig. 86: ELX3152 default process data

The plain text display of the bit meanings of the status word is particularly helpful for commissioning, but also for linking with the PLC program.

By right-clicking on the status variable in the configuration tree (A), the structure can be opened for linking (B).

In order to be able to read the bit meanings in plain text in the online display (C), the button

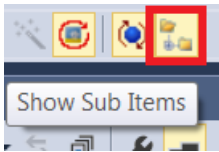

Fig. 87: Show Sub Items

can be used to show all subvariables, including the structure content of the status word, see Fig. *Display subvariables taking the ELX3152 as an example.*

Name	Online	Type	Size	>Ad...	In/O...	User...	Linked to
Term 3 (ELX3152)							
AI Standard Channel 1							
Status		Status_A...	2.0	53.0	Input	0	
Underrange		BIT	0.1	53.0	Input	0	
Overrange		BIT	0.1	53.1	Input	0	
Limit 1		BIT2	0.2	53.2	Input	0	
Limit 2		BIT2	0.2	53.4	Input	0	
Error		BIT	0.1	53.6	Input	0	
Sync error		BIT	0.1	54.5	Input	0	
TxPDO State		BIT	0.1	54.6	Input	0	
TxPDO Toggle		BIT	0.1	54.7	Input	0	
Value		INT	2.0	55.0	Input	0	
AI Standard Channel 2							
Status		Status_A...	2.0	57.0	Input	0	
Underrange		BIT	0.1	57.0	Input	0	
Overrange		BIT	0.1	57.1	Input	0	
WcState							
InfoData							

Fig. 88: Display of the subvariables using the ELX3152 as an example

Control and status word

Status word

The status word (SW) is located in the input process image, and is transmitted from the device to the controller.

Bit	SW.15	SW.14	SW.13	SW.12	SW.11	SW.10	SW.9	SW.8
Name	TxPDO Toggle	TxPDO State	Sync error	-	-	-	-	-

Bit	SW.7	SW.6	SW.5	SW.4	SW.3	SW.2	SW.1	SW.0
Name	-	ERROR	Limit 2		Limit 1		Overrange	Underrange

Legend

Bit	Name	Description
SW.15	TxPDO Toggle	1 _{bin} Toggles with each new analog process value
SW.14	TxPDO State	1 _{bin} TRUE in the case of an internal error
SW.13	Sync error	1 _{bin} TRUE (DC mode): a synchronization error occurred in the expired cycle.
SW.6	ERROR	1 _{bin} General error bit, is set together with overrange and underrange
SW.5	Limit 2	1 _{bin} See Limit
SW.4		1 _{bin}
SW.3	Limit 1	1 _{bin} See Limit
SW.2		1 _{bin}
SW.1	Overrange	1 _{bin} Analog input signal is above the upper permissible. Threshold for this device
SW.0	Underrange	1 _{bin} Analog input signal lies below the upper permissible threshold for this device

Control word

The ELX31xx/EPX3158 do not have a control word

Changeover of process data sets

The process data to be transmitted (PDO, ProcessDataObjects) can be selected by the user

- completely for all channels via the selection dialog “Predefined PDO Assignment” (all TwinCAT versions)
- selective for individual PDOs, taking into account the excluded elements.

Selection dialog *Predefined PDO Assignment*

The ELX31xx/EPX3158 do not have any Predefined PDO Assignments.

Selective PDO selection

All TwinCAT versions support the selective selection of individual PDOs, as defined in the XML description. Exclusion criteria prevent irregular combinations.

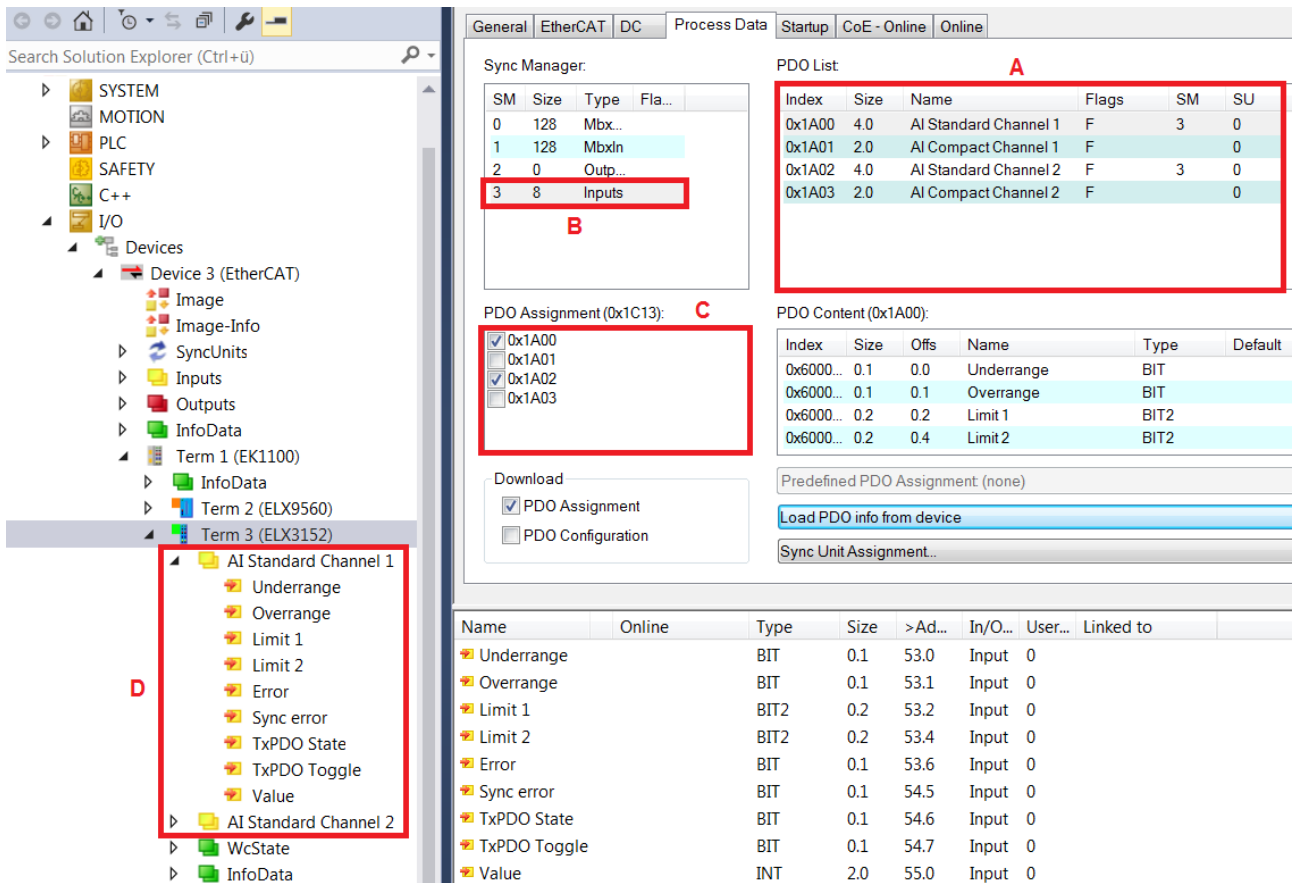

Fig. 89: Selective PDO selection taking the ELX3152 as an example

By selecting the necessary Input SyncManager in (B), the PDO assignment under (C) can be carried out manually. The process data can then be linked in the TwinCAT tree (D).

Note about TwinCAT 2.10

The structured representation of ELX31xx/EPX3158 as shown in Fig. *Selective PDO selection taking the ELX3152 as an example* is due to a corresponding interpretation of the variable names. This function does not exist in TwinCAT 2.10 yet, which is why only element-wise linking is possible there.

Name	Type	Size
Status__Underrange	BOOL	0.1
Status__Overrange	BOOL	0.1
Status__Limit 1	BIT2	0.2
Status__Limit 2	BIT2	0.2
Status__Error	BOOL	0.1
Status__Sync error	BOOL	0.1
Status__TxPDO State	BOOL	0.1
Status__TxPDO Tog...	BOOL	0.1
Value	INT	2.0
Status__Underrange	BOOL	0.1
Status__Overrange	BOOL	0.1
Status__Limit 1	BIT2	0.2
Status__Limit 2	BIT2	0.2
Status__Error	BOOL	0.1
Status__Sync error	BOOL	0.1
Status__TxPDO State	BOOL	0.1
Status__TxPDO Tog...	BOOL	0.1
Value	INT	2.0
WcState	BOOL	0.1
State	UINT	2.0
AdsAddr	AMSADDRESS	8.0

Fig. 90: Element-orientated process image under TwinCAT 2.10

Password protection for user data

Some user data are protected against unwanted or inadvertent writing by an additional password to be entered in CoE 0xF009:

- CoE write accesses by the user, PLC or startup entries in *Single* or *CompleteAccess* mode
- Overwrite the values by *RestoreDefaultParameter* Access to 0x80n0 (or 0x80nD, if available)

Address	Parameter Name	Access	Value
8000:01	Enable user scale	RW	FALSE
8000:02	Presentation	RW	Signed (0)
8000:05	Siemens bits	RW	FALSE
8000:06	Enable filter	RW	TRUE
8000:07	Enable limit 1	RW	FALSE
8000:08	Enable limit 2	RW	FALSE
8000:0A	Enable user calibration	RW	FALSE
8000:0B	Enable vendor calibration	RW	TRUE
8000:11	User scale offset	RW	0
8000:12	User scale gain	RW	65536
8000:13	Limit 1	RW	0
8000:14	Limit 2	RW	0
8000:15	Filter settings	RW	50 Hz FIR (0)
8000:17	User calibration offset	RW	0
8000:18	User calibration gain	RW	16384

Fig. 91: Password protection for the 0x8000:17 and 0x8000:18 entries (example)

The password protection applies to the following user data

Devices	Protectable CoE object
ELX3152, ELX3158, ELX3181, ELX3184, EPX3158	0x80n00:17 (User Calibration Offset) 0x80n00:18 (User Calibration Gain) 0x80nD:17 (Low Range Error) 0x80nD:18 (High Range Error)

Use of CoE 0xF009

- Entering 0x12345678 enables the password protection → Object shows "1" (enabled)
Protected objects can now no longer be changed, no error message occurs during a write access!
- Entering 0x11223344 disables password protection → Object displays "0" (disabled)



Code word Index 0xF008

This CoE object has only a vendor-specific function and is not intended for the user.

5.3.4 Data stream and measurement ranges

Data stream

The flow chart below (Fig. *Data stream of the ELX31xx/EPX3158*) shows the data stream of the ELX31xx/EPX3158 (processing of the raw data).

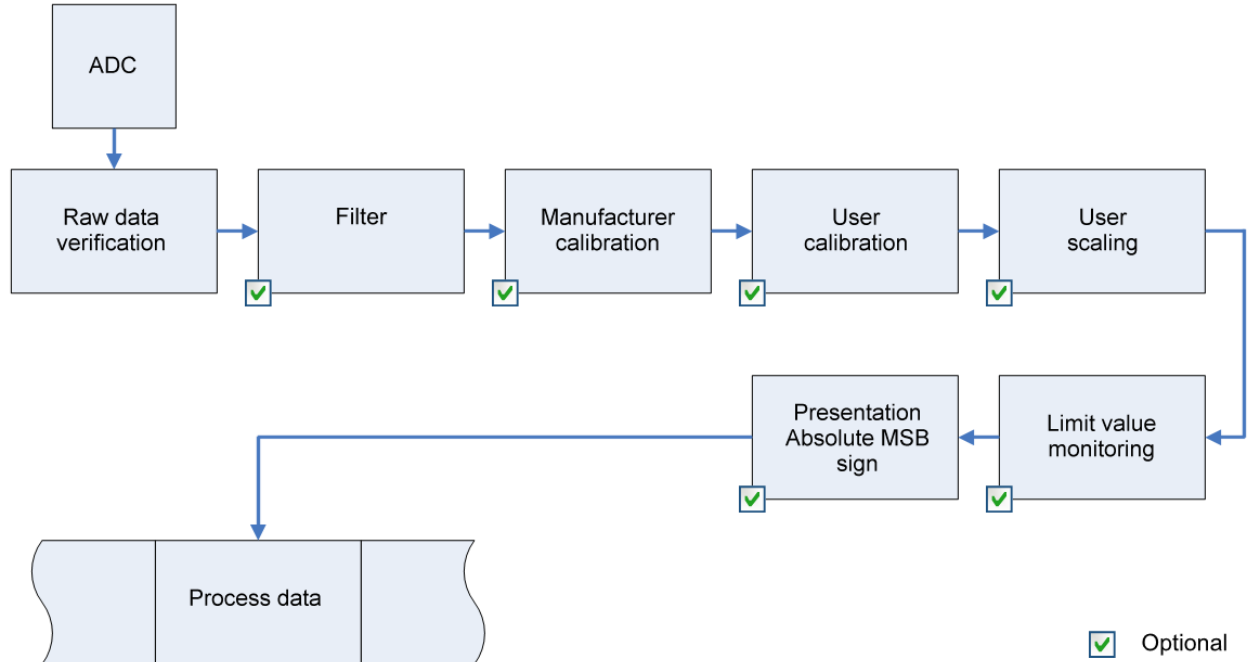

Fig. 92: Data stream of the ELX31xx/EPX3158

Calculation of process data



"Calibration"

The concept "calibration", which has historical roots at Beckhoff, is used here even if it has nothing to do with the deviation statements of a calibration certificate. Actually, this is a description of the vendor or customer calibration data/adjustment data used by the device during operation in order to maintain the assured measuring accuracy.

The ELX31xx/EPX3158 permanently record measured values and place the raw values of their A/D converter into the ADC raw value object `0x80nE:01` [► 85]. After each recording of the analog signal, the correction calculation takes place with the vendor and user calibration data as well as the user scaling, if these are activated (see fig. *Data stream of the ELX31xx/EPX3158*).

Calculation	Designation
$X_F = f(X_{ADC})$	Output value after the filter
$Y_H = (X_F - B_H) \times A_H \times 2^{-14}$	Measured value after vendor calibration,
$Y_A = (Y_H - B_A) \times A_A \times 2^{-14}$	Measured value after vendor and user calibration
$Y_S = Y_A \times A_S \times 2^{-16} + B_S$	Measured value following user scaling

Name	Name	Index
X _{ADC}	Output value of the A/D converter	0x80nE:01 [▶ 85]
X _F	Output value after the filter	-
B _H	Vendor calibration offset (not changeable)	0x80nF:01 [▶ 85]
A _H	Vendor calibration gain (not changeable)	0x80nF:02 [▶ 85]
B _A	User calibration offset (can be activated via index 0x80n0:0A [▶ 84])	0x80n0:17 [▶ 84]
A _A	User calibration gain (can be activated via index 0x80n0:0A [▶ 84])	0x80n0:18 [▶ 84]
B _S	User scaling offset (can be activated via index 0x80n00:01 [▶ 84])	0x80n00:11 [▶ 84]
A _S	User scaling gain (can be activated via index 0x80n00:01 [▶ 84])	0x80n00:12 [▶ 84]
Y _S	Process data for controller	-

● Measurement result

i The accuracy of the result may be reduced if the measured value is smaller than 32767 / 4 due to one or more multiplications.

Measurement ranges

The diagrams at the bottom show the output values of the measurement ranges and the behavior if the limit ranges are exceeded.

ELX315x/EPX3158 Scaler: Extended Range/ Legacy Range

The ELX315x/EPX3158 offer Extended Range and Legacy Range scaling (Scaler, AI Advanced settings object 0x80nD:12).

Extended Range:

This type of scaling allows the actual measuring range to be exceeded or undershot by approx. 7 %. The technically usable range is therefore -107% to +107% of the respective full scale value. Example: full scale value = 0...20 mA then the technical measuring range is approx. 0...21.4 mA.

Legacy Range:

The Legacy Range, on the other hand, represents the conventional range from -100% to + 100%. +100% corresponds to +32767
-100% corresponds to -32768.

For the Extended Range the PDO value ±30518 (0x7736) has been defined as 100% for 16 bits. As a result, the bit meaning with the (user-selected measuring range) full scale value (FSV) is as follows:



The diagrams associated with all measuring ranges are shown below:

Measuring range 0...20 mA (current loop)

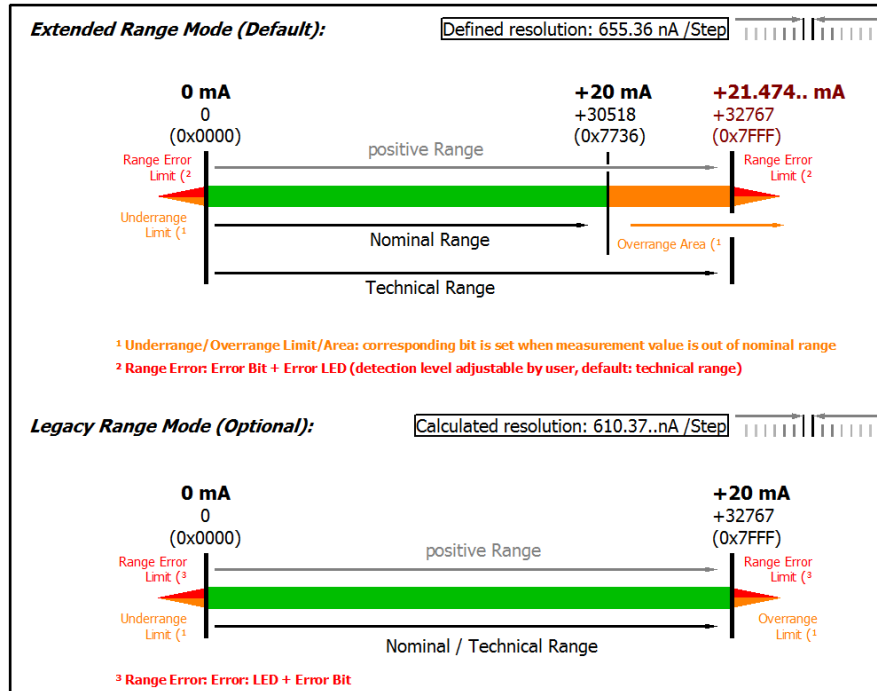

Technical note: The detection level for underrange and range error of 0 value area is located at -0.2 mA (-1% of the full scale value). This has been configured to prevent a misleading setting of the error bit. The process data value don't undercuts 0x0000 then.

Fig. 93: ELX3152 - Measuring range 0...20 mA

Measuring range 4...20 mA (current loop)

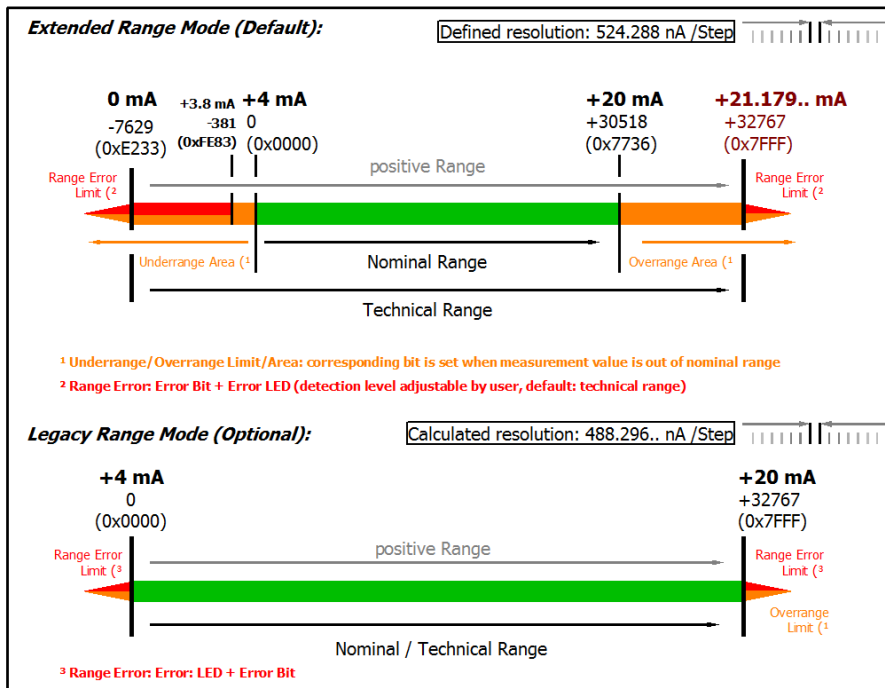

Technical note: The detection level for underrange and range error of 0 value area is located at 3.8 mA (-1% of the FSV full scale vale). This has been configured to prevent a misleading setting of the error bit.

Fig. 94: ELX315x/EPX3158 - Measuring range 4...20 mA

Measuring range 4...20 mA, NAMUR NE43 (current loop)

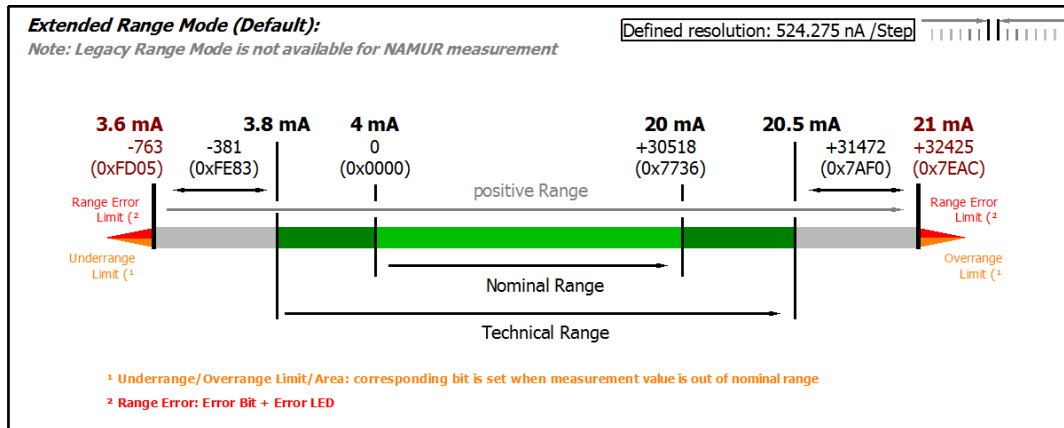

Fig. 95: ELX315x/EPX3158 - Measuring range 4...20 mA (NAMUR NE43)

Calibration

Vendor calibration, index [0x80n0:0B](#) [[▶ 84](#)]

The vendor calibration is enabled via index [0x80n0:0B](#) [[▶ 84](#)]. Parameterization takes place via the indices

- [0x80nF:01](#) [[▶ 85](#)] Vendor calibration: Offset
- [0x80nF:02](#) [[▶ 85](#)] Vendor calibration: Gain

User calibration, index [0x80n0:0A](#) [[▶ 84](#)]

The user calibration is enabled via index [0x80n0:0A](#) [[▶ 84](#)]. Parameterization takes place via the indices

- [0x80n0:17](#) [[▶ 84](#)] User calibration: Offset
- [0x80n0:18](#) [[▶ 84](#)] User calibration: Gain

User scaling, index [0x80n00:01](#) [[▶ 84](#)]

The user scaling is enabled via index [0x80n00:01](#) [[▶ 84](#)]. Parameterization takes place via the indices

- [0x80n00:11](#) [[▶ 84](#)] User scaling: offset
- [0x80n00:12](#) [[▶ 84](#)] User scaling: gain

● Vendor calibration

i The vendor reserves the right to calibrate the ELX315x/EPX3158. Therefore, the vendor calibration cannot be changed.

Also see about this

- [Configuration data](#) [[▶ 84](#)]

5.4 CoE object description and parameterization

● EtherCAT XML Device Description

i The presentation matches that of the CoE objects from the EtherCAT XML Device Description. We recommend downloading the latest XML file from the download area of the [Beckhoff website](#) and installing it according to installation instructions.

Overview

The CoE overview contains objects for different intended applications:

Object overview
<ul style="list-style-type: none"> • Restore object [▶ 83] • Configuration data [▶ 84] • Input data [▶ 85] • Output data [▶ 85] • Standard objects [▶ 85]

5.4.1 Restore object

Index 1011 Restore default parameters

Index (hex)	Name	Meaning	Data type	Flags	Default
1011:0	Restore default parameters	Restore default parameters	UINT8	RO	0x01 (1 _{dec})
1011:01	SubIndex 001	If this object is set to "0x64616F6C" in the set value dialog, all backup objects are reset to their delivery state.	UINT32	RW	0x00000000 (0 _{dec})

5.4.2 Configuration data

Index 80n0 AI settings (for $0 \leq n \leq 7$)

Index (hex)	Name	Meaning	Data type	Flags	Default
80n0:0	AI Settings	Maximum subindex	UINT8	RO	0x18 (24 _{dec})
80n00:01	Enable user scale	User scaling is active.	BOOLEAN	RW	0x00 (0 _{dec})
80n00:06	Enable filter	Enable filter, which makes PLC-cycle-synchronous data exchange unnecessary	BOOLEAN	RW	0x00 (0 _{dec})
80n00:07	Enable limit 1	Limit 1 enabled	BOOLEAN	RW	0x00 (0 _{dec})
80n00:08	Enable limit 2	Limit 2 enabled	BOOLEAN	RW	0x00 (0 _{dec})
80n0:0A	Enable user calibration	Enabling of the user calibration	BOOLEAN	RW	0x00 (0 _{dec})
80n0:0B	Enable vendor calibration	Enabling of the vendor calibration	BOOLEAN	RW	0x01 (1 _{dec})
80n0:0E	Swap limit bits	Swap limit bits	BOOLEAN	RW	0x00 (0 _{dec})
80n00:11	User scale offset	User scaling offset	INT16	RW	0x0000 (0 _{dec})
80n00:12	User scale gain	Gain of the user scaling. The gain has a fixed-point representation with the factor 2^{-16} . The value 1 corresponds to 65536 _{dec} (0x00010000) and is limited to $\pm 0x7FFFF$	INT32	RW	0x00010000 (65536 _{dec})
80n00:13	Limit 1	First limit value for setting the status bits	INT16	RW	0x0000 (0 _{dec})
80n00:14	Limit 2	Second limit value for setting the status bits	INT16	RW	0x0000 (0 _{dec})
80n00:15	Filter settings	This object determines the digital filter settings, if it is active via Enable filter (index 0x80n00:06 ▶ 84). The possible settings are sequentially numbered. 0: 50 Hz FIR 1: 60 Hz FIR 2: IIR 1 3: IIR 2 4: IIR 3 5: IIR 4 6: IIR 5 7: IIR 6 8: IIR 7 9: IIR 8	UINT16	RW	0x0000 (0 _{dec})
80n00:17	User calibration offset	User calibration offset	INT16	RW	0x0000 (0 _{dec})
80n00:18	User calibration gain	User calibration gain	INT16	RW	0x4000 (16384 _{dec})

i The filter properties are set only via index [0x8000:15 \[▶ 84\]\(#\)](#)

The filter frequencies are set for all channels of the ELX315x/EPX3158 centrally via index [0x8000:15 \[▶ 84\]\(#\)](#) (channel 1). All other corresponding indices 0x80n00:15 have no parameterization function!

Index 80nD AI Advanced settings (for $0 \leq n \leq 7$)

Index (hex)	Name	Meaning	Data type	Flags	Default	
80nD:0	AI Advanced Settings	Maximum subindex	UINT8	RO	0x12 (18 _{dez})	
80nD:11	Input Type	Measurement mode, allowed values:	UINT16	RW	0x0002 (2 _{dez})	
		0x12				0..20 mA (not for ELX3158)
		0x13				4..20 mA
80nD:12	Scaler	Scaling range, allowed values:	UINT16	RW	0x0000 (0 _{dez})	
		0x00				Extended Range
		0x03				Legacy Range (not for input type 4...20 mA NAMUR.)
80nD:17	Low Range Error	Lower threshold for setting the error bit and error led	INT32	RW	Dependent on 80nD:11	
80nD:18	High Range Error	Upper threshold for setting the error bit and error led	INT32	RW	Dependent on 80nD:11	

Index 80nE AI internal data (for $0 \leq n \leq 7$)

Index (hex)	Name	Meaning	Data type	Flags	Default
80nE:0	AI internal data	Maximum subindex	UINT8	RO	0x01 (1 _{dec})
80nE:01	ADC raw value	ADC raw value	UINT16	RO	-

Index 80nF AI vendor data (for $0 \leq n \leq 7$)

Index (hex)	Name	Meaning	Data type	Flags	Default
80nF:0	AI vendor data	Maximum subindex	UINT8	RW	0x02 (2 _{dec})
80nF:01	Calibration offset	Offset (vendor calibration)	INT16	RW	0x0000 (0 _{dec})
80nF:02	Calibration gain	Gain (vendor calibration)	INT16	RW	0x4000 (16384 _{dec})

5.4.3 Input data

Index 60n0 AI Inputs (for $0 \leq n \leq 7$)

Index (hex)	Name	Meaning	Data type	Flags	Default
60n0:0	AI inputs	Maximum subindex	INT16	RO	0x11 (17 _{dec})
60n00:01	Underrange	Value below measuring range.	BOOLEAN	RO	0x00 (0 _{dec})
60n0:02	Ovrange	Measuring range exceeded.	BOOLEAN	RO	0x00 (0 _{dec})
60n0:03	Limit 1	Limit value monitoring Limit 1 0: not active 1: value is less than limit value 1 2: value is greater than limit value 1 3: value is equal to limit value 1	BIT2	RO	0x00 (0 _{dec})
60n0:05	Limit 2	Limit value monitoring Limit 2 0: not active 1: value is less than limit value 2 2: value is greater than limit value 2 3: value is equal to limit value 2	BIT2	RO	0x00 (0 _{dec})
60n0:07	Error	The error bit is set if the data is invalid (over-range, under-range)	BOOLEAN	RO	0x00 (0 _{dec})
60n0:0E	Sync error	The Sync error bit is only required for DC mode. It indicates whether a synchronization error has occurred during the previous cycle. This means a SYNC signal was triggered in the I/O device, although no new process data were available (0=OK, 1=NOK).	BOOLEAN	RO	0x00 (0 _{dec})
60n0:0F	TxPDO State	Validity of the data of the associated TxPDO (0 = valid, 1 = invalid).	BOOLEAN	RO	0x00 (0 _{dec})
60n0:10	TxPDO Toggle	The TxPDO toggle is toggled by the slave when the data of the associated TxPDO is updated.	BOOLEAN	RO	0x00 (0 _{dec})
60n00:11	Value	Analog input date	INT16	RO	0x0000 (0 _{dec})

5.4.4 Output data

The ELX31xx/EPX3158 have no output objects

5.4.5 Standard objects

The standard objects have the same meaning for all EtherCAT slaves.

Index 1000 Device type

Index (hex)	Name	Meaning	Data type	Flags	Default
1000:0	Device type	Device type of the EtherCAT slave: the Lo-Word contains the CoE profile used (5001). The Hi-Word contains the module profile according to the modular device profile.	UINT32	RO	0x00001389 (5001 _{dec})

Index 1008 Device name

Index (hex)	Name	Meaning	Data type	Flags	Default
1008:0	Device name	Device name of the EtherCAT slave	STRING	RO	

Index 1009 Hardware version

Index (hex)	Name	Meaning	Data type	Flags	Default
1009:0	Hardware version	Hardware version of the EtherCAT slave	STRING	RO	00

Index 100A Software version

Index (hex)	Name	Meaning	Data type	Flags	Default
100A:0	Software version	Firmware version of the EtherCAT slave	STRING	RO	01

Index 1018 Identity

Index (hex)	Name	Meaning	Data type	Flags	Default
1018:0	Identity	Information for identifying the slave	UINT8	RO	0x04 (4 _{dec})
1018:01	Vendor ID	Vendor ID of the EtherCAT slave	UINT32	RO	-
1018:02	Product code	Product code of the EtherCAT slave	UINT32	RO	-
1018:03	Revision	Revision number of the EtherCAT slave; the Low Word (bit 0-15) indicates the special device number, the High Word (bit 16-31) refers to the device description	UINT32	RO	-
1018:04	Serial number	Serial number of the EtherCAT slave; the Low Byte (bit 0-7) of the Low Word contains the year of production, the High Byte (bit 8-15) of the Low Word contains the week of production, the High Word (bit 16-31) is 0	UINT32	RO	-

Index 10F0 Backup parameter handling

Index (hex)	Name	Meaning	Data type	Flags	Default
10F0:0	Backup parameter handling	Information for standardized loading and saving of backup entries	UINT8	RO	0x01 (1 _{dec})
10F0:01	Checksum	Checksum across all backup entries of the EtherCAT slave	UINT32	RO	-

Index 180n (AI) TxPDO-Par (for 0 ≤ n ≤ F)

Index (hex)	Name	Meaning	Data type	Flags	Default																																		
180n:0	AI TxPDO-Par standard	PDO parameter TxPDO	UINT8	RO	0x06 (6 _{dec})																																		
180n:06	Exclude TxPDOs	Specifies the TxPDOs (index of TxPDO mapping objects) that must not be transferred together with this PDO	OCTET-STRING[2]	RO	<table border="1"> <thead> <tr> <th>n=</th> <th>Value:</th> </tr> </thead> <tbody> <tr><td>0</td><td>0x011A</td></tr> <tr><td>1</td><td>0x001A</td></tr> <tr><td>2</td><td>0x031A</td></tr> <tr><td>3</td><td>0x021A</td></tr> <tr><td>4</td><td>0x051A</td></tr> <tr><td>5</td><td>0x041A</td></tr> <tr><td>6</td><td>0x071A</td></tr> <tr><td>7</td><td>0x061A</td></tr> <tr><td>8</td><td>0x091A</td></tr> <tr><td>9</td><td>0x081A</td></tr> <tr><td>A</td><td>0x0B1A</td></tr> <tr><td>B</td><td>0x0A1A</td></tr> <tr><td>C</td><td>0x0D1A</td></tr> <tr><td>D</td><td>0x0C1A</td></tr> <tr><td>E</td><td>0x0F1A</td></tr> <tr><td>F</td><td>0x0E1A</td></tr> </tbody> </table>	n=	Value:	0	0x011A	1	0x001A	2	0x031A	3	0x021A	4	0x051A	5	0x041A	6	0x071A	7	0x061A	8	0x091A	9	0x081A	A	0x0B1A	B	0x0A1A	C	0x0D1A	D	0x0C1A	E	0x0F1A	F	0x0E1A
n=	Value:																																						
0	0x011A																																						
1	0x001A																																						
2	0x031A																																						
3	0x021A																																						
4	0x051A																																						
5	0x041A																																						
6	0x071A																																						
7	0x061A																																						
8	0x091A																																						
9	0x081A																																						
A	0x0B1A																																						
B	0x0A1A																																						
C	0x0D1A																																						
D	0x0C1A																																						
E	0x0F1A																																						
F	0x0E1A																																						

Index 1A0n AI TxPDO-Map Standard (for n = 0, 2, 4 ... E; p = 0, 1, 2 ... 7)

Index (hex)	Name	Meaning	Data type	Flags	Default
1A0n:0	AI TxPDO-Map standard	PDO Mapping TxPDO	UINT8	RO	0x0B (11 _{dec})
1A0n:01	SubIndex 001	1. PDO Mapping entry (object 0x60p0 (AI Inputs), entry 0x01 (Underrange))	UINT32	RO	0x60p0:01, 1
1A0n:02	SubIndex 002	2. PDO Mapping entry (object 0x60p0 (AI Inputs), entry 0x02 (Overrange))	UINT32	RO	0x60p0:02, 1
1A0n:03	SubIndex 003	3. PDO Mapping entry (object 0x60p0 (AI Inputs), entry 0x03 (Limit 1))	UINT32	RO	0x60p0:03, 2
1A0n:04	SubIndex 004	4. PDO Mapping entry (object 0x60p0 (AI Inputs), entry 0x05 (Limit 2))	UINT32	RO	0x60p0:05, 2
1A0n:05	SubIndex 005	5. PDO Mapping entry (object 0x60p0 (AI Inputs), entry 0x07 (Error))	UINT32	RO	0x60p0:07, 1
1A0n:06	SubIndex 006	6. PDO Mapping entry (1 bit align)	UINT32	RO	0x0000:00, 1
1A0n:07	SubIndex 007	7. PDO Mapping entry (5 bits align)	UINT32	RO	0x0000:00, 5
1A0n:08	SubIndex 008	8. PDO Mapping entry (object 0x1C32 (SM input parameter), entry 0x20 (Sync error))	UINT32	RO	0x1C32:20, 1
1A0n:09	SubIndex 009	9. PDO Mapping entry (object 0x180n (AI TxPDO-Par standard), entry 0x07 (TxPDO State))	UINT32	RO	0x180n:07, 1
1A0n:0A	SubIndex 010	10. PDO Mapping entry (object 0x180n (AI TxPDO-Par standard), entry 0x09 (TxPDO Toggle))	UINT32	RO	0x180n:09, 1
1A0n:0B	SubIndex 011	11. PDO Mapping entry (object 0x60p0 (AI Inputs), entry 0x11 (Value))	UINT32	RO	0x60p0:11, 16

Index 1A0n AI TxPDO-Map Compact (for n = 1, 3, 5 ... F; p = 0, 1, 2 ... 7)

Index (hex)	Name	Meaning	Data type	Flags	Default
1A0n:0	AI TxPDO-Map Compact	PDO Mapping TxPDO	UINT8	RO	0x01 (1 _{dec})
1A0n:01	SubIndex 001	1. PDO Mapping entry (object 0x60p0 (AI Inputs), entry 0x11 (Value))	UINT32	RO	0x60p00:11, 16

Index 1C00 Sync manager type

Index (hex)	Name	Meaning	Data type	Flags	Default
1C00:0	Sync manager type	Using the sync managers	UINT8	RO	0x04 (4 _{dec})
1C00:01	SubIndex 001	Sync-Manager Type Channel 1: Mailbox Write	UINT8	RO	0x01 (1 _{dec})
1C00:02	SubIndex 002	Sync-Manager Type Channel 2: Mailbox Read	UINT8	RO	0x02 (2 _{dec})
1C00:03	SubIndex 003	Sync-Manager Type Channel 3: Process Data Write (Outputs)	UINT8	RO	0x03 (3 _{dec})
1C00:04	SubIndex 004	Sync-Manager Type Channel 4: Process Data Read (Inputs)	UINT8	RO	0x04 (4 _{dec})

Index 1C12 RxPDO assign

Index (hex)	Name	Meaning	Data type	Flags	Default
1C12:0	RxPDO assign	PDO Assign Outputs	UINT8	RW	0x00 (0 _{dec})

Index 1C13 TxPDO assign

For operation on masters other than TwinCAT it must be ensured that the channels are entered in the PDO assignment ("TxPDO assign", object 0x1C13) successively.

Index (hex)	Name	Meaning	Data type	Flags	Default
1C13:0	TxPDO assign	PDO Assign Inputs	UINT8	RW	0x02 (2 _{dec})
1C13:01	SubIndex 001	1. allocated TxPDO (contains the index of the associated TxPDO mapping object)	UINT16	RW	0x1A00 (6656 _{dec})
1C13:02	SubIndex 002	2. allocated TxPDO (contains the index of the associated TxPDO mapping object)	UINT16	RW	0x1A02 (6658 _{dec})

Index 1C33 SM input parameter

Index (hex)	Name	Meaning	Data type	Flags	Default
1C33:0	SM input parameter	Synchronization parameters for the inputs	UINT8	RO	0x20 (32 _{dec})
1C33:01	Sync mode	Current synchronization mode: <ul style="list-style-type: none"> • Bit 0 = 0: Free Run • Bit 0 = 1: Synchronous with SM 3 event • Bit 0-1 = 11: DC with SYNC1 event • Bit 15 = 1: Fast mode 	UINT16	RW	0x0001 (1 _{dec})
1C33:02	Cycle time	Cycle time (in ns): <ul style="list-style-type: none"> • Free Run: Cycle time of the local timer • Synchronous with SM 2 event: Master cycle time • DC mode: SYNC0/SYNC1 Cycle Time 	UINT32	RW	0x000F4240 (1000000 _{dec})
1C33:03	Shift time	Time between SYNC0 event and reading of the inputs (in ns, only DC mode)	UINT32	RO	0x00004E20 (20000 _{dez})
1C33:04	Sync modes supported	Supported synchronization modes: <ul style="list-style-type: none"> • Bit 0 = 1: Free Run is supported • Bit 1: Synchron with SM 3 Event is supported (no Outputs available) • Bit 2 = 1: DC mode (SYNC0) • Bit 3 = 1: DC mode (SYNC1) • Bit 4-5 = 01: Input Shift with local event (Outputs available) • Bit 4-5 = 10: Input Shift with SYNC1 Event (no Outputs available) • Bit 12 = 1: Legacy Synchron • Bit 13 = 1: SM event • Bit 14 = 1: dynamic times (measure by writing 1C33:08 [p 88]) • Bit 15 = 1: Fast mode 	UINT16	RO	0x440B (17419 _{dez})
1C33:05	Minimum cycle time	Minimum cycle time (in ns)	UINT32	RO	0x000927C0 (6000000 _{dec})
1C33:06	Calc and copy time	Time between reading of the inputs and availability of the inputs for the master (in ns, only DC mode)	UINT32	RO	0x0008D9A0 (580000 _{dez})
1C33:08	Command	With this entry the real required process data provision time can be measured. <ul style="list-style-type: none"> • 0: Measurement of the local cycle time is stopped • 1: Measurement of the local cycle time is started <p>The entries 1C33:03 [p 88], 1C33:06 [p 88], and 1C33:09 [p 88] are updated with the maximum measured values. For a subsequent measurement the measured values are reset</p>	UINT16	RW	0x0000 (0 _{dec})
1C33:09	Maximum Delay time	Time between SYNC1 event and reading of the inputs (in ns, only DC mode)	UINT32	RO	0x00000000 (0 _{dez})
1C33:0B	SM event missed counter	Number of missed SM events in OPERATIONAL (DC mode only)	UINT16	RO	0x0000 (0 _{dec})
1C33:0C	Cycle exceeded counter	Number of occasions the cycle time was exceeded in OPERATIONAL (cycle was not completed in time or the next cycle began too early)	UINT16	RO	0x0000 (0 _{dec})
1C33:0D	Shift too short counter	Number of occasions that the interval between SYNC0 and SYNC1 event was too short (DC mode only)	UINT16	RO	0x0000 (0 _{dec})
1C33:20	Sync error	The synchronization was not correct in the last cycle (outputs were output too late; DC mode only)	BOOLEAN	RO	0x00 (0 _{dec})

Index F000 Modular device profile

Index (hex)	Name	Meaning	Data type	Flags	Default
F000:0	Modular device profile	General information for the modular device profile	UINT8	RO	0x02 (2 _{dec})
F000:01	Module index distance	Index spacing of the objects of the individual channels	UINT16	RO	0x0010 (16 _{dec})
F000:02	Maximum number of modules	Number of channels	UINT16	RO	0x0002 (2 _{dec})

Index F008 Code word

Index	Name	Meaning	Data type	Flags	Default
F008:0	Code word	reserved	UINT32	RW	0x00000000 (0 _{dec})

Index F009 Password protection

Index (hex)	Name	Meaning	Data type	Flags	Default
F009:0	Password protection	Password protection user calibration	UINT32	RW	0x00000000 (0 _{dec})

Index F010 Module list (for 1 ≤ n ≤ 8)

Index (hex)	Name	Meaning	Data type	Flags	Default
F010:0	Module list	Maximum subindex	UINT8	RW	0x02 (2 _{dec})
F010:0n	SubIndex 00n	Analog input profile (300)	UINT32	RW	0x0000012C (300 _{dec})

6 Appendix

6.1 EtherCAT AL Status Codes

For detailed information please refer to the [EtherCAT system description](#).

6.2 UL notice

● Application

i The modules are intended for use with Beckhoff's UL Listed EtherCAT System only.

● Examination

i For cULus examination, the Beckhoff I/O System has only been investigated for risk of fire and electrical shock (in accordance with UL508 and CSA C22.2 No. 142).

● For devices with Ethernet connectors

i Not for connection to telecommunication circuits.

Basic principles

Two UL certificates are met in the Beckhoff EtherCAT product range, depending upon the components:

1. UL certification according to UL508. Devices with this kind of certification are marked by this sign:



2. UL certification according to UL508 with limited power consumption. The current consumed by the device is limited to a max. possible current consumption of 4 A. Devices with this kind of certification are marked by this sign:

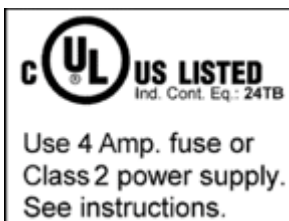

Almost all current EtherCAT products (as at 2010/05) are UL certified without restrictions.

Application

If *restricted* certified devices are used, the current consumption at 24 V_{DC} must be limited accordingly by supplying

- from an isolated source protected by a fuse of max. 4 A (according to UL248) or
- from a voltage supply complying with *NEC class 2*.
An *NEC class 2* voltage source must not be connected in series or parallel with another *NEC class 2* voltage source!

These requirements apply to the supply of all EtherCAT bus couplers, power supply terminals, bus terminals and their power contacts.

6.3 Support and Service

Beckhoff and their partners around the world offer comprehensive support and service, making available fast and competent assistance with all questions related to Beckhoff products and system solutions.

Beckhoff's branch offices and representatives

Please contact your Beckhoff branch office or representative for local support and service on Beckhoff products!

The addresses of Beckhoff's branch offices and representatives round the world can be found on her internet pages: www.beckhoff.com

You will also find further documentation for Beckhoff components there.

Support

The Beckhoff Support offers you comprehensive technical assistance, helping you not only with the application of individual Beckhoff products, but also with other, wide-ranging services:

- support
- design, programming and commissioning of complex automation systems
- and extensive training program for Beckhoff system components

Hotline: +49 5246 963 157
e-mail: support@beckhoff.com
web: www.beckhoff.com/support

Service

The Beckhoff Service Center supports you in all matters of after-sales service:

- on-site service
- repair service
- spare parts service
- hotline service

Hotline: +49 5246 963 460
e-mail: service@beckhoff.com
web: www.beckhoff.com/service

Headquarters Germany

Beckhoff Automation GmbH & Co. KG

Hülshorstweg 20
33415 Verl
Germany

Phone: +49 5246 963 0
e-mail: info@beckhoff.com
web: www.beckhoff.com

List of figures

Fig. 1	Side name plate of EPX1058-0022, EPX3158-0022 and EPX3184-0022	9
Fig. 2	EPX3158-0022 - 8-channel analog EtherCAT Box, 4...20 mA, single-ended, 16 bit, Ex i	10
Fig. 3	EPX EtherCAT Box - Dimensions	16
Fig. 4	EPX EtherCAT Box - Functional earth via the fastening holes	17
Fig. 5	Connectors using EPX1058-0022 as an example	18
Fig. 6	EtherCAT connector.....	19
Fig. 7	EtherCAT connector - pin assignment	19
Fig. 8	EtherCAT - status LEDs.....	20
Fig. 9	Power supply connector - input (left), downstream connection (right)	21
Fig. 10	Connector of the power supply - pin assignment	21
Fig. 11	Status LEDs for the supply voltages	22
Fig. 12	Voltage drop on the supply line.....	22
Fig. 13	M12 connector of the inputs - pin assignment	23
Fig. 14	EPX3158 - signal LEDs.....	23
Fig. 15	Full scale value, measuring span.....	24
Fig. 16	SE and DIFF module as 2-channel version	27
Fig. 17	2-wire connection	29
Fig. 18	Common-mode voltage (V_{cm})	30
Fig. 19	Recommended operating voltage range	31
Fig. 20	Signal processing analog input	32
Fig. 21	Diagram Signal delay (step response).....	33
Fig. 22	Diagram Signal delay (linear).....	33
Fig. 23	Representation of the definitions from NAMUR recommendation NE43, version 03/02/2003.....	34
Fig. 24	System Manager "Options" (TwinCAT 2).....	36
Fig. 25	Call up under VS Shell (TwinCAT 3).....	36
Fig. 26	Overview of network interfaces	36
Fig. 27	EtherCAT device properties(TwinCAT 2): click on "Compatible Devices..." of tab "Adapte".....	37
Fig. 28	Windows properties of the network interface	37
Fig. 29	Exemplary correct driver setting for the Ethernet port.....	38
Fig. 30	Incorrect driver settings for the Ethernet port	39
Fig. 31	TCP/IP setting for the Ethernet port	40
Fig. 32	Identifier structure	41
Fig. 33	OnlineDescription information window (TwinCAT 2).....	42
Fig. 34	Information window OnlineDescription (TwinCAT 3).....	42
Fig. 35	File OnlineDescription.xml created by the System Manager	43
Fig. 36	Indication of an online recorded ESI of EL2521 as an example	43
Fig. 37	Information window for faulty ESI file (left: TwinCAT 2; right: TwinCAT 3)	43
Fig. 38	Using the ESI Updater (\geq TwinCAT 2.11).....	45
Fig. 39	Using the ESI Updater (TwinCAT 3)	45
Fig. 40	Append EtherCAT device (left: TwinCAT 2; right: TwinCAT 3).....	46
Fig. 41	Selecting the EtherCAT connection (TwinCAT 2.11, TwinCAT 3)	46
Fig. 42	Selecting the Ethernet port	46
Fig. 43	EtherCAT device properties (TwinCAT 2).....	47
Fig. 44	Appending EtherCAT devices (left: TwinCAT 2; right: TwinCAT 3)	47

Fig. 45	Selection dialog for new EtherCAT device	48
Fig. 46	Display of device revision	48
Fig. 47	Display of previous revisions	49
Fig. 48	Name/revision of the terminal	49
Fig. 49	EtherCAT terminal in the TwinCAT tree (left: TwinCAT 2; right: TwinCAT 3).....	50
Fig. 50	Differentiation local/target system (left: TwinCAT 2; right: TwinCAT 3).....	51
Fig. 51	Scan Devices (left: TwinCAT 2; right: TwinCAT 3)	51
Fig. 52	Note for automatic device scan (left: TwinCAT 2; right: TwinCAT 3).....	51
Fig. 53	Detected Ethernet devices	52
Fig. 54	Example default state.....	52
Fig. 55	Installing EthetCAT terminal with revision -1018.....	53
Fig. 56	Detection of EtherCAT terminal with revision -1019	53
Fig. 57	Scan query after automatic creation of an EtherCAT device (left: TwinCAT 2; right: TwinCAT 3).....	53
Fig. 58	Manual triggering of a device scan on a specified EtherCAT device (left: TwinCAT 2; right: TwinCAT 3)	54
Fig. 59	Scan progressexemplary by TwinCAT 2.....	54
Fig. 60	Config/FreeRun query (left: TwinCAT 2; right: TwinCAT 3).....	54
Fig. 61	Displaying of “Free Run” and “Config Mode” toggling right below in the status bar.....	54
Fig. 62	TwinCAT can also be switched to this state by using a button (left: TwinCAT 2; right: TwinCAT 3).....	54
Fig. 63	Online display example	55
Fig. 64	Faulty identification	55
Fig. 65	Identical configuration (left: TwinCAT 2; right: TwinCAT 3)	56
Fig. 66	Correction dialog	56
Fig. 67	Name/revision of the terminal	57
Fig. 68	Correction dialog with modifications	58
Fig. 69	Dialog “Change to Compatible Type...” (left: TwinCAT 2; right: TwinCAT 3)	58
Fig. 70	TwinCAT 2 Dialog Change to Alternative Type.....	58
Fig. 71	Branch element as terminal EL3751	59
Fig. 72	“General” tab	59
Fig. 73	“EtherCAT” tab	60
Fig. 74	“Process Data” tab	61
Fig. 75	Configuring the process data	62
Fig. 76	“Startup” tab	63
Fig. 77	“CoE - Online” tab	64
Fig. 78	Dialog “Advanced settings”	65
Fig. 79	“Online” tab	65
Fig. 80	“DC” tab (Distributed Clocks)	66
Fig. 81	Parameterization taking the ELX3152 as an example	68
Fig. 82	Input byte definition	70
Fig. 83	Linking of 2-bit variable to additional task	70
Fig. 84	Relationship of operation modes.....	71
Fig. 85	Attenuation curve notch.filter at 50 Hz	73
Fig. 86	ELX3152 default process data	74
Fig. 87	Show Sub Items	75
Fig. 88	Display of the subvariables using the ELX3152 as an example	75

Fig. 89	Selective PDO selection taking the ELX3152 as an example.....	76
Fig. 90	Element-orientated process image under TwinCAT 2.10	77
Fig. 91	Password protection for the 0x8000:17 and 0x8000:18 entries (example).....	77
Fig. 92	Data stream of the ELX31xx/EPX3158	79
Fig. 93	ELX3152 - Measuring range 0...20 mA.....	81
Fig. 94	ELX315x/EPX3158 - Measuring range 4...20 mA.....	81
Fig. 95	ELX315x/EPX3158 - Measuring range 4...20 mA (NAMUR NE43).....	82

More Information:
www.beckhoff.com/EPX3158-0022

Beckhoff Automation GmbH & Co. KG
Hülshorstweg 20
33415 Verl
Germany
Phone: +49 5246 9630
info@beckhoff.com
www.beckhoff.com

