

Documentation | EN

EPP3356-0022

1-channel analog input, measuring bridge, full bridge, 24 bit, M12



Table of contents

1	Foreword	5
1.1	Notes on the documentation	5
1.2	Safety instructions	6
1.3	Documentation issue status	7
2	Product group: EtherCAT P Box modules	8
3	Product overview	9
3.1	Introduction	9
3.2	Technical data	10
3.3	Scope of supply.....	11
4	Basics	12
4.1	Basics of strain gauge technology	12
4.2	Basic function principles.....	13
5	Mounting and Cabling	21
5.1	Mounting	21
5.1.1	Dimensions	21
5.1.2	Fixing.....	22
5.1.3	Tightening torques for plug connectors.....	22
5.1.4	Functional earth (FE)	22
5.2	EtherCAT P	23
5.2.1	Connectors.....	24
5.2.2	Status LEDs	25
5.2.3	Conductor losses	26
5.3	Resistor bridge	27
5.3.1	Parallel connection of strain gauges	29
5.4	Disposal	30
6	Commissioning/Configuration	31
6.1	Integrating into a TwinCAT project.....	31
6.2	Selection of the process data	32
6.3	Application notes	33
6.4	Calibration and adjustment	36
6.5	Voltage measurement	41
6.6	Distributed Clocks mode	43
6.7	Process data	44
6.8	Sample program.....	51
6.9	Restore the delivery state	52
7	Decommissioning	53
8	CoE parameters	54
9	Appendix	67
9.1	General operating conditions	67
9.2	Accessories	68
9.3	Continuative documentation for I/O components with analog in and outputs	69
9.4	Version identification of EtherCAT devices	70

9.4.1	General notes on marking.....	70
9.4.2	Version identification of IP67 modules.....	71
9.4.3	Beckhoff Identification Code (BIC).....	72
9.4.4	Electronic access to the BIC (eBIC).....	74
9.5	Support and Service.....	76

1 Foreword

1.1 Notes on the documentation

Intended audience

This description is only intended for the use of trained specialists in control and automation engineering who are familiar with the applicable national standards.

It is essential that the documentation and the following notes and explanations are followed when installing and commissioning these components.

The qualified personnel is obliged to always use the currently valid documentation.

The responsible staff must ensure that the application or use of the products described satisfy all the requirements for safety, including all the relevant laws, regulations, guidelines and standards.

Disclaimer

The documentation has been prepared with care. The products described are, however, constantly under development.

We reserve the right to revise and change the documentation at any time and without prior announcement.

No claims for the modification of products that have already been supplied may be made on the basis of the data, diagrams and descriptions in this documentation.

Trademarks

Beckhoff®, TwinCAT®, TwinCAT/BSD®, TC/BSD®, EtherCAT®, EtherCAT G®, EtherCAT G10®, EtherCAT P®, Safety over EtherCAT®, TwinSAFE®, XFC®, XTS® and XPlanar® are registered trademarks of and licensed by Beckhoff Automation GmbH. Other designations used in this publication may be trademarks whose use by third parties for their own purposes could violate the rights of the owners.

Patent Pending

The EtherCAT Technology is covered, including but not limited to the following patent applications and patents: EP1590927, EP1789857, EP1456722, EP2137893, DE102015105702 with corresponding applications or registrations in various other countries.



EtherCAT® is registered trademark and patented technology, licensed by Beckhoff Automation GmbH, Germany.

Copyright

© Beckhoff Automation GmbH & Co. KG, Germany.

The reproduction, distribution and utilization of this document as well as the communication of its contents to others without express authorization are prohibited.

Offenders will be held liable for the payment of damages. All rights reserved in the event of the grant of a patent, utility model or design.

1.2 Safety instructions

Safety regulations

Please note the following safety instructions and explanations!
Product-specific safety instructions can be found on following pages or in the areas mounting, wiring, commissioning etc.

Exclusion of liability

All the components are supplied in particular hardware and software configurations appropriate for the application. Modifications to hardware or software configurations other than those described in the documentation are not permitted, and nullify the liability of Beckhoff Automation GmbH & Co. KG.

Personnel qualification

This description is only intended for trained specialists in control, automation and drive engineering who are familiar with the applicable national standards.

Signal words

The signal words used in the documentation are classified below. In order to prevent injury and damage to persons and property, read and follow the safety and warning notices.

Personal injury warnings

⚠ DANGER

Hazard with high risk of death or serious injury.

⚠ WARNING

Hazard with medium risk of death or serious injury.

⚠ CAUTION

There is a low-risk hazard that could result in medium or minor injury.

Warning of damage to property or environment

NOTICE

The environment, equipment, or data may be damaged.

Information on handling the product



This information includes, for example:
recommendations for action, assistance or further information on the product.

1.3 Documentation issue status

Version	Comment
1.0	<ul style="list-style-type: none">• First release

Firm and hardware version

The documentation refers to the firm and hardware status that was valid at the time it was prepared.

The properties of the modules are subject to continuous development and improvement. Modules having earlier production statuses cannot have the same properties as modules with the latest status. Existing properties, however, are always retained and are not changed, so that these modules can always be replaced by new ones.

The firmware and hardware version (delivery state) can be found in the batch number (D number) printed at the side of the EtherCAT Box.

Syntax of the batch number (D number)

D: WW YY FF HH	Example with D No. 29 10 02 01:
WW - week of production (calendar week)	29 - week of production 29
YY - year of production	10 - year of production 2010
FF - firmware version	02 - firmware version 02
HH - hardware version	01 - hardware version 01

Further information on this topic: [Version identification of EtherCAT devices](#) [► 70].

2 Product group: EtherCAT P Box modules

EtherCAT P

EtherCAT P supplements the EtherCAT technology with a process in which communication and supply voltages are transmitted on a common line. All EtherCAT properties are retained with this process.

Two supply voltages are transmitted per EtherCAT P line. The supply voltages are electrically isolated from each other and can therefore be switched individually. The nominal supply voltage for both is $24 V_{DC}$.

EtherCAT P uses the same cable structure as EtherCAT: a 4-core Ethernet cable with M8 connectors. The connectors are mechanically coded so that EtherCAT connectors and EtherCAT P connectors cannot be interchanged.

EtherCAT P Box modules

EtherCAT P Box modules are EtherCAT P slaves with degree of protection IP67. They are designed for operation in wet, dirty or dusty industrial environments.

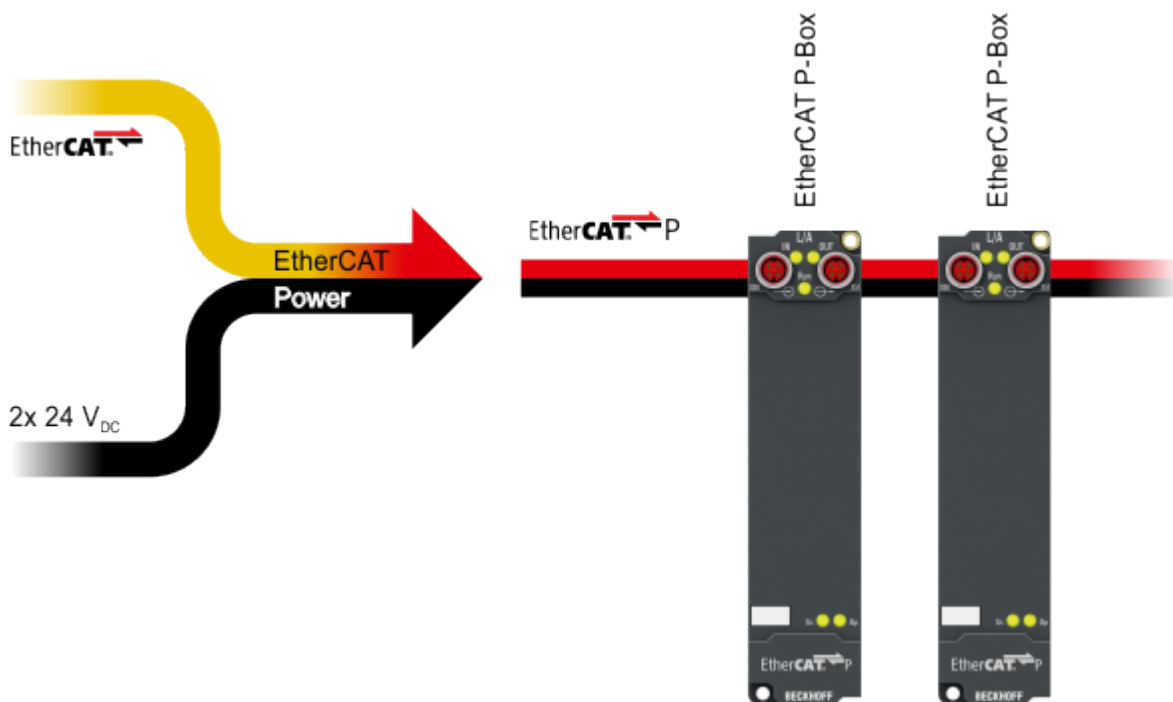

i EtherCAT basics

A detailed description of the EtherCAT system can be found in the [EtherCAT system documentation](#).

3 Product overview

3.1 Introduction

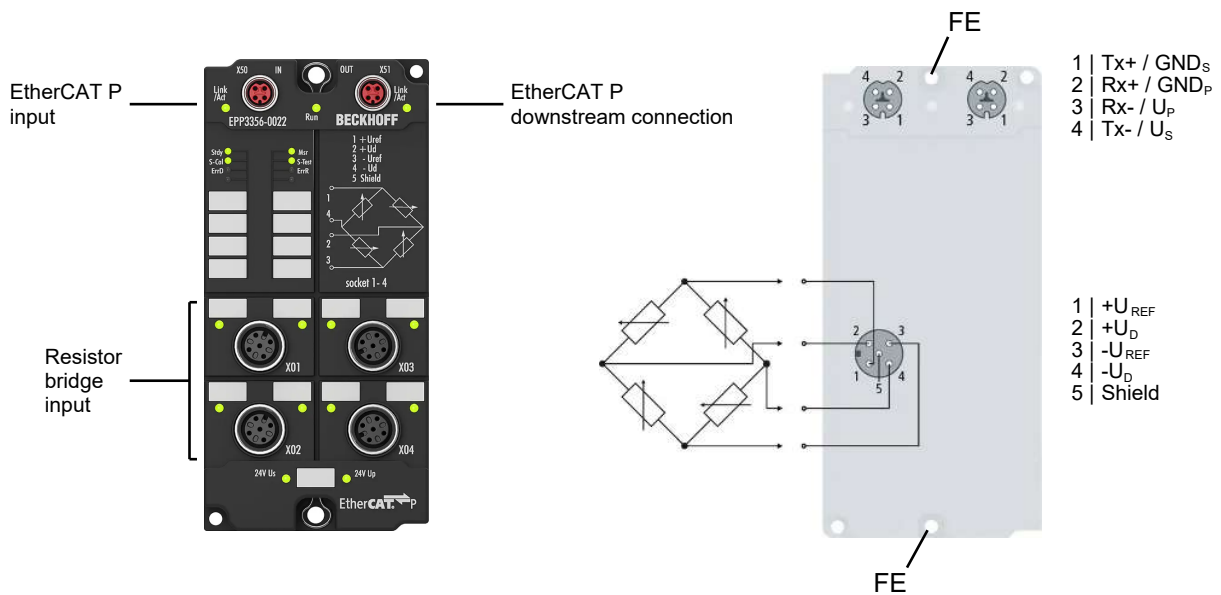

The EPP3356-0022 EtherCAT P-Box enables the direct connection of a resistor bridge (strain gauge – SG) or a load cell using a 4-wire connection technique. The ratio of the bridge voltage U_D to the supply voltage U_{REF} is determined with high precision in the input circuit and the final load value is calculated as a process value on the basis of the settings in the EPP3356-0022. With automatic self-calibration (which can be deactivated), dynamic filters, support for Distributed Clocks and a sampling rate of up to 100 μ s, the EPP3356-0022 is particularly suitable for the fast and precise acquisition of signals from torque or vibration sensors.

All four M12 sockets are occupied, so that the parallel use of several strain gauges is possible.

Quick links

[Mounting \[► 21\]](#)

[Resistor bridge \[► 27\]](#)

[Basic function principles \[► 13\]](#)

[Calibration and adjustment \[► 36\]](#)

3.2 Technical data

All values are typical values over the entire temperature range, unless stated otherwise.

EtherCAT P	
Connection	2 x M8 socket, 4-pin, P-coded, shielded
Distributed Clocks	yes
Minimum cycle time	100 μ s

Supply voltages	
Connection	See EtherCAT P connection
U_s nominal voltage	24 V _{DC} (-15 % / +20 %)
U_s sum current: $I_{s,sum}$	max. 3 A
Current consumption from U_s	100 mA
Rated voltage U_p	24 V _{DC} (-15 % / +20 %)
U_p sum current: $I_{p,sum}$	max. 3 A
Current consumption from U_p	The measuring bridge supply voltage U_{ref} is generated internally from U_p .

Measuring bridge connection	
Signal interface [► 27]	M12 socket, 5-pin, A-coded
Signal type	Resistor bridge, strain gauge (SG)
Number of analog inputs	2, for 1 bridge circuit in full bridge technology.
Cable length	max. 30 m between box and measuring bridge
Measured value resolution	24-bit, 32-bit representation
Conversion time	0.1 ... 250 ms, configurable
Conversion rate	4 ... 10,000 samples/s (reciprocal of the conversion time)
Measuring error	< ± 0.01 % ¹⁾ for the calculated load value based on the load end value with 10 V power supply and 20 mV bridge voltage (therefore nominal characteristic value for SG: 2 mV/V), self-calibration active, 50 Hz filter active.
Measuring range U_D	max. -27 ... +27 mV ²⁾ Recommended: -25 ... +25 mV nominal voltage
Measuring range U_{ref}	max. -13.8 ... +13.8 V ²⁾
Supported nominal characteristic values	any, resolution of the parameter: 0.01 μ V/V Recommended: 0.5 ... 2.5 mV/V
min. strain gauge resistance	Parallel use of strain gauges only recommended with suitable strain gauges
Input filter (hardware) cut-off frequency	10 kHz low-pass (-3 dB, see filter notes)
Filter (software)	Preset 50 Hz, configurable: 50/60 Hz FIR notch filter, IIR low-pass, 4-fold averager
Internal resistance	<ul style="list-style-type: none"> U_{ref}-measurement input: > 200 kΩ U_D-measurement input: > 1 MΩ
Measuring bridge supply voltage (sensor power supply)	U_{ref} = 10 V (generated internally from U_p) max. 350 mA

¹⁾ External influences such as Temperature drift and RF interference can increase the measuring error.

²⁾ See chapter [Voltage measurement \[► 41\]](#).

Housing data	
Dimensions W x H x D	60 mm x 126 mm x 26.5 mm (without plug connectors)
Weight	approx. 250 g
Installation position	variable
Material	PA6 (polyamide)

Approvals / markings	
Approvals / markings *)	CE, UL under preparation

*) Real applicable approvals/markings see type plate on the side (product marking).

Additional tests

The devices have undergone the following additional tests:

Test	Explanation
Vibration	10 frequency sweeps in 3 axes
	5 Hz < f < 60 Hz displacement 0.35 mm, constant amplitude
	60.1 Hz < f < 500 Hz acceleration 5 g, constant amplitude
Shocks	1000 shocks in each direction, in 3 axes
	35 g, 11 ms

3.3 Scope of supply

Make sure that the following components are included in the scope of delivery:

- 1x EPP3356-0022
- 2x protective cap for EtherCAT P socket, M8, red (pre-assembled)
- 10x labels, blank (1 strip of 10)



Pre-assembled protective caps do not ensure IP67 protection

Protective caps are pre-assembled at the factory to protect connectors during transport. They may not be tight enough to ensure IP67 protection.

Ensure that the protective caps are correctly seated to ensure IP67 protection.

4 Basics

4.1 Basics of strain gauge technology

The basics of the strain gauge technology can be found in the I/O Analog Manual: [Link](#)

i Generalized information in the I/O Analog Manual

The I/O Analog Manual contains information for all analog I/O products from Beckhoff. Therefore, not all information applies to EPP3356-0022.

There are deviations in the following points in particular:

- The EPP3356-0022 only supports the 4-wire connection. A 6-wire connection is not possible.
 - The reference voltage is generated in the EPP3356-0022 from U_p and is 10 V. Do not apply an external reference voltage.
-

4.2 Basic function principles

The measuring functions of the EPP3356-0022 can be described as follows:

- The EPP3356-0022 Analog Input Box are used to acquire the supply voltage to a load cell as a reference voltage, and the differential voltage that is proportional to the force acting on the cell.
- It is compulsory to connect a full bridge. If there is only a quarter or half bridge available, you have to add external auxiliary bridges. In this case you have to modify the nominal characteristic value.
- The reference and differential voltages are measured simultaneously
- Since the two voltages are measured at the same time, there is basically no need for a high-precision reference voltage with respect to the level. On changing the reference voltage, the differential voltage across the full bridge changes by the same degree. Therefore a stabilized reference voltage should be used that is subject to only low fluctuations (e.g. the EL95xx supply terminal)
- The change of the quotient of the differential and reference voltages corresponds to the relative force acting on the load cell.
- The quotient is converted into a weight and is output as process data.
- The data processing is subject to the following filtering procedures:
 - the analog converter (ADC) integrates over 76 samples
 - calculation of mean values in the averager (if activated)
 - software filter IIR/FIR (if activated)
- The EPP3356-0022 has an automatic compensation/self-calibration function. Default state: self-calibration activated, execution every 3 minutes
 - errors in the analog input stages (temperature drift, long-term drift etc.) are checked by regular automatic calibration, and compensated to bring the measurement within the permitted tolerance range.
 - the automatic function can be deactivated or activated in a controlled manner
- The EPP3356-0022 can also be used as a 2-channel analog input box for voltage measurement [► 41].
- The EPP3356-0022 has a timestamp function that can be activated through Distributed Clocks. The filter functionality is not available in Distributed Clocks mode.

General notes

- The measuring range should always be used as widely as possible in order to achieve a high measuring accuracy.
- Parallel operation of load cells is possible with the EPP3356-0022. Please note:

- Load cells approved and calibrated by the load cell manufacturer for parallel operation should be used. The nominal characteristic values [mV/V], zero offset [mV/V] and impedance [Ω , ohm] are then usually adjusted accordingly.

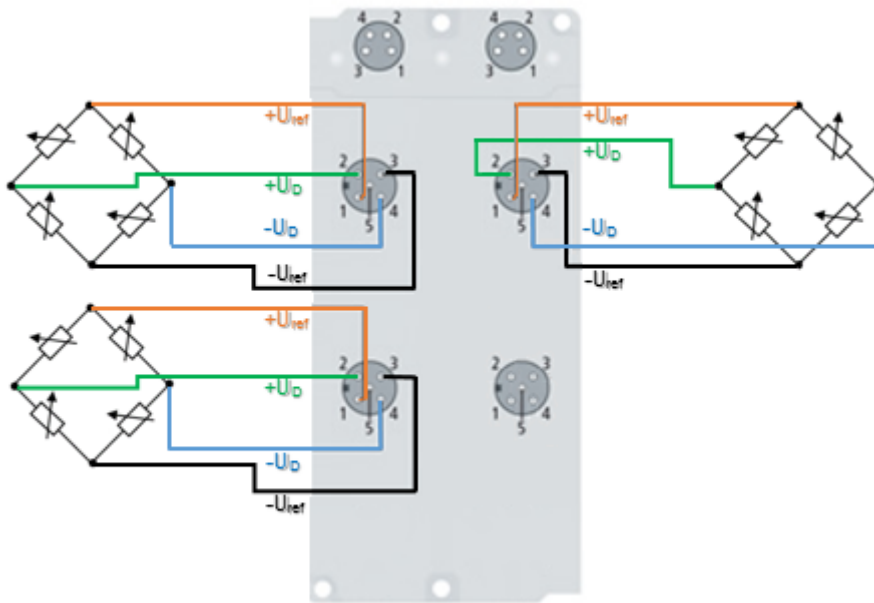

- Load cell signals have a low amplitude and are occasionally very sensitive to electromagnetic interference. Considering the typical system characteristics and taking into account the technical possibilities, purposeful state-of-the-art EMC protective measures are to be taken. In the case of high electromagnetic interference levels, it may be helpful to additionally connect the cable screen before the box using suitable screening material.
- If the EPP3356-0022 is to be used in Distributed Clocks mode:
 - DC must be activated
 - the [Process data](#) [▶ 44] Timestamp must be activated. The filter functionality is not available then.

Signal flow diagram

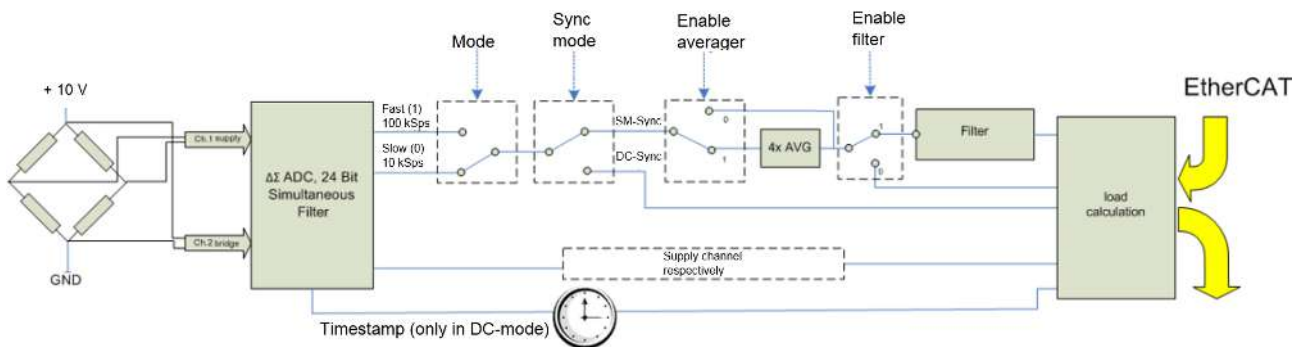

The EPP3356-0022 processes the data in the following order:

- Hardware low-pass 10 kHz
- 2-channel simultaneous sampling at 10.5/105.5 kSps with 64-fold oversampling by delta-sigma ($\Delta\Sigma$) converter and internal pre-filtration
- 4-fold averager (can be deactivated)
- Software filter (can be deactivated)
- Calculating the weight

Measurement principle of delta-sigma ($\Delta\Sigma$) converter

The measurement principle employed in the EPP3356-0022, with real sampling in MHz range, shifts aliasing effects into a very high frequency range, so that normally no such effects are to be expected in the kHz range.

Averager

In order to make use of the high data rates of the Analog-to-Digital converter (ADC) even with slow cycle times, a mean value filter is connected after the ADC. This determines the sliding mean value of the last 4 measured values. This function can be deactivated for each mode via the CoE object "Mode X enable averager".

Software filter

The EPP3356-0022 is equipped with a digital software filter which, depending on its settings, can adopt the characteristics of a Finite Impulse Response filter (FIR filter), or an Infinite Impulse Response filter (IIR filter). The filter is activated by default as 50 Hz-FIR.

In the respective measuring mode the filter can be activated (0x8000:01, 0x8000:02) [► 58] and parameterized (0x8000:11, 0x8000:12) [► 58].

FIR 50/60 Hz

- The filter performs a notch filter function and determines the conversion time of the box. The higher the filter frequency, the faster the conversion time. A 50 Hz and a 60 Hz filter are available. Notch filter means that the filter has zeros (notches) in the frequency response at the filter frequency and multiples thereof, i.e. it attenuates the amplitude at these frequencies. The FIR filter operates as a non-recursive filter.

PDO filter

- The filter behaves like the 50/60 Hz FIR filter described above. However, the filter frequency can be adjusted here in 0.1 Hz steps by means of an output data object. The filter frequency range extends from 0.1 Hz to 200 Hz and can be reparameterised during operation. To do this the PDO 0x1601 ("RMB filter frequency") must be displayed in the process data and the entry "PDO filter frequency" must be selected in the object 0x8000:11. This function allows the EPP3356-0022 to suppress interference of a known frequency in the measuring signal. A typical application, for example, is a silo that is filled and weighed by a driven screw conveyor. The rotary speed of the screw conveyor is known and can be adopted into the object as a frequency. Thus mechanical oscillations can be removed from the measuring signal.

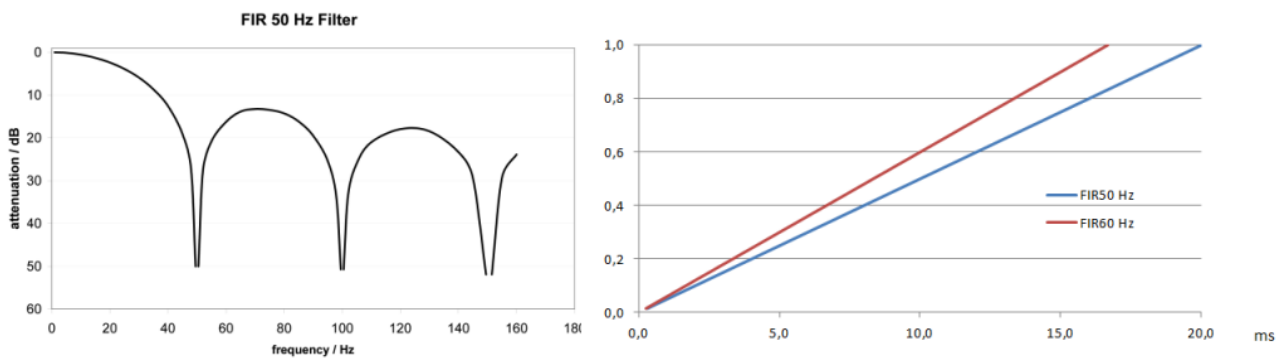

Fig. 1: Notch characteristic/amplitude curve and step response of the FIR filter

IIR-Filter 1 to 8

- The filter with IIR characteristics is a discrete time, linear, time invariant filter that can be set to eight levels (level 1 = weak recursive filter, up to level 8 = strong recursive filter). The IIR can be understood to be a moving average value calculation after a low-pass filter.

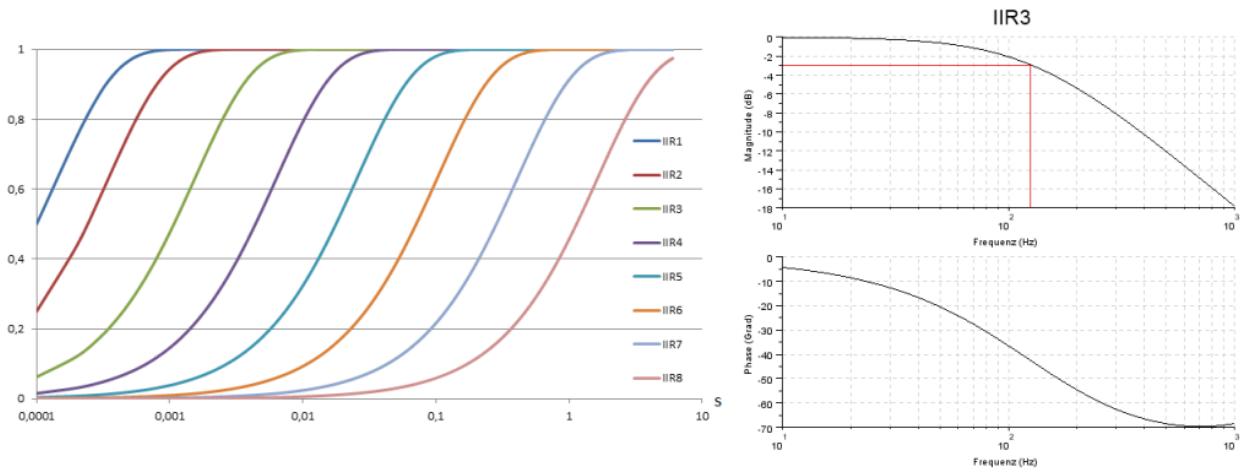

Fig. 2: Step response and Bode diagram of the IIR filter

Overview of conversion times

Filter Settings	Value	PDO update time	Filter property	Limit frequency (-3 dB) [Hz] (typ.)	Comment	Rise time 10-90 % [s] (typ.)
Filter deactivated	-	Cycle-synchronous,, min. 100 µs	-	-	-	-
0	FIR 50 Hz	312.5 µs	50 Hz notch filter	22 Hz	Typ. conversion time 312.5 µs	0.013
1	FIR 60 Hz	260.4 µs	60 Hz notch filter	25 Hz	Typ. conversion time 260.4 µs	0.016
2	IIR1	Cycle-synchronous (up to min. 100 µs)	Low-pass	2000 Hz	$a_0=1/2^1 = 0.5$	0.0003
3	IIR2		Low-pass	500 Hz	$a_0=1/2^2 = 0.25$	0.0008
4	IIR3		Low-pass	125 Hz	$a_0=1/2^4 = 62.5e-3$	0.0035
5	IIR4		Low-pass	30 Hz	$a_0=1/2^6 = 15.6e-3$	0.014
6	IIR5		Low-pass	8 Hz	$a_0=1/2^8 = 3.91e-3$	0.056
7	IIR6		Low-pass	2 Hz	$a_0=1/2^{10} = 977e-6$	0.225
8	IIR7		Low-pass	0.5 Hz	$a_0=1/2^{12} = 244e-6$	0.9
9	IIR8		Low-pass	0.1 Hz	$a_0=1/2^{14} = 61.0e-6$	3.6
10	Dynamic IIR		The filter changes dynamically between the filters IIR1 to IIR8			
11	PDO Filter frequency	1/PDO Value[Hz]*64	Notch filter with adjustable frequency	ca. 0.443 * PDO Value [Hz]	-	-

i Filter and cycle time

If the FIR filters (50 Hz or 60 Hz) are switched on, the process data are updated maximally with the specified conversion time (see table). The IIR filter works cycle-synchronously. Hence, a new measured value is available in each PLC cycle.

At which point the filters can be adjusted is described in the chapter “Object description and parameterization” for example under index 0x8000:12.

i IIR filter

Differential equation: $Y_n = X_n * a_0 + Y_{n-1} * b_1$ with $a_0 + b_1 = 1$
 $a_0 =$ (see table), $b_1 = 1 - a_0$

Dynamic IIR Filter

The dynamic IIR filter automatically switches through the 8 different IIR filters depending on the weight change. The idea:

- The target state is always the IIR8-Filter, i.e. the greatest possible damping and hence a very calm measured value.
- In the input variable changes rapidly the filter is opened, i.e. switched to the next lower filter (if still possible). This gives the signal edge more weight and the measured value curve can follow the load quickly.
- If the measured value changes very little the filter is closed, i.e. switched to the next higher filter (if still possible). Hence the static state is mapped with a high accuracy.
- The evaluation as to whether a downward change of filter is required or whether an upward change is possible takes place continuously at fixed time intervals.

Parameterization takes place via the CoE entries 0x8000:13 and 0x8000:14 [[▶ 58](#)]. Evaluation takes place according to 2 parameters:

- The "Dynamic filter change time" object (0x8000:13) [[▶ 58](#)] is used to set the time interval at which the existing signal is re-evaluated.
- Object 0x8000:14 [[▶ 58](#)] is used to specify the maximum deviation that is permissible during this time without filter switching occurring.

Example:

The dynamic filter is to be adjusted in such a manner that a maximum slope of 0.5 digits per 100 ms (5 digits per second) is possible without the filter being opened. This results in a "calm" measured value. In the case of a faster change, however, it should be possible to immediately follow the load.

- Dynamic filter change time (0x8000:13) [[▶ 58](#)] = 10 (equivalent to 100 ms)
- Object 0x8000:14 [[▶ 58](#)] is used to specify the maximum deviation that is permissible during this time without filter switching occurring.

The measured value curve is shown below for a slower (left) and faster (right) change.

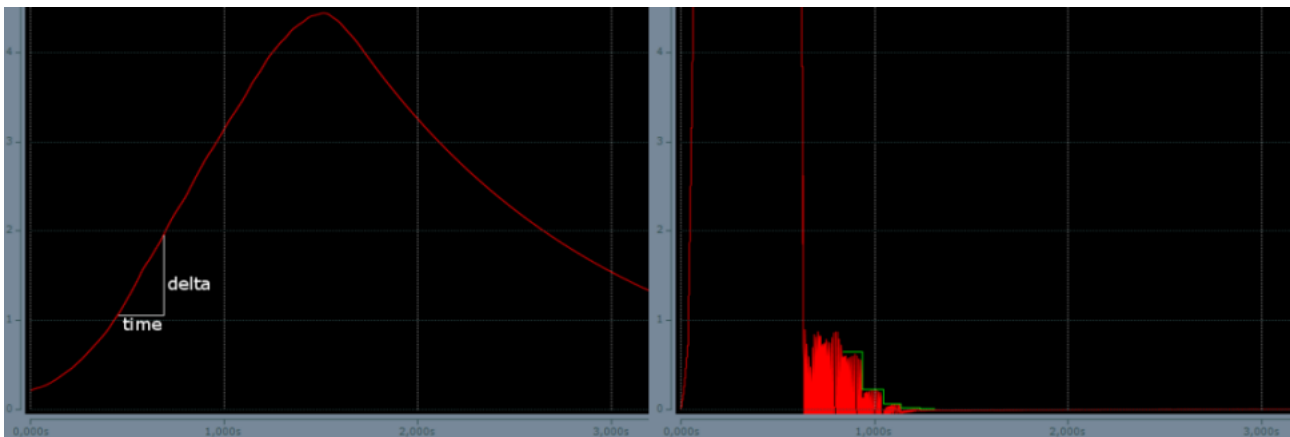

Fig. 3: Effect of dynamic IIR filters

- Left: The scales are slowly loaded. The change in the weight (delta/time) remains below the mark of 0.5 digits per 100 ms. The filter therefore remains unchanged at the strongest level (IIR8), resulting in a low-fluctuation measured value.
- Right: The scales are suddenly loaded. The change in the weight immediately exceeds the limit value of 0.5 digits per 100 ms. The filter is opened every 100 ms by one level (IIR8 --> IIR7 --> IIR6 etc.) and the display value immediately follows the jump. After the removal of the weight the signal quickly falls again. If the change in the weight is less than 0.5 digit per 100 ms, the filter is set one level stronger every 100 ms until IIR8 is reached. The green line is intended to clarify the decreasing "noise level"

Calculating the weight

Each measurement of the analog inputs is followed by the calculation of the resulting weight or the resulting force, which is made up of the ratio of the measuring signal to the reference signal and of several calibrations.

$$Y_R = (U_{\text{Diff}} / U_{\text{ref}}) \times A_i \quad (1.0) \text{ Calculation of the raw value in mV/V}$$

$$Y_L = (Y_R - C_{\text{ZB}}) / (C_n - C_{\text{ZB}}) \times E_{\text{max}} \quad (1.1) \text{ Calculation of the weight}$$

$$Y_S = Y_L \times A_S \quad (1.2) \text{ Scaling factor (e.g. factor 1000 for rescaling from kg to g)}$$

$$Y_G = Y_S \times (G / 9.80665) \quad (1.3) \text{ Influence of acceleration of gravity}$$

$$Y_{\text{AUS}} = Y_G \times \text{Gain} - \text{Tara} \quad (1.4) \text{ Gain and Tare}$$

Legend

Name	Designation	CoE Index
U_{Diff}	Bridge voltage/differential voltage of the sensor element, after averager and filter	
U_{ref}	Bridge supply voltage/reference signal of the sensor element, after averager and filter	
A_i	Internal gain, not changeable. This factor accounts for the unit standardisation from mV to V and the different full-scale deflections of the input channels	
C_n	Nominal characteristic value of the sensor element (unit mV/V, e.g. nominally 2 mV/V or 2.0234 mV/V according to calibration protocol)	8000:23 [▶ 58]
C_{ZB}	Zero balance of the sensor element (unit mV/V, e.g. -0.0142 according to calibration protocol)	8000:25 [▶ 58]
E_{max}	Nominal load of the sensor element	8000:24 [▶ 58]
A_S	Scaling factor (e.g. factor 1000 for rescaling from kg to g)	8000:27 [▶ 58]
G	Acceleration of gravity in m/s ² (default: 9.80665 ms/s ²)	8000:26 [▶ 58]
Gain		8000:21 [▶ 58]
Tare		8000:22 [▶ 58]

Conversion mode

The so-called conversion mode determines the speed and latency of the analog measurement in the EPP3356-0022. The characteristics:

Mode	Meaning	typ. latency	typ. current consumption
0	<i>High precision</i> Analog conversion at 10.5 kSps (samples per second) Slow conversion and thus high accuracy	7,2 ms	70 % (see Technical data [▶ 10] regarding nominal value)
1	<i>High speed / low latency</i> Analog conversion at 105.5 kSps (samples per second) Fast conversion with low latency	0,72 ms	100 % (see Technical data [▶ 10] regarding nominal value)

Due to the conversion principle of the EPP3356-0022, the analog voltage is only available as a digital value after a defined time. This is shown in figure below.

A step signal 0->1 is applied to the input. The measured value is reached and readable within the defined accuracy after 7.2 ms or 0.72 ms, depending on the conversion mode 0/1. At this time the timestamp is also acquired in Distributed Clocks mode. In real operation a step signal is not normally connected, but rather a

higher frequency but constant signal. The EPP3356-0022 then maps the input signal with the corresponding latency for further processing, for which reason faster querying of the sampling unit at shorter intervals than the latency (EPP3356-0022 allows up to 100 µs) makes sense for true-to-detail mapping of the analog input signal.

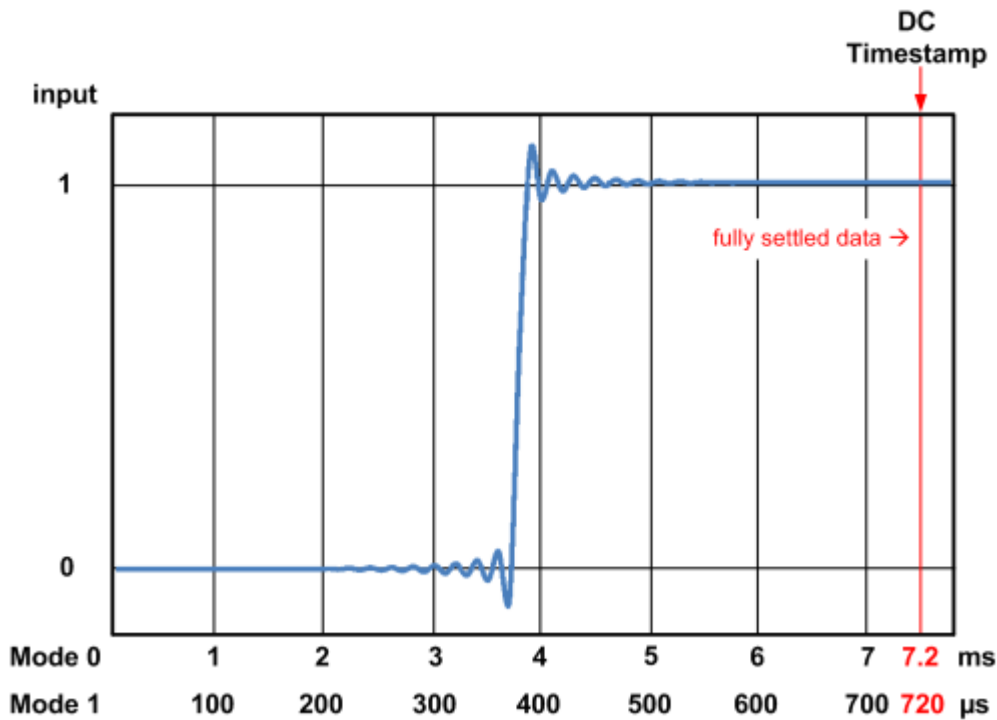

Fig. 4: Latency of the Analog-to-Digital converter

It is not possible to change the specified latency.

Beyond that the following are individually adjustable in each mode via CoE

- activation of the averager
- activation of the filter
- type of filter

8000:0	RMB Settings	RW	> 50 <
8000:01	Mode0 enable filter	RW	TRUE
8000:02	Mode1 enable filter	RW	TRUE
8000:03	Mode0 enable averager	RW	TRUE
8000:04	Mode1 enable averager	RW	TRUE
8000:05	Symmetric reference potential	RW	TRUE
8000:11	Mode0 filter settings	RW	FIR 50 Hz (0)
8000:12	Mode1 filter settings	RW	FIR 50 Hz (0)

Fig. 5: Setting parameters in CoE belonging to the individual modes

Mode change

In particular for dynamic weighing procedures it may make sense to considerably change the measuring characteristic during the weighing procedure. For example, if a bulk material is filled by the sack within 5 seconds, a very open filter should initially be used so that the measured value quickly follows the fill level. During this phase it is of no importance that the measured value is very inaccurate and subject to high fluctuations. If the sack is >90 % full, filling must be slowed down and the loading must be followed with higher accuracy; the filter must be closed. Therefore the two conversion modes can be switched via the process data bit "Sample mode" in the EPP3356-0022 in relation to the processing of the analog values.

The mode change takes about 30 ms, during which time the measured values are invalid and indicate this by the status byte.

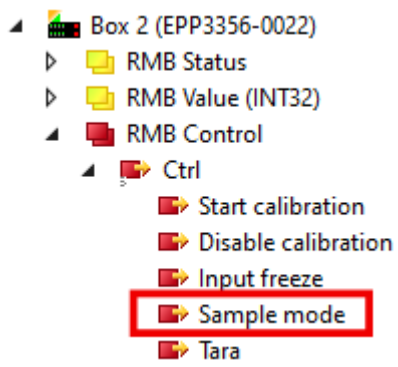
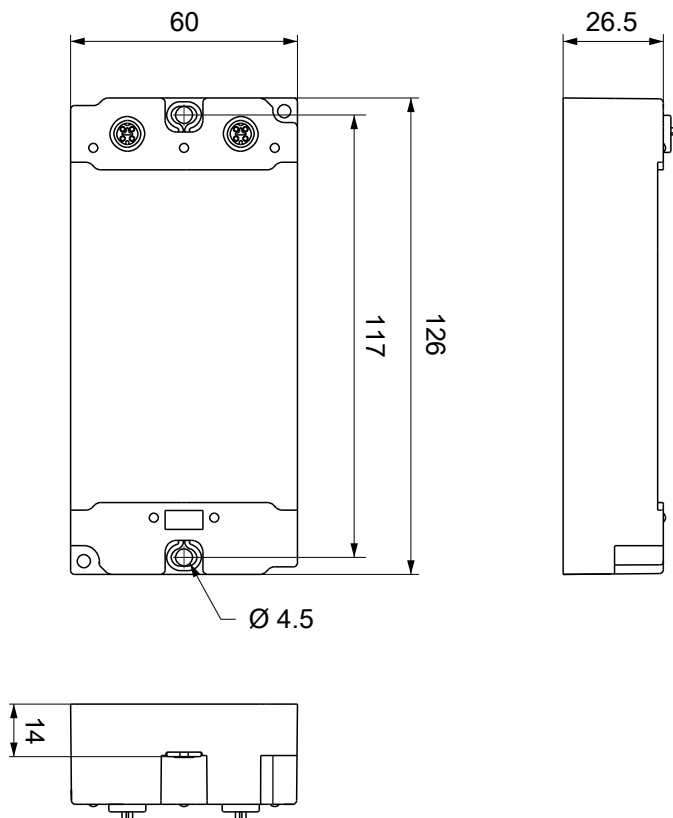

Fig. 6: Sample mode switching

5 Mounting and Cabling

5.1 Mounting

5.1.1 Dimensions



All dimensions are given in millimeters.
The drawing is not true to scale.

Housing features

Housing material	PA6 (polyamide)
Sealing compound	polyurethane
Mounting	two mounting holes Ø 4.5 mm for M4
Metal parts	brass, nickel-plated
Contacts	CuZn, gold-plated
Installation position	variable
Protection class	IP65, IP66, IP67 (conforms to EN 60529) when screwed together
Dimensions (H x W x D)	approx. 126 x 60 x 26.5 mm (without connectors)

5.1.2 Fixing

NOTICE

Dirt during assembly

Dirty connectors can lead to malfunctions. Protection class IP67 can only be guaranteed if all cables and connectors are connected.

- Protect the plug connectors against dirt during the assembly.

Mount the module with two M4 screws in the centrally located mounting holes.

5.1.3 Tightening torques for plug connectors

Screw connectors tight with a torque wrench. (e.g. ZB8801 from Beckhoff)

Connector diameter	Tightening torque
M8	0.4 Nm
M12	0.6 Nm

5.1.4 Functional earth (FE)

The mounting holes also serve as connections for the functional earth (FE).

Make sure that the box is grounded to low impedance via the functional earth (FE) connections. You can achieve this, for example, by mounting the box on a grounded machine bed.

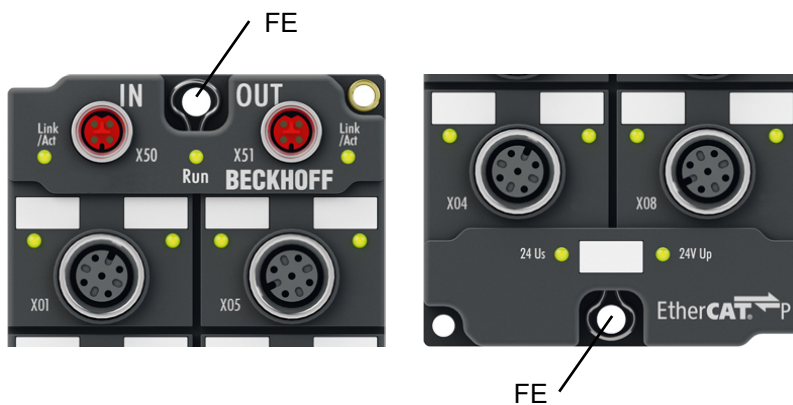

Fig. 7: Connection for functional earth (FE)

5.2 EtherCAT P

⚠ WARNING

Power supply from SELV/PELV power supply unit!

SELV/PELV circuits (Safety Extra Low Voltage, Protective Extra Low Voltage) according to IEC 61010-2-201 must be used to supply the EtherCAT P Power Sourcing Device (PSD).

Notes:

- SELV/PELV circuits may give rise to further requirements from standards such as IEC 60204-1 et al, for example with regard to cable spacing and insulation.
- A SELV (Safety Extra Low Voltage) supply provides safe electrical isolation and limitation of the voltage without a connection to the protective conductor, a PELV (Protective Extra Low Voltage) supply also requires a safe connection to the protective conductor.

⚠ CAUTION

Observe the UL requirements

- When operating under UL conditions, observe the warnings in the chapter .

EtherCAT P transmits two supply voltages:

- **Control voltage U_s**
The following sub-functions are supplied from the control voltage U_s :
 - the fieldbus
 - the processor logic
 - typically the inputs and the sensors if the EtherCAT P Box has inputs.
- **Peripheral voltage U_p**
The digital outputs are typically supplied from the peripheral voltage U_p for EtherCAT P Box modules with digital outputs. U_p can be supplied separately. If U_p is switched off, the fieldbus function, the function of the inputs and the supply of the sensors are maintained.

The exact assignment of U_s and U_p can be found in the pin assignment of the I/O connections.

Redirection of the supply voltages

The supply voltages are passed on internally from the "IN" connection to the "OUT" connection. Hence, the supply voltages U_s and U_p can be passed from one EtherCAT P Box to the next EtherCAT P Box in a simple manner.

NOTICE

Note the maximum current.

Ensure that the maximum permitted current of 3 A for the M8 connectors is not exceeded when redirecting EtherCAT P.

5.2.1 Connectors

NOTICE

Risk of damage to the device!
 Bring the EtherCAT/EtherCAT P system into a safe, powered down state before starting installation, disassembly or wiring of the modules!

Two M8 sockets at the upper end of the modules are provided for supply and downstream connection of EtherCAT P:

- IN: left M8 socket for EtherCAT P supply
- OUT: right M8 socket for downstream connection of EtherCAT P

The metal threads of the M8 EtherCAT P sockets are internally linked to the FE connection via high impedance RC combination. See chapter [Functional earth \(FE\)](#) [► 22].



Fig. 8: Connectors for EtherCAT P

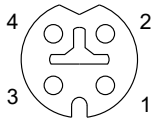

Fig. 9: M8 socket, P-coded

Contact	Signal	Voltage	Core color ¹⁾
1	Tx +	GND _S	yellow
2	Rx +	GND _P	white
3	Rx -	U _P : peripheral voltage, +24 V _{DC}	blue
4	Tx -	U _S : control voltage, +24 V _{DC}	orange
Housing	Shield	Shield	Shield

¹⁾ The core colors apply to EtherCAT P cables and ECP cables from Beckhoff.

5.2.2 Status LEDs

5.2.2.1 Supply voltage



Fig. 10: status-LEDs for the power supply

EtherCAT P Box modules indicate the status of the supply voltages via two status LEDs. The status LEDs are labeled with the designations of the supply voltages: U_s and U_p .

LED	Indicator	Meaning
U_s (control voltage)	Off	Power supply U_s is not present.
	Lights green	Power supply U_s is present.
U_p (peripheral voltage)	Off	Power supply U_p is not present.
	Lights green	Power supply U_p is present.

5.2.2.2 EtherCAT



Fig. 11: Status LEDs for EtherCAT

L/A (Link/Act)

A green LED labeled "L/A" or "Link/Act" is located next to each EtherCAT/EtherCAT P socket. The LED indicates the communication state of the respective socket:

LED	Meaning
off	no connection to the connected EtherCAT device
lit	LINK: connection to the connected EtherCAT device
flashes	ACT: communication with the connected EtherCAT device

Run

Each EtherCAT slave has a green LED labelled "Run". The LED signals the status of the slave in the EtherCAT network:

LED	Meaning
off	Slave is in "Init" state
flashes uniformly	Slave is in "Pre-Operational" state
flashes sporadically	Slave is in "Safe-Operational" state
lit	Slave is in "Operational" state

Description of the EtherCAT slave states

5.2.3 Conductor losses

Take into account the voltage drop on the supply line when planning a system. Avoid the voltage drop being so high that the supply voltage at the box lies below the minimum nominal voltage. Variations in the voltage of the power supply unit must also be taken into account.

i Planning tool for EtherCAT P

You can plan cable lengths, voltages and currents of your EtherCAT P system using TwinCAT 3. The requirement for this is TwinCAT 3 Build 4020 or higher.

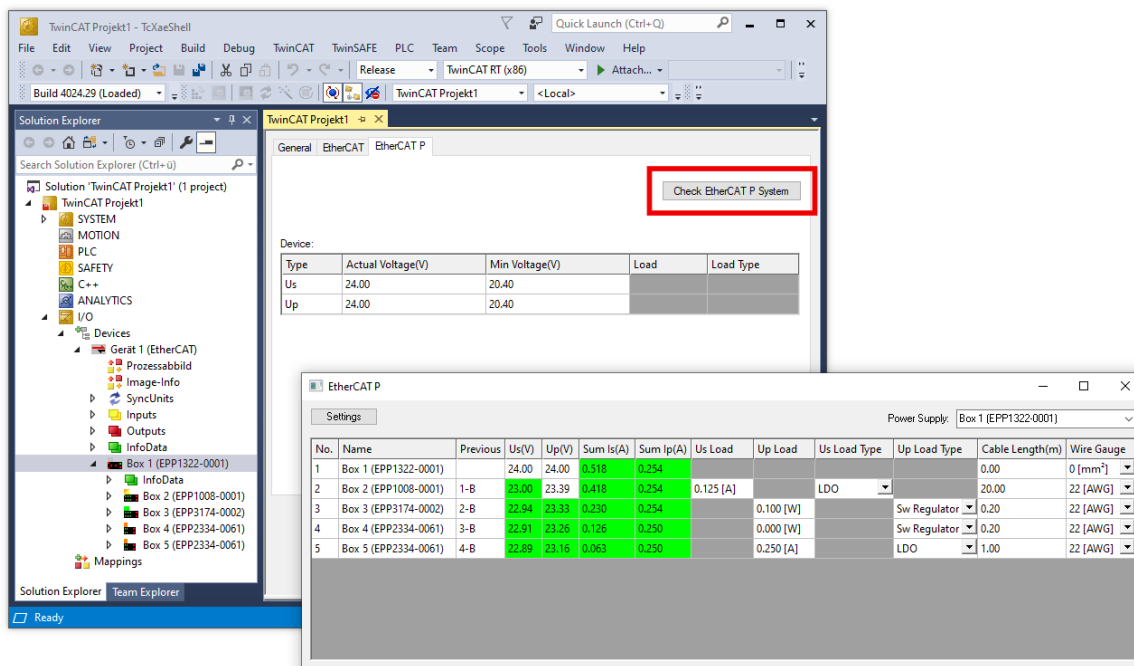

Further information can be found in the quick start guide [IO configuration in TwinCAT](#) in chapter "Configuration of EtherCAT P via TwinCAT".

Voltage drop on the supply line

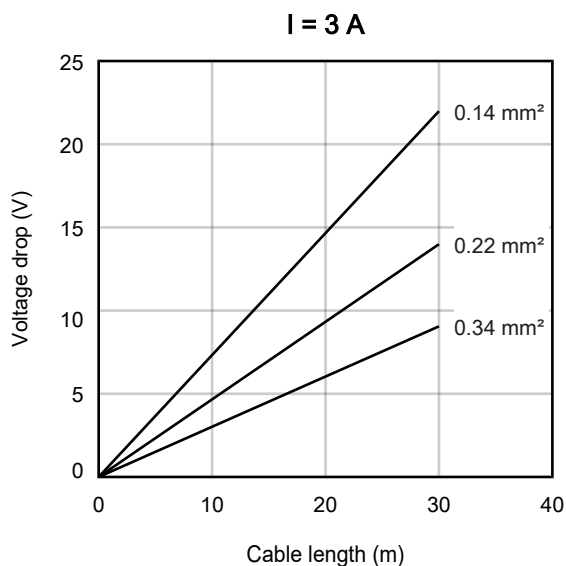

5.3 Resistor bridge

NOTICE

Measurement deviation due to incorrect shield connection
 If you are using a shielded cable, grounding the cable shield at the sensor end can lead to measurement deviations.

- Do not earth the cable shield at the sensor end.

The EPP3356-0022 enables the connection of a resistor bridge or load cell in 4-wire technique.

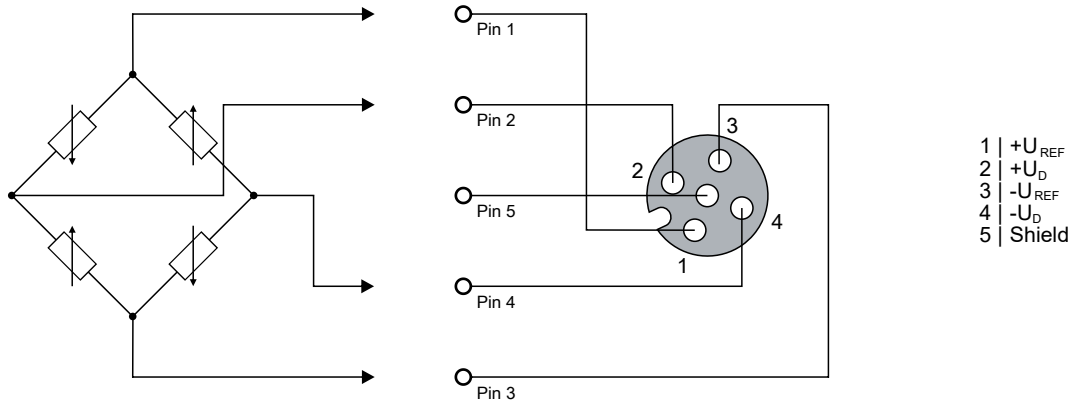

Connect the cable shield to pin 5 of the M12 connector.

The four M12 sockets of the EPP3356-0022 are internally connected to one another. Therefore, you can connect a resistor bridge to any M12 socket.

You can also connect several resistor bridges in parallel, see chapter Parallel connection of strain gauges.

The voltage U_{ref} is 10 V and is generated in the EPP3356-0022 from U_p .

Meaning of the LEDs

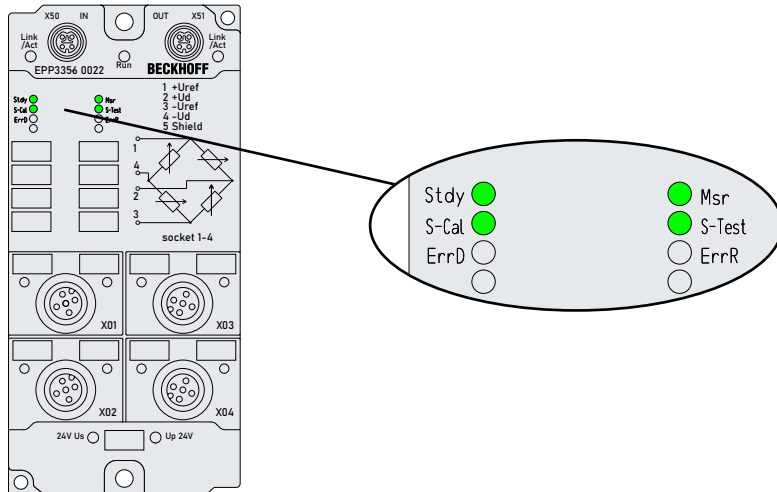

LED	Color	Meaning	
RUN	green	This LED indicates the operating state of the EtherCAT Box:	
		off	State of the EtherCAT State Machine: INIT = initialization of the EtherCAT Box.
		flashing	State of the EtherCAT State Machine: PREOP = function of the mailbox communication and different default settings set.
		single flash	State of the EtherCAT State Machine: SAFEOP = verification of the Sync Manager channels and the distributed clocks. Outputs remain in safe state.
		on	State of the EtherCAT State Machine: OP = normal operating state; mailbox and process data communication is possible.
fllickering	State of the EtherCAT State Machine: BOOTSTRAP = function for Firmware updates of the EtherCAT Box.		
Stdy	green	on	The measured value is stable
		off	The measured value is not stable
Msr	green	on	Measurement active (process data are valid)
		off	<ul style="list-style-type: none"> Self-calibration active (when the LED S-Cal lights up) or Self-test active (when the LED S-Test lights up) Filters are initialized
S-Cal	green	on	Self-calibration active <ul style="list-style-type: none"> The process data are not valid
S-Test	green	on	Self-test active <ul style="list-style-type: none"> The process data are not valid
ErrD	red	on	Channel 1 (strain gauge differential signal) outside the valid value range.
ErrR	red	on	Channel 2 (strain gauge reference signal) outside the valid value range. Possible reasons: <ul style="list-style-type: none"> The reference voltage U_{ref} is not available. Check whether the supply voltage U_p is present: U_{ref} is generated internally from U_p. The reference voltage U_{ref} has collapsed due to overload.

5.3.1 Parallel connection of strain gauges

It is usual to distribute a load mechanically to several strain gauge load cells at the same time. Hence, for example, the 3-point bearing of a silo container on 3 load cells can be realized. Taking into account wind loads and loading dynamics, the total loading of the silo including the dead weight of the container can thus be measured.

The mechanically parallel connected load cells are usually also electrically connected in parallel. As the four M12 sockets of the EPP3356-0022 are connected internally, an external parallel circuit is not necessary: if several load cells are connected to the EPP3356-0022, they are automatically connected in parallel. Up to four load cells can be connected.

The three load cells in the above example (silo container) can thus be connected to any three of the M12 sockets of the EPP3356-0022.

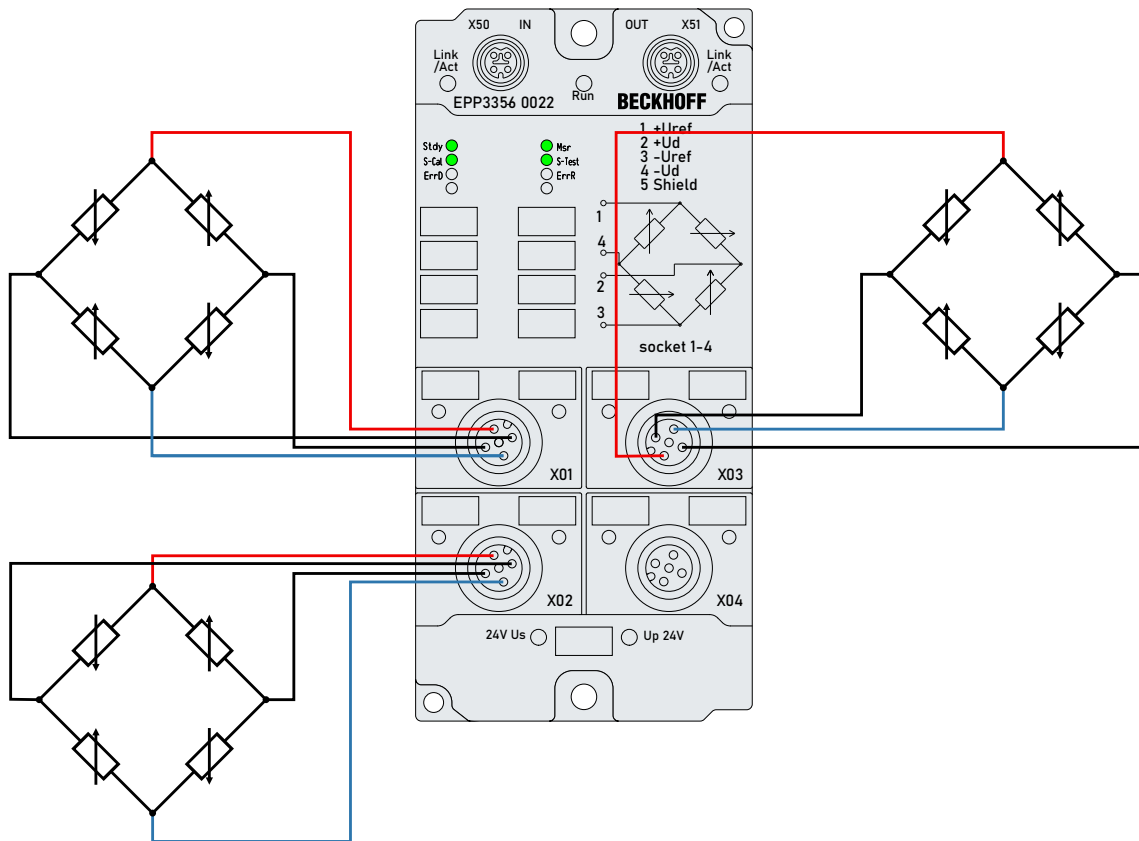

Note:

- the load cells must be matched to each other and approved by the manufacturer for this mode of operation
- the impedance of the load cells must be large enough that the maximum output current of the reference voltage U_{ref} is not exceeded: 350 mA.

5.4 Disposal



Products marked with a crossed-out wheeled bin shall not be discarded with the normal waste stream. The device is considered as waste electrical and electronic equipment. The national regulations for the disposal of waste electrical and electronic equipment must be observed.

6 Commissioning/Configuration

6.1 Integrating into a TwinCAT project

The procedure for integration in a TwinCAT project is described in these [Quick start guide](#).

6.2 Selection of the process data

The process data transferred by an EtherCAT slave during each cycle (Process Data Objects, PDOs) are user data which the application expects to be updated cyclically or which are sent to the slave. To this end the EtherCAT master (Beckhoff TwinCAT) parameterizes each EtherCAT slave during the start-up phase to define which process data (size in bits/bytes, source location, transmission type) it wants to transfer to or from this slave. Incorrect configuration can prevent successful start-up of the slave.

For Beckhoff EtherCAT EL/ES/EP slaves the following applies in general:

- The input/output process data supported by the device are defined by the manufacturer in the ESI/XML description. The TwinCAT EtherCAT Master uses the ESI description to configure the slave correctly.
- The process data can be modified in the system manager. See the device documentation. Examples of modifications include: Mask out a channel, displaying additional cyclic information, 16-bit display instead of 8-bit data size, etc.
- In so-called "intelligent" EtherCAT devices the process data information is also stored in the CoE directory. Any changes in the CoE directory that lead to different PDO settings prevent successful startup of the slave. It is not advisable to deviate from the designated process data, because the device firmware (if available) is adapted to these PDO combinations.

Proceed as follows to activate or deactivate individual PDOs.

1. Select the device to be configured at Solution Explorer.
2. Open the "Process Data" tab.
3. Select Sync Manager "Inputs" or "Outputs".
4. Activate or deactivate the PDOs.
 - ⇒ The activated PDOs appear as variables in the tree structure below the device at the Solution Explorer.
5. Optionally select a "Predefined PDO Assignment". "Predefined PDO Assignments" are useful predefined assemblies of process data objects.

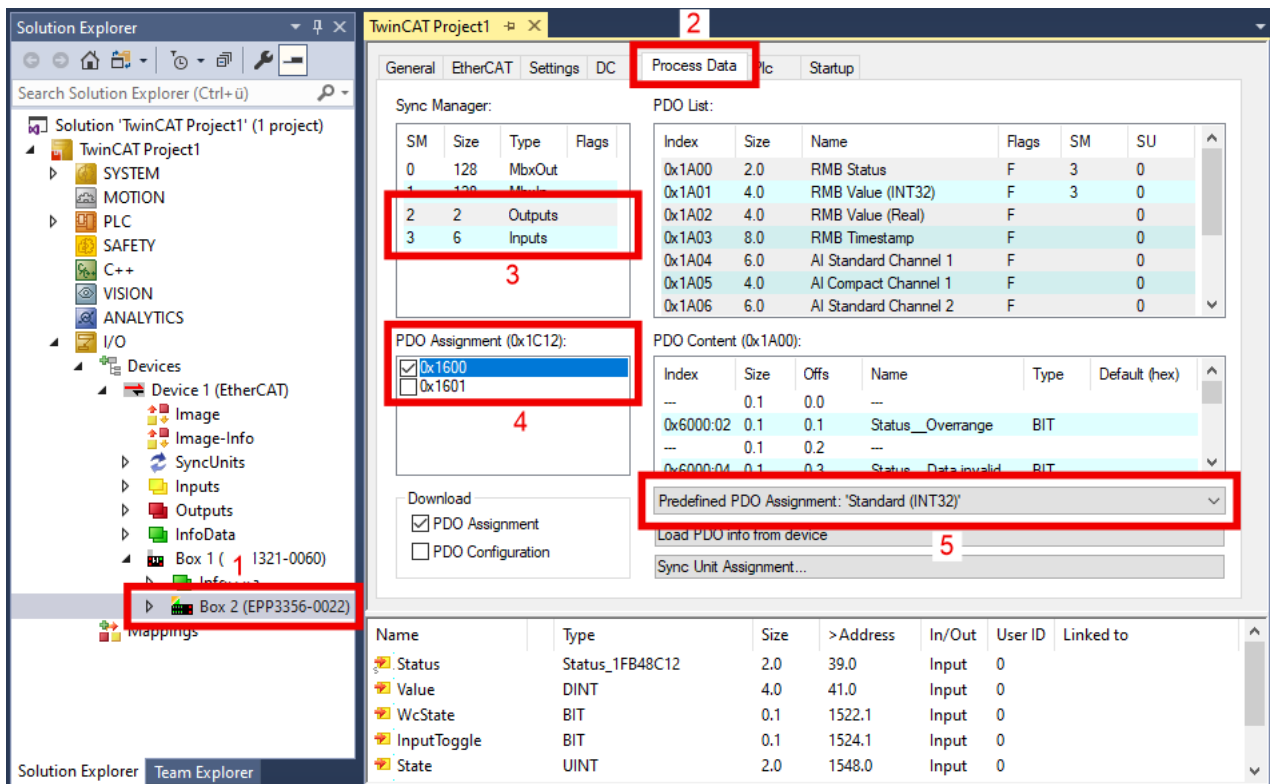

6.3 Application notes

Symmetric reference potential

The EPP3356-0022 measures the two voltages U_{supply} and U_{bridge} independently of each other. The measuring accuracy can be increased still further if an internal coupling is employed to prevent the internal measuring circuits from drifting apart. To this end the EPP3356-0022 has an internal switch that is closed in the default state and establishes a potential reference between the internal electronics and the bridge point.

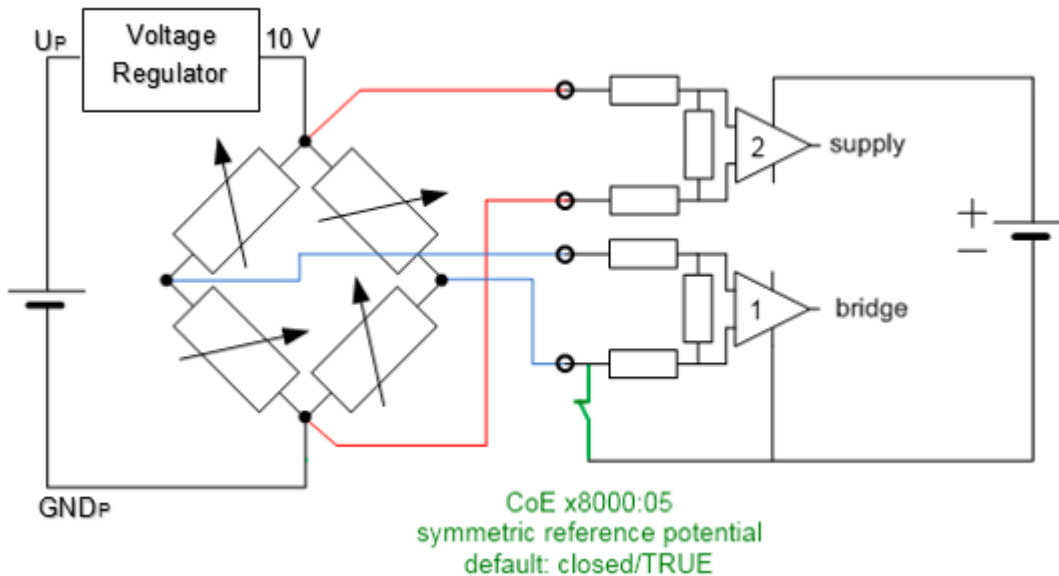

Fig. 12: Internal switch for increasing the measuring accuracy

If several strain gauges are supplied by the same power supply and equalising currents flow that falsify the measurement, the switch can be opened via CoE [0x8000:05](#) [[▶ 58](#)]. Alternatively, electrically isolated strain gauge supplies are to be installed.

Open-circuit recognition

The EPP3356-0022 has no express open-circuit recognition facility. If one of the bridge wires is broken, however, the voltage measured there generally moves towards the final value, thus displaying an error in the status word. Over/underrange of the supply voltage is likewise indicated.

Input freeze

If the box is placed in the freeze state by *InputFreeze* in the control word, no further analog measured values are relayed to the internal filter. This function is usable, for example, if a filling surge is expected from the application that would unnecessarily overdrive the filters due to the force load. This would result in a certain amount of time elapsing until the filter had settled again. The user himself must determine a sensible *InputFreeze* time for his filling procedure.

For clarification: temporal control of the *InputFreeze* and the decision regarding its use must be realised by the user in the PLC, they are not components of the EPP3356-0022.

In the following example (recorded with Scope2) impulses on a 15 kg load cell are recorded; the filter is wide open at IIR1 so that steep edges occur in the signal.



Fig. 13: Impulses on a load cell with and without InputFreeze

Explanation: The weight (A) is shown in blue; the state of the InputFreeze variable, which can be controlled by the PLC program and can be TRUE/FALSE, is shown in red (B). The first two impulses (C) lead to large peak deflections in the signal. After that the following is activated in the PLC program (see example program):

- if the measured value for the last cycle (cycle time 100 μ s) has changed by more than 10 g (indicating a sudden load), *blnputFreeze* is set to TRUE for 50 ms by a TOF block on the EPP3356-0022.

The effect can be seen in (D): The peak load is no longer acknowledged by the EPP3356-0022. If it is optimally adapted to the expected force impulse, the EPP3356-0022 can measure the current load value without overshoot.

Gravity adaption

The calculation of the weight depends on the gravitation/the Earth's gravitational force/acceleration due to gravity at the place of installation of the scales. In general, acceleration due to the gravitational pull of the earth at the place of installation is not equal to the defined standard value of $g = 9.80665 \text{ m/s}^2$. For example, 4 zones of acceleration due to gravity are defined in Germany, in which a local acceleration due to gravity of 9.807 m/s^2 to 9.813 m/s^2 is to be assumed. Hence, within Germany alone there is a clear dispersion of the order of parts per thousand for acceleration due to gravity, which has a direct effect on the measured weight in accordance with the equation $F_g = m \cdot g$.

If

- load cells are used in the theoretical calibration with characteristic values according to the sensor certificate
- calibration weights are used whose weight at the place of installation of the scales is by nature different to that at the place of origin
- scales of the accuracy class I to III are to be realized
- scales that are generally independent of acceleration due to gravity are to be realized

then one should check whether the gravity correction needs to be adapted via object [0x8000:26](#) [▶ 58](#).

Idling recognition

Weighing is a dynamic procedure that can lead to large jumps in the bridge voltage and thus to the calculation of the value. Following a change in load, the measured value must first "settle" so that the process value is evaluable in the controller. The evaluation of the measured value and the decision over the degree of calmness can be done in the controller; however, the EPP3356-0022 also offers this function, which is activated by default. The result is output in the status word.

- If the load value remains within a range of values y for longer than time x , then the *SteadyState* is activated in the *StatusWord*.
- *SteadyState* is set to FALSE as soon as this condition no longer applies.
- The parameters x and y can be specified in the CoE
- The evaluation is naturally considerably affected by the filter setting

In the following example (recorded with TwinCAT Scope2), a 15 kg load cell is abruptly unloaded and then loaded again with 547 g. *SteadyState* is subject to a window time from 100 ms and a tolerance of 8 g (15 kg nominal value, scaling 1000; see CoE).

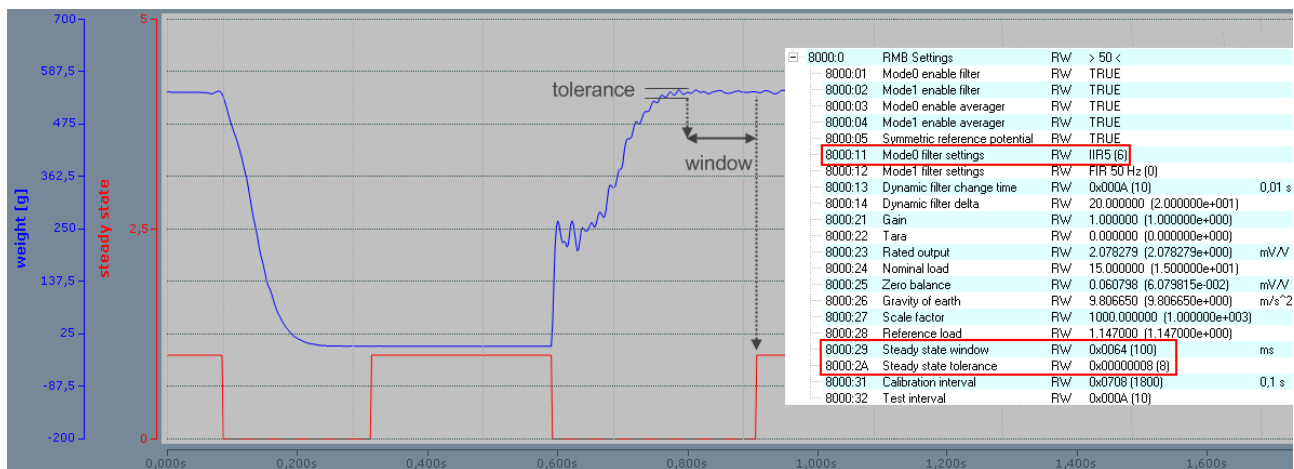

Fig. 14: Abrupt unloading and subsequent reloading of a load cell

Official calibration capability

"Official calibration" is a special kind of calibration that is accomplished according to special regulations with the involvement of trained personnel using prescribed aids. The use of "officially calibrated" scales is mandatory in the Central European region, in particular for the filling of foodstuffs. This ensures the correctness of the weighed quantities in a particular way.

The EPP3356-0022 cannot be officially calibrated as individual device. However, it can be integrated as element in applications that can then be equipped by the integrator with the required characteristics for official calibration capability using appropriate means.

6.4 Calibration and adjustment

The term "calibration" can be applied in 3 different ways to the EPP3356-0022:

- Sensor calibration: once-only calibration of the employed sensor (strain gauge) during commissioning of the system
- Self-calibration: continuously repeated self-calibration of the box for the improvement of the measuring accuracy
- Tare: repeated gross/net compensation by taring

Sensor calibration

The EPP3356-0022 is matched to the characteristic curve of the sensor element by means of the calibration. Two values are required for this procedure: the initial value without a load ("zero balance") and fully loaded ("rated output"). These values can be determined by a calibration protocol or by a calibration using calibration weights.

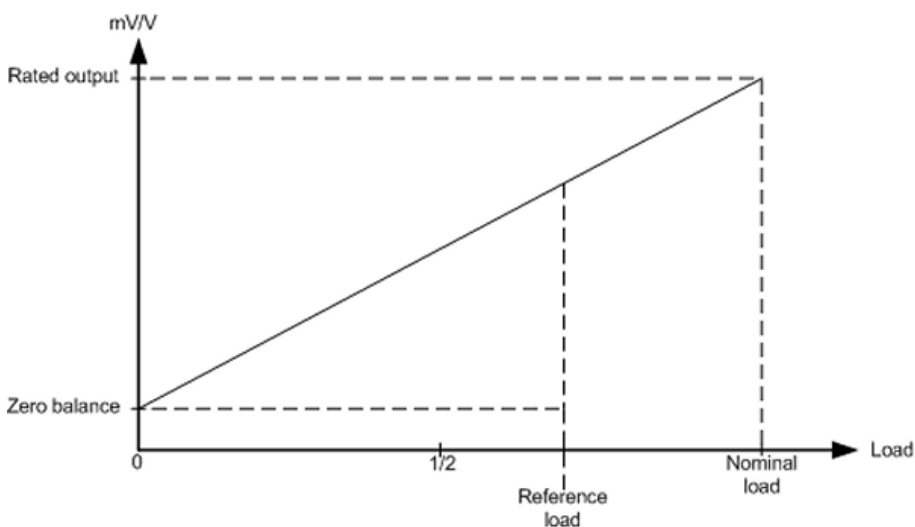

Fig. 15: Adaptation to the sensor curve

Calibration by means of compensation in the system

In the "practical" calibration, measurement takes place first with the scales unloaded, then with a defined load on the scales. The EPP3356-0022 automatically calculates the existing sensor characteristic values from the measured values.

Sequence:

1. Perform a CoE reset with object 0x1011:01, see Restoring the delivery state
2. Set scale factor to 1000 (0x8000:27 [► 58]) (for declaration of weight in g)
3. Set gravity of earth (0x8000:26 [► 58]) if necessary (default: 9.806650)
4. Set gain to (0x8000:21 [► 58]) = 1
5. Set tare to 0 (0x8000:22 [► 58])
6. Set the filter (0x8000:11 [► 58]) to the strongest level: IIR8
7. Specify the nominal load of the sensor in 0x8000:24 [► 58] ("Nominal load")

8. Zero balance: Do not load the scales. As soon as the measured value indicates a constant value for at least 10 seconds, execute the command "0x0101" (257_{dec}) on CoE object 0xFB00:01 [▶ 56]. This command causes the current mV/V value (0x9000:11 [▶ 58]) to be entered in the "Zero balance" object. Check: CoE objects 0xFB00:02 [▶ 56] and 0xFB00:03 [▶ 56] must contain "0" after execution

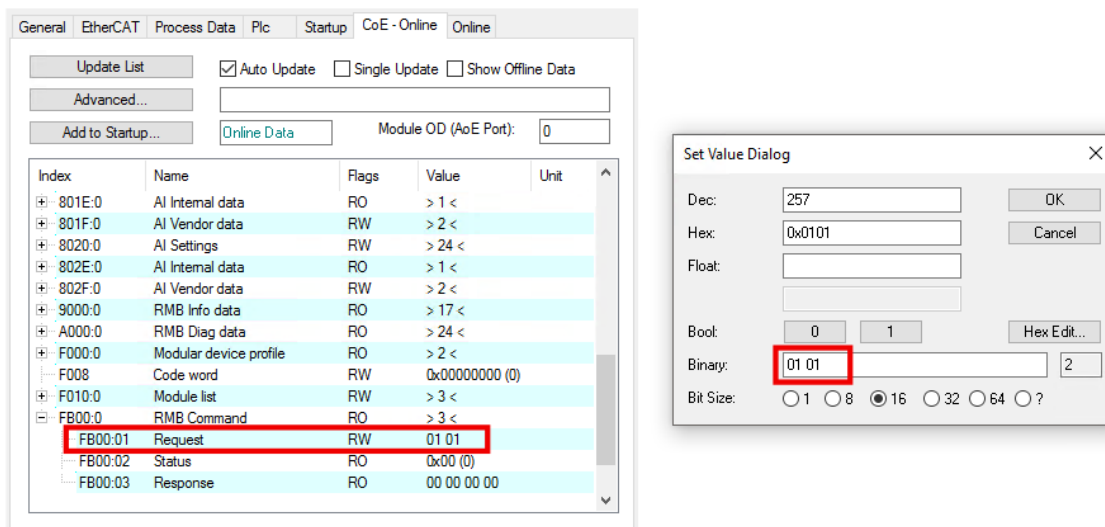

9. Load the scales with a reference load. This should be at least 20 % of the rated load. The larger the reference load, the better the sensor values can be calculated. In object 0x8000:28 [▶ 58] ("Reference load"), enter the load in the same unit as the rated load (0x8000:24 [▶ 58]). As soon as the measured value indicates a constant value for at least 10 seconds, execute the command "0x0102" (258_{dec}) on CoE object 0xFB00:01 [▶ 56]. By means of this command the EPP3356-0022 determines the output value for the nominal weight ("Rated output") Check: CoE objects 0xFB00:02 [▶ 56] and 0xFB00:03 [▶ 56] must contain "0" after execution.

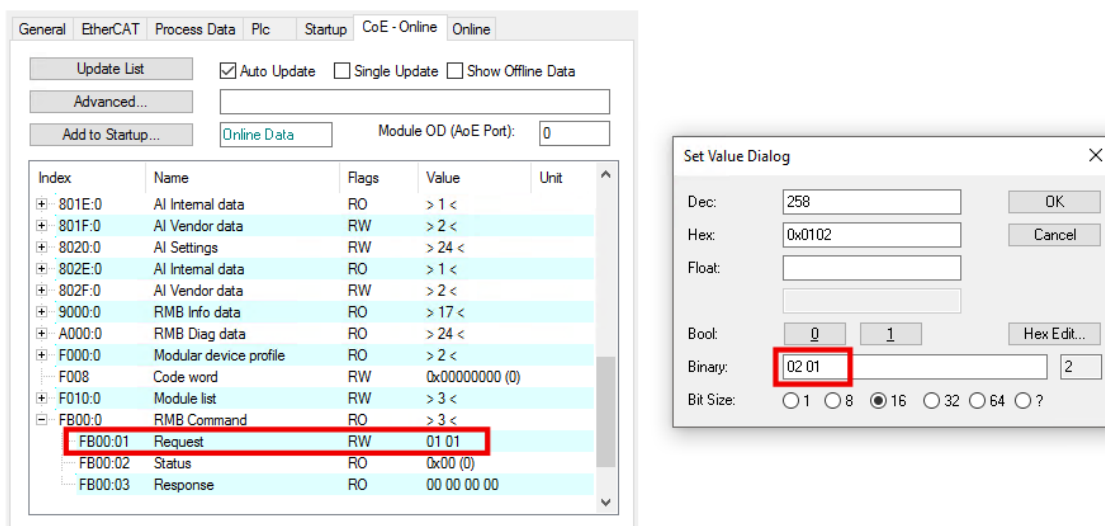

10. Reset: execute the command "0x0000" (0_{dec}) on CoE object 0xFB00:01 [▶ 56].
 11. Set the filter to a lower stage.

Calibration according to the sensor calibration protocol (theoretical calibration)

The sensor characteristic values according to the manufacturer's certificate are communicated here directly to the EPP3356-0022, so that it can calculate the load.

1. Perform a CoE reset with object 0x1011:01, see Restoring the delivery state
2. Set scale factor to 1000 (0x8000:27 [▶ 58]) (for declaration of weight in g)

3. Set gravity of earth (0x8000:26 [► 58]) if necessary (default: 9.806650)
4. Set gain to (0x8000:21 [► 58]) = 1
5. Set tare to 0 (0x8000:22 [► 58])
6. Specify the nominal load of the sensor in 0x8000:24 [► 58] ("Nominal load")
7. Adopt the "Rated output" (mV/V value 0x8000:23 [► 58]) from the calibration protocol
8. Adopt the "Zero balance" (0x8000:25 [► 58]) from the calibration protocol

● Calibration

i The calibration is of great importance for the accuracy of the system. In order to increase this, the filter should be set as strong as possible over the entire calibration phase. It may take several seconds before a static value is obtained.

● Local storage

i The values modified during the theoretical and practical calibration are stored in a local EEPROM. This can be written to up to 1 million times. In order to prolong the life of the EEPROM, therefore, the commands should not be executed cyclically.

Self-calibration of the measuring amplifiers

The measuring amplifiers are periodically subjected to examination and self-calibration. Several analog switches are provided for this purpose, so that the various calibration signals can be connected. It is important for this process that the entire signal path, including all passive components, is examined at every phase of the calibration. Only the interference suppression elements (L/C combination) and the analog switches themselves cannot be examined. In addition, a self-test is carried out at longer intervals.

The self-calibration is carried out every 3 minutes in the default setting.

Self-calibration

- The time interval is set in 100 ms steps with object 0x8000:31 [► 58]; default: 3 min. Duration approx. 150 ms

Self-test

- is additional carried out together with every nth self-calibration. The multiple (n) is set with object 0x8000:32 [► 58]; default: 10 additional duration approx. 70 ms.

By means of the self-calibration of the input stages at the two operating points (zero point and final value), the two measuring channels are calibrated to each other.

Interface for controller

The self-calibration takes place automatically at the defined intervals. In order to prevent calibration during a time-critical measurement, the automatic calibration can be disabled via the "Disable calibration" bit in *ControlWord*, also permanently. If it should be additionally necessary to carry out a manual test, this is started by a rising edge of the "*Start manual calibration*" bit in the process image.

While the box is performing a self-calibration or a self-test, the "*Calibration in progress*" bit is set in the process image. Once started, a self-calibration/self-test cannot be aborted.

If the self-calibration has been disabled by "Disable calibration", it can nevertheless be started by the "Start calibration" process data bit.

● Self-calibration

i The self-calibration takes place for the first time directly after starting up the box. At this point the external reference voltage must already be applied. If the reference voltage is only applied later, the self-calibration must be manually initiated (process data bit: „*Start calibration*“). The self-calibration must be executed at least once after each start-up. The supply voltage must be applied during the self-calibration, since otherwise the necessary reference voltages cannot be generated. A lower measuring accuracy is to be expected if the self-calibration is disabled for a longer period or permanently.

After a change of the settings in the CoE (range x80nn), a self-calibration will be executed in each case (also for *DisabledCalibration* = TRUE), because the settings have an influence to the measuring procedure. CoE settings should be done as far as possible out of running measuring procedures.

Taring

When taring, the scales are "zeroed" using an arbitrary applied load; i.e. an offset correction is performed. This is necessary for the gross/net compensation of goods that cannot be weighed without a container that has a mass of its own.

The EPP3356-0022 supports 2 tarings; it is recommended to set a strong filter when taring.

Temporary tare

- The correction value is NOT stored in the box and is lost in the event of a power failure. To this end the command "0x0001" is executed on CoE object 0xFB00:01 [▶ 56] (binary dialog in the System Manager: "01 00"). This sets the tare object (0x8000:22 [▶ 58]) such that the display value is 0. Note: in the case of a device restart (INIT → OP) the tare is not deleted. In addition this tare can be executed via the control word:

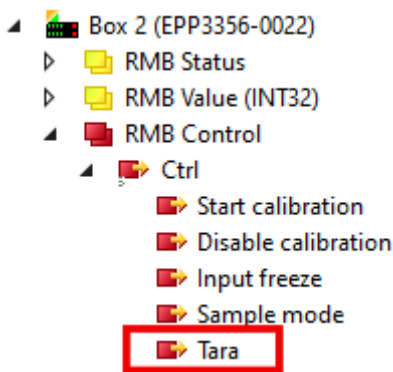

Permanent tare

- The correction value is stored locally in the boxes EEPROM and is not lost in the event of a power failure. To this end the command "0x0002" is executed on CoE object 0xFB00:01 [▶ 56] (binary dialog in the System Manager: "02 00"). This sets the tare object (0x8000:22 [▶ 58]) such that the display value is 0.

Local storage

The values modified during the theoretical and practical calibration are stored in a local EEPROM. This can be written to up to 1 million time. In order to prolong the life of the EEPROM, therefore, the commands should not be executed cyclically.

Commands

The functions discussed above are carried out by means of commands in the standardized object 0xFB00 [▶ 56].

Index	Name	Comment
FB00:01	Request	Entry of the command to be executed
FB00:02	Status	Status of the command currently being executed 0: Command executed without error 255: Command is being executed
FB00:03	Response	Optional response value of the command

The function blocks *FB_EcCoESdoWrite* and *FB_EcCoESdoRead* from the *TcEtherCAT.lib* (contained in the standard TwinCAT installation) can be used in order to execute the commands from the PLC.

Commands of the EPP3356-0022

The following commands can be transferred to the box via the CoE entry 0xFB00:01 [► 56].

Command	Comment
0x0101	Execute zero balance
0x0102	Execute calibration
0x0001	Execute tare procedure (value is NOT saved in the boxes EEPROM)
0x0002	Execute tare procedure (value is saved in the boxes EEPROM)

6.5 Voltage measurement

The EPP3356-0022 principally offers a 2-channel voltage measurement on one box with two very different measuring ranges of ± 25 mV and ± 12 V nominal voltage. The load on the one connected strain gauge can be calculated from the two simultaneously measured voltages; the EPP3356-0022 already performs this calculation in the box and thus represents a 1-channel box in the sense of load calculation.

The following applies to the individual channels:

- Channel 1:
 - Typical measuring range approx. -13.5 V to 0 to +13.5 V (equivalent to process value 0x80.00.00.00 to 0 to 0x7F.FF.FF.FF)
 - Nominal measuring range: -12 V... 0 ... +12 V
 - max. permissible voltage $-U_D$ vs. $+U_D$: ± 13.5 V
 - Measuring error $< \pm 0.1$ % of the full scale value, 50 Hz filter active
- Channel 2:
 - Typical measuring range approx. -27 mV to 0 to +27 mV (equivalent to process value 0x80.00.00.00 to 0 to 0x7F.FF.FF.FF)
 - Nominal measuring range: -25 mV... 0 ... +25 mV
 - max. permissible voltage $-U_{ref}$ vs. $+U_{ref}$: ± 27 mV
 - Measuring error $< \pm 0.1$ % of the full scale value, 50 Hz filter active
- in strain gauge mode the connected strain gauge guarantees that no impermissibly high potential differences arise inside and outside the circuit.

In the standard setting the EPP3356-0022 operates as a 1-channel strain gauge monitor with the [process image](#) [[▶ 44](#)]; the box can be switched to 2-channel voltage measurement by changing the process data. See the notes on the process image regarding this. If the EPP3356-0022 is not used as a load measuring box, but rather as a 2-channel analog input measuring box, the following must be observed:

- The CoE settings are to be found for:
 - Channel 1: objects under [0x8010:xx](#) [[▶ 56](#)]
 - Channel 2: objects under [0x8020:xx](#) [[▶ 56](#)]
 - the strain gauge objects under [x8000:xx](#) have no function. Exception: the averager ([0x8000:03](#) [[▶ 58](#)]) can also be used in voltage measuring mode and applies to both channels simultaneously.
- Self-calibration is not possible and useful.
- The two analog channels are not calibrated by the manufacturer, since this is not required for the relative measurement in strain gauge mode. This means, for example, for channel 1 with a nominal measuring range of ± 12 V or a typical measuring range of ± 13.5 V, that the maximum measured value 0x7F.FF.FF.FF can be output by one box for example as 13.4 V and by another as 13.6 V. If several EPP3356-0022 are to output identical process values for identical applied voltages, meaning that they are exchangeable, each channel must be calibrated by the user by making settings for each channel in the CoE. The user calibration (CoE [0x80n0:17](#) [[▶ 56](#)] [offset], [0x80n0:18](#) [[▶ 56](#)] [gain]) or the user scaling (CoE [0x80n0:11](#) [[▶ 56](#)] [offset], [0x80n0:12](#) [[▶ 56](#)] [gain]) can be used for this.

i Voltage measurement

In the voltage measuring mode the **EL3356** is to be connected to external GND with a single-ended connection. In addition the internal GND reference is to be closed by the CoE switch *SymmetricReferencePotential*. The EPP3356-0022 “supply” is not usable because the box internally

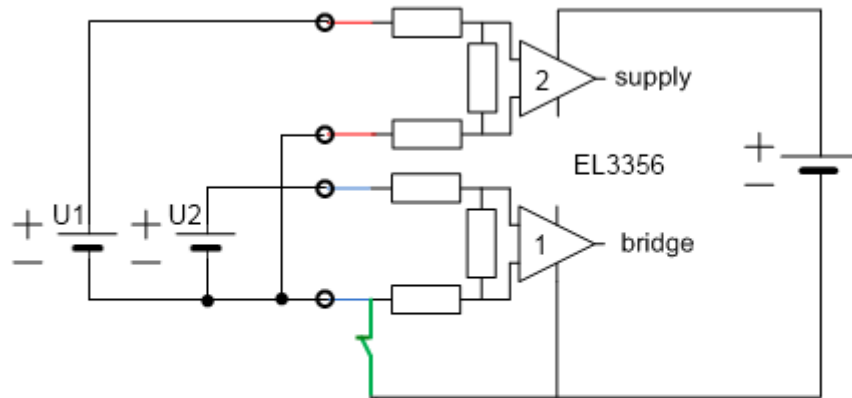

CoE x8000:05
symmetric reference potential
default: closed/TRUE

generated 10 V.

6.6 Distributed Clocks mode

In the Distributed Clocks mode (DC mode), the precise timestamp is recorded for each measured value and transmitted to the controller as cyclic process data. To this end

- DC must be activated. To do this, select DC-Synchron (input based) on the "DC" tab

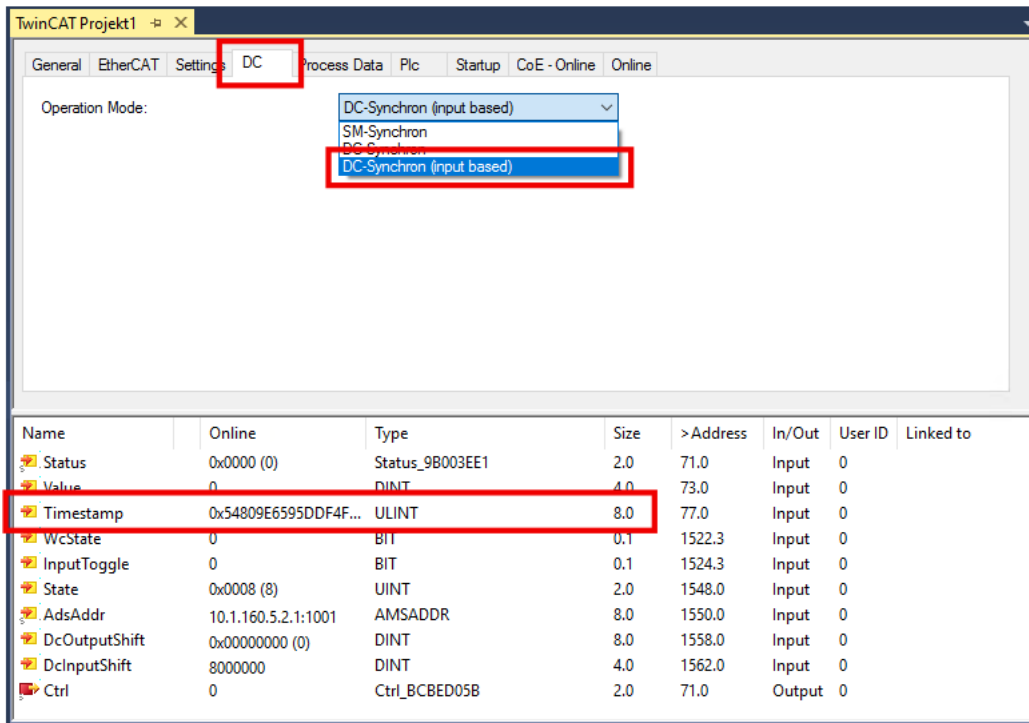

- The PDO x1A03 in the [Process data management \[► 44\]](#) is to be activated in the SyncManager 3 "Inputs"

The EPP3356-0022 operates free running with a cyclic, but not equidistant measurement; the time intervals between 2 measured values are therefore not constant. For this reason the 64-bit timestamp delivered with the process value must be evaluated by the user.

In order to suppress falsification of the measurement results by upstream filters, both the software filter and the averager are deactivated in this operating mode. The measurement/calculation and provision of the measured value in the process data therefore takes place at the conversion rate corresponding to the mode: 10.5 kSps or 105.5 kSps

Time stamp

See Notes on [latency regarding \[► 13\]](#) the time when the actual timestamp is acquired.

6.7 Process data

This section describes the individual PDOs and their content. A PDO (Process Data Object) is a unit on cyclically transmitted process values. Such a unit can be an individual variable (e.g. the weight as a 32-bit value) or a group/structure of variables. The individual PDOs can be activated or deactivated separately in the TwinCAT System Manager. The "Process data" tab is used for this (visible only if the box is selected on the left). A change in the composition of the process data in the TwinCAT System Manager becomes effective only after restarting the EtherCAT system.

The EPP3356-0022 can be used in 2 basic operating modes

- 1-channel strain gauge evaluation (strain gauge, balance beam, load cell): Here, both analog input voltages are measured internally, they are calculated locally according to the internal settings in the box and the resulting load value is output to the controller as a cyclic process value. The box is to be regarded as a 1-channel box. The load value can be output as an integer or as a float/real representation.
- 2-channel voltage measurement: Both analog input voltages are output directly as process values; no load calculation takes place. The value and status information can be output for each channel.

The basic operating mode of the EPP3356-0022 is determined by the selection of the process data (PDO). The procedure for the selection of the process data can be found in chapter [Selection of the process data](#) [► 32].

Predefined PDO Assignment

In order to simplify the configuration, typical configuration combinations of process data are stored in the device description. The predefined configurations can be selected in the process data overview. Therefore the function is available only if the ESI/XML files are saved in the system.

The following combinations are possible:

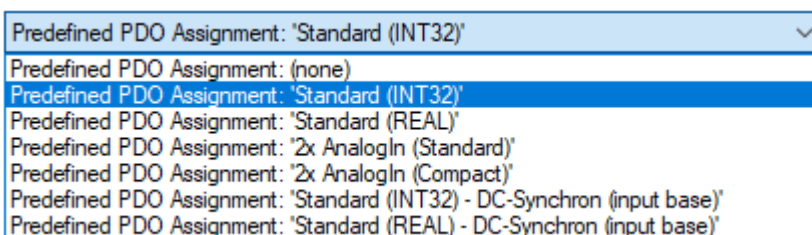

- *Standard (INT32): [Default setting] load calculation; 32-bit integer load value as final value according to the calculation specifications in the CoE, no further conversion necessary in the PLC*
- *Standard (REAL): Load calculation; 32-bit floating-point load value as final value according to the calculation specifications in the CoE, no further conversion necessary in the PLC*
- *2x AnalogIn (Standard): 2-channel voltage measurement, 32-bit integer voltage value with additional information (under-range, over-range, error, TxPdoToggle)*
- *2x AnalogIn (Compact): 2-channel voltage measurement, 32-bit integer voltage value only*

Default process image

The default process image is standard (INT32).

Name	Online	Type	Size	> Address	In/Out	User ID	Linked to
[-] Status	0x0000 (0)	Status_9B003EE1	2.0	39.0	Input	0	
[-] Overrange	0	BIT	0.1	39.1	Input	0	
[-] Data invalid	0	BIT	0.1	39.3	Input	0	
[-] Error	0	BIT	0.1	39.6	Input	0	
[-] Calibration in progress	0	BIT	0.1	39.7	Input	0	
[-] Steady state	0	BIT	0.1	40.0	Input	0	
[-] Sync error	0	BIT	0.1	40.5	Input	0	
[-] TxPDO Toggle	0	BIT	0.1	40.7	Input	0	
[-] Value	0	DINT	4.0	41.0	Input	0	
[-] WcState	1	BIT	0.1	1522.1	Input	0	
[-] InputToggle	0	BIT	0.1	1524.1	Input	0	
[-] State	97	UINT	2.0	1548.0	Input	0	
[-] AdsAddr	10.1.160.5.2.1:1001	AMSADDR	8.0	1550.0	Input	0	
[-] netId	10.1.160.5.2.1	AMSNETID	6.0	1550.0	Input	0	
[-] port	0x03e9	WORD	2.0	1556.0	Input	0	
[-] Ctrl	0x0000 (0)	Ctrl_BCBED05B	2.0	39.0	Output	0	
[-] Start calibration	0	BIT	0.1	39.0	Output	0	
[-] Disable calibration	0	BIT	0.1	39.1	Output	0	
[-] Input freeze	0	BIT	0.1	39.2	Output	0	
[-] Sample mode	0	BIT	0.1	39.3	Output	0	
[-] Tara	0	BIT	0.1	39.4	Output	0	

Function of the variables**Variable:** Status**Meaning:** The status word (SW) is located in the input process image, and is transmitted from box to the controller.

Bit	SW. 15	SW. 14	SW. 13	SW. 12	SW. 11	SW. 10	SW. 9	SW. 8	SW. 7	SW. 6	SW. 5	SW. 4	SW. 3	SW. 2	SW. 1	SW. 0
Name	TxPDO Toggle	-	Sync Error	-	-	-	-	Steady State	Calibration in progress	Error	-	-	Data invalid	-	Overrange	-
Meaning	Toggles 0→1→0 with each updated data set	-	Synchronisation error					Idling recognition [▶ 33]	Calibration [▶ 36] in progress	Collective error display	-	-	Input data are invalid	-	Measuring range exceeded	-

Variable: Value**Meaning:** Calculated 32-bit DINT load value in unit [1], with sign**Variable:** Value (Real)**Meaning:** Calculated 32-bit fixed point REAL load value with mantissa and exponent in unit [1]

The format matches the REAL format of IEC 61131-3, which in turn is based on the REAL format of IEC 559. A REAL number (single precision) is defined as follows (See also Beckhoff InfoSys: [TwinCAT PLC Control: standard data types](#)). In accordance with IEC 61131 this 32-bit variable can be directly linked with a FLOAT variable of the PLC.

Bitposition (from the left)	1	8	23 (+1 „hidden bit“, see IE559)
Function	Sign	Exponent	Mantissa

Variable: WcState**Meaning:** Cyclic diagnostic variable; „0“ indicates correct data transmission**Variable:** Status**Meaning:** State of the EtherCAT device; State.3 = TRUE indicates correct operation in OP**Variable:** AdsAddr**Meaning:** AmsNet address of the EtherCAT device from AmsNetId (in this case: 192.168.0.20.5.1) and port (in this case: 1003)

Variable: Ctrl

Meaning: The control word (CW) is located in the output process image, and is transmitted from the controller to the box.

Bit	CW. 15	CW. 14	CW. 13	CW. 12	CW. 11	CW. 10	CW. 9	CW. 8	CW. 7	CW. 6	CW. 5	CW. 4	CW. 3	CW. 2	CW. 1	CW. 0
Name												Tara	Sample Mode	Input Freeze	Disable Calibration	Start Calibration
Meaning												starts tare [▶ 54]	mode switching (EL3356-010 and EP3356-0022only) [▶ 36]	stops the measurement [▶ 33]	Switches the automatic self-calibration [▶ 36] off	Starts the self-calibration [▶ 36] immediately

See also the example program for the dissection of the Status and CTRL variable.

Variants (Predefined PDO)

Fixed-point representation of the load

The display of the load value can also be converted already in the box into a point representation. To do this the input PDOs are to be changed as follows:

The screenshot shows the TwinCAT configuration interface. In the 'PDO List' section, the entry for index 0x1A00 (size 2.0, name 'RMB Status') is highlighted. In the 'PDO Content' section, the entry for index 0x6000:02 (size 0.1, name 'Status_Overrange') is highlighted. A red box highlights the 'Predefined PDO Assignment: Standard (REAL)' dropdown menu. Below the configuration area, a table lists the resulting variables:

Name	Online	Type	Size	>Address	In/Out	User ID	Linked to
Status	0x0000 (0)	Status 9B003EE1	2.0	39.0	Input	0	
Value (Real)	0.0	REAL	4.0	41.0	Input	0	
WcState	1	BIT	0.1	1522.1	Input	0	
InputToggle	0	BIT	0.1	1524.1	Input	0	
State	97	UINT	2.0	1548.0	Input	0	
AdsAddr	10.1.160.5.2.1:1001	AMSADDR	8.0	1550.0	Input	0	
Ctrl	0x0000 (0)	Ctrl_BCBED05B	2.0	39.0	Output	0	

Variable: Value (Real)

Meaning: Calculated 32-bit fixed point REAL load value with mantissa and exponent in unit [1]

The format matches the REAL format of IEC 61131-3, which in turn is based on the REAL format of IEC 559. A REAL number (single precision) is defined as follows (See also Beckhoff InfoSys: TwinCAT PLC Control: [standard data types](#)). This 32-bit variable can be linked directly with a FLOAT variable of the PLC according to IEC61131.

Bit position (from left)	1	8	23 (+1 „hidden bit“, see IEC 559)
Function	Sign	Exponent	Mantissa

Voltage measurement

The EPP3356-0022 can also be used as a 2-channel analog input box for voltage measurement, see [Notes \[▶ 41\]](#).

The screenshot displays the configuration for an AI Standard Channel 1. The 'PDO Assignment' panel shows that PDO 0x1600 is selected. The 'PDO Content' table lists the following entries:

Index	Size	Offs	Name
---	0.1	0.0	---
0x6000:02	0.1	0.1	Status__Overrange
---	0.1	0.2	---

The main table below lists the variables for the channel:

Name	Online	Type	Size	>Addr...	In/Out	User ID
Underrange	0	BIT	0.1	39.0	Input	0
Overrange	0	BIT	0.1	39.1	Input	0
Error	0	BIT	0.1	39.6	Input	0
TxPDO Toggle	1	BIT	0.1	40.7	Input	0
Value	1534251392	DINT	4.0	41.0	Input	0
Underrange	0	BIT	0.1	45.0	Input	0
Overrange	0	BIT	0.1	45.1	Input	0
Error	0	BIT	0.1	45.6	Input	0
TxPDO Toggle	1	BIT	0.1	46.7	Input	0
Value	36086140	DINT	4.0	47.0	Input	0

Variable	Meaning
Underrange	Measurement is below range
Overrange	Measuring range exceeded
Error	Collective error display
TxPDO Toggle	Toggles 0→1→0 with each updated data set
Value	Right-justified voltage value over the respective measuring range (Range of values 0x80.00.00.00...0...0x7F.FF.FF.FF) Channel 1: supply voltage Channel 2: bridge voltage

Distributed Clocks

In DC mode (Distributed Clocks) the process data x1A03 *Timestamp* must be activated.

The screenshot shows the TwinCAT configuration interface for DC mode. The 'Process Data' tab is selected, displaying the 'PDO List' and 'PDO Assignment' sections. In the 'PDO List', the entry for '0x1A03 RMB Timestamp' is highlighted with a red box. In the 'PDO Assignment' section, the checkbox for '0x1A03' is checked and highlighted with a red box. Below these sections, a table lists process data variables, with 'Timestamp' highlighted in red.

Index	Size	Name	Flags	SM	SU
0x1A00	2.0	RMB Status	F	3	0
0x1A01	4.0	RMB Value (INT32)	F	3	0
0x1A02	4.0	RMB Value (Real)	F		0
0x1A03	8.0	RMB Timestamp	F	3	0
0x1A04	6.0	AI Standard Channel 1	F		0
0x1A05	4.0	AI Compact Channel 1	F		0
0x1A06	6.0	AI Standard Channel 2	F		0

Index	Size	Offs	Name	Type	Default (hex)
---	0.1	0.0	---	---	---
0x6000:02	0.1	0.1	Status_Overrange	BIT	---
---	0.1	0.2	---	---	---
0x6000:04	0.1	0.3	Status_Data invalid	BIT	---

Name	Online	Type	Size	>Address	In/Out	User ID	Linked to
Status	0x0000 (0)	Status_9B003EE1	2.0	71.0	Input	0	
Value	0	DINT	4.0	73.0	Input	0	
Timestamp	0x54809E6595DDF4F...	ULINT	8.0	77.0	Input	0	
WcState	0	BIT	0.1	1522.3	Input	0	
InputToggle	0	BIT	0.1	1524.3	Input	0	
State	0x0008 (8)	UINT	2.0	1548.0	Input	0	
AdsAddr	10.1.160.5.2.1:1001	AMSADDR	8.0	1550.0	Input	0	
Ctrl	0	Ctrl_BCBED05B	2.0	71.0	Output	0	

Also, the variables *DcOutputShift* and *DcInputShift* are displayed in the process data in DC mode. Upon activation of the configuration these are calculated once in the unit [ns] on the basis of the set EtherCAT cycle time (observe assigned task!) and DC shift times from the EtherCAT master settings. In the *InputBased* operating mode, *DcInputShift* indicates by how many nanoseconds [ns] before or after the global Sync the box determines your process data. For further information on this, see the [EtherCAT system description](#).

Since the EPP3356-0022 is not DC-triggered but determines the timestamp itself, these values have no meaning in the EPP3356-0022.

Sync Manager (SM)

PDO Assignment

Inputs: SM3, PDO Assignment 0x1C13

Index	Index of excluded PDOs	Size (byte.bit)	Name	PDO content Index - Name
0x1A00 (default)	-	2.0	RMB Status (Resistor Measurement Bridge)	0x6000:02 [▶ 57] - Overrange 0x6000:04 [▶ 57] - Data invalid 0x6000:07 [▶ 57] - Error 0x6000:08 [▶ 57] - Calibration in progress 0x6000:09 [▶ 57] - Steady State 0x1C32:20 [▶ 54] - Sync Error 0x1800:09 [▶ 54] - TxPDO Toggle
0x1A01 (default)	0x1A02 0x1A04 0x1A05 0x1A06 0x1A07	4.0	RMB Value (INT 32)	0x6000:11 [▶ 57] - Value
0x1A02	0x1A01 0x1A04 0x1A05 0x1A06 0x1A07	4.0	RMB Value (Real)	0x6000:12 [▶ 57] - Value
0x1A03	0x1A04 0x1A05 0x1A06 0x1A07	8.0	RMB Timestamp	0x6000:13 [▶ 57] - Value
0x1A04	0x1A00 0x1A01 0x1A02 0x1A03 0x1A05	6.0	AI Standard Channel 1 (Analog Input)	0x6010:01 [▶ 57] - Underrange 0x6010:02 [▶ 57] - Overrange 0x6010:07 [▶ 57] - Error 0x6010:10 [▶ 57] - TxPDO Toggle 0x6010:11 [▶ 57] - Value
0x1A05	0x1A00 0x1A01 0x1A02 0x1A03 0x1A04	4.0	AI Standard Channel 1 (Analog Input)	0x6010:11 [▶ 57] - Value
0x1A06	0x1A00 0x1A01 0x1A02 0x1A03 0x1A07	6.0	AI Standard Channel 2 (Analog Input)	0x6020:01 [▶ 57] - Underrange 0x6020:02 [▶ 57] - Overrange 0x6020:07 [▶ 57] - Error 0x6020:10 [▶ 57] - TxPDO Toggle 0x6020:11 [▶ 57] - Value
0x1A07	0x1A00 0x1A01 0x1A02 0x1A03 0x1A06	4.0	AI Standard Channel 2 (Analog Input)	0x6020:11 [▶ 57] - Value

Outputs: SM2, PDO-Zuordnung 0x1C12

Index	Index aus-geschlossener PDOs	Größe (Byte.Bit)	Name	PDO Inhalt
0x1600 (default)	-	2.0	RMB Control (Resistor Measurement bridge)	0x7000:01 [▶ 57] - Start calibration 0x7000:02 [▶ 57] - Disable calibration 0x7000:03 [▶ 57] - Input freeze 0x7000:04 [▶ 57] - Sample Mode 0x7000:05 [▶ 57] - Tara

6.8 Sample program

NOTICE

**See documentation on EP3356-0022**

The documentation on EP3356-0022 contains a sample program. The sample program is transferable to the EPP3356-0022.

[Documentation on EP3356-0022](#)

6.9 Restore the delivery state

You can restore the delivery state of the backup objects as follows:

1. Ensure that TwinCAT is running in Config mode.
2. In CoE object 1011:0 "Restore default parameters" select parameter 1011:01 "Subindex 001".

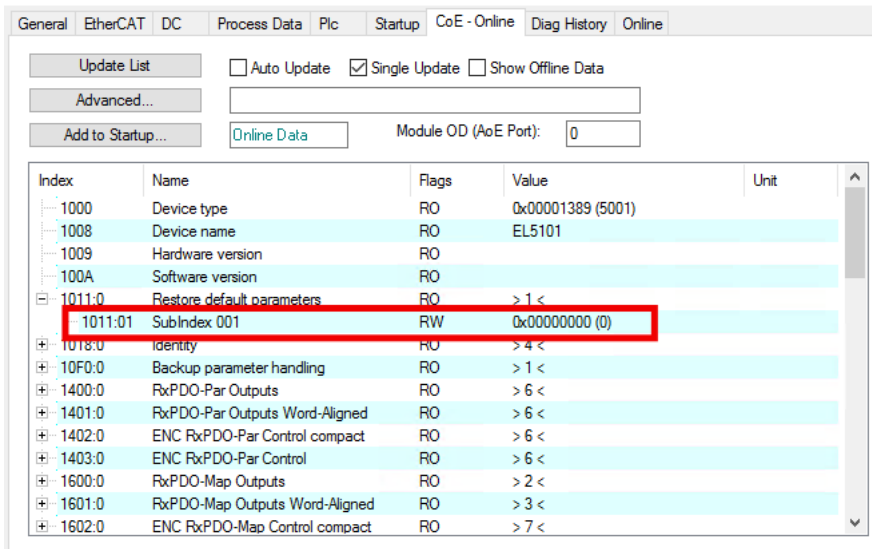

3. Double-click on "Subindex 001".
⇒ The "Set Value Dialog" dialog box opens.
4. Enter the value 1684107116 in the "Dec" field.
Alternatively: enter the value 0x64616F6C in the "Hex" field.

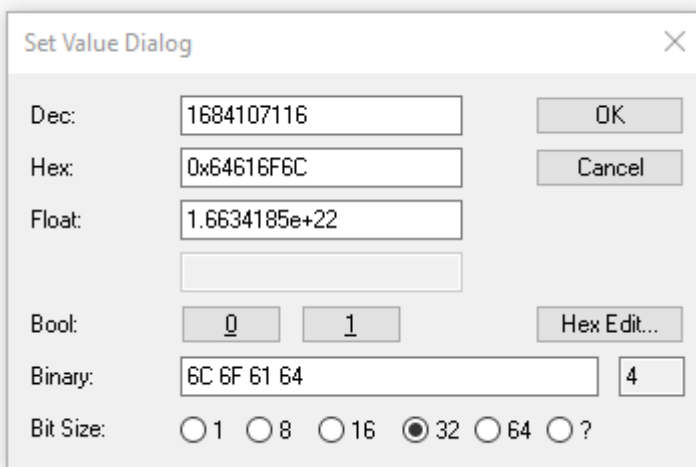

5. Confirm with "OK".
⇒ All backup objects are reset to the delivery state.

i Alternative restore value

With some older modules the backup objects can be changed with an alternative restore value:

Decimal value: 1819238756

Hexadecimal value: 0x6C6F6164

An incorrect entry for the restore value has no effect.

7 Decommissioning

⚠ WARNING**Risk of electric shock!**

Bring the bus system into a safe, de-energized state before starting disassembly of the devices!

8 CoE parameters

Parameterization



You can parameterize the box via the "CoE - Online" tab in TwinCAT.

EtherCAT XML Device Description



The presentation matches that of the EtherCAT XML Device Description.

Recommendation: download the latest XML file from <https://www.beckhoff.com/> and install it according to the installation instructions.

Index 1011 Restore default parameters

Index (hex)	Name	Meaning	Data type	Flags	Default
1011:0	Restore default parameters	Restore the default settings in the EtherCAT slave	UINT8	RO	0x01 (1 _{dec})
1011:01	SubIndex 001	If this object is set to " 0x64616F6C " ("Set Value Dialog") all terminal/box-specific objects are reset to their delivery state.	UINT32	RW	0x00000000 (0 _{dec})

Index 8000 RMB Settings

Index (hex)	Name	Meaning	Data type	Flags	Default
8000:0	RMB Settings	Max. subindex	UINT8	RO	0x32 (50 _{dec})
8000:01	Mode0 enable filter	0: No filters active. The box operates cycle-synchronously 1: The filter settings selected in subindex 0x8000:11 or 0x8000:12 are active.	BOOLEAN	RW	0x01 (1 _{dec})
8000:02	Mode1 enable filter		BOOLEAN	RW	0x01 (1 _{dec})
8000:03	Mode0 enable averager	Activate hardware mean value filter	BOOLEAN	RW	0x01 (1 _{dec})
8000:04	Mode1 enable averager		BOOLEAN	RW	0x01 (1 _{dec})
8000:05	Symmetric reference potential	Activate <i>symmetric measurement</i> [► 13]	BOOLEAN	RW	0x01 (1 _{dec})
8000:11	Mode0 filter settings	0: FIR 50 Hz 1: FIR 60 Hz 2: IIR 1 3: IIR 2 4: IIR 3 5: IIR 4 6: IIR 5 7: IIR 6 8: IIR 7 9: IIR 8 10: Dynamic IIR 11: PDO Filter frequency see <i>Filter</i> [► 13]	UINT16	RW	0x0000 (0 _{dec})
8000:12	Mode1 filter settings		UINT16	RW	0x0000 (0 _{dec})
8000:13	Dynamic filter change time	Sampling rate for dynamic filter switching. Scaling in 0.01 ms (100 = 1 s) (only if the filters are active and "dynamic IIR" is selected as <i>filter</i> [► 13])	UINT16	RW	0x000A (10 _{dec})
8000:14	Dynamic filter delta	Limit value for dynamic filter switching. (only if the filters are active and "dynamic IIR" is selected as <i>filter</i> [► 13])	REAL32	RW	0x41A00000 (1101004800 _{dec}) = 20.0
8000:21	Gain	Scaling factor	REAL32	RW	0x3F800000 (1065353216 _{dec}) = 1.0
8000:22	Tara	Process data value offset	REAL32	RW	0x00000000 (0 _{dec}) = 0.0
8000:23	Rated output	Nominal characteristic value of the sensor element in mV/V	REAL32	RW	0x40000000 (1073741824 _{dec}) = 2.0

Index (hex)	Name	Meaning	Data type	Flags	Default
8000:24	Nominal load	Nominal load of the force transducer/load cell/etc. (e.g. in kg or N or ..)	REAL32	RW	0x40A00000 (1084227584 _{dec}) = 5.0
8000:25	Zero balance	Zero point offset in mV/V	REAL32	RW	0x00000000 (0 _{dec}) = 0.0
8000:26	Gravity of earth	Current acceleration of gravity (default 9.806650)	REAL32	RW	0x411CE80A (1092413450 _{dec}) = 9.806650
8000:27	Scale factor	This factor can be used to re-scale the process data. In order to change the display from kg to g, for example, the factor 1000 can be entered here.	REAL32	RW	0x447A0000 (1148846080 _{dec}) = 1000.0
8000:28	Reference load	Reference weight for manual calibration	REAL32	RW	0x40A00000 (1084227584 _{dec}) = 5.0
8000:29	Steady state window	Time constant for the "Steady state" bit (used for <u>idle recognition</u> ► 331)	UINT16	RW	0x03E8 (1000 _{dec})
8000:2A	Steady state tolerance	Tolerance window for the "Steady state" bit	UINT32	RW	0x00000005 (5 _{dec})
8000:31	Calibration interval	Calibration interval for automatic calibration of the terminal/box. The unit is 100 ms. The smallest possible value is 5 (500 ms). A value of 0 deactivates automatic self-calibration. This is also possible via the process data bit "Disable calibration".	UINT16	RW	0x0708 (1800 _{dec})
8000:32	Test interval	This register contains the test interval for the cyclic self-test of the terminal/box. This interval is always a multiple (default: 10 _{dec}) of the calibration interval (0x8000:31). The test interval when the equipment leaves the factory is therefore 10 x 180 s = 1800 s. The process data bit "Disable calibration" can be used to deactivate the self-test.	UINT16	RW	0x000A (10 _{dec})

Index 8010, 8020 AI Settings

Index (hex)	Name	Meaning	Data type	Flags	Default
80n0:0	AI Settings	Max. subindex	UINT8	RO	0x18 (24 _{dec})
80n0:01	Enable user scale	User scale is enabled, if bit is set	BOOLEAN	RW	0x00 (0 _{dec})
80n0:06	Enable filter	Activates filter	BOOLEAN	RW	0x01 (1 _{dec})
80n0:0A	Enable user calibration	User calibration is enabled, if bit is set	BOOLEAN	RW	0x00 (0 _{dec})
80n0:0B	Enable vendor calibration	Vendor calibration is enabled, if bit is set	BOOLEAN	RW	0x01 (1 _{dec})
80n0:11	User scale offset	User scale offset	INT32	RW	0x00000000 (0 _{dec})
80n0:12	User scale gain	User scale gain The gain is represented in fixed-point format, with the factor 2 ⁻¹⁶ . A value of 1 for the gain factor therefore corresponds to 65535 _{dec} (0x00010000 _{hex}) and is limited to 0x7FFFF.	INT32	RW	0x00010000 (65536 _{dec})
80n0:15	Filter settings	This object defines the digital filter settings, if it is activated with index 0x80n0:06 [► 56] . The possible settings are numbered consecutively 0: 50 Hz FIR 1: 60 Hz FIR 2: IIR 1 3: IIR 2 4: IIR 3 5: IIR 4 6: IIR 5 7: IIR 6 8: IIR 7 9: IIR 8	UINT16	RW	0x0000 (0 _{dec})
80n0:17	User calibration offset	User calibration offset	INT32	RW	0x00000000 (0 _{dec})
80n0:18	User calibration gain	User calibration gain	INT16	RW	0x4000 (16384 _{dec})

Command object, Index FB00 RMB Command

Index (hex)	Name	Meaning	Data type	Flags	Default
FB00:0	RMB Command	Max. subindex	UINT8	RO	0x03 (3 _{dec})
FB00:01	Request	Via the request object, commands can be sent to the terminal/box Command: - 0x0101: Zero adjustment - 0x0102: Calibration - 0x0001 Tara setting - 0x0002 Tara setting (Data are saved into the EEPROM) see commands [► 13]	OCTET-STRING[2]	RW	{0}
FB00:02	Status	State of the current executed command 0: Command executed without errors 255: Execution of command	UINT8	RO	0x00 (0 _{dec})
FB00:03	Response	Optional return value of the command	OCTET-STRING[4]	RO	{0}

Input data, Index 6000 RMB Inputs

Index (hex)	Name	Meaning	Data type	Flags	Default
6000:0	RMB Inputs	Max. subindex	UINT8	RO	0x13 (19 _{dec})
6000:02	Overrange	The measuring value has reached its terminal/box value	BOOLEAN	RO	0x00 (0 _{dec})
6000:04	Data invalid	The indicated process data are not valid, e.g. during calibration	BOOLEAN	RO	0x00 (0 _{dec})
6000:07	Error	An error has occurred	BOOLEAN	RO	0x00 (0 _{dec})
6000:08	Calibration in progress	Calibration in progress. The process data indicate the last valid measuring value	BOOLEAN	RO	0x00 (0 _{dec})
6000:09	Steady state		BOOLEAN	RO	0x00 (0 _{dec})
6000:0E	Sync error	TRUE: In the last cycle the synchronization was not correct (only in DC-Mode)	BOOLEAN	RO	0x00 (0 _{dec})
6000:10	TxPDO Toggle	The TxPDO Toggle is toggled by the slave, if the data of the corresponding PDO was updated.	BOOLEAN	RO	0x00 (0 _{dec})
6000:11	Value	Measuring value as 32 Bit SIGNED INTEGER	INT32	RO	0x61746144 (1635017028 _{dec})
6000:12	Value (Real)	Measuring value as REAL	REAL32	RO	0x00000000 (0 _{dec})
6000:13	Timestamp	Timestamp of current measuring value (only in DC-Mode)	UINT64	RO	

Input data Index 6010, 6020 AI Inputs

Index (hex)	Name	Meaning	Data type	Flags	Default
60n0:0	AI Inputs	Max. subindex	UINT8	RO	0x11 (17 _{dec})
60n0:01	Underrange	Value falls below the measuring range	BOOLEAN	RO	0x00 (0 _{dec})
60n0:02	Overrange	Measurement range is exceeded.	BOOLEAN	RO	0x00 (0 _{dec})
60n0:07	Error	An error has occurred, e.g.: - Over- / underrange U_{dif} - Over- / underrange U_{ref} - the external U_{ref} is too low (between -1 V and +1 V) - Data invalid	BOOLEAN	RO	0x00 (0 _{dec})
60n0:10	TxPDO Toggle	The TxPDO Toggle is toggled by the slave, if the data of the corresponding PDO was updated.	BOOLEAN	RO	0x00 (0 _{dec})
60n0:11	Value	32 Bit measuring value	INT32	RO	0x00000000 (0 _{dec})

Output data, Index 7000 RMB Outputs

Index (hex)	Name	Meaning	Data type	Flags	Default
7000:0	RMB Outputs	Max. subindex	UINT8	RO	0x05 (5 _{dec})
7000:01	Start calibration	The calibration can be started manually with a rising edge. Therefore, an automatic start of the calibration at an inappropriate point of time can be prevented.	BOOLEAN	RO	0x00 (0 _{dec})
7000:02	Disable calibration	0: The automatic calibration is active 1: The automatic calibration is inactive	BOOLEAN	RO	0x00 (0 _{dec})
7000:03	Input freeze	The process data and the digital filter will be frozen	BOOLEAN	RO	0x00 (0 _{dec})
7000:04	Sample mode	Selection of the sampling mode: 0: 10.5 kHz High precision 1: 105 kHz Low latency	BOOLEAN	RO	0x00 (0 _{dec})
7000:05	Tara	The process data can be set to zero with a rising edge. The tara value is not stored in the EEPROM and is lost after a reset of the terminal/box	BOOLEAN	RO	0x00 (0 _{dec})
7000:11	Filter frequency	Filter frequency of the variable PDO filter in 0.1 Hz, see filter [► 13] Wertebereich: value range: 1 ... 2000 (equates to 0,1 ... 200 Hz) From a value 0 or >2000, the filter behaves like a 50 Hz FIR filter	UINT16	RO	0x00 (0 _{dec})

Information-/diagnostic data, Index 801E, 802E AI Internal data

Index (hex)	Name	Meaning	Data type	Flags	Default
801E:0	AI Internal data	Max. subindex	UINT8	RO	0x01 (1 _{dec})
801E:01	ADC raw value 1	ADC raw value	INT32	RO	0x00000000 (0 _{dec})

Index 9000 RMB Info data

Index (hex)	Name	Meaning	Data type	Flags	Default
9000:0	RMB Info data	Max. subindex	UINT8	RO	0x11 (17 _{dec})
9000:11	mV/V	Current mV/V value	REAL32	RO	0x00000000 (0 _{dec})

Index A000 RMB Diag data

Index (hex)	Name	Meaning	Data type	Flags	Default
A000:0	RMB Diag data	Max. subindex	UINT8	RO	0x18 (24 _{dec})
A000:11	No internal referencnce supply	No internal reference voltage at ADC input (U _{Ref} channel)	BOOLEAN	RO	0x00 (0 _{dec})
A000:12	No internal referencnce bridge	No internal reference voltage at ADC input (U _{Dif} channel)	BOOLEAN	RO	0x00 (0 _{dec})
A000:13	No external reference supply	The external reference voltage is below ±1 V	BOOLEAN	RO	0x00 (0 _{dec})
A000:15	Overrange bridge	Overranged measuring value in the bridge section	BOOLEAN	RO	0x00 (0 _{dec})
A000:16	Underrange bridge	Underranged measuring value in the bridge section	BOOLEAN	RO	0x00 (0 _{dec})
A000:17	Overrange supply	Overranged measuring value of the reference voltage	BOOLEAN	RO	0x00 (0 _{dec})
A000:18	Underrange supply	Underranged measuring value of the reference voltage	BOOLEAN	RO	0x00 (0 _{dec})

Vendor configuration data, Index 801F, 802F AI Vendor data

Index (hex)	Name	Meaning	Data type	Flags	Default
801F:0	AI Vendor data	Max. subindex	UINT8	RO	0x02 (2 _{dec})
801F:01	Calibration offset	Offset (vendor calibration))	INT32	RW	0x01E10000 (31522816 _{dec})
801F:02	Calibration gain	Gain (vendor calibration))	INT16	RW	0x4000 (16384 _{dec})

Standard objects, Index 1000 Device type

Index (hex)	Name	Meaning	Data type	Flags	Default
1000:0	Device type	Device type of the EtherCAT slave: The low word contains the CoE profile used (5001). The high word contains the module profile according to the modular device profile.	UINT32	RO	0x01681389 (23597961 _{dec})

Index 1008 Device name

Index (hex)	Name	Meaning	Data type	Flags	Default
1008:0	Device name	Device name of the EtherCAT slave	STRING	RO	EPP3356-0022

Index 1009 Hardware version

Index (hex)	Name	Meaning	Data type	Flags	Default
1009:0	Hardware version	Hardware version of the EtherCAT slave	STRING	RO	00

Index 100A Software version

Index (hex)	Name	Meaning	Data type	Flags	Default
100A:0	Software version	Firmware version of the EtherCAT slave	STRING	RO	01

Index 1018 Identity

Index (hex)	Name	Meaning	Data type	Flags	Default
1018:0	Identity	Information for identifying the slave	UINT8	RO	0x04 (4 _{dec})
1018:01	Vendor ID	Vendor ID of the EtherCAT slave	UINT32	RO	0x00000002 (2 _{dec})
1018:02	Product code	Product code of the EtherCAT slave	UINT32	RO	0x647697C9 (1685493705 _{dec})
1018:03	Revision	Revision number of the EtherCAT slave; the low word (bit 0-15) indicates the special terminal/box number, the high word (bit 16-31) refers to the device description	UINT32	RO	0x00100000 (1048576 _{dec})
1018:04	Serial number	Serial number of the EtherCAT slave; the low byte (bit 0-7) of the low word contains the year of production, the high byte (bit 8-15) of the low word contains the week of production, the high word (bit 16-31) is 0	UINT32	RO	0x00000000 (0 _{dec})

Index 10F0 Backup parameter handling

Index (hex)	Name	Meaning	Data type	Flags	Default
10F0:0	Backup parameter handling	Information for standardized loading and saving of backup entries	UINT8	RO	0x01 (1 _{dec})
10F0:01	Checksum	Checksum across all backup entries of the EtherCAT slave	UINT32	RO	0x00000000 (0 _{dec})

Index 1600 RMB RxPDO-Map Control

Index (hex)	Name	Meaning	Data type	Flags	Default
1600:0	RMB RxPDO-Map Control	PDO Mapping RxPDO-Map control	UINT8	RO	0x07 (7 _{dec})
1600:01	Subindex 001	1. PDO Mapping entry (object 0x7000 (RMB outputs), entry 0x01 (Start calibration))	OCTET-STRING[10]	RO	0x7000:01, 1
1600:02	Subindex 002	2. PDO Mapping entry (object 0x7000 (RMB outputs), entry 0x02 (Disable calibration))	OCTET-STRING[10]	RO	0x7000:02, 1
1600:03	Subindex 003	3. PDO Mapping entry (object 0x7000 (RMB outputs), entry 0x03 (Input freeze))	OCTET-STRING[10]	RO	0x7000:03, 1
1600:04	Subindex 004	4. PDO Mapping entry (1 bits align)	OCTET-STRING[10]	RO	0x0000:00, 1
1600:05	Subindex 005	5. PDO Mapping entry (object 0x7000 (RMB outputs), entry 0x05 (Tara))	OCTET-STRING[10]	RO	0x7000:05, 1
1600:06	Subindex 006	6. PDO Mapping entry (3 bits align)	OCTET-STRING[10]	RO	0x0000:00, 3
1600:07	Subindex 007	7. PDO Mapping entry (8 bits align)	OCTET-STRING[10]	RO	0x0000:00, 8

Index 1601 RMB RxPDO-Map-Filter frequency

Index (hex)	Name	Meaning	Data type	Flags	Default
1601:0	RMB RxPDO-Map Filter frequency	PDO Mapping RxPDO-Map Filter frequency	UINT8	RO	0x01 (1 _{dec})
1601:01	Subindex 001	1. PDO Mapping entry (object 0x7000 (RMB outputs), entry 0x11 (Start calibration))	OCTET-STRING[10]	RO	0x7000:11, 16

Index 1800 RMB TxPDO-Par Status

Index (hex)	Name	Meaning	Data type	Flags	Default
1800:0	RMB TxPDO-Par Status	PDO Parameter TxPDO 1	UINT8	RO	0x06 (6 _{dec})
1800:06	Exclude TxPDOs	This entry contains the TxPDOs (Index of the TxPDO Mapping objects) which shall not be transmitted with TxPDO 1	OCTET-STRING[10]	RO	04 1A 05 1A 06 1A 07 1A 00 00

Index 1801 RMB TxPDO-Par Value (INT 32)

Index (hex)	Name	Meaning	Data type	Flags	Default
1801:0	RMB TxPDO-Par Value (INT32)	PDO Parameter TxPDO 2	UINT8	RO	0x06 (6 _{dec})
1801:06	Exclude TxPDOs	This entry contains the TxPDOs (Index of the TxPDO Mapping objects) which shall not be transmitted with TxPDO 2	OCTET-STRING[10]	RO	02 1A 04 1A 05 1A 06 1A 07 1A

Index 1802 RMB TxPDO-Par Value (Real)

Index (hex)	Name	Meaning	Data type	Flags	Default
1802:0	RMB TxPDO-Par Value (Real)	PDO Parameter TxPDO 3	UINT8	RO	0x06 (6 _{dec})
1802:06	Exclude TxPDOs	This entry contains the TxPDOs (Index of the TxPDO Mapping objects) which shall not be transmitted with TxPDO 3	OCTET-STRING[10]	RO	01 1A 04 1A 05 1A 06 1A 07 1A

Index 1803 RMB TxPDO-Par Timestamp

Index (hex)	Name	Meaning	Data type	Flags	Default
1803:0	RMB TxPDO-Par Timestamp	PDO Parameter TxPDO 4	UINT8	RO	0x06 (6 _{dec})
1803:06	Exclude TxPDOs	This entry contains the TxPDOs (Index of the TxPDO Mapping objects) which shall not be transmitted with TxPDO 4	OCTET-STRING[10]	RO	04 1A 05 1A 06 1A 07 1A 00 00

Index 1804 AI TxPDO-Par Standard Ch. 1

Index (hex)	Name	Meaning	Data type	Flags	Default
1804:0	AI TxPDO-Par Standard Ch.1	PDO Parameter TxPDO 5	UINT8	RO	0x06 (6 _{dec})
1804:06	Exclude TxPDOs	This entry contains the TxPDOs (Index of the TxPDO Mapping objects) which shall not be transmitted with TxPDO 5	OCTET-STRING[10]	RO	05 1A 00 1A 01 1A 02 1A 03 1A

Index 1805 AI TxPDO-Par Compact Ch.1

Index (hex)	Name	Meaning	Data type	Flags	Default
1805:0	AI TxPDO-Par Compact Ch.1	PDO Parameter TxPDO 6	UINT8	RO	0x06 (6 _{dec})
1805:06	Exclude TxPDOs	This entry contains the TxPDOs (Index of the TxPDO Mapping objects) which shall not be transmitted with TxPDO 6	OCTET-STRING[10]	RO	04 1A 00 1A 01 1A 02 1A 03 1A

Index 1806 AI TxPDO-Par Standard Ch.2

Index (hex)	Name	Meaning	Data type	Flags	Default
1806:0	AI TxPDO-Par Standard Ch.2	PDO Parameter TxPDO 7	UINT8	RO	0x06 (6 _{dec})
1806:06	Exclude TxPDOs	This entry contains the TxPDOs (Index of the TxPDO Mapping objects) which shall not be transmitted with TxPDO 7	OCTET-STRING[10]	RO	07 1A 00 1A 01 1A 02 1A 03 1A

Index 1807 AI TxPDO-Par Compact Ch.2

Index (hex)	Name	Meaning	Data type	Flags	Default
1807:0	AI TxPDO-Par Compact Ch.2	PDO Parameter TxPDO 8	UINT8	RO	0x06 (6 _{dec})
1807:06	Exclude TxPDOs	This entry contains the TxPDOs (Index of the TxPDO Mapping objects) which shall not be transmitted with TxPDO 8	OCTET-STRING[10]	RO	06 1A 00 1A 01 1A 02 1A 03 1A

Index 1A00 RMB TxPDO-Map Status

Index (hex)	Name	Meaning	Data type	Flags	Default
1A00:0	RMB TxPDO-Map Status	PDO Mapping RxPDO-Map Status	UINT8	RO	0x0C (12 _{dec})
1A00:01	Subindex 001	1. PDO Mapping entry (1 bits align)	OCTET-STRING[10]	RO	0x0000:00, 1
1A00:02	Subindex 002	2. PDO Mapping entry (object 0x6000 (RMB inputs), entry 0x02 (Overrange))	OCTET-STRING[10]	RO	0x6000:02, 1
1A00:03	Subindex 003	3. PDO Mapping entry (1 bits align)	OCTET-STRING[10]	RO	0x0000:00, 1
1A00:04	Subindex 004	4. PDO Mapping entry (object 0x6000 (RMB inputs), entry 0x04 (Data invalid))	OCTET-STRING[10]	RO	0x6000:04, 1
1A00:05	Subindex 005	5. PDO Mapping entry (2 bits align)	OCTET-STRING[10]	RO	0x0000:00, 2
1A00:06	Subindex 006	6. PDO Mapping entry (object 0x6000 (RMB inputs), entry 0x07 (Error))	OCTET-STRING[10]	RO	0x6000:07, 1
1A00:07	Subindex 007	7. PDO Mapping entry (object 0x6000 (RMB inputs), entry 0x08 (Calibration in progress))	OCTET-STRING[10]	RO	0x6000:08, 1
1A00:08	Subindex 008	8. PDO Mapping entry (object 0x6000 (RMB inputs), entry 0x09 (Steady state))	OCTET-STRING[10]	RO	0x6000:09, 1
1A00:09	Subindex 009	9. PDO Mapping entry (4 bits align)	OCTET-STRING[10]	RO	0x0000:00, 4
1A00:0A	Subindex 010	10. PDO Mapping entry (object 0x6000 (RMB inputs), entry 0x0E (Sync error))	OCTET-STRING[10]	RO	0x6000:0E, 1
1A00:0B	Subindex 011	11. PDO Mapping entry (1 bits align)	OCTET-STRING[10]	RO	0x0000:00, 1
1A00:0C	Subindex 012	12. PDO Mapping entry (object 0x6000 (RMB inputs), entry 0x10 (TxPDO Toggle))	OCTET-STRING[10]	RO	0x6000:10, 1

Index 1A01 RMB TxPDO-Map Value (INT32)

Index (hex)	Name	Meaning	Data type	Flags	Default
1A01:0	RMB TxPDO-Map Value (INT32)	PDO Mapping Value (INT32)	UINT8	RW	0x01 (1 _{dec})
1A01:01	SubIndex 001	1. PDO Mapping entry (object 0x6000 (RMB inputs), entry 0x11 (Value))	UINT32	RW	0x6000:11, 32

Index 1A02 RMB TxPDO-Map Value (Real)

Index (hex)	Name	Meaning	Data type	Flags	Default
1A02:0	RMB TxPDO-Map Value (real)	PDO Mapping Value (real)	UINT8	RW	0x01 (1 _{dec})
1A02:01	SubIndex 001	1. PDO Mapping entry (object 0x6000 (RMB inputs), entry 0x12 (Value (real)))	UINT32	RW	0x6000:12, 32

Index 1A03 RMB TxPDO-Map Timestamp

Index (hex)	Name	Meaning	Data type	Flags	Default
1A03:0	RMB TxPDO-Map Timestamp	PDO Mapping Value Timestamp	UINT8	RW	0x01 (1 _{dec})
1A03:01	SubIndex 001	1. PDO Mapping entry (object 0x0000, entry 0x00)	UINT64	RW	0x0000:00, 64

Index 1A04 AI TxPDO-Map Standard Ch.1

Index (hex)	Name	Meaning	Data type	Flags	Default
1A04:0	AI supply TxPDO-Map Standard Ch. 1	PDO Mapping TxPDO Standard Ch. 1	UINT8	RW	0x07 (7 _{dec})
1A04:01	SubIndex 001	1. PDO Mapping entry (object 0x6010 (AI supply Inputs), entry 0x01 (Underrange))	UINT32	RW	0x6010:01, 1
1A04:02	SubIndex 002	2. PDO Mapping entry (object 0x6010 (AI supply Inputs), entry 0x02 (Overrange))	UINT32	RW	0x6010:02, 1
1A04:03	SubIndex 003	3. PDO Mapping entry (4 bits align)	UINT32	RW	0x0000:00, 4
1A04:04	SubIndex 004	4. PDO Mapping entry (object 0x6010 (AI supply Inputs), entry 0x04 (Error))	UINT32	RW	0x6010:07, 1
1A04:05	SubIndex 005	5. PDO Mapping entry (8 bits align)	UINT32	RW	0x0000:00, 8
1A04:06	SubIndex 006	6. PDO Mapping entry (object 0x6010, entry 0x10 (TxPDO Toggle))	UINT32	RW	0x6010:10, 1
1A04:07	SubIndex 007	7. PDO Mapping entry (object 0x6010, entry 0x11 (Value))	UINT32	RW	0x6010:11, 32

Index 1A05 AI TxPDO-Map Compact Ch.1

Index (hex)	Name	Meaning	Data type	Flags	Default
1A05:0	AI supply TxPDO-Map Compact Ch. 1	PDO Mapping TxPDO Compact Ch. 1	UINT8	RW	0x01 (1 _{dec})
1A05:01	SubIndex 001	1. PDO Mapping entry (object 0x6010, entry 0x11 (Value))	UINT32	RW	0x6010:11, 32

Index 1A06 AI TxPDO-Map Standard Ch.2

Index (hex)	Name	Meaning	Data type	Flags	Default
1A06:0	AI supply TxPDO-Map Standard Ch. 2	PDO Mapping TxPDO Standard Ch. 2	UINT8	RW	0x07 (7 _{dec})
1A06:01	SubIndex 001	1. PDO Mapping entry (object 0x6020 (AI supply Inputs), entry 0x01 (Underrange))	UINT32	RW	0x6020:01, 1
1A06:02	SubIndex 002	2. PDO Mapping entry (object 0x6020 (AI supply Inputs), entry 0x02 (Overrange))	UINT32	RW	0x6020:02, 1
1A06:03	SubIndex 003	3. PDO Mapping entry (4 bits align)	UINT32	RW	0x0000:00, 4
1A06:04	SubIndex 004	4. PDO Mapping entry (object 0x6020 (AI supply Inputs), entry 0x04 (Error))	UINT32	RW	0x6020:07, 1
1A06:05	SubIndex 005	5. PDO Mapping entry (8 bits align)	UINT32	RW	0x0000:00, 8
1A06:06	SubIndex 006	6. PDO Mapping entry (object 0x6020, entry 0x10 (TxPDO Toggle))	UINT32	RW	0x6020:10, 1
1A06:07	SubIndex 007	7. PDO Mapping entry (object 0x6020, entry 0x11 (Value))	UINT32	RW	0x6020:11, 32

Index 1A07 AI TxPDO-Map Compact Ch.2

Index (hex)	Name	Meaning	Data type	Flags	Default
1A07:0	AI supply TxPDO-Map Compact Ch. 2	PDO Mapping TxPDO Compact Ch. 2	UINT8	RW	0x01 (1 _{dec})
1A07:01	SubIndex 001	1. PDO Mapping entry (object 0x6020, entry 0x11 (Value))	UINT32	RW	0x6020:11, 32

Index 1C00 Sync manager type

Index (hex)	Name	Meaning	Data type	Flags	Default
1C00:0	Sync manager type	Usage of the Sync Manager channels	UINT8	RO	0x04 (4 _{dec})
1C00:01	SubIndex 001	Sync-Manager Type Channel 1: Mailbox Write	UINT8	RO	0x01 (1 _{dec})
1C00:02	SubIndex 002	Sync-Manager Type Channel 2: Mailbox Read	UINT8	RO	0x02 (2 _{dec})
1C00:03	SubIndex 003	Sync-Manager Type Channel 3: Process Data Write (Outputs)	UINT8	RO	0x03 (3 _{dec})
1C00:04	SubIndex 004	Sync-Manager Type Channel 4: Process Data Read (Inputs)	UINT8	RO	0x04 (4 _{dec})

Index 1C12 RxPDO assign

Index (hex)	Name	Meaning	Data type	Flags	Default
1C12:0	RxPDO assign	PDO Assign Inputs	UINT8	RW	0x01 (1 _{dec})
1C12:01	Subindex 001	1. assigned TxPDO (contains the index of the corresponding TxPDO Mapping object)	UINT16	RW	0x1600 (5632 _{dec})
1C12:02	Subindex 002	2. assigned TxPDO (contains the index of the corresponding TxPDO Mapping object)	UINT16	RW	-

Index 1C13 TxPDO assign

Index (hex)	Name	Meaning	Data type	Flags	Default
1C13:0	TxPDO assign	PDO Assign Inputs	UINT8	RW	0x01 (1 _{dec})
1C13:01	Subindex 001	1. assigned TxPDO (contains the index of the corresponding TxPDO Mapping object)	UINT16	RW	0x1A00 (6656 _{dec})
1C13:02	Subindex 002	2. assigned TxPDO (contains the index of the corresponding TxPDO Mapping object)	UINT16	RW	0x1A01 (6657 _{dec})
1C13:03	Subindex 003	3. assigned TxPDO (contains the index of the corresponding TxPDO Mapping object)	UINT16	RW	-

Index 1C32 SM output parameter

Index (hex)	Name	Meaning	Data type	Flags	Default
1C32:0	SM output parameter	Synchronization parameter of the outputs	UINT8	RO	0x20 (32 _{dec})
1C32:01	Sync mode	Actual synchronization mode: <ul style="list-style-type: none"> 0: Free Run 1: Synchron with SM 3 Event (no Outputs available) 2: DC - Synchron with SYNC0 Event 3: DC - Synchron with SYNC1 Event 	UINT16	RW	0x0001 (1 _{dec})
1C32:02	Cycle time	Cycle time (in ns): <ul style="list-style-type: none"> Free Run: cycle time of the local timer Synchron with SM 2 Event: Cycle time of the master DC-Mode: SYNC0/SYNC1 Cycle time 	UINT32	RW	0x000C65D4 (812500 _{dec})
1C32:03	Shift time	Time between SYNC0-Event and Input Latch (in ns, only in DC-Mode)	UINT32	RO	0x00000000 (0 _{dec})
1C32:04	Sync modes supported	Supported synchronization modes: <ul style="list-style-type: none"> Bit 0 = 1: Free Run is supported Bit 1 = 1: Synchron with SM 2 Event is supported Bit 2-3 = 01: DC-Mode is supported Bit 4-5 = 01: Input Shift with local event (Outputs available) Bit 4-5 = 10: Output Shift with SYNC1 Event (only DC mode) Bit 14 = 1: dynamic times (could be measured by writing 0x1C32:08) 	UINT16	RO	0xC007 (49159 _{dec})
1C32:05	Minimum cycle time	Minimum cycle time supported (in ns)	UINT32	RO	0x0000C350 (50000 _{dec})
1C32:06	Calc and copy time	Minimum time between SYNC0 and SYNC1 event (in ns, only DC mode)	UINT32	RO	0x00000000 (0 _{dec})
1C32:07	Minimum delay time		UINT32	RO	0x00000000 (0 _{dec})
1C32:08	Command	<ul style="list-style-type: none"> 0: Measurement of the times will be stopped 1: Measurement of the times will be started <p>The Entries 0x1C32:03, 0x1C32:05, 0x1C32:06, 0x1C32:09, 0x1C33:03 [▶ 65], 0x1C33:06 [▶ 65], 0x1C33:09 [▶ 65] will be updated with the maximum measured values.</p> <p>The measured valued well be reset, if measured again</p>	UINT16	RW	0x0000 (0 _{dec})
1C32:09	Maximum Delay time	Time between SYNC1-Event and output latch (in ns, only in DC mode)	UINT32	RO	0x00000000 (0 _{dec})
1C32:0B	SM event missed counter	Number of the missed SM-Events in state OPERATIONAL (only in DC Mode)	UINT16	RO	0x0000 (0 _{dec})
1C32:0C	Cycle exceeded counter	Number of the exceeded cycles in state OPERATIONAL	UINT16	RO	0x0000 (0 _{dec})
1C32:0D	Shift too short counter	Number of the too short distances between SYNC0 and SYNC1 Event (only in DC Mode)	UINT16	RO	0x0000 (0 _{dec})
1C32:20	Sync error	TRUE: In the last cycle the synchronization was not correct (only in DC-Mode)	BOOLEAN	RO	0x00 (0 _{dec})

Index 1C33 SM input parameter

Index (hex)	Name	Meaning	Data type	Flags	Default
1C33:0	SM input parameter	Synchronization parameter of the outputs	UINT8	RO	0x20 (32 _{dec})
1C33:01	Sync mode	Actual synchronization mode: <ul style="list-style-type: none"> • 0: Free Run • 1: Synchron with SM 3 Event (no Outputs available) • 2: DC - Synchron with SYNC0 Event • 3: DC - Synchron with SYNC1 Event • 34: synchronous with SM 2 event (outputs available) 	UINT16	RW	0x0022 (34 _{dec})
1C33:02	Cycle time	same as 0x1C32:02 [► 64]	UINT32	RW	0x000C65D4 (812500 _{dec})
1C33:03	Shift time	Time between SYNC0 event and reading of the inputs (in ns, only DC mode)	UINT32	RO	0x00000000 (0 _{dec})
1C33:04	Sync modes supported	Supported synchronization modes: <ul style="list-style-type: none"> • Bit 0: free run is supported • Bit 1: synchronous with SM 2 event is supported (outputs available) • Bit 1: synchronous with SM 3 event is supported (no outputs available) • Bit 2-3 = 01: DC mode is supported • Bit 4-5 = 01: input shift through local event (outputs available) • Bit 4-5 = 10: input shift with SYNC1 event (no outputs available) • Bit 14 = 1: dynamic times (measurement through writing of 0x1C32:08 [► 64] or 1C33:08) 	UINT16	RO	0xC007 (49159 _{dec})
1C33:05	Minimum cycle time	same as 0x1C32:05 [► 64]	UINT32	RO	0x0000C350 (50000 _{dec})
1C33:06	Calc and copy time	Time between reading of the inputs and availability of the inputs for the master (in ns, only DC mode)	UINT32	RO	0x00000000 (0 _{dec})
1C33:07	Minimum delay time		UINT32	RO	0x00000000 (0 _{dec})
1C33:08	Command	same as 0x1C32:08 [► 64]	UINT16	RW	0x0000 (0 _{dec})
1C33:09	Maximum Delay time	Time between SYNC1 event and reading of the inputs (in ns, only DC mode)	UINT32	RO	0x00000000 (0 _{dec})
1C33:0B	SM event missed counter	same as 0x1C32:11 [► 64]	UINT16	RO	0x0000 (0 _{dec})
1C33:0C	Cycle exceeded counter	same as 0x1C32:12 [► 64]	UINT16	RO	0x0000 (0 _{dec})
1C33:0D	Shift too short counter	same as 0x1C32:13 [► 64]	UINT16	RO	0x0000 (0 _{dec})
1C33:20	Sync error	same as 0x1C32:32 [► 64]	BOOLEAN	RO	0x00 (0 _{dec})

Index F000 Modular device profile

Index (hex)	Name	Meaning	Data type	Flags	Default
F000:0	Modular device profile	General information for the modular device profile	UINT8	RO	0x02 (2 _{dec})
F000:01	Module index distance	Index spacing of the objects of the individual channels	UINT16	RO	0x0010 (16 _{dec})
F000:02	Maximum number of modules	Number of channels	UINT16	RO	0x0001 (1 _{dec})

Index F008 Code word

Index (hex)	Name	Meaning	Data type	Flags	Default
F008:0	Code word	reserved	UINT32	RW	0x00000000 (0 _{dec})

Index F010 Module list

Index (hex)	Name	Meaning	Data type	Flags	Default
F010:0	Module list	Max. subindex	UINT8	RW	0x03 (3 _{dec})
F010:01	SubIndex 001	RMB	UINT32	RW	0x00000172 (370 _{dec})
F010:02	SubIndex 002	AI	UINT32	RW	0x0000012C (300 _{dec})
F010:03	SubIndex 003	AI	UINT32	RW	0x0000012C (300 _{dec})

9 Appendix

9.1 General operating conditions

Protection rating according to IP code

The degrees of protection are defined and divided into different classes in the IEC 60529 standard (EN 60529). Degrees of protection are designated by the letters "IP" and two numerals: **IPxy**

- Numeral x: Dust protection and contact protection
- Numeral y: Protection against water

x	Meaning
0	Not protected
1	Protected against access to dangerous parts with the back of the hand. Protected against solid foreign objects of 50 mm Ø
2	Protected against access to dangerous parts with a finger. Protected against solid foreign objects of 12.5 mm Ø
3	Protected against access to dangerous parts with a tool. Protected against solid foreign objects of 2.5 mm Ø
4	Protected against access to dangerous parts with a wire. Protected against solid foreign objects of 1 mm Ø
5	Protection against access to dangerous parts with a wire. Dust-protected. Ingress of dust is not prevented completely, although the quantity of dust able to penetrate is limited to such an extent that the proper function of the device and safety are not impaired
6	Protection against access to dangerous parts with a wire. Dust-tight. No ingress of dust

y	Meaning
0	Not protected
1	Protection against vertically falling water drops
2	Protection against vertically falling water drops when enclosure tilted up to 15°
3	Protection against spraying water. Water sprayed at an angle of up to 60° on either side of the vertical shall have no harmful effects
4	Protection against splashing water. Water splashed against the enclosure from any direction shall have no harmful effects
5	Protection against water jets.
6	Protection against powerful water jets.
7	Protected against the effects of temporary immersion in water. Ingress of water in quantities causing harmful effects shall not be possible when the enclosure is immersed in water at a depth of 1 m for 30 minutes

Chemical resistance

The resistance refers to the housing of the IP67 modules and the metal parts used. In the table below you will find some typical resistances.

Type	Resistance
Water vapor	unstable at temperatures > 100 °C
Sodium hydroxide solution (ph value > 12)	stable at room temperature unstable > 40 °C
Acetic acid	unstable
Argon (technically pure)	stable

Key

- resistant: Lifetime several months
- non inherently resistant: Lifetime several weeks
- not resistant: Lifetime several hours resp. early decomposition

9.2 Accessories

Mounting

Ordering information	Description	Link
ZS5300-0011	Mounting rail	Website

Cables

A complete overview of pre-assembled cables for fieldbus components can be found [here](#).

Ordering information	Description	Link
ZK2000-6xxx-xxxx	Sensor cable M12, 4-pin	Website
ZK2000-7xxx-0xxx	Sensor cable M12, 4-pin + shield	Website
ZK700x-xxxx-xxxx	EtherCAT P cable M8	Website

Labeling material, protective caps

Ordering information	Description
ZS5000-0012	Protective cap for M8 sockets, P-coded, IP67 (50 pieces)
ZS5000-0020	Protective cap for M12 sockets, IP67 (50 pcs.)
ZS5100-0000	Inscription labels, unprinted, 4 strips of 10
ZS5000-xxxx	Printed inscription labels on enquiry

Tools

Ordering information	Description
ZB8801-0000	Torque wrench for plugs, 0.4...1.0 Nm
ZB8801-0001	Torque cable key for M8 / wrench size 9 for ZB8801-0000
ZB8801-0002	Torque cable key for M12 / wrench size 13 for ZB8801-0000
ZB8801-0003	Torque cable key for M12 field assembly / wrench size 18 for ZB8801-0000

Further accessories

Further accessories can be found in the price list for fieldbus components from Beckhoff and online at <https://www.beckhoff.com>.

9.3 Continuative documentation for I/O components with analog in and outputs

NOTICE



Continuative documentation for I/O components with analog in and outputs

Pay also attention to the continuative documentation

I/O Analog Manual

Notes on I/O components with analog inputs and outputs,

which is available in the Beckhoff [Information-System](#) and for [download](#) on the Beckhoff homepage www.beckhoff.com on the respective product pages!

It explains the basics of sensor technology and contains notes on analog measured values.

9.4 Version identification of EtherCAT devices

9.4.1 General notes on marking

Designation

A Beckhoff EtherCAT device has a 14-digit designation, made up of

- family key
- type
- version
- revision

Example	Family	Type	Version	Revision
EL3314-0000-0016	EL terminal 12 mm, non-pluggable connection level	3314 4-channel thermocouple terminal	0000 basic type	0016
ES3602-0010-0017	ES terminal 12 mm, pluggable connection level	3602 2-channel voltage measurement	0010 high-precision version	0017
CU2008-0000-0000	CU device	2008 8-port fast ethernet switch	0000 basic type	0000

Notes

- The elements mentioned above result in the **technical designation**. EL3314-0000-0016 is used in the example below.
- EL3314-0000 is the order identifier, in the case of "-0000" usually abbreviated to EL3314. "-0016" is the EtherCAT revision.
- The **order identifier** is made up of
 - family key (EL, EP, CU, ES, KL, CX, etc.)
 - type (3314)
 - version (-0000)
- The **revision** -0016 shows the technical progress, such as the extension of features with regard to the EtherCAT communication, and is managed by Beckhoff.
In principle, a device with a higher revision can replace a device with a lower revision, unless specified otherwise, e.g. in the documentation.
Associated and synonymous with each revision there is usually a description (ESI, EtherCAT Slave Information) in the form of an XML file, which is available for download from the Beckhoff web site.
From 2014/01 the revision is shown on the outside of the IP20 terminals, see Fig. "EL5021 EL terminal, standard IP20 IO device with batch number and revision ID (since 2014/01)".
- The type, version and revision are read as decimal numbers, even if they are technically saved in hexadecimal.

9.4.2 Version identification of IP67 modules

The serial number/ data code for Beckhoff IO devices is usually the 8-digit number printed on the device or on a sticker. The serial number indicates the configuration in delivery state and therefore refers to a whole production batch, without distinguishing the individual modules of a batch.

Structure of the serial number: **KK YY FF HH**

KK - week of production (CW, calendar week)
 YY - year of production
 FF - firmware version
 HH - hardware version

Example with serial number 12 06 3A 02:

12 - production week 12
 06 - production year 2006
 3A - firmware version 3A
 02 - hardware version 02

Exceptions can occur in the **IP67 area**, where the following syntax can be used (see respective device documentation):

Syntax: D ww yy x y z u

D - prefix designation
 ww - calendar week
 yy - year
 x - firmware version of the bus PCB
 y - hardware version of the bus PCB
 z - firmware version of the I/O PCB
 u - hardware version of the I/O PCB

Example: D.22081501 calendar week 22 of the year 2008 firmware version of bus PCB: 1 hardware version of bus PCB: 5 firmware version of I/O PCB: 0 (no firmware necessary for this PCB) hardware version of I/O PCB: 1

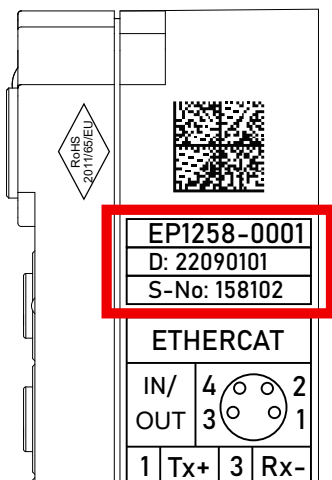

Fig. 16: EP1258-00001 IP67 EtherCAT Box with batch number/DateCode 22090101 and unique serial number 158102

9.4.3 Beckhoff Identification Code (BIC)

The Beckhoff Identification Code (BIC) is increasingly being applied to Beckhoff products to uniquely identify the product. The BIC is represented as a Data Matrix Code (DMC, code scheme ECC200), the content is based on the ANSI standard MH10.8.2-2016.

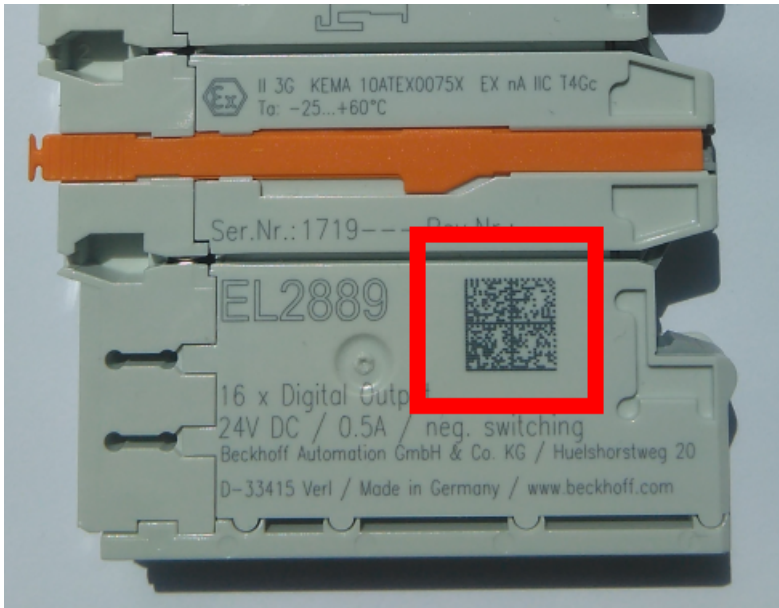

Fig. 17: BIC as data matrix code (DMC, code scheme ECC200)

The BIC will be introduced step by step across all product groups.

Depending on the product, it can be found in the following places:

- on the packaging unit
- directly on the product (if space suffices)
- on the packaging unit and the product

The BIC is machine-readable and contains information that can also be used by the customer for handling and product management.

Each piece of information can be uniquely identified using the so-called data identifier (ANSI MH10.8.2-2016). The data identifier is followed by a character string. Both together have a maximum length according to the table below. If the information is shorter, spaces are added to it.

Following information is possible, positions 1 to 4 are always present, the other according to need of production:

Position	Type of information	Explanation	Data identifier	Number of digits incl. data identifier	Example
1	Beckhoff order number	Beckhoff order number	1P	8	1P 072222
2	Beckhoff Traceability Number (BTN)	Unique serial number, see note below	SBTN	12	SBTN k4p562d7
3	Article description	Beckhoff article description, e.g. EL1008	1K	32	1K EL1809
4	Quantity	Quantity in packaging unit, e.g. 1, 10, etc.	Q	6	Q1
5	Batch number	Optional: Year and week of production	2P	14	2P 401503180016
6	ID/serial number	Optional: Present-day serial number system, e.g. with safety products	51S	12	51S 678294
7	Variant number	Optional: Product variant number on the basis of standard products	30P	32	30P F971, 2*K183
...					

Further types of information and data identifiers are used by Beckhoff and serve internal processes.

Structure of the BIC

Example of composite information from positions 1 to 4 and with the above given example value on position 6. The data identifiers are highlighted in bold font:

1P072222**SBTN**k4p562d7**1K**EL1809 **Q1** **51S**678294

Accordingly as DMC:



Fig. 18: Example DMC **1P**072222**SBTN**k4p562d7**1K**EL1809 **Q1** **51S**678294

BTN

An important component of the BIC is the Beckhoff Traceability Number (BTN, position 2). The BTN is a unique serial number consisting of eight characters that will replace all other serial number systems at Beckhoff in the long term (e.g. batch designations on IO components, previous serial number range for safety products, etc.). The BTN will also be introduced step by step, so it may happen that the BTN is not yet coded in the BIC.

NOTICE

This information has been carefully prepared. However, the procedure described is constantly being further developed. We reserve the right to revise and change procedures and documentation at any time and without prior notice. No claims for changes can be made from the information, illustrations and descriptions in this information.

9.4.4 Electronic access to the BIC (eBIC)

Electronic BIC (eBIC)

The Beckhoff Identification Code (BIC) is applied to the outside of Beckhoff products in a visible place. If possible, it should also be electronically readable.

Decisive for the electronic readout is the interface via which the product can be electronically addressed.

K-bus devices (IP20, IP67)

Currently, no electronic storage and readout is planned for these devices.

EtherCAT devices (IP20, IP67)

All Beckhoff EtherCAT devices have a so-called ESI-EEPROM, which contains the EtherCAT identity with the revision number. Stored in it is the EtherCAT slave information, also colloquially known as ESI/XML configuration file for the EtherCAT master. See the corresponding chapter in the EtherCAT system manual ([Link](#)) for the relationships.

The eBIC is also stored in the ESI-EEPROM. The eBIC was introduced into the Beckhoff I/O production (terminals, box modules) from 2020; widespread implementation is expected in 2021.

The user can electronically access the eBIC (if existent) as follows:

- With all EtherCAT devices, the EtherCAT master (TwinCAT) can read the eBIC from the ESI-EEPROM
 - From TwinCAT 3.1 build 4024.11, the eBIC can be displayed in the online view.
 - To do this, check the checkbox "Show Beckhoff Identification Code (BIC)" under EtherCAT → Advanced Settings → Diagnostics:

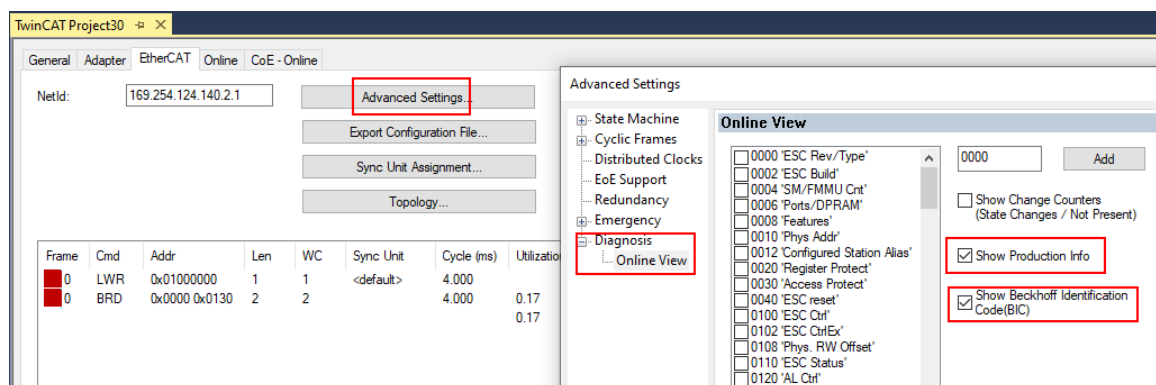

- The BTN and its contents are then displayed:

No	Addr	Name	State	CRC	Fw	Hw	Production Data	ItemNo	BTN	Description	Quantity	BatchNo	SerialNo
1	1001	Term 1 (EK1100)	OP	0.0	0	0	---						
2	1002	Term 2 (EL1018)	OP	0.0	0	0	2020 KW36 Fr	072222	k4p562d7	EL1809	1		678294
3	1003	Term 3 (EL3204)	OP	0.0	7	6	2012 KW24 Sa						
4	1004	Term 4 (EL2004)	OP	0.0	0	0	---	072223	k4p562d7	EL2004	1		678295
5	1005	Term 5 (EL1008)	OP	0.0	0	0	---						
6	1006	Term 6 (EL2008)	OP	0.0	0	12	2014 KW14 Mo						
7	1007	Term 7 (EK1110)	OP	0	1	8	2012 KW25 Mo						

- Note: as can be seen in the illustration, the production data HW version, FW version and production date, which have been programmed since 2012, can also be displayed with "Show Production Info".
- Access from the PLC: From TwinCAT 3.1. build 4024.24 the functions *FB_EcReadBIC* and *FB_EcReadBTN* are available in the Tc2_EtherCAT Library from v3.3.19.0 for reading into the PLC..
- In the case of EtherCAT devices with CoE directory, the object 0x10E2:01 can additionally be used to display the device's own eBIC; the PLC can also simply access the information here:

- The device must be in PREOP/SAFEOP/OP for access:

Index	Name	Flags	Value
1000	Device type	RO	0x015E1389 (22942601)
1008	Device name	RO	ELM3704-0000
1009	Hardware version	RO	00
100A	Software version	RO	01
100B	Bootloader version	RO	J0.1.27.0
1011:0	Restore default parameters	RO	> 1 <
1018:0	Identity	RO	> 4 <
10E2:0	Manufacturer-specific Identification C...	RO	> 1 <
10E2:01	SubIndex 001	RO	1P158442SBTN0008jckp1KELM3704 Q1 2P482001000016
10F0:0	Backup parameter handling	RO	> 1 <
10F3:0	Diagnosis History	RO	> 21 <
10F8	Actual Time Stamp	RO	0x170bfb277e

- The object 0x10E2 will be introduced into stock products in the course of a necessary firmware revision.
- From TwinCAT 3.1. build 4024.24 the functions *FB_EcCoEReadBIC* and *FB_EcCoEReadBTN* are available in the *Tc2_EtherCAT Library* from v3.3.19.0 for reading into the PLC.
- For processing the BIC/BTN data in the PLC, the following auxiliary functions are available in *Tc2_Uilities* from TwinCAT 3.1 build 4024.24 onwards
 - *F_SplitBIC*: The function splits the Beckhoff Identification Code (BIC) *sBICValue* into its components based on known identifiers and returns the recognized partial strings in a structure *ST_SplitBIC* as return value.
 - *BIC_TO_BTN*: The function extracts the BTN from the BIC and returns it as a value.
- Note: in the case of electronic further processing, the BTN is to be handled as a string(8); the identifier "SBTN" is not part of the BTN.
- Technical background
 The new BIC information is additionally written as a category in the ESI-EEPROM during the device production. The structure of the ESI content is largely dictated by the ETG specifications, therefore the additional vendor-specific content is stored with the help of a category according to ETG.2010. ID 03 indicates to all EtherCAT masters that they must not overwrite these data in case of an update or restore the data after an ESI update.
 The structure follows the content of the BIC, see there. This results in a memory requirement of approx. 50..200 bytes in the EEPROM.
- Special cases
 - If multiple, hierarchically arranged ESCs are installed in a device, only the top-level ESC carries the eBIC Information.
 - If multiple, non-hierarchically arranged ESCs are installed in a device, all ESCs carry the eBIC Information.
 - If the device consists of several sub-devices with their own identity, but only the top-level device is accessible via EtherCAT, the eBIC of the top-level device is located in the CoE object directory 0x10E2:01 and the eBICs of the sub-devices follow in 0x10E2:nn.

PROFIBUS, PROFINET, DeviceNet devices etc.

Currently, no electronic storage and readout is planned for these devices.

9.5 Support and Service

Beckhoff and their partners around the world offer comprehensive support and service, making available fast and competent assistance with all questions related to Beckhoff products and system solutions.

Beckhoff's branch offices and representatives

Please contact your Beckhoff branch office or representative for local support and service on Beckhoff products!

The addresses of Beckhoff's branch offices and representatives round the world can be found on her internet pages: www.beckhoff.com

You will also find further documentation for Beckhoff components there.

Support

The Beckhoff Support offers you comprehensive technical assistance, helping you not only with the application of individual Beckhoff products, but also with other, wide-ranging services:

- support
- design, programming and commissioning of complex automation systems
- and extensive training program for Beckhoff system components

Hotline: +49 5246 963 157
e-mail: support@beckhoff.com
web: www.beckhoff.com/support

Service

The Beckhoff Service Center supports you in all matters of after-sales service:

- on-site service
- repair service
- spare parts service
- hotline service

Hotline: +49 5246 963 460
e-mail: service@beckhoff.com
web: www.beckhoff.com/service

Headquarters Germany

Beckhoff Automation GmbH & Co. KG

Hülshorstweg 20
33415 Verl
Germany

Phone: +49 5246 963 0
e-mail: info@beckhoff.com
web: www.beckhoff.com

More Information:
www.beckhoff.com/epp3356-0022

Beckhoff Automation GmbH & Co. KG
Hülshorstweg 20
33415 Verl
Germany
Phone: +49 5246 9630
info@beckhoff.com
www.beckhoff.com

