

Documentation | EN

EP7402

2-channel motor controller box for roller conveyor systems



Table of contents

1	Foreword	5
1.1	Notes on the documentation	5
1.2	Safety instructions	6
1.3	Documentation issue status	7
2	Product overview	8
2.1	Module overview	8
2.2	EP7402-0057	9
2.2.1	Introduction	9
2.2.2	Technical data EP7402-0057	10
2.3	EP7402-0167	12
2.3.1	Introduction	12
2.3.2	Technical data EP7402-0167	13
2.4	Process image	15
2.4.1	Process image "PLC control"	15
2.4.2	Process image "Local control"	19
3	Selection of a motor	22
4	Mounting and cabling	23
4.1	Mounting	23
4.1.1	Dimensions	23
4.1.2	Fixing	24
4.1.3	Functional earth (FE)	24
4.2	Cabling	25
4.2.1	EP7402-0057 - Overview	25
4.2.2	EP7402-0167 - Overview	26
4.2.3	FE connection (EP7402-0167 only)	27
4.2.4	Supply voltages and EtherCAT	28
4.2.5	Motor connections of EP7402-0057	34
4.2.6	Motor connections of EP7402-0167	36
4.2.7	Digital input/outputs	38
4.3	UL Requirements	40
4.4	Disposal	41
5	Commissioning	42
5.1	Quick start	42
5.1.1	Step 1: Hardware Setup	42
5.1.2	Step 2: TwinCAT configuration	44
5.1.3	Step 3: parameterization	45
5.1.4	Step 4: Test run	50
5.1.5	Step 5: Final steps	52
5.2	Determining the "Mechanical to electrical ratio" experimentally	53
5.2.1	Firmware 04 and higher	53
5.2.2	Firmware 03 and lower	53
5.3	Fine-tuning parameters	54
5.3.1	Alignment phase and ramp-up phase	54

5.3.2	Velocity controller.....	54
5.4	Autoacknowledge: acknowledge errors automatically	55
5.4.1	Configuration of Autoacknowledge	55
5.4.2	Reading the state	55
5.5	ZPA: Zero Pressure Accumulation	56
5.5.1	Requirements.....	56
5.5.2	Basic principles	56
5.5.3	Cabling	60
5.5.4	ZPA communication via EtherCAT.....	62
5.5.5	Commissioning.....	64
5.5.6	State machine	66
5.5.7	Digital inputs and outputs in ZPA mode	68
5.6	Restore the delivery state	70
6	Troubleshooting	71
6.1	Diagnosis bits	72
6.2	Acknowledging errors.....	74
7	Decommissioning	75
8	Application Hints.....	76
8.1	Motor Diagnosis	76
9	CoE objects	77
9.1	Register.....	77
9.2	Object descriptions.....	79
9.2.1	Parameterization objects.....	79
9.2.2	Information objects.....	85
9.2.3	Standard objects	86
10	Appendix.....	87
10.1	Example motor parameters	87
10.2	General operating conditions	88
10.3	Accessories	89
10.4	Version identification of EtherCAT devices	90
10.4.1	General notes on marking.....	90
10.4.2	Version identification of IP67 modules.....	91
10.4.3	Beckhoff Identification Code (BIC).....	92
10.4.4	Electronic access to the BIC (eBIC).....	94
10.5	Support and Service.....	96

1 Foreword

1.1 Notes on the documentation

Intended audience

This description is only intended for the use of trained specialists in control and automation engineering who are familiar with the applicable national standards.

It is essential that the documentation and the following notes and explanations are followed when installing and commissioning these components.

The qualified personnel is obliged to always use the currently valid documentation.

The responsible staff must ensure that the application or use of the products described satisfy all the requirements for safety, including all the relevant laws, regulations, guidelines and standards.

Disclaimer

The documentation has been prepared with care. The products described are, however, constantly under development.

We reserve the right to revise and change the documentation at any time and without prior announcement.

No claims for the modification of products that have already been supplied may be made on the basis of the data, diagrams and descriptions in this documentation.

Trademarks

Beckhoff®, TwinCAT®, TwinCAT/BSD®, TC/BSD®, EtherCAT®, EtherCAT G®, EtherCAT G10®, EtherCAT P®, Safety over EtherCAT®, TwinSAFE®, XFC®, XTS® and XPlanar® are registered trademarks of and licensed by Beckhoff Automation GmbH. Other designations used in this publication may be trademarks whose use by third parties for their own purposes could violate the rights of the owners.

Patent Pending

The EtherCAT Technology is covered, including but not limited to the following patent applications and patents: EP1590927, EP1789857, EP1456722, EP2137893, DE102015105702 with corresponding applications or registrations in various other countries.



EtherCAT® is registered trademark and patented technology, licensed by Beckhoff Automation GmbH, Germany.

Copyright

© Beckhoff Automation GmbH & Co. KG, Germany.

The reproduction, distribution and utilization of this document as well as the communication of its contents to others without express authorization are prohibited.

Offenders will be held liable for the payment of damages. All rights reserved in the event of the grant of a patent, utility model or design.

1.2 Safety instructions

Safety regulations

Please note the following safety instructions and explanations!
Product-specific safety instructions can be found on following pages or in the areas mounting, wiring, commissioning etc.

Exclusion of liability

All the components are supplied in particular hardware and software configurations appropriate for the application. Modifications to hardware or software configurations other than those described in the documentation are not permitted, and nullify the liability of Beckhoff Automation GmbH & Co. KG.

Personnel qualification

This description is only intended for trained specialists in control, automation and drive engineering who are familiar with the applicable national standards.

Signal words

The signal words used in the documentation are classified below. In order to prevent injury and damage to persons and property, read and follow the safety and warning notices.

Personal injury warnings

⚠ DANGER

Hazard with high risk of death or serious injury.

⚠ WARNING

Hazard with medium risk of death or serious injury.

⚠ CAUTION

There is a low-risk hazard that could result in medium or minor injury.

Warning of damage to property or environment

NOTICE

The environment, equipment, or data may be damaged.

Information on handling the product



This information includes, for example:
recommendations for action, assistance or further information on the product.

1.3 Documentation issue status

Version	Comment
1.8	<ul style="list-style-type: none"> • Commissioning updated
1.7	<ul style="list-style-type: none"> • New functions from firmware 05 added. <ul style="list-style-type: none"> ◦ Autoacknowledge ◦ ZPA communication via EtherCAT • UL approval added
1.6	<ul style="list-style-type: none"> • New functions of firmware 04 added.
1.5	<ul style="list-style-type: none"> • EP7402-0167 added
1.4	<ul style="list-style-type: none"> • New functions from firmware 03 added, e.g. ZPA
1.3	<ul style="list-style-type: none"> • Structure update
1.2	<ul style="list-style-type: none"> • Technical data updated • Chapter "Troubleshooting" updated
1.1	<ul style="list-style-type: none"> • Hardware change at supply voltage output X60 • Accessories added
1.0	<ul style="list-style-type: none"> • First release

Firmware and hardware versions

This documentation refers to the firmware and hardware version that was applicable at the time the documentation was written.

The module features are continuously improved and developed further. Modules having earlier production statuses cannot have the same properties as modules with the latest status. However, existing properties are retained and are not changed, so that older modules can always be replaced with new ones.

Documentation version	EP7402-0057		EP7402-0167	
	Firmware	Hardware	Firmware	Hardware
1.7	05	04	05	00
1.6	04	03	04	00
1.5	03	03	03	00
1.4	03	03	-	-
1.3	01	03	-	-
1.2	01	03	-	-
1.1	01	03	-	-
1.0	01	02	-	-

The firmware and hardware version (delivery state) can be found in the batch number (D-number) printed on the side of the EtherCAT Box.

Syntax of the batch number (D-number)

D: WW YY FF HH

WW - week of production (calendar week)

YY - year of production

FF - firmware version

HH - hardware version

Example with D no. 29 10 02 01:

29 - week of production 29

10 - year of production 2010

02 - firmware version 02

01 - hardware version 01

Further information on this topic: [Version identification of EtherCAT devices \[► 90\]](#).

2 Product overview

2.1 Module overview

The following table shows the products described in this documentation and the main distinguishing features.

Module	Motor nominal voltage	Motor connections	Additional functions
EP7402-0057 [▶ 9]	18 ... 24 V _{DC}	M8 sockets, b-coded	<ul style="list-style-type: none">• EtherCAT junction• Supply voltage output• Motor brake outputs
EP7402-0167 [▶ 12]	18 ... 48 V _{DC}	M8 sockets, a-coded	<ul style="list-style-type: none">• Additional FE connection

2.2 EP7402-0057

2.2.1 Introduction



2-channel motor controller box for roller conveyor systems

The EP7402-0057 EtherCAT Box offers two outputs with integrated MDR controller for the direct connection of 24 V DC conveyor roller motors or other BLDC motors with max. 3.5 A. Eight additional digital inputs/outputs enable connection of e.g. photoelectric switches and communication between the box modules in operation without PLC.

The EP7402-0057 takes over the complete control of a roller motor independently of the manufacturer of conveyor or motor. Maximum rated current, acceleration or deceleration ramps and various other parameters can be configured and allow for a wide range of adaptations to different applications. The control of the motors is sensorless.

The EtherCAT Box with IP67 protection rating measures only 174 mm x 60 mm x 36.5 mm and can be easily mounted in standard C-channel or L-brackets on the conveyor frame. It requires no additional protective covering. Power supply and EtherCAT communication are realized via a B23 ENP connector with a current carrying capacity of 28 A/45 °C. In conveyor operation the EP7402-0057 can also be operated without PLC and provides functions such as ZPA (Zero Pressure Accumulation), single or block discharge. Further EtherCAT devices such as digital and analog I/Os, barcode readers or safety devices can be connected to the additional EtherCAT junction.

EP7402-0057 does not provide overtemperature detection of the motor.

NOTICE

Brake chopper required

Overvoltage peaks can occur on the supply voltage U_p which can destroy the device.

The overvoltage peaks occur during braking operations of the motor or by manually moving objects on the roller conveyor.

- Use a brake chopper to dissipate overvoltages.
E.g. [EP9576-1032](#) or [EL9576](#).

Quick links

[Technical data EP7402-0057](#) [▶ 10]

[Process image](#) [▶ 15]

[Dimensions](#) [▶ 23]

[Connections](#) [▶ 25]

[Quick start](#) [▶ 42]

2.2.2 Technical data EP7402-0057

All values are typical values over the entire temperature range, unless stated otherwise.

EtherCAT	
Connection	Input and downstream connection: B23 ENP hybrid connector EtherCAT junction: M8 socket, 4-pin, green
Electrical isolation	500 V

Supply voltages	
Connection	B23 ENP hybrid connector
U_S nominal voltage	24 V _{DC} (-15 % / +20 %)
U_S sum current: $I_{S,sum}$	max. 28 A at 45°C ¹⁾
Current consumption from U_S	150 mA + output currents of the digital outputs + sensor supply + output current from the output X60
U_P nominal voltage	18 ... 24 V _{DC}
U_P sum current: $I_{P,sum}$	max. 28 A at 45 °C ¹⁾
Current consumption from U_P	Output currents for the motors + output current for the motor brake
Undervoltage detection	18 V _{DC}
Overvoltage detection	30 V _{DC}

¹⁾ This value corresponds to the current carrying capacity of the connectors.

Motor channels	
Number	2
Motor type	3-phase BLDC roller motors
Connection	2x M8 socket, b-coded
Cable length	max. 30 m
Motor inductance	min. 200 µH
Rotary encoder	No rotary encoder needed
Motor voltage	18 ... 24 V _{DC} from the peripheral voltage U_P
Continuous current per channel	max. 3.5 A _{rms}
Peak current per channel	<ul style="list-style-type: none"> Firmware 03 and higher: max. 12.0 A_{rms} for approx. 1 s Firmware 02 and lower: max. 5.0 A_{rms} for approx. 1 s
Rotating field velocity	<ul style="list-style-type: none"> Firmware 03 and higher: max. 599 Hz = 215640 °/s = 35940 rpm ²⁾ Firmware 02 and lower: max. 72000 °/s = 12000 rpm ²⁾
PWM clock frequency	16 kHz
Current controller frequency	32 kHz

²⁾ Do not confuse the rotating field velocity with the motor velocity or the roller velocity.

Digital inputs/outputs	
Number	8
Connections	4x M8 socket
Cable length	max. 30 m
Sensor power supply U_{S1}	24 V _{DC} from the control voltage U_S max. 0.5 A, short-circuit proof
Input specification	
Characteristics	Type 3 according to EN 61131-2, compatible with type 1
Input filter	10 μ s
Output specification	
Nominal voltage	24 V _{DC} (-15 % / +20 %) from the control voltage U_S
Output current	max. 0.5 A per output, individually short-circuit proof

Housing data	
Weight	750 g
Installation position	variable

Environmental conditions	
Ambient temperature during operation	-25 ... +60 °C -25 ... +55 °C according to cURus
Ambient temperature during storage	-40...+85 °C
Degree of pollution	2, for use under UL conditions
Vibration resistance, shock resistance	conforms to EN 60068-2-6 / EN 60068-2-27 Additional checks
EMC immunity / emission	conforms to EN 61000-6-2 / EN 61000-6-4
Protection rating	IP65, IP66, IP67 (according to EN 60529)

Approvals/markings	
Approvals/markings *)	CE, cURus [▶ 40]

*) Real applicable approvals/markings see type plate on the side (product marking).

2.3 EP7402-0167

2.3.1 Introduction



2-channel motor controller box for roller conveyor systems

The EP7402-0167 EtherCAT Box provides two outputs with integrated MDR controller for direct connection of 48 V_{DC} roller motors or other BLDC motors with max. 3.5 A. Eight additional digital inputs/outputs allow the connection of e.g. light barriers and the communication between the modules in PLC-less operation.

The EP7402-0167 takes over the complete control of the roller motor irrespective of the manufacturer of the conveyor or the motor. The connection is made directly to the three phases of the motor. Maximum nominal current, start-up or deceleration ramps as well as various other parameters can be configured, which allows wide adaptation to different applications. The motors are controlled without sensors.

Measuring just 174 mm x 60 mm x 36.5 mm, the IP67-rated EtherCAT Box can be easily mounted in standard side profiles on the conveyor frame. It does not require an additional protective cover. Power supply and EtherCAT communication are done via a B23 ENP connector with a current carrying capacity of 28 A / 45 °C. In pure conveying mode, the EP7402-0167 can also be operated without a PLC and provides functions such as ZPA (Zero Pressure Accumulation), singulated or train release.

EP7402-0167 does not provide overtemperature detection of the motor.

NOTICE

Brake chopper required

Overvoltage peaks can occur on the supply voltage U_p which can destroy the device.

The overvoltage peaks occur during braking operations of the motor or by manually moving objects on the roller conveyor.

- Use a brake chopper to dissipate overvoltages.
E.g. [EP9576-1032](#) or [EL9576](#).

Quick links

[Technical data](#) [▶ 13]

[Process image](#) [▶ 15]

[Dimensions](#) [▶ 23]

[Connections](#) [▶ 26]

[Quick start](#) [▶ 42]

2.3.2 Technical data EP7402-0167

All values are typical values over the entire temperature range, unless stated otherwise.

EtherCAT	
Connection	B23 ENP hybrid connector
Electrical isolation	500 V

Supply voltages	
Connection	B23 ENP hybrid connector
U_S nominal voltage	24 V _{DC} (-15 % / +20 %)
U_S sum current: $I_{S,sum}$	max. 28 A at 45°C ¹⁾
Current consumption from U_S	150 mA + output currents of the digital outputs + sensor power supply
U_P nominal voltage range	18 ... 48 V _{DC}
U_P sum current: $I_{P,sum}$	max. 28 A at 45 °C ¹⁾
Current consumption from U_P	Output currents for the motors + output current for the motor brake
U_P undervoltage detection	18 V
U_P overvoltage detection	60 V

¹⁾ This value corresponds to the current carrying capacity of the connectors.

Motor channels	
Number	2
Motor type	3-phase BLDC roller motors
Connection	2x M8 socket, b-coded
Cable length	max. 30 m
Motor inductance	min. 200 µH
Rotary encoder	No rotary encoder needed
Motor voltage	18 ... 48 V _{DC} from the supply voltage U_P
Continuous current per channel	3.5 A _{rms}
Peak current per channel	12.0 A _{rms} for approx. 1 s
Rotating field velocity	599 Hz ²⁾
PWM clock frequency	16 kHz
Current controller frequency	32 kHz

²⁾ Do not confuse the rotating field velocity with the motor velocity or the roller velocity.

Digital inputs/outputs	
Number	8
Connections	4x M8 socket
Cable length	max. 30 m
Sensor power supply U_{S1}	24 V _{DC} from the control voltage U_S max. 0.5 A, short-circuit proof
Input specification	
Characteristics	Type 3 according to EN 61131-2, compatible with type 1
Input filter	10 μ s
Output specification	
Nominal voltage	24 V _{DC} (-15 % / +20 %) from the control voltage U_S
Output current	max. 0.5 A per output, individually short-circuit proof

Housing data	
Weight	750 g
Installation position	variable

Environmental conditions	
Ambient temperature during operation	-25 ... +60 °C -25 ... +55 °C according to cURus
Ambient temperature during storage	-40...+85 °C
Degree of pollution	2, for use under UL conditions
Vibration resistance, shock resistance	conforms to EN 60068-2-6 / EN 60068-2-27 Additional checks
EMC immunity / emission	conforms to EN 61000-6-2 / EN 61000-6-4
Protection rating	IP65, IP66, IP67 (according to EN 60529)

Approvals/markings	
Approvals/markings ^{*)}	CE, cURus [▶ 40]

*) Real applicable approvals/markings see type plate on the side (product marking).

2.4 Process image

The scope of the process image is adjustable.

The EP7402 has two predefined variants of the process image, called "Predefined PDO Assignments".

The factory default setting is "PLC control".

Predefined PDO Assignment	Use
"PLC control" [▶ 15]	Operation with a controller as central intelligence
"Local control" [▶ 19]	ZPA operation

2.4.1 Process image "PLC control"

- ▲ Box 1 (EP7402)
 - ▶ DI Inputs
 - ▶ STM Status Channel 1
 - ▶ STM Synchron info data Channel 1
 - ▶ STM Status Channel 2
 - ▶ STM Synchron info data Channel 2
 - ▶ STM Inputs Device
 - ▶ DO Outputs
 - ▶ STM Control Channel 1
 - ▶ STM Target Velocity Channel 1
 - ▶ STM Control Channel 2
 - ▶ STM Target Velocity Channel 2
 - ▶ WcState
 - ▶ InfoData

In the following sections, the letter *n* serves as a placeholder for the channel number.

Screenshots showing process data objects of channel 1 are used as examples for both channels. The process data objects of channel 1 and channel 2 have the same content structure.

DI Inputs

- ▲ DI Inputs
 - ▶ Input 1
 - ▶ Input 2
 - ▶ Input 3
 - ▶ Input 4
 - ▶ Control input 1
 - ▶ Control input 2
 - ▶ Control input 3
 - ▶ Control input 4









The input variables map the logic level of the digital inputs/outputs in the process data.

Make sure that the corresponding output variable in the "DO Outputs" process data object [[▶ 17](#)] is set to 0 if you want to use a digital input/output as an input.

The different designations "Input x" and "Control input x" are only relevant in ZPA mode. In operation without ZPA all digital inputs are equivalent.

[Assignment of connections and process data](#) [[▶ 18](#)]

STM Status Channel *n*

- ▲  STM Status Channel 1
 - ▲  Status
 -  Ready to enable
 -  Ready
 -  Warning
 -  Error
 -  Moving positive
 -  Moving negative
 -  TxPDO Toggle

The input variables "Status" contain the status bits of the motor channels.

Ready to enable

- TRUE: all prerequisites for enabling the motor are fulfilled.
- FALSE: the motor channel cannot be enabled (output variable "enable") because an error message is pending.

Ready

- TRUE: the motor is being energized.

Warning

- TRUE: the motor channel is in a borderline state.

Error

- TRUE: the motor channel has been disabled due to an error message. To determine the cause of the error, see chapter [Diagnosis bits \[► 72\]](#).

Moving positive

- TRUE: the motor velocity is higher than zero.





Moving negative

- TRUE: the motor velocity is lower than zero.

TxPDO Toggle

This bit is inverted each time the status bit is updated.

STM Synchron info data Channel *n*

- ▲  STM Synchron info data Channel 1
 -  Info data 1
 -  Info data 2
 -  Info data 3

The input variables "Info data x" contain measured values. You can choose which measured values are mapped to these variables in the CoE directory:

- Select the measured values for Channel 1 in CoE object [8022 \[► 80\]](#).
- Select the measured values for Channel 2 in CoE object [8032 \[► 80\]](#).

STM Inputs Device

- Device undervoltage
 - Device overvoltage
 - Overtemperature warning
 - Overtemperature error
 - General hardware error
 - Channel 1 openload
 - Channel 1 short circuit
 - Channel 1 motor overload I2T warning
 - Channel 1 motor overload I2T error
 - Channel 1 amplifier overload I2T warning
 - Channel 1 amplifier overload I2T error
 - Channel 1 in limit
 - Channel 1 commutation error
 - Channel 2 openload
 - Channel 2 short circuit
 - Channel 2 motor overload I2T warning
 - Channel 2 motor overload I2T error
 - Channel 2 amplifier overload I2T warning
 - Channel 2 amplifier overload I2T error
 - Channel 2 in limit
 - Channel 2 commutation error

"STM Inputs Device" contains diagnostic bits that you can use to narrow down the cause of a warning or an error. See chapter [Diagnosis bits \[► 72\]](#).

DO Outputs

- Output 1
 - Output 2
 - Output 3
 - Output 4
 - Control output 1
 - Control output 2
 - Control output 3
 - Control output 4

Output variables for the digital inputs/outputs.

The different designations "Output x" and "Control output x" are only relevant in ZPA mode. In operation without ZPA, all eight digital outputs are equivalent.

STM Control Channel *n*

- Enable
 - Reset
 - Invert direction
 - Brake output

Enable

This bit enables the motor channel. The bit has no effect if the variable [Ready to enable \[► 16\]](#) is FALSE.

Reset

Apply a rising signal edge to this bit to acknowledge an error.





Invert direction

If this bit is set, the [setpoint velocity \[► 18\]](#) is multiplied by "-1" to change the direction.

Brake output (EP7402-0057 only)

Output variable for switching the motor brake output.

STM Target Velocity Channel *n*

-  STM Target Velocity Channel 1
 -  Velocity
 -  Acceleration
 -  Deceleration

Velocity

Target velocity.
 This value is the setpoint for the velocity controller. However, any value less than parameter 80n00:09 start velocity [[▶ 79](#)], is interpreted as zero.

Unit: °/s

Acceleration

This value determines the maximum acceleration. If this value is zero, the acceleration is not limited.









































Unit: °/s²

Deceleration

This value determines the maximum deceleration. A deceleration is not limited if this value is zero.

Unit: °/s²









2.4.1.1 Assignment of connections and process data

Connector			Process data	
Name	Pin	Function	Input	Output
X01	2	Digital in-/output	 DI Inputs  Input 2	 DO Outputs  Output 2
	4		 DI Inputs  Input 1	 DO Outputs  Output 1
X02	2	Digital in-/output	 DI Inputs  Control input 2	 DO Outputs  Control output 2
	4		 DI Inputs  Control input 1	 DO Outputs  Control output 1
X05	2	Digital in-/output	 DI Inputs  Input 4	 DO Outputs  Output 4
	4		 DI Inputs  Input 3	 DO Outputs  Output 3
X06	2	Digital in-/output	 DI Inputs  Control input 4	 DO Outputs  Control output 4
	4		 DI Inputs  Control input 3	 DO Outputs  Control output 3
X20		Motor	 STM Status Channel 1  STM Synchron info data Channel 1	 STM Control Channel 1  STM Target Velocity Channel 1
X21		Motor	 STM Status Channel 2  STM Synchron info data Channel 2	 STM Control Channel 2  STM Target Velocity Channel 2

2.4.2 Process image "Local control"

In the factory setting, "Local control" is disabled. It is enabled when the ZPA operation is put into operation. See chapter [Commissioning \[▶ 64\]](#).























If the Predefined PDO Assignment "Local control" is enabled, the process image contains variables for monitoring and controlling the ZPA operation.

- ▶  Box 1 (EP7402)
 - ▶  STM Inputs Device
 - ▶  ZNCTRL Inputs Channel 1
 - ▶  ZNCTRL Inputs Channel 2
 - ▶  ZNCTRL Outputs Channel 1
 - ▶  ZNCTRL Outputs Channel 2
 - ▶  WcState
 - ▶  InfoData

In the following sections, the letter *n* serves as a placeholder for the channel number.











Screenshots showing process data objects of channel 1 are used as examples for both channels. The process data objects of channel 1 and channel 2 have the same content structure.

STM Inputs Device

- ▶  STM Inputs Device
 - ▶  Device Diag
 - ▶  Device undervoltage
 - ▶  Device overvoltage
 - ▶  Overtemperature warning
 - ▶  Overtemperature error
 - ▶  General hardware error
 - ▶  Channel 1 openload
 - ▶  Channel 1 short circuit
 - ▶  Channel 1 motor overload I2T warning
 - ▶  Channel 1 motor overload I2T error
 - ▶  Channel 1 amplifier overload I2T warning
 - ▶  Channel 1 amplifier overload I2T error
 - ▶  Channel 1 in limit
 - ▶  Channel 1 commutation error
 - ▶  Channel 2 openload
 - ▶  Channel 2 short circuit
 - ▶  Channel 2 motor overload I2T warning
 - ▶  Channel 2 motor overload I2T error
 - ▶  Channel 2 amplifier overload I2T warning
 - ▶  Channel 2 amplifier overload I2T error
 - ▶  Channel 2 in limit
 - ▶  Channel 2 commutation error

"STM Inputs Device" contains diagnostic bits that you can use to narrow down the cause of a warning or an error. See chapter [Diagnosis bits \[▶ 72\]](#).

ZNCTRL Inputs Channel n

- ▲  ZNCTRL Inputs Channel 1
 - ▲  Status
 -  Moving
 -  Zone sensor input
 -  Upstream control input value
 -  Upstream control output value
 -  Downstream control input value
 -  Downstream control output value
 -  Reset Input Value
 -  Zone state

Moving

EP7402 currently drives the motor. The zone is conveying.

Zone sensor input

The current state of the zone sensor.

Upstream control input value

The current state of the control signal received by the controller from the upstream zone.

With the value 1, the preceding zone announces a package.

See chapter [ZPA operation with EP7402](#) [► 59].

Upstream control output value

The current signal level of the control signal that the controller sends to the upstream zone.

The value 1 means that the zone is free.

See chapter [ZPA operation with EP7402](#) [► 59].

Downstream control input value

The current signal level of the control signal received by the controller from the downstream zone.

The value 1 means that the following zone is free.

See chapter [ZPA operation with EP7402](#) [► 59].

Downstream control output value

The current signal level of the control signal that the controller sends to the downstream zone.

With the value 1 the controller announces a package.

See chapter [ZPA operation with EP7402](#) [► 59].







Reset input value

The current state of the external reset input.

Zone state

The current state of the ZPA state machine. See chapter [State machine](#) [► 66].

ZNCTRL Outputs Channel n

- ▲  ZNCTRL Outputs Channel 1
 - ▲  Control
 -  Reset
 -  Disable
 -  Upstream PLC input value
 -  Downstream PLC input value

Reset

Apply a rising signal edge to this bit to acknowledge an error.

Disable

Disable ZPA mode for this zone.

Upstream PLC input value

(available from firmware 05)

Variable for ZPA communication via EtherCAT. See chapter [ZPA communication via EtherCAT](#) [[▶ 62](#)].

Downstream PLC input value

(available from firmware 05)

Variable for ZPA communication via EtherCAT. See chapter [ZPA communication via EtherCAT](#) [[▶ 62](#)].

2.4.2.1 Process data for digital inputs/outputs (optional)

NOTICE

Disturbance of the ZPA mode

If you switch the digital outputs via the process data, the ZPA communication may be disturbed.

- Observe the instructions in chapter [Digital inputs and outputs in ZPA mode](#) [[▶ 68](#)].

In ZPA mode, you can optionally activate the process data for controlling and reading the digital inputs/outputs at sockets X01, X02, X05 and X06.

See chapter [Digital inputs and outputs in ZPA mode](#) [[▶ 68](#)].

3 Selection of a motor

Check the following motor parameters to find out whether a motor is suitable for operation with an EP7402. A motor is only suitable if all motor parameters are within the permissible range.

The permissible ranges for the individual motor parameters can be found in the technical data:

- [Technical data EP7402-0057 \[► 10\]](#)
- [Technical data EP7402-0167 \[► 13\]](#)

Motor type

The motor must be a three-phase BLDC motor without an integrated motor controller.

Winding inductance

The winding inductance of the motor must be greater than the minimum permissible winding inductance.

Electrical time constant

The formula for calculating the electrical time constant of the motor is:

$$\tau = \frac{L}{R}$$

τ : electrical time constant

L: winding inductance

R: winding resistance

The electrical time constant must be greater than the PWM period duration:

$$\tau > \frac{1}{f_{PWM}}$$

τ : electrical time constant

f_{PWM} : PWM clock frequency

Nominal speed

The nominal speed of the motor must be less than or equal to the maximum achievable speed.

$$n_{max} = \frac{f_{rot}}{2 \times p \times i}$$

n_{max} : maximum achievable speed

f_{rot} : rotating field velocity

p : number of pole pairs

i: gearbox ratio.

Example: i = 2 for a transmission ratio of 2:1.

Nominal current

The nominal current of the motor must be less than or equal to the maximum continuous current that the EP7402 can supply.

4 Mounting and cabling

4.1 Mounting

4.1.1 Dimensions

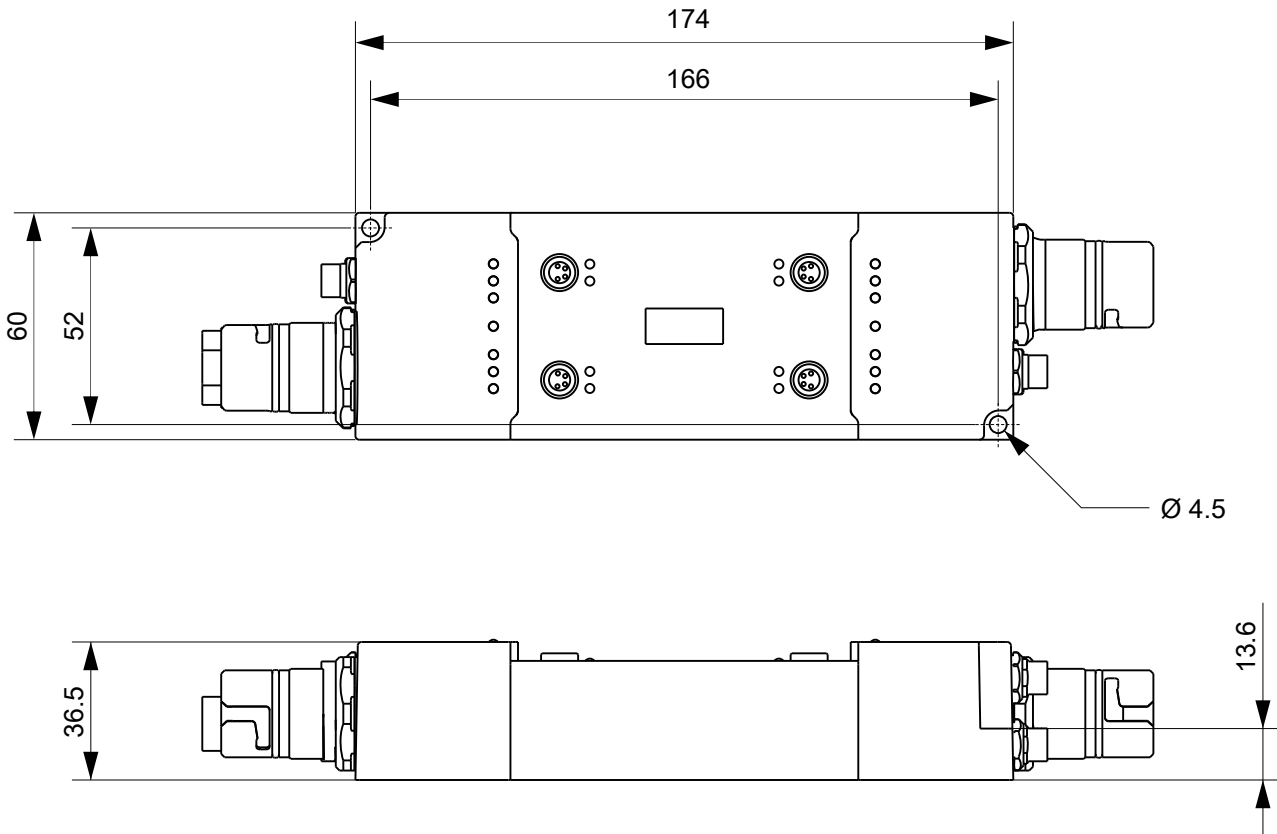

This figure shows the dimensions of EP7402-0057 as an example.
The dimensions of EP7402-0057 and EP7402-0167 are identical.

All dimensions are given in millimeters.
The drawing is not true to scale.

Housing features

Housing material	PA66 (polyamide)
Sealing compound	polyurethane
Mounting	two mounting holes Ø 4.5 mm for M4
Metal parts	brass, nickel-plated
Contacts	CuZn, gold-plated
Power feed through	max. 28 A at 45°C
Installation position	variable
Protection class	IP65, IP66, IP67 (conforms to EN 60529) when screwed together
Dimensions (H x W x D)	approx. 174 x 60 x 36.5 mm (without connectors)

4.1.2 Fixing

NOTICE

Dirt during assembly

Dirty connectors can lead to malfunctions. Protection class IP67 can only be guaranteed if all cables and connectors are connected.

- Protect the plug connectors against dirt during the assembly.

Mount the module with two M4 screws on the fastening holes in the corners of the module. The fastening holes have no thread.

4.1.3 Functional earth (FE)

Ground the FE wire of the supply line connected to X70 [► 28].

The FE potential is forwarded to the FE pin of X71. If several devices are connected in series, only the FE wire of the first supply line must therefore be grounded.

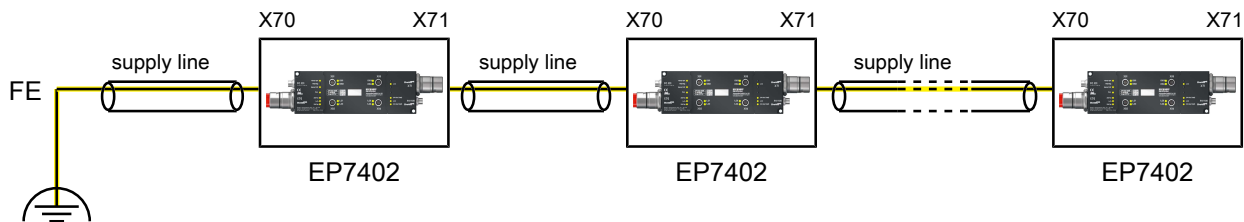

EP7402-0057

You can tap the FE potential at the connector housings of X70 and X71: use the nuts of X70 and X71 to screw on a metal sheet. In this way, EP7402-0057 can be connected to the grounded machine bed.

EP7402-0167

The EP7402-0167 has a separate ground connection. See chapter [FE connection \(EP7402-0167 only\)](#) [► 27].

4.2 Cabling

4.2.1 EP7402-0057 - Overview

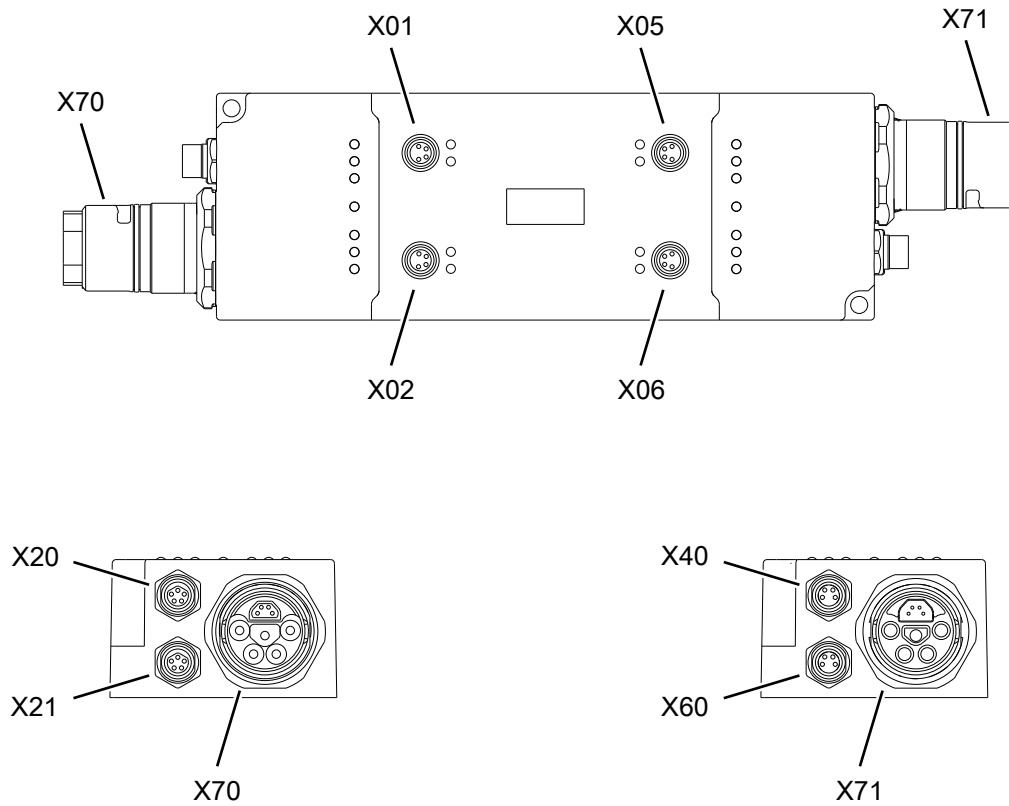

Name	Function	Ether-CAT port	Connector type	Tightening torque
X01	Digital input/outputs [▶ 38]	-	M8 socket	0.4 Nm
X02			M8 socket	0.4 Nm
X05			M8 socket	0.4 Nm
X06			M8 socket	0.4 Nm
X20	Motor channel 1 [▶ 34]	-	M8 socket, b-coded	0.4 Nm
X21	Motor channel 2 [▶ 34]	-	M8 socket, b-coded	0.4 Nm
X40	EtherCAT junction [▶ 31]	B	M8 socket	0.4 Nm
X60	Supply voltage output [▶ 32]	-	M8 socket	0.4 Nm
X70	Supply voltage and EtherCAT input [▶ 28]	A	B23 ENP	-
X71	Supply voltage and EtherCAT downstream connection [▶ 28]	C	B23 ENP	-

Suitable connection cables can be found in the chapter [Accessories](#) [[▶ 89](#)].

4.2.2 EP7402-0167 - Overview

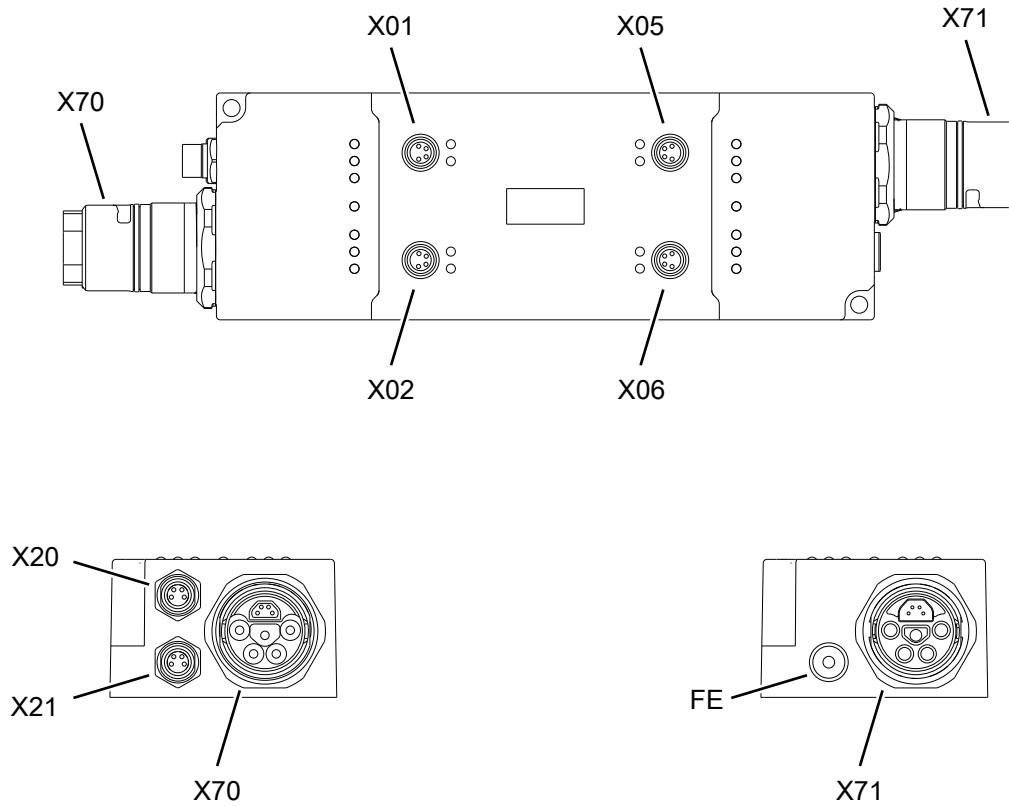

Name	Function	Ether-CAT port	Connector type	Tightening torque
FE	Ground connection [▶ 27]	-	M3 socket	-
X01	Digital input/outputs [▶ 38]	-	M8 socket	0.4 Nm
X02			M8 socket	0.4 Nm
X05			M8 socket	0.4 Nm
X06			M8 socket	0.4 Nm
X20	Motor channel 1 [▶ 34]	-	M8 socket	0.4 Nm
X21	Motor channel 2 [▶ 34]	-	M8 socket	0.4 Nm
X70	Supply voltage and EtherCAT input [▶ 28]	A	B23 ENP	-
X71	Supply voltage and EtherCAT downstream connection [▶ 28]	C	B23 ENP	-

Suitable connection cables can be found in the chapter [Accessories \[▶ 89\]](#).

4.2.3 FE connection (EP7402-0167 only)

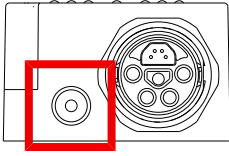

The FE connection is designed as an M3 socket. It is directly connected to the "FE" wire of the supply voltage connections X70 and X71.

4.2.4 Supply voltages and EtherCAT

4.2.4.1 Input and forwarding

⚠ WARNING

Power supply from SELV/PELV power supply unit!

SELV/PELV circuits (Safety Extra Low Voltage, Protective Extra Low Voltage) according to IEC 61010-2-201 must be used to supply this device.

Notes:

- SELV/PELV circuits may give rise to further requirements from standards such as IEC 60204-1 et al, for example with regard to cable spacing and insulation.
- A SELV (Safety Extra Low Voltage) supply provides safe electrical isolation and limitation of the voltage without a connection to the protective conductor, a PELV (Protective Extra Low Voltage) supply also requires a safe connection to the protective conductor.

⚠ CAUTION

Observe the UL requirements

- When operating under UL conditions, observe the warnings in the chapter [UL Requirements](#) [▶ 40].

NOTICE

Brake chopper required

Overvoltage peaks can occur on the supply voltage U_p which can destroy the device.

The overvoltage peaks occur during braking operations of the motor or by manually moving objects on the roller conveyor.

- Use a brake chopper to dissipate overvoltages.
E.g. [EP9576-1032](#) or [EL9576](#).

The EtherCAT Box is supplied with two supply voltages. The supply voltages are electrically isolated in the EtherCAT Box.

- Control voltage U_s
- Peripheral voltage U_p

Redirection of the supply voltages

You can connect several EP7402 in series by forwarding the supply voltages and EtherCAT via X71 to the respective subsequent device.

NOTICE

Note the maximum current

When forwarding the supply voltages U_s and U_p , make sure that the current of 28 A at 45 °C permitted for the connectors is not exceeded:

Pin assignment

NOTICE

U_p is not protected against polarity reversal

Defect possible through polarity reversal.

- Make sure that the supply voltage U_p is connected correctly.

Input X70

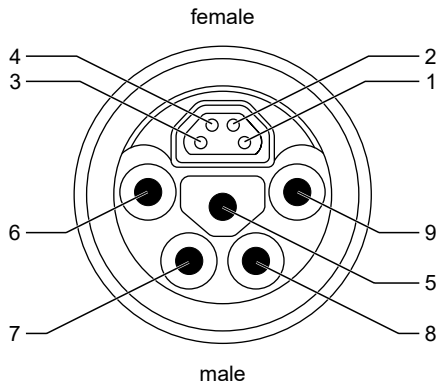

Downstream connection X71

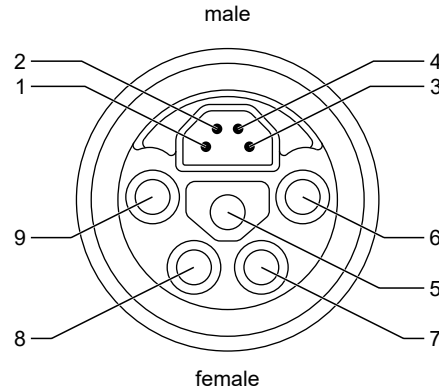

Pin	Wire color ¹⁾	Function	
		EP7402-0057	EP7402-0167
1	yellow	EtherCAT Tx +	EtherCAT Tx +
2	white	EtherCAT Rx +	EtherCAT Rx +
3	blue	EtherCAT Rx -	EtherCAT Rx -
4	orange	EtherCAT Tx -	EtherCAT Tx -
5	green/yellow	FE	FE
6	gray	GND _P	GND _P
7	black	U _p : 24 V _{DC}	U _p : 48 V _{DC}
8	blue	GND _S	GND _S
9	brown	U _S : 24 V _{DC}	U _S : 24 V _{DC}

¹⁾ The wire colors apply to cables of the type ZK7314-3xxx-Axxx. See chapter [Accessories](#) [► 89].

Connection diagram

This diagram shows the correct connection of the supply voltages at the supply voltage input X70.

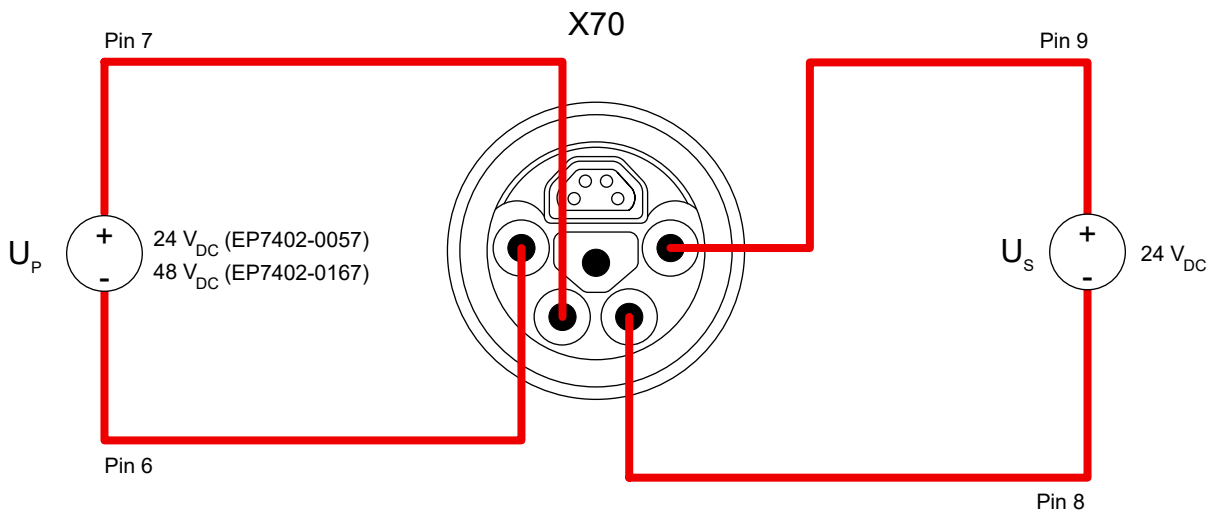

4.2.4.1.1 Status LEDs

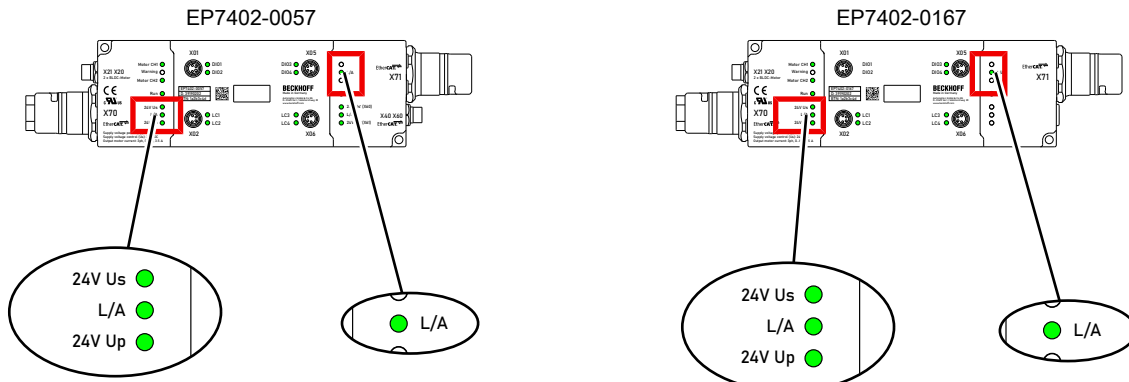

LED	Signal	Meaning
24V Us	off	The supply voltage U_s is not available.
	green illuminated	The supply voltage U_s is available.
L/A	off	No connection to the connected EtherCAT device.
	green illuminated	LINK: connection to the connected EtherCAT device.
	flashing green	ACT: communication with the connected EtherCAT device.
24V Up	off	The supply voltage U_p is not available.
	green illuminated	The supply voltage U_p is available.

4.2.4.1.2 Conductor losses

Take into account the voltage drop on the supply line when planning a system. Avoid the voltage drop being so high that the supply voltage at the box lies below the minimum nominal voltage. Variations in the voltage of the power supply unit must also be taken into account.

Voltage drop on the supply line

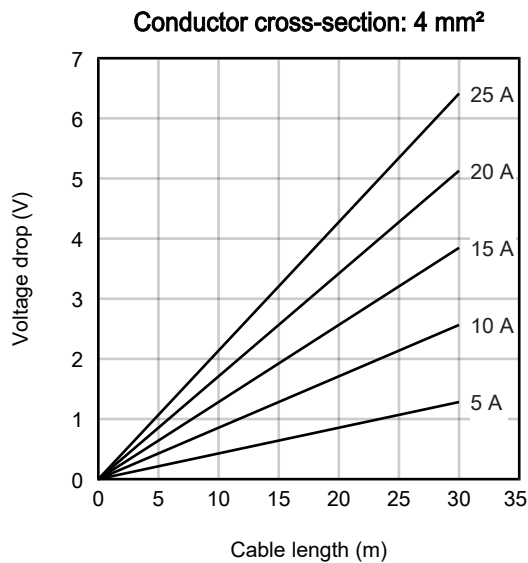

4.2.4.2 EtherCAT junction X40 (EP7402-0057 only)

NOTICE

Risk of confusion

M8 connectors for supply voltages have the same design as M8 connectors for EtherCAT. Observe the color coding of the connectors in order to avoid incorrect insertion:

- black: Supply voltages
- green: EtherCAT



Fig. 1: M8 socket

EtherCAT	M8 socket	Core colors		
Signal	Contact	ZB9010, ZB9020, ZB9030, ZB9032, ZK1090-6292, ZK1090-3xxx-xxxx	ZB9031 and old versions of ZB9030, ZB9032, ZK1090-3xxx-xxxx	TIA-568B
Tx +	1	yellow ¹⁾	orange/white	white/orange
Tx -	4	orange ¹⁾	orange	orange
Rx +	2	white ¹⁾	blue/white	white/green
Rx -	3	blue ¹⁾	blue	green
Shield	Housing	Shield	Shield	Shield

¹⁾ Core colors according to EN 61918

i Adaptation of core colors for cables ZB9030, ZB9032 and ZK1090-3xxxx-xxxx

For standardization, the core colors of the ZB9030, ZB9032 and ZK1090-3xxx-xxxx cables have been changed to the EN61918 core colors: yellow, orange, white, blue. So there are different color codes in circulation. The electrical properties of the cables have been retained when the core colors were changed.

Suitable connection cables can be found in the chapter [Accessories](#) [▶ 89].

4.2.4.2.1 Status LED

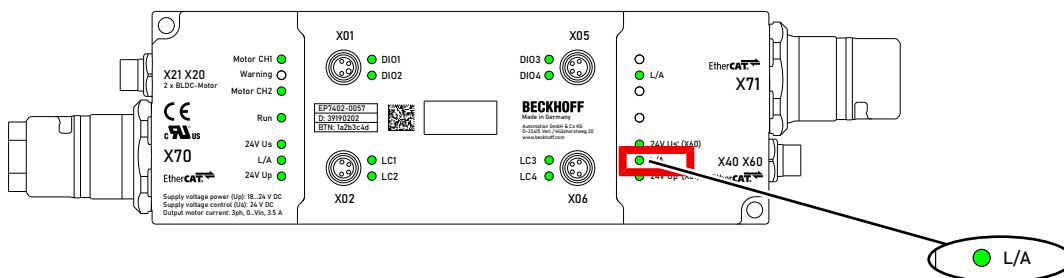

LED	Signal	Meaning
L/A	off	No connection to the connected EtherCAT device.
	green illuminated	LINK: connection to the connected EtherCAT device
	flashing green	ACT: communication with the connected EtherCAT device

4.2.4.3 Supply voltage output X60 (EP7402-0057 only)

The supply voltage output is intended for EtherCAT devices that are connected to [EtherCAT junction X40](#) [[▶ 31](#)].

⚠ CAUTION

The outgoing peripheral voltage U_p' is *not* switched off when the incoming peripheral voltage U_p is switched off. (from hardware version 03)

Actuators at the supply voltage output remain active.

- To safely switch off actuators at the supply voltage output, use [TwinSAFE](#) components.

NOTICE

The outgoing supply voltages are *not* electrically isolated. (from hardware version 03)

The analog specifications of EtherCAT Box modules with analog inputs or outputs may not be met under certain circumstances.



Fig. 2: M8 socket

Contact	Symbol	Description	Wire color
1	24V $U_{s'}$	Control voltage	Brown
2	24V $U_{p'}$	Peripheral voltage ¹⁾	White
3	GND	Common ground potential for both output voltages ²⁾	Blue
4	GND		Black

¹⁾ $U_{p'}$ is branched off from different supply voltages, depending on the hardware version:

- From hardware version 03:
 $U_{p'}$ is branched off from the incoming control voltage U_s at [X70](#) [[▶ 28](#)].
- Up to and including hardware version 02:
 $U_{p'}$ is branched off from the incoming peripheral voltage U_p at [X70](#) [[▶ 28](#)].

²⁾ Up to and including hardware version 02: GND_s is connected to pin 3, GND_p to pin 4. Starting with hardware version 03, both pins are connected to the same ground potential GND_s .

Suitable connection cables can be found in the chapter [Accessories](#) [[▶ 89](#)].

4.2.4.3.1 Status LEDs

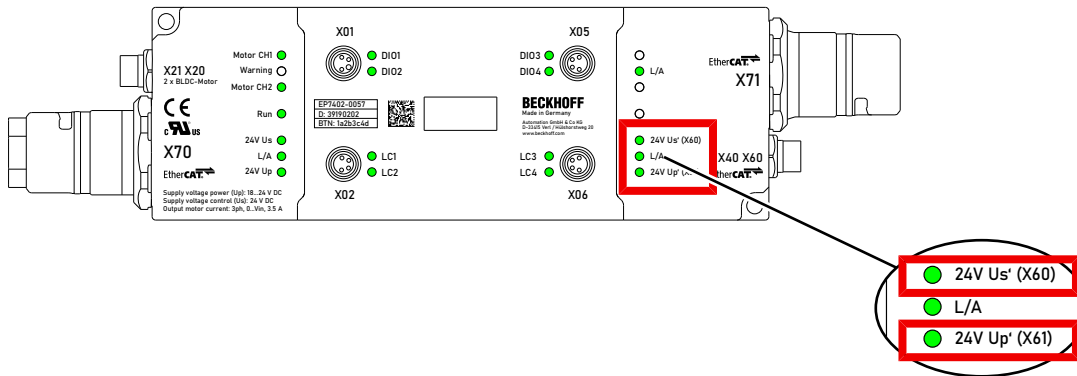

LED	Signal	Meaning
24V Us' (X60)	off	The supply voltage U_S' is not output.
	green illuminated	The supply voltage U_S' is output.
24V Up' (X60)	off	The supply voltage U_P' is not output.
	green illuminated	The supply voltage U_P' is output.

4.2.5 Motor connections of EP7402-0057

4.2.5.1 Pin assignment

X20 and X21

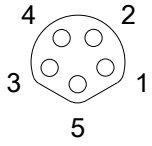
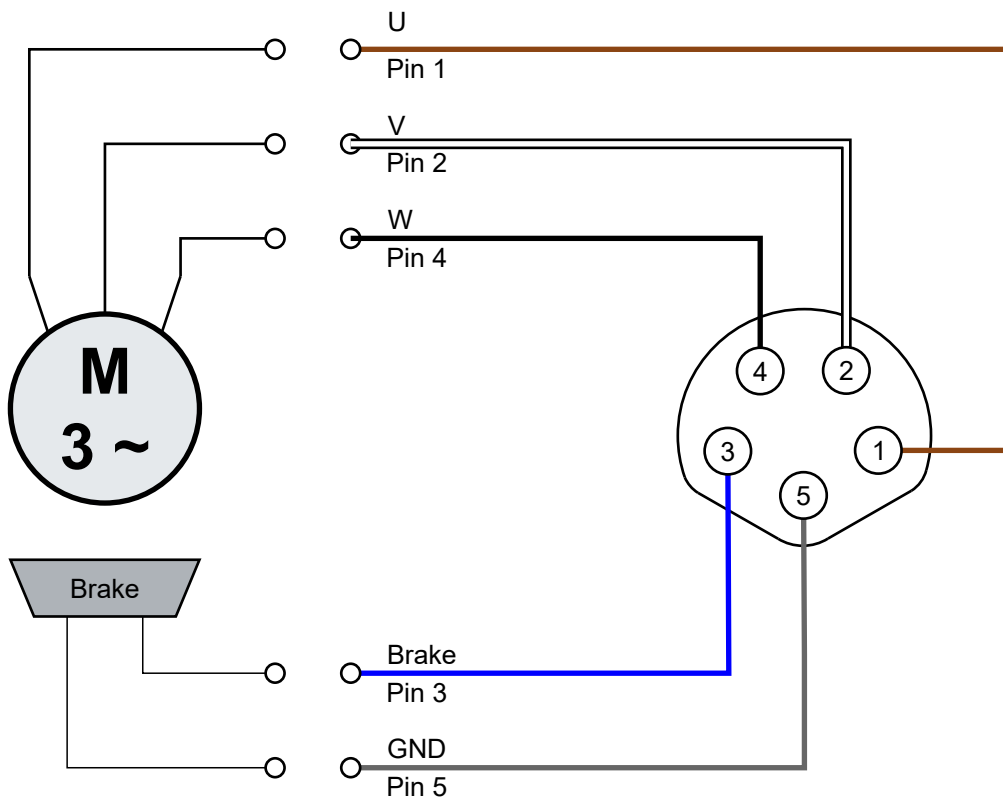

Fig. 3: M8 socket, b-coded

Pin	Wire color	Function
1	brown	Motor phase U
2	white	Motor phase V
3	blue	Brake output
4	black	Motor phase W
5	grey	GND _P

4.2.5.2 Connection example



4.2.5.3 Status LEDs

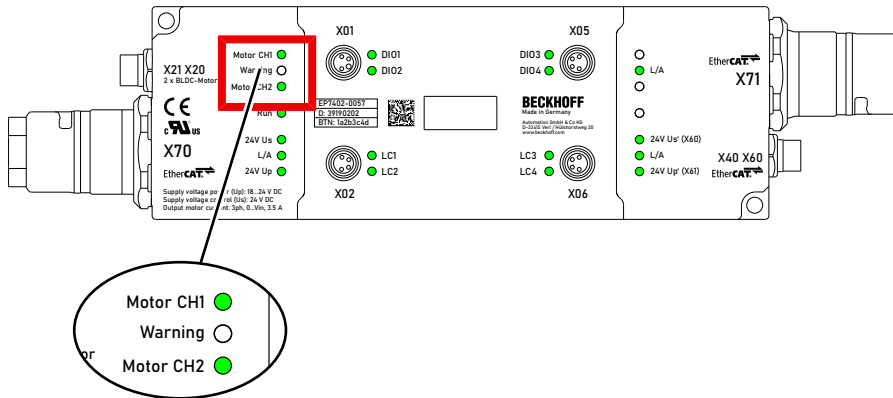

LED	Signal	Meaning
Motor CH1	off	Motor channel 1 is disabled. You can enable it by setting "Enable" to 1 in the process data object STM Control Channel 1 [▶ 17].
	green illuminated	Motor channel 1 is enabled.
	red illuminated	Motor channel 1 has been blocked due to an error. Check the diagnostic bits [▶ 72] to determine the cause of the error.
Warning	orange illuminated	Warning message. Check the diagnostic bits [▶ 72] to determine the cause of the warning message.
Motor CH2	off	Motor channel 2 is disabled. You can enable it by setting "Enable" to 1 in the process data object STM Control Channel 2 [▶ 17].
	green illuminated	Motor channel 2 is enabled.
	red illuminated	Motor channel 2 has been blocked due to an error. Check the diagnostic bits [▶ 72] to determine the cause of the error.

4.2.6 Motor connections of EP7402-0167

4.2.6.1 Pin assignment

M8 sockets X20 and X21

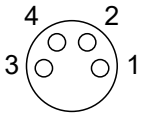

Pin	Wire color	Function
1	brown	Motor phase V
2	white	Motor phase W
3	blue	GND _P
4	black	Motor phase U

4.2.6.2 Connection example

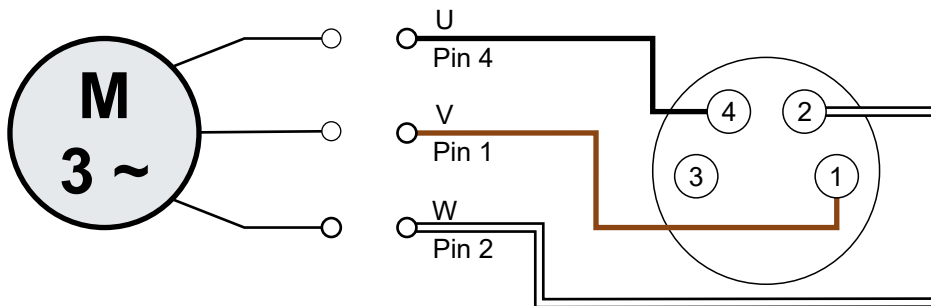

4.2.6.3 Status LEDs

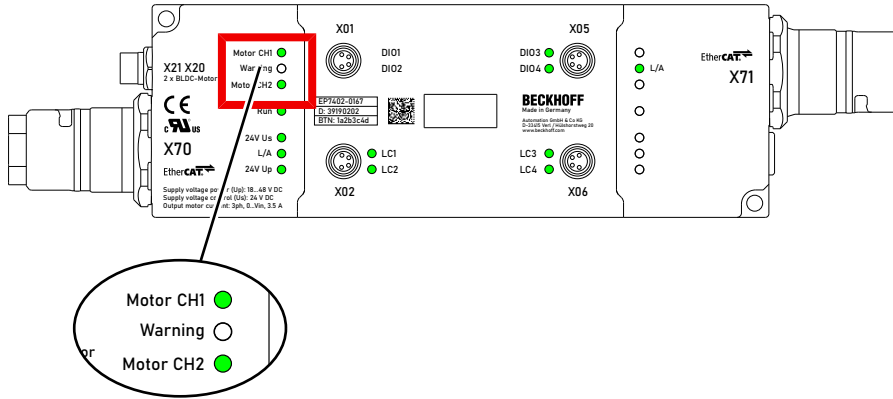

LED	Signal	Meaning
Motor CH1	off	Motor channel 1 is disabled. You can enable it by setting "Enable" to 1 in the process data object STM Control Channel 1 [▶ 17].
	green illuminated	Motor channel 1 is enabled.
	red illuminated	Motor channel 1 has been blocked due to an error. Check the diagnostic bits [▶ 72] to determine the cause of the error.
Warning	orange illuminated	Warning message. Check the diagnostic bits [▶ 72] to determine the cause of the warning message.
Motor CH2	off	Motor channel 2 is disabled. You can enable it by setting "Enable" to 1 in the process data object STM Control Channel 2 [▶ 17].
	green illuminated	Motor channel 2 is enabled.
	red illuminated	Motor channel 2 has been blocked due to an error. Check the diagnostic bits [▶ 72] to determine the cause of the error.

4.2.7 Digital input/outputs

Each channel can be operated either as a digital input or as a digital output.

M8 sockets X01, X02, X05, X06

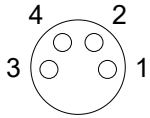

Pin	Core color ¹⁾	Function	Designation in ZPA operation			
			X01	X02	X05	X06
1	brown	U_{S1} : 24 V _{DC} output	-	-	-	-
2	white	Input B / output B ²⁾	Input 2 / Output 2	Control Input 2 / Control Output 2	Input 4 / Output 4	Control Input 4 / Control Output 4
3	blue	GND _S	-	-	-	-
4	black	Input A / output A ²⁾	Input 1 / Output 1	Control Input 1 / Control Output 1	Input 3 / Output 3	Control Input 3 / Control Output 3

¹⁾ The core colors apply to cables of the type ZK2000-3xxx. See chapter [Accessories](#) [► 89].

²⁾ See [Assignment to process data](#) [► 18].

4.2.7.1 Connection examples

Digital sensor, 2-wire connection to channel A

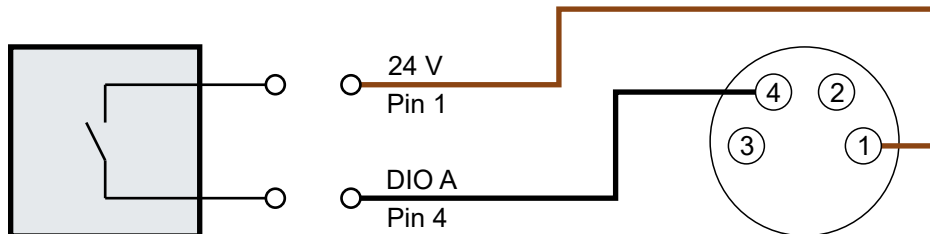

Fig. 4: Digital sensor, 2-wire connection

Digital sensor, 3-wire connection to channel A

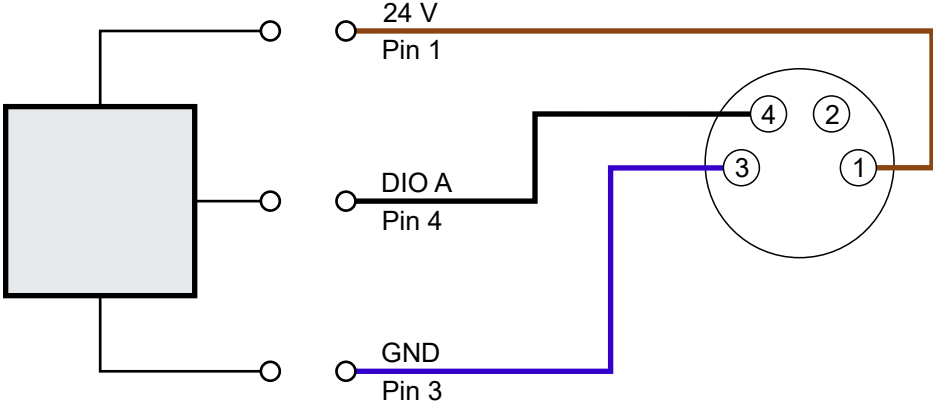

Fig. 5: Digital sensor, 3-wire connection

4.3 UL Requirements

The installation of the EtherCAT Box Modules certified by UL has to meet the following requirements.

Supply voltage

⚠ CAUTION

CAUTION!

This UL requirements are valid for all supply voltages of all marked EtherCAT Box Modules!
For the compliance of the UL requirements the EtherCAT Box Modules should only be supplied

- by a 24 V_{DC} supply voltage, supplied by an isolating source and protected by means of a fuse (in accordance with UL248), rated maximum 4 Amp, or
- by a 24 V_{DC} power source, that has to satisfy *NEC class 2*.
A *NEC class 2* power supply shall not be connected in series or parallel with another (class 2) power source!

⚠ CAUTION

CAUTION!

To meet the UL requirements, the EtherCAT Box Modules must not be connected to unlimited power sources!

Networks

⚠ CAUTION

CAUTION!

To meet the UL requirements, EtherCAT Box Modules must not be connected to telecommunication networks!

Ambient temperature range

⚠ CAUTION

CAUTION!

To meet the UL requirements, EtherCAT Box Modules has to be operated only at an ambient temperature range of -25 °C to +55 °C!

Marking for UL

All EtherCAT Box Modules certified by UL (Underwriters Laboratories) are marked with the following label.



Fig. 6: UL label

4.4 Disposal



Products marked with a crossed-out wheeled bin shall not be discarded with the normal waste stream. The device is considered as waste electrical and electronic equipment. The national regulations for the disposal of waste electrical and electronic equipment must be observed.

5 Commissioning

5.1 Quick start

This chapter describes the commissioning using EP7402-0057 as an example. However, it is equally valid for EP7402-0167.

5.1.1 Step 1: Hardware Setup

1. Connect a roller motor to socket X20. The pin assignment can be found in the chapter [Motor connections of EP7402-0057](#) [▶ 34].

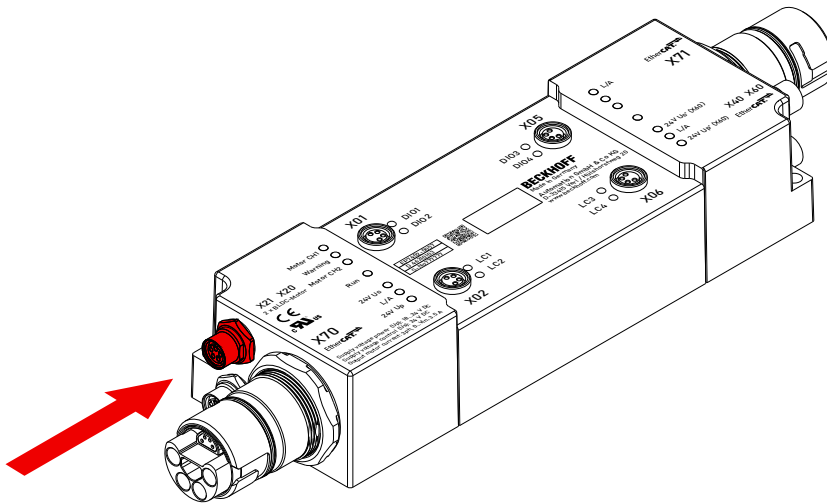

2. Connect the supply voltages and EtherCAT to socket X70. The pin assignment can be found in the chapter [Supply voltages and EtherCAT](#) [▶ 28].

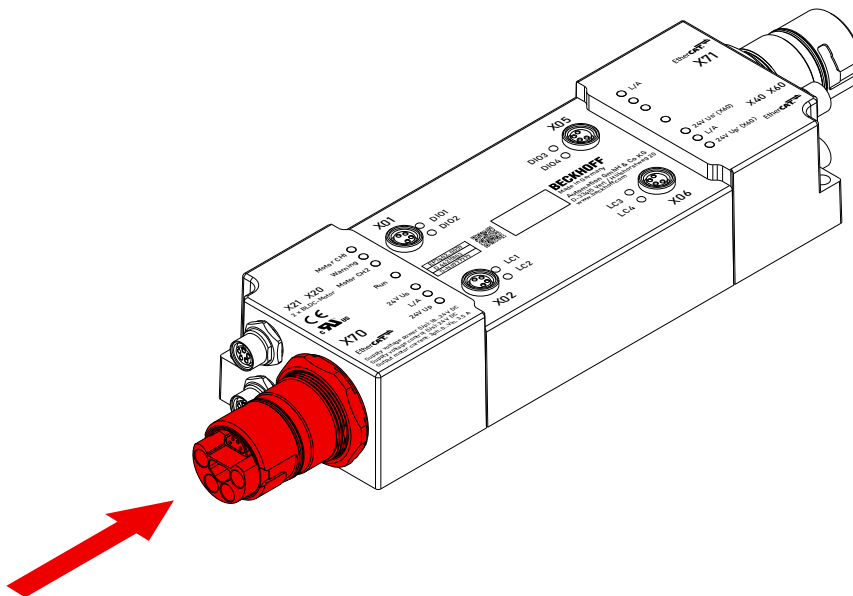

3. Check the correct connection using the status LEDs:

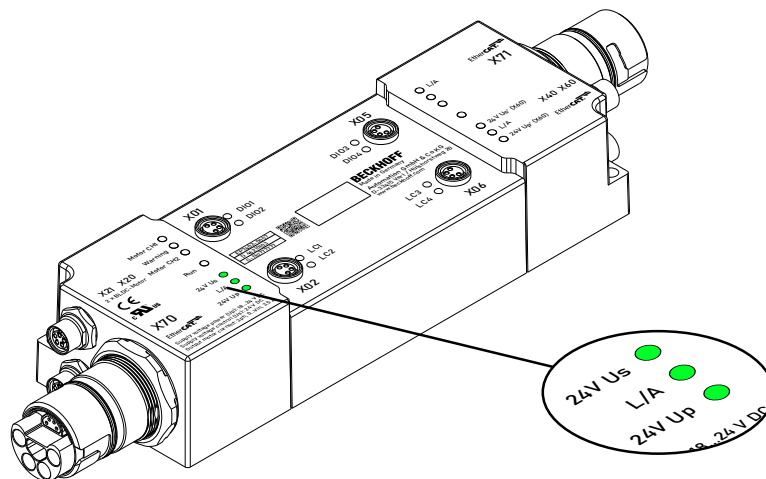

Target state:

- "24V Us" lights up green.
- "24V Up" lights up green.
- "L/A" shows the LINK/ACT status of the EtherCAT communication.

5.1.2 Step 2: TwinCAT configuration

1. Integrating EP7402-0057 into a TwinCAT project. (see [quick start guide](#))

⇒ For firmware versions up to and including 02, a dialog box appears:

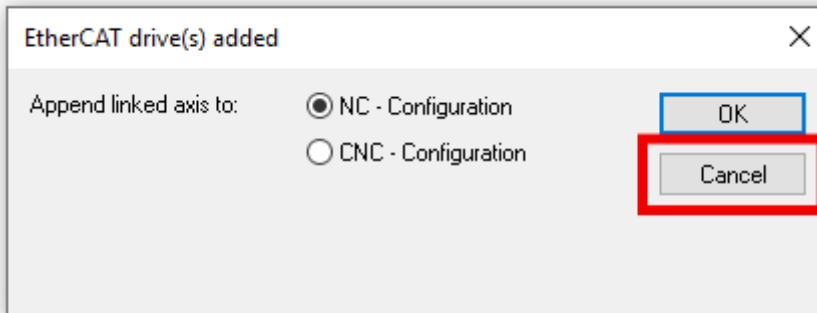

Click on "Cancel" to close the dialog box.

2. Reset EP7402-0057 to factory settings:

Set parameter 1011:01 to value 1684107116_{dec}.

Index	Name	Flags	Value	Unit
1000	Device type	RO	0x00001389 (5001)	
1008	Device name	RO	EP7402-0057	
1009	Hardware version	RO		
100A	Software version	RO		
100B	Bootloader version	RO		
1011:0	Restore default parameters	RO	> 1 <	
1011:01	SubIndex 001	RW	0x64616F60 (1684107116)	
1018:0	Identity	RO	> 4 <	
10E2:0	Manufacturer-specific Identification C...	RO	> 1 <	
10F0:0	Backup parameter handling	RO	> 1 <	
1600:0	DO RxPDO-Map Outputs	RO	> 9 <	
1601:0	STM RxPDO-Map Control Ch.1	RO	> 7 <	
1602:0	STM RxPDO-Map Target Velocity Ch.1	RO	> 3 <	
1603:0	STM RxPDO-Map Control Ch.2	RO	> 7 <	
1604:0	STM RxPDO-Map Target Velocity Ch.2	RO	> 3 <	

For more information see chapter [Restore the delivery state](#) [▶ 70].

5.1.3 Step 3: parameterization



Example parameters for a servomotor from Beckhoff:

[AM8111-0F20-0000](#) [▶ 87]

5.1.3.1 Setting the motor parameters

Procedure:

1. Open the "CoE - Online" tab.
2. Set all parameters described below.
Leave all parameters not described in the factory setting.

The values for the parameters can be found in the motor data sheet.

Index	Name	Flags	Value	Unit
7020:0	STM Outputs Ch.1	RO	> 35 <	
7030:0	STM Outputs Ch.2	RO	> 35 <	
8020:0	STM Motor Settings Ch.1	RW	> 25 <	
8020:01	Peak current	RW	0x03E8 (1000)	mA
8020:02	Rated current	RW	0x03E8 (1000)	mA
8020:03	Rated voltage	RW	0x0960 (2400)	0.01 V
8020:04	Phase to phase resistance	RW	0x0064 (100)	0.01 Ohm
8020:09	Start velocity	RW	0x0BB8 (3000)	%/s
8020:13	Mechanical to electrical ratio	RW	0x0001 (1)	
8020:14	Rated velocity	RW	0x1388 (5000)	%/s
8020:16	I2T warn level	RW	0x50 (80)	%
8020:18	I2T error level	RW	0x6E (110)	%
8020:19	Motor thermal time constant	RW	0x000F (15)	0.1 s
8023:0	STM Controller Settings 4 Ch.1	RW	> 38 <	
8030:0	STM Motor Settings Ch.2	RW	> 25 <	

8020:01 "Peak current"

Unit: mA

The peak current, which may only flow for a short time.

8020:02 "Rated current"

Unit: mA

The rated current is the current that the motor draws when it is operated at the rated speed and rated torque.

8020:03 "Rated voltage"

Unit: 0.01 V

8020:04 "Phase to phase resistance"

Unit: 0.01 Ω

DC resistance, measured between two motor phases.

Note: from firmware 04, this value is determined automatically when scanning the motor. See next chapter [Scan motor \(only firmware 04 and higher\)](#) [▶ 47].

8020:09 "Start velocity"

Unit: °/s (degrees per second)

There are two ways to calculate the value for this parameter:

- If the nominal velocity of the conveyor roller is known, use this formula:

$$n_{start} = \frac{1}{10} \times \frac{1}{i} \times \frac{v}{\pi \times d} \times 360^\circ$$

n_{start}: Value for parameter 8020:09 "Start velocity"i: Transmission ratio.
(i = 1 if no gear unit is used)v: Nominal velocity in m/s
(Note: v [m/s] = v [fpm] / 196.85)

d: Conveyor roller diameter in m

- If the nominal speed of the roller motor is known, use this formula:

$$n_{start} = \frac{1}{10} \times \frac{n_N}{i} \times \frac{360^\circ}{60 \frac{s}{min}}$$

n_{start}: Value for parameter 8020:09 "Start velocity"n_N: Nominal velocity of the motor in rpmi: Transmission ratio
(i = 1 if no gear unit is used)**8020:13 "Mechanical to electrical ratio"**

You can calculate or experimentally determine the value for this parameter.

- If the number of poles of the roller motor is known, use this formula:

$$p = \frac{\text{number of poles}}{2} \times i$$

p: Value for parameter 8020:13 "Mechanical to electrical ratio"

i: Transmission ratio.
(i = 1 if no gear unit is used)

- Example:

Number of poles = 8

Transmission ratio = 12:1

→ "Mechanical to electrical ratio" = (8 / 2) x 12 = 48

- If the number of poles of the roller motor is not known:

Determine the "Mechanical to electrical ratio" experimentally [► 53].**8020:14 "Rated velocity"**

Unit: °/s

Rated speed of the roller motor.

8020:19 "Motor thermal time constant"

Unit: 1/10 s (1/10 of a second)

5.1.3.2 Scan motor (only firmware 04 and higher)

The following parameters are determined when scanning the motor:

- The winding resistance of the motor: parameter 8020:04 "Phase to phase resistance".
- Controller parameters for the current controller:
 - 8023:23 "Current loop proportional gain"
 - 8023:24 "Current loop integral time"

Executing the scan

- ✓ Requirement: you have conscientiously set all parameters in the previous chapter [Setting the motor parameters \[▶ 45\]](#).
1. Open the "CoE - Online" tab and check the "Auto Update" checkbox.
 2. Write one of the following values into parameter 0xFB00:01 "Request":
 Value 0x8007 for channel 1.
 Value 0x8017 for channel 2.

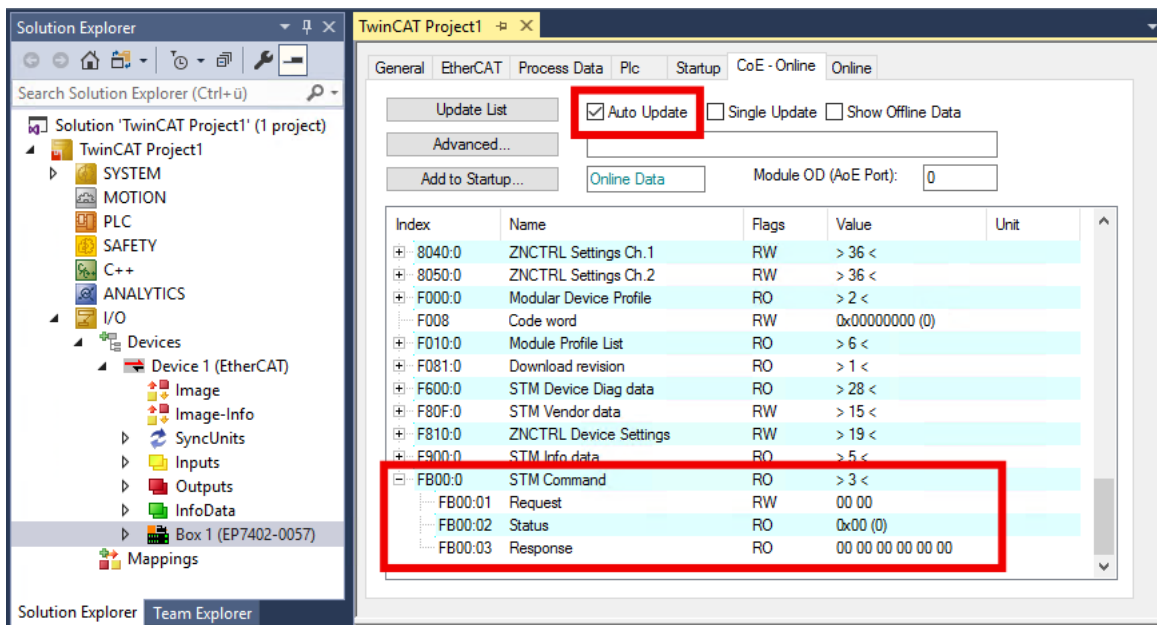

- ⇒ The scan will be executed.
 - ⇒ The value of register FB00:02 "Status" indicates the progress of the scan.
 The values 100_{dec} ... 200_{dec} correspond to 0 ... 100 %.
3. Wait until register FB00:02 "Status" assumes the value 0 or 3.
 - ⇒ Value 0: the scan was successful.
 - ⇒ Value 3: error. See [troubleshooting \[▶ 48\]](#).

Troubleshooting

If an error occurs during the scan, an error code is output in parameter FB00:03 "Response". The following table shows the possible error codes:

Response	Meaning and remedy
03 00 00 00 00 01	Make sure that the following bits of both channels have the correct value: <ul style="list-style-type: none">• PDO "STM Status Channel n", Bit "Ready to enable" = 1• PDO "STM Control Channel n", Bit "Enable" = 0
03 00 00 00 00 02	Make sure that the bit "Ready to enable" has the value 1.
03 00 00 00 00 03	An internal error has occurred. See also diagnostic bit General hardware error.
03 00 00 00 00 04	The scan could not be performed successfully. Check that the motor is connected correctly and that the motor shaft can rotate freely.

An error does not have to be acknowledged. If a scan was aborted with an error message, you can simply start a new scan.

5.1.3.3 Setting the controller parameters

Procedure:

1. Open the "CoE - Online" tab.
2. Set all parameters described below.
Leave all parameters not described in the factory setting.

(Detailed descriptions of the parameters can be found in the chapter [Parameterization objects \[► 81\]](#).)

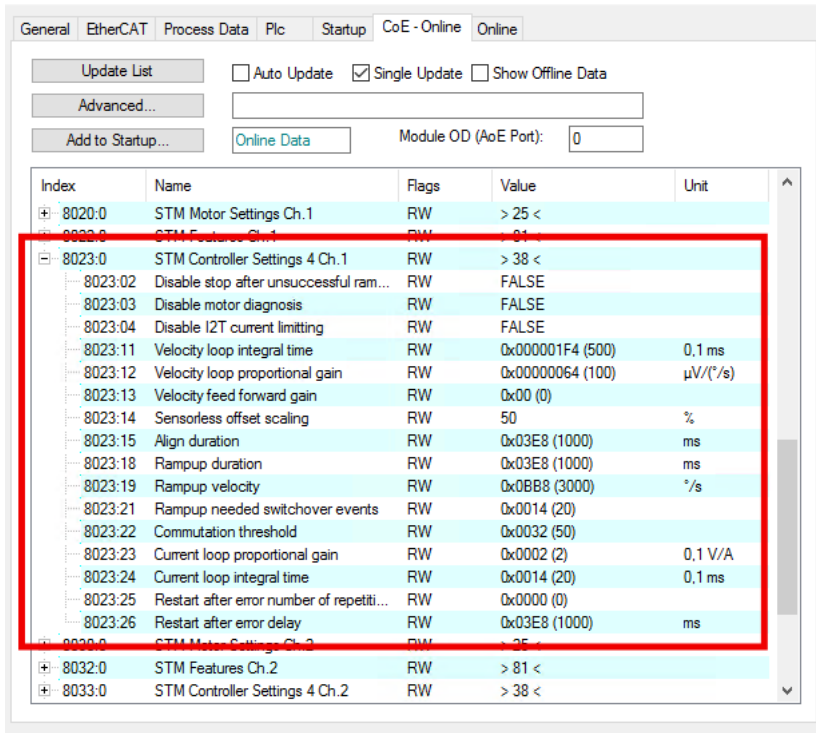

8023:03 “Disable motor diagnosis”

Set this parameter to TRUE. This disables the diagnosis feature during align phase.

8023:12 „Velocity loop proportional gain“

Set this parameter to zero. This disables the velocity controller. Reenable it after [Step 4: Test run \[► 50\]](#) has been successfully completed.

8023:13 “Velocity feed forward”

Set this parameter to 100. This makes the target velocity value bypass the velocity controller.

8023:14 „Sensorless offset scaling“

Set this parameter to 80.

8023:19 “Rampup velocity”

Set this parameter to the same value as parameter 8020:09 “Start velocity”. Unit: °/s (degrees per second).

8023:21 "Rampup needed switchover events"

Set this parameter to 1.

5.1.4 Step 4: Test run

1. Ensure that all previous steps have been completed successfully.
2. Remove any load from the conveyor roller.
3. If the motor has a holding brake, release the holding brake: set "Brake output" to 1.

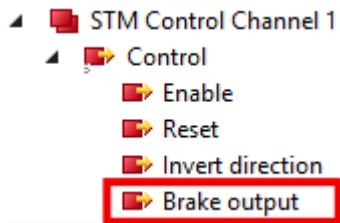

4. Set "Velocity" to 50% of the nominal velocity of the motor including gear unit:

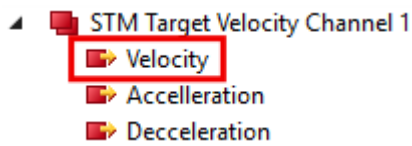

Formula for calculating 50% of the nominal velocity:

$$n = \frac{1}{2} \times \frac{n_N}{i} \times \frac{360^\circ}{60 \frac{s}{min}}$$

n: Value for the "Velocity" output variable

n_N : Nominal velocity of the motor in rpm

i: Transmission ratio. (i = 1 if no gear unit is used)

5. Set "Enable" to 1.

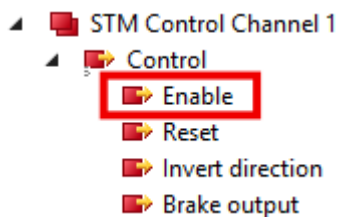

- ⇒ The rotor is aligned for 1 second.
- ⇒ The box then attempts to turn the motor.

6. Assess the result. [▶ 51]

Possible results of the test run

- If the motor rotates continuously: skip to [next step \[► 52\]](#) of commissioning.
- If the motor does not rotate continuously:
 - Set the output variable "Enable" to 0
 - Check the status bits in the input variable "Device Diag".
 - Evaluate the status bits with the help of the table below.
 - Set the output variable "Reset" to 1. (this resets the status bits)
 - Set the output variable "Reset" to 0.
 - Repeat the test run: to do this, set the output variable "Enable" to 1.

Set bit in "Device Diag"	Possible reasons	Solution
(none)	The output variable "Velocity" is smaller than the parameter 8020:09 "start velocity".	Check the calculations.
"Channel 1 motor overload I2T error"	The output current is too high.	Reduce the value of parameter 8023:14 "Sensorless offset scaling".
"Channel 1 commutation error"	The conveyor roller is loaded ¹⁾	Remove any load from the conveyor roller.
	The output current is too low.	Increase the value of parameter 8023:14 "Sensorless offset scaling" [► 81] .
	"Rampup velocity" is too high ¹⁾	Check the calculation of the parameter 8023:19 "Rampup velocity" [► 49] . If the calculation is correct, reduce the value of this parameter.
	"Rampup needed switchover events" is too low.	Increase the value of parameter 8023:21 "Rampup needed switchover events" [► 49] .
	Incorrect motor parameters	Check the motor parameters
	The motor is too weak ¹⁾	Insert a gear unit and recalculate all parameters.

¹⁾ Especially likely when the motor makes a sound with ascending pitch.

5.1.5 Step 5: Final steps

1. Set "Enable" to 0.

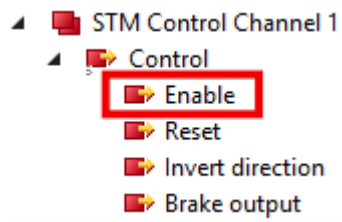

2. Set parameter 8023:12 "Velocity loop proportional gain" to 100_{dec}.
(Any value above zero activates the velocity controller)
⇒ You can now control the motor with the variables "Enable" and "Velocity".
3. During operation, monitor the [diagnostic bits \[► 72\]](#).
4. [Fine-tuning of the parameters \[► 54\]](#)

5.2 Determining the “Mechanical to electrical ratio” experimentally

The parameter 8020:13 "Mechanical to electrical ratio" is a central parameter for the operation of the EP7402. You can calculate this parameter, if the number of poles and the transmission ratio are known. Otherwise you have to determine the parameter experimentally. The procedure depends on the firmware version:

5.2.1 Firmware 04 and higher

The principle for experimentally determining the "Mechanical to electrical ratio" is to make the motor perform one complete revolution step by step, counting the steps.

To do this, proceed as follows:

1. Ensure that the motor shaft can move freely.
2. Set "Velocity" to 0.
3. Ensure that the channel is ready ("Ready to enable" = 1).
4. Set "Enable" to 1.
 - ⇒ One of the motor phases is powered.
 - ⇒ You may hear a clicking noise from the roller motor.
5. Write one of the following values into parameter 0xFB00:01 "Request":
 - Value 0x800A for channel 1.
 - Value 0x801A for channel 2.
 - ⇒ The motor on the corresponding channel turns one step forward.
6. Read the register FB00:02 "Response".
 - ⇒ Byte 0 = 0: no error. Continue.
 - ⇒ Byte 0 = 2: error. Check diagnostic bits. See chapter [Diagnosis bits \[► 72\]](#).
7. Repeat steps 5 and 6 several times until the motor has completed exactly one revolution. While doing so, count the number of steps. ¹⁾
8. Set "Enable" to 0.
9. Divide the number of steps by 6 and enter the result in parameter 8020:13 "Mechanical to electrical ratio".

¹⁾ Hint: If you are not sure when the motor has completed a full revolution (e.g. due to backlash in the gear unit), you can allow the motor to rotate for two or more revolutions. Then divide the counted steps by the number of revolutions.

5.2.2 Firmware 03 and lower

1. Set the parameter 8023:03 "Disable motor diagnosis" to TRUE.
2. Set "Velocity" to 0.
3. Set "Enable" to 1.
 - ⇒ A motor phase is powered.
 - ⇒ You may hear a "click" noise from the roller motor.
4. Rotate the conveyor roller by hand. Do you feel defined snap steps?
 - Yes: continue below
 - No: increase the value of parameter 8023:14 "Sensorless offset voltage" by 10_{dec} and try again.
5. Turn the conveyor roller 360° by hand. Count the number of snap steps. ¹⁾
6. Set "Enable" to 0.
7. Set the parameter 8023:03 "Disable motor diagnosis" back to FALSE.
8. Enter the number of snap steps in parameter 8020:13 "Mechanical to electrical ratio".

¹⁾ Hint: make a mark on the roller. This makes it easier to rotate the roller by exactly 360°.

5.3 Fine-tuning parameters

5.3.1 Alignment phase and ramp-up phase

Use the following diagram to adjust the parameters of the alignment phase and the ramp-up phase. The CoE indexes of the parameters are shown in the diagram. n is the number of the motor channel.

Best practice for tuning a parameter:

1. Set the output variable "Enable" to 0
2. Adjust the desired parameter
3. Set the output variable "Enable" to 1
4. - Evaluate the result
 - Check the [Diagnosis bits](#) [► 72] for warnings or errors
 - Try again if necessary.

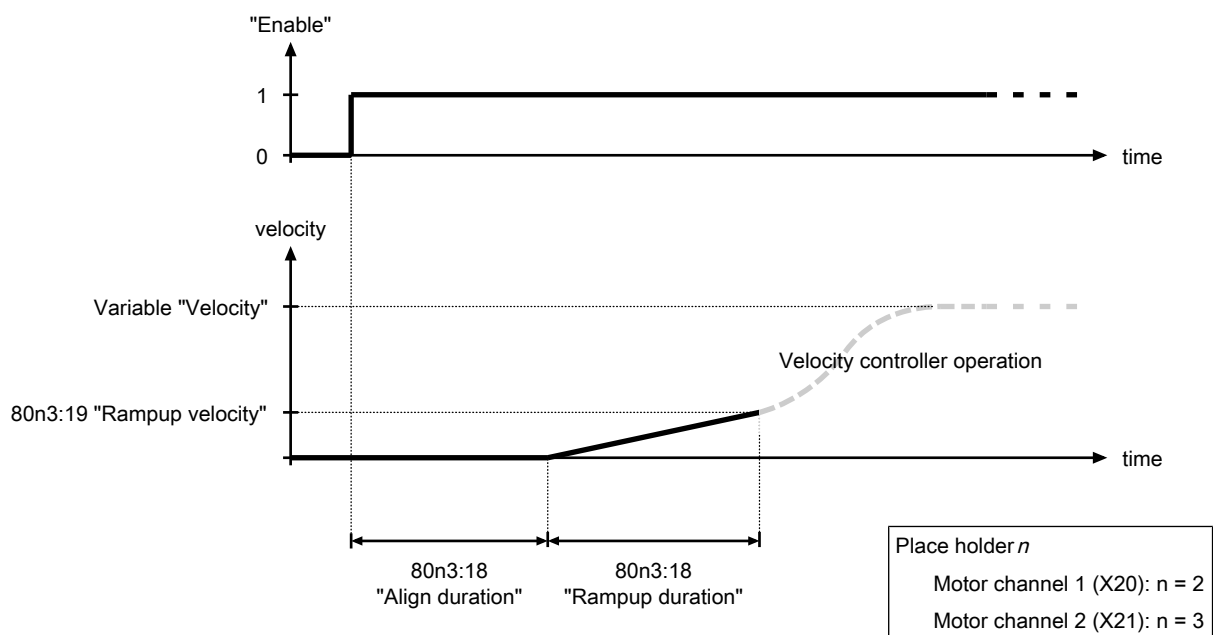

Fig. 7: Alignment phase and ramp-up phase parameters

5.3.2 Velocity controller

The velocity controller is a PI controller. The controller parameters are located in the CoE directory:

- Proportional gain K_p : parameter $80n3:11_{hex}$ "Velocity loop integral time"
- Integral time T_i : CoE parameter $80n3:12_{hex}$ "Velocity loop proportional gain"
- Parameter $80n3:13_{hex}$ "Feed forward gain"

You can disable the velocity controller by setting the proportional gain K_p to zero.

5.4 Autoacknowledge: acknowledge errors automatically



This function is available from firmware 05.

If a commutation error occurs, the motor channel affected is disabled. The Autoacknowledge function can automatically re-enable the motor channel and restart the motor.

Autoacknowledge works both in operation with a central PLC and in ZPA mode.

Delivery state

In the delivery state, the Autoacknowledge function is disabled. To enable it, set parameter F810:14 "Autoacknowledge number of attempts" to a value greater than 0. See chapter [Configuration of Autoacknowledge](#) [▶ 55].

5.4.1 Configuration of Autoacknowledge

There are two parameters with which you can configure the Autoacknowledge function:

Maximum number of errors that are automatically acknowledged

With the parameter F810:14 "Autoacknowledge number of attempts" you define the maximum number of commutation errors that are to be automatically acknowledged by the Autoacknowledge function. If this number is exceeded, the motor channel goes into an error state that must be acknowledged manually. See chapter [Acknowledging errors](#) [▶ 74].

If this parameter has the value 0, the Autoacknowledge function is disabled for the corresponding motor channel.

Delay time after error

With the parameter F810:15 "Autoacknowledge delay" you define the timespan between the occurrence of a commutation error and the automatic acknowledgement of the error. Unit: milliseconds.

5.4.2 Reading the state

Number of acknowledged errors

Parameter 9040:01 "Autoacknowledge current number of attempts" contains the number of commutation errors that have been acknowledged since the last manual acknowledgement or power-up of the box.

Elapsed time since last Autoacknowledge

Parameter 9040:02 "Autoacknowledge current waiting time" contains the time in milliseconds that has elapsed since the last autoacknowledge event.

5.5 ZPA: Zero Pressure Accumulation

This chapter describes the configuration of an EP7402 for autonomous operation with "Zero Pressure Accumulation" (ZPA).

5.5.1 Requirements

Software

- Firmware version 03 or higher
- ESI version 0020 or higher

Hardware

- One EP7402 for every two zones
- One sensor per zone

5.5.2 Basic principles

ZPA is a strategy for controlling the transport of goods on a roller conveyor. ZPA is characterized by two key aspects:

- Avoidance of collisions between the conveyed goods.
- Autonomous operation of the motor controller. A central control system is not required.

5.5.2.1 Glossary

In the environment of roller conveyors with ZPA operation, some terms have become established. The terms are also used in this documentation:

Term	Meaning
Downstream	Direction indication: in conveying direction
MDR	Abbreviation for "Motor Driven Roller" (roller motor)
Singulated release	See chapter Release types [► 58].
Train release	See chapter Release types [► 58].
Upstream	Direction indication: against the conveying direction
Zone	A section of a roller conveyor.
ZPA	Abbreviation for "Zero Pressure Accumulation".

5.5.2.2 Functioning

A roller conveyor is divided into zones for operation with ZPA. Each zone has a roller motor as a drive and a sensor that determines whether there is material in the zone. A motor controller controls the roller motor and evaluates the information from the sensor.



An EP7402 contains two motor controllers. Thus, only one EP7402 is required to control two zones.

A package is only forwarded from one zone to the following zone if there is no package in the following zone or if the existing package is already forwarded. To make this possible, the motor controllers of adjacent zones communicate with each other.

Example

This example shows the behavior of the motor controllers of two adjacent zones. The two zones can be located at any position within a roller conveyor. The figures show a view from above.

1. Initial situation:

Zone A accepts a package from the previous zone.

Zone B contains a package that is currently not being conveyed any further. This may be due, for example, to the fact that there is also a package in the following zone.

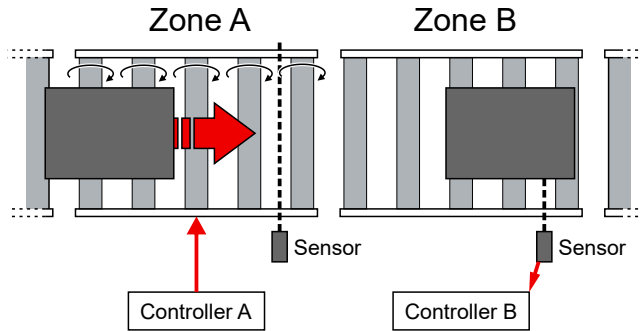

2. As soon as the sensor of zone A detects the package, controller A stops the motor. He is now waiting for zone B to become free.

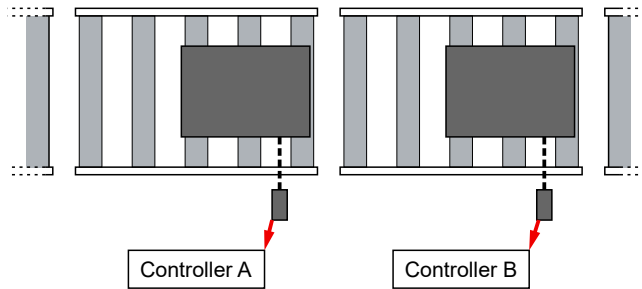

3. The material has been removed from zone B, e.g. by continuing to convey it or by removing it manually.

Controller B reports to controller A that zone B is free.

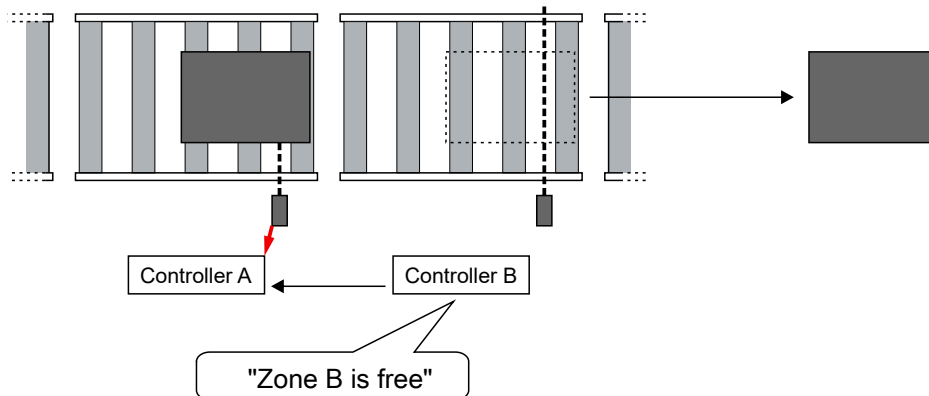

4. Controller A notifies Controller B that it is conveying a package to Zone B. Both controllers start their motors to convey the package further.

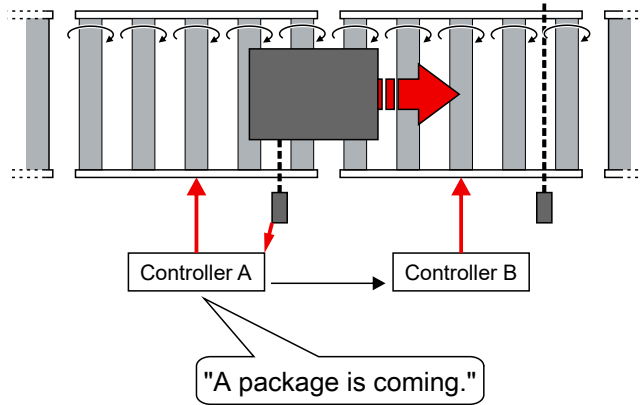

5.5.2.3 Release types

The release type determines the time from which a zone is assumed to be "free" for subsequent packages.

- With singulated release a zone is only assumed to be "free" when the package currently in the zone has left the detection range of the sensor.
- With train release a zone is assumed to be "free" as soon as the package currently in the zone is conveyed further.

Train release enables higher throughput.

5.5.2.4 ZPA operation with EP7402

An EP7402 contains two motor controllers. Thus, only one EP7402 is required to control two zones.

ZPA communication

In ZPA mode, communication is required between the motor controllers of adjacent zones.

The internal ZPA communication between the two motor controllers within an EP7402 is done via internal variables.

The external ZPA communication between the motor controllers of two adjacent EP7402 is optionally performed by one of the following mechanisms:

- Switching signals of the digital inputs/outputs (X01, X02, X05, X06) via M8 cables. (factory setting)

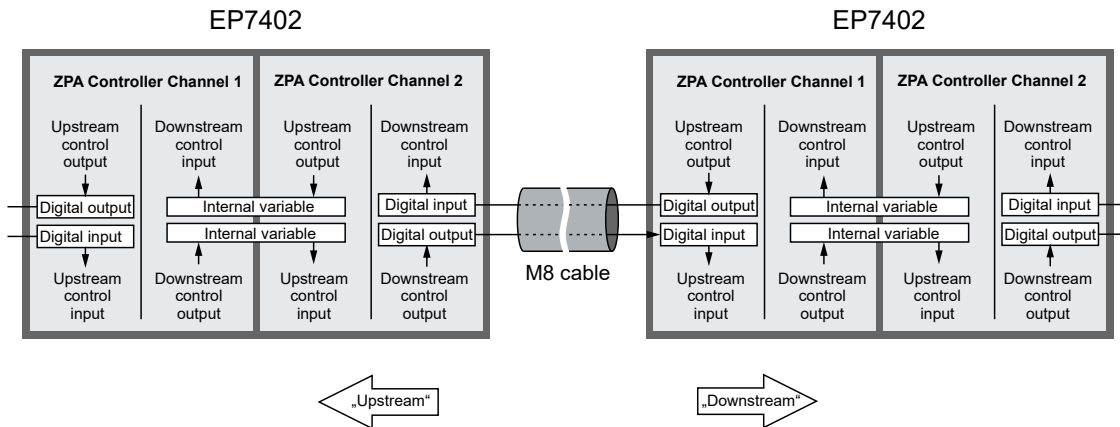

- EtherCAT communication via a controller.

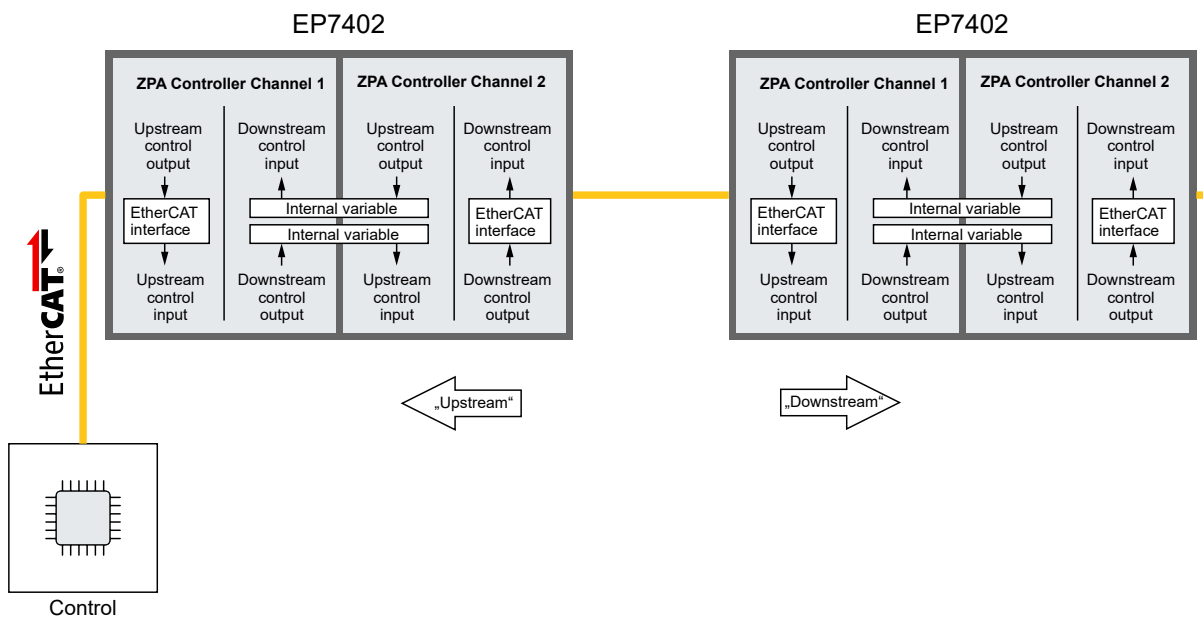

See chapter [ZPA communication via EtherCAT](#) [▶ 62].

5.5.3 Cabling

The following figure shows the start of a roller conveyor.

Wire the EP7402 as shown in the figure.

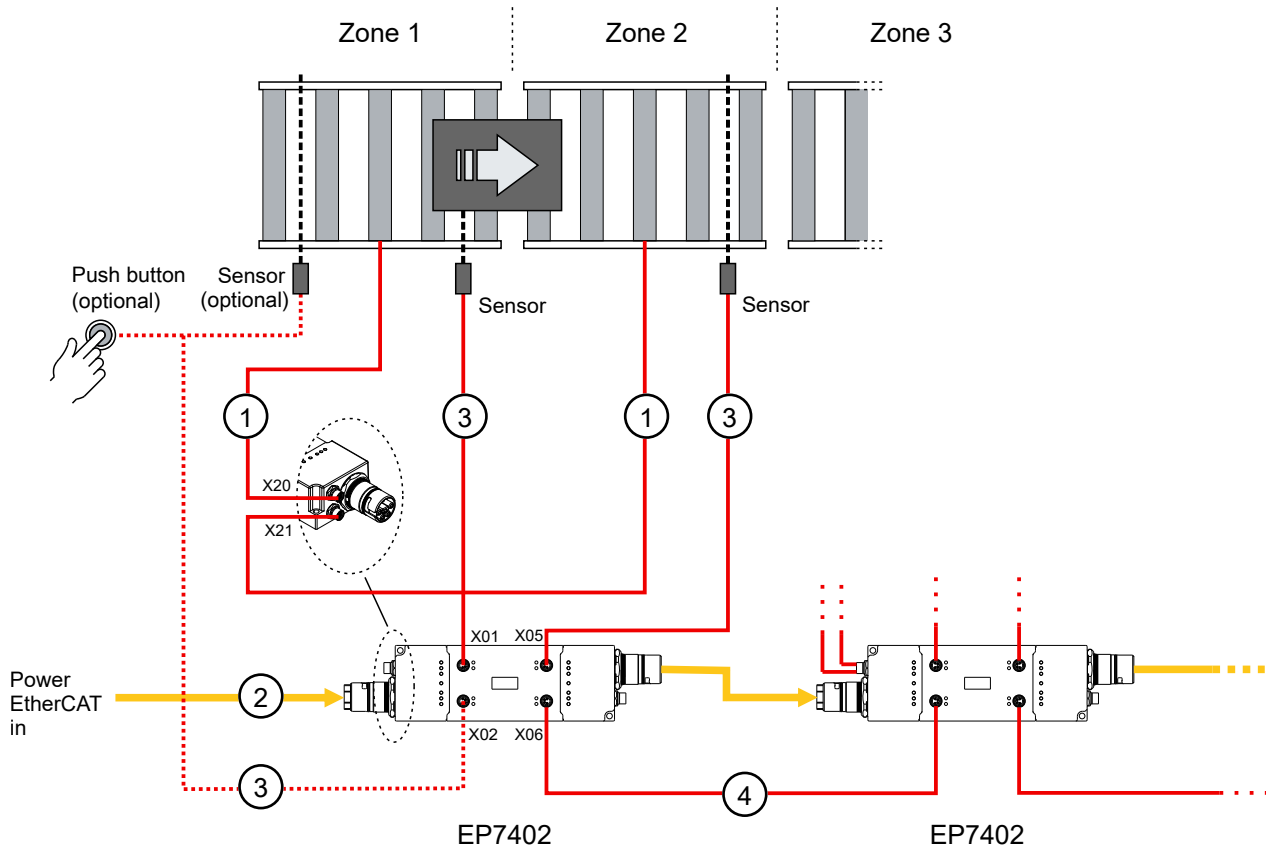

Cables

No.	Type	Number per zone	Function
1	Motor cable	2	Connection of MDR
2	Hybrid cable B23 ENP	1	Connection of EtherCAT and supply voltages
3	Sensor cable M8, 4-pin	2	Connecting the sensors
4		1	ZPA communication with the adjacent EP7402. ¹⁾

¹⁾ This cable is omitted if the ZPA communication is done via EtherCAT, see chapter [ZPA communication via EtherCAT](#) [► 62].

All required cables are available from Beckhoff. See chapter [Accessories](#) [► 89].

The pin assignment can be found in the chapter [Cabling](#) [► 25].

The first zone: Zone 1

In principle, you can set up and wire the first zone in the same way as all other zones. The conveying process starts as soon as a package is placed in the detection range of the sensor.

However, since the feeding of packages takes place at the *beginning* of zone 1 and the sensor is usually at the *end* of the zone, it may make sense to use an additional sensor or push button at the beginning of zone 1. The additional sensor or push button is shown as "optional" in the figure.

Connect the signal of the sensor or push button to pin 4 of X02 of the first EP7402. The pin assignment can be found in the chapter [Digital input/outputs \[► 38\]](#).

The last zone

In the factory setting of EP7402, the conveying process stops as soon as a package reaches the detection range of the sensor of the last zone.

The wiring and configuration of the last zone depends on whether the last zone is connected to channel 1 or channel 2 of an EP7402.

- Channel 1:
Disable channel 2 by setting parameter 8050:01_{hex} "Disable zone" to TRUE.
- Channel 2:
Leave the X06 connection of the last EP7402 unconnected.

Sensor signals

With the factory settings, the EP7402 expects a digital Hi level when a sensor detects a package.

If you are using sensors that provide a low-active signal, change the following parameters:

- Channel 1: Change the value of parameter 8040:13_{hex} from "Input 1" to "Input 1 [low active]".
- Channel 2: Change the value of parameter 8050:13_{hex} from "Input 3" to "Input 3 [low active]".

5.5.4 ZPA communication via EtherCAT

In the factory setting of the EP7402, ZPA communication with adjacent EP7402 takes place by means of digital switching signals via M8 cables.

This chapter describes how to configure an EP7402 so that ZPA communication takes place via EtherCAT instead.

1 Digital inputs and outputs become available

If the ZPA communication is done via EtherCAT, you can use the digital inputs and outputs that were originally used for the ZPA communication for other purposes. See chapter Digital inputs and outputs in ZPA mode [▶ 68].

Setting the parameters

Set the following parameters in the CoE directory:

Parameter		Value	
8040:14	"Upstream control input hardware selection"	144 _{dec}	"PDO value"
8040:15	"Upstream control output hardware selection"	0	"None"
8050:16	"Downstream control input hardware selection"	144 _{dec}	"PDO value"
8050:17	"Downstream control output hardware selection"	0	"None"

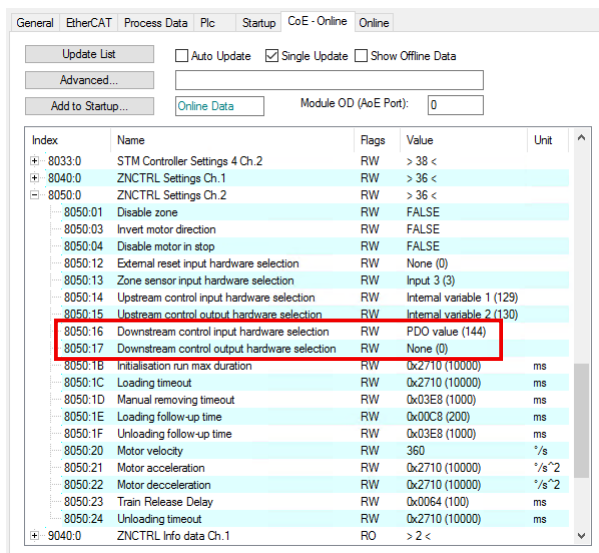
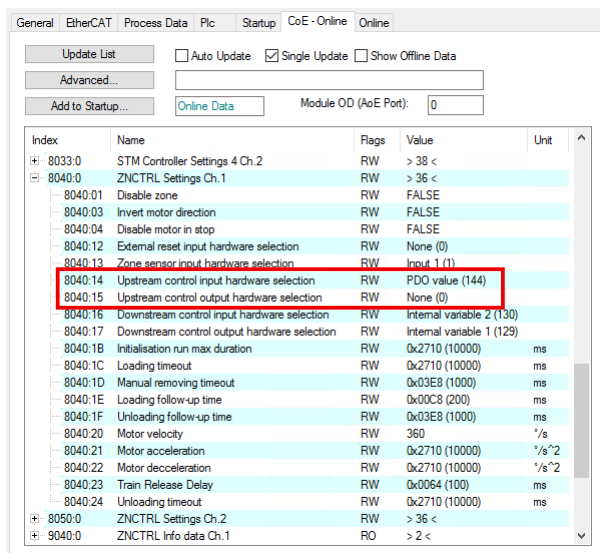

Linking variables

In the controller, link the following variables between *all* adjacent EP7402:

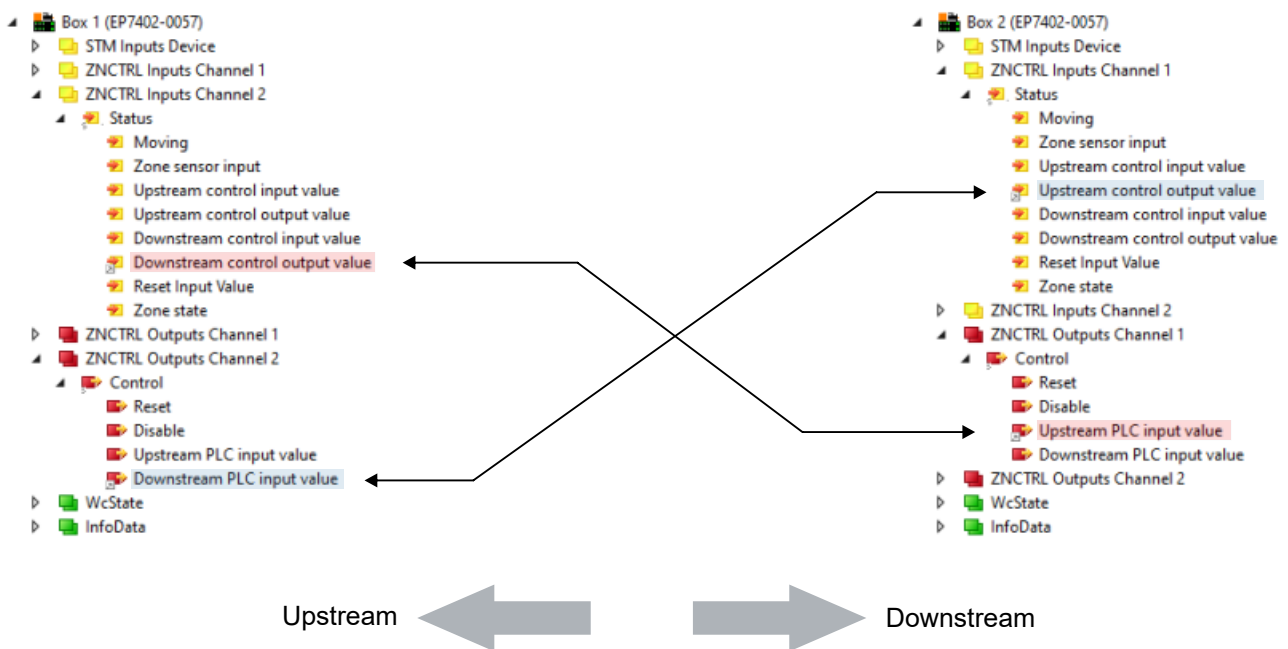

i Linking the variables directly

To link two variables directly in TwinCAT, proceed as follows:

- Right-click a variable and select "Change Link..." from the context menu.
- In the dialog box, uncheck "Exclude same Image".

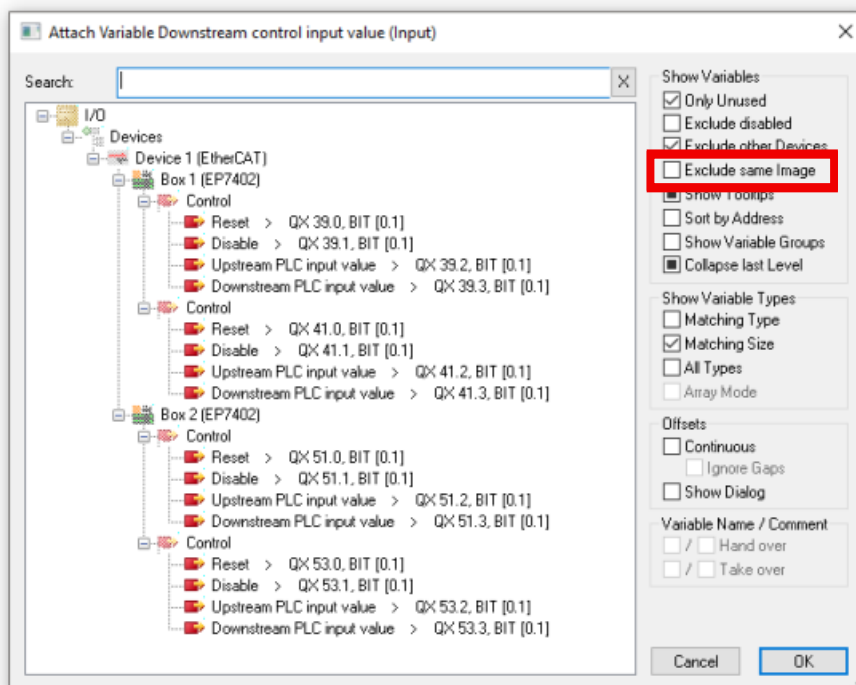

⇒ The variables of the EtherCAT junction become visible.

- Select variable and click "OK".

5.5.5 Commissioning

⚠ CAUTION

The motor rotates during startup
 Injuries and property damage are possible.

- Make sure that the motor can move freely at all times and that it cannot cause injury or damage.

1. Configure both motor channels as described in chapter [Quick start](#) [▶ 42].
2. Activate the ZPA process image by selecting the Predefined PDO Assignment "Local control".

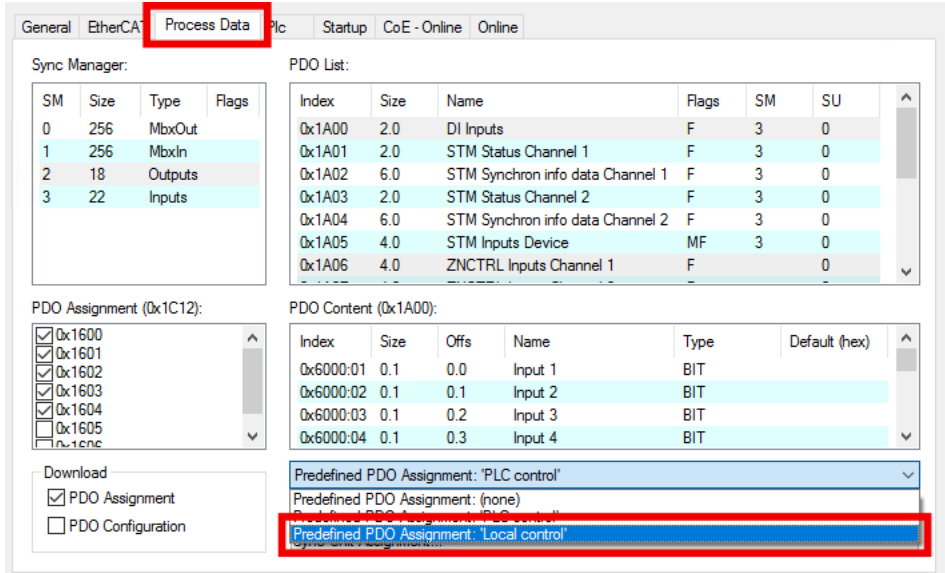

3. Configure ZPA communication:
 - If the ZPA communication is to be done via M8 cables, skip this step.
 - If the ZPA communication is to take place via EtherCAT, see chapter [ZPA communication via EtherCAT](#) [▶ 62].
4. Activate the ZPA mode by setting the CoE parameter F810:11 "Operation mode" to "Local control".

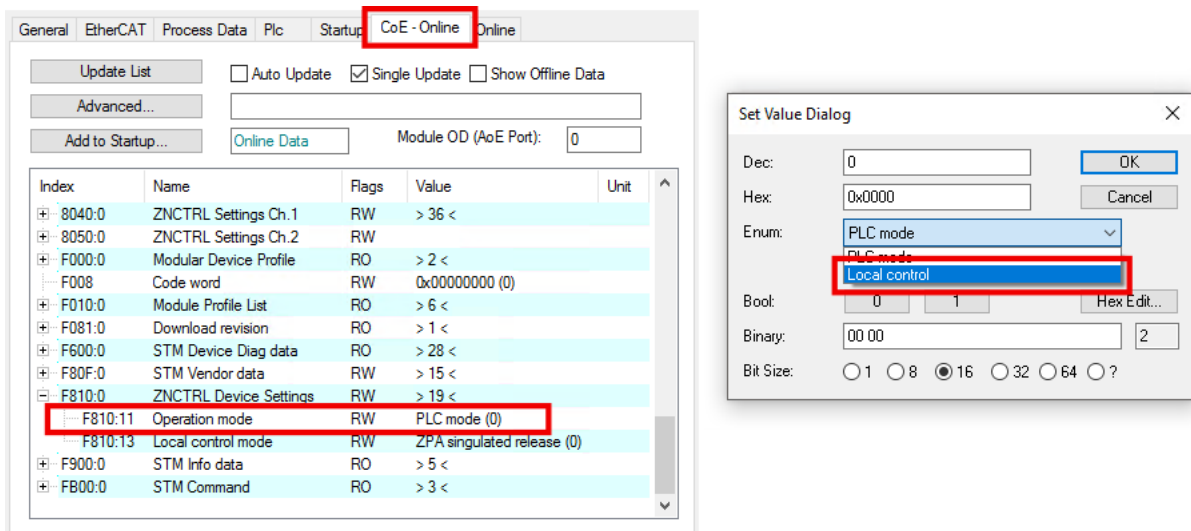

- ⇒ The EP7402 immediately starts ZPA mode and first performs an initialization run. The initialization run takes 10 s. (factory setting)
- ⇒ If the ZPA communication is done via M8 cables, you can now disconnect the EP7402 from the controller.

Performing a test run

1. Start the conveying process. Depending on the structure and cabling of the roller conveyor, the conveying process is started in one of the following ways:
 - Place a package in the detection area of the sensor in the first zone.
 - Press start button
2. If an error occurs that could not be eliminated after checking the cabling and mechanical system:
 - check the [diagnostic bits](#) [► 72].
 - follow the trend of the "Zone State" variables with the help of the chapter [State machine](#) [► 66].
3. If necessary, optimize the ZPA parameters. See [CoE-Objekte 8040 and 8050 "ZNCTRL Settings Ch.n"](#) [► 82].

If required: enable "Train release"

"Train Release" is a release type that allows a higher throughput than the preconfigured release type "Singulated Release". An overview of the release types can be found in the chapter [Release types](#) [► 58].

Enabling procedure:



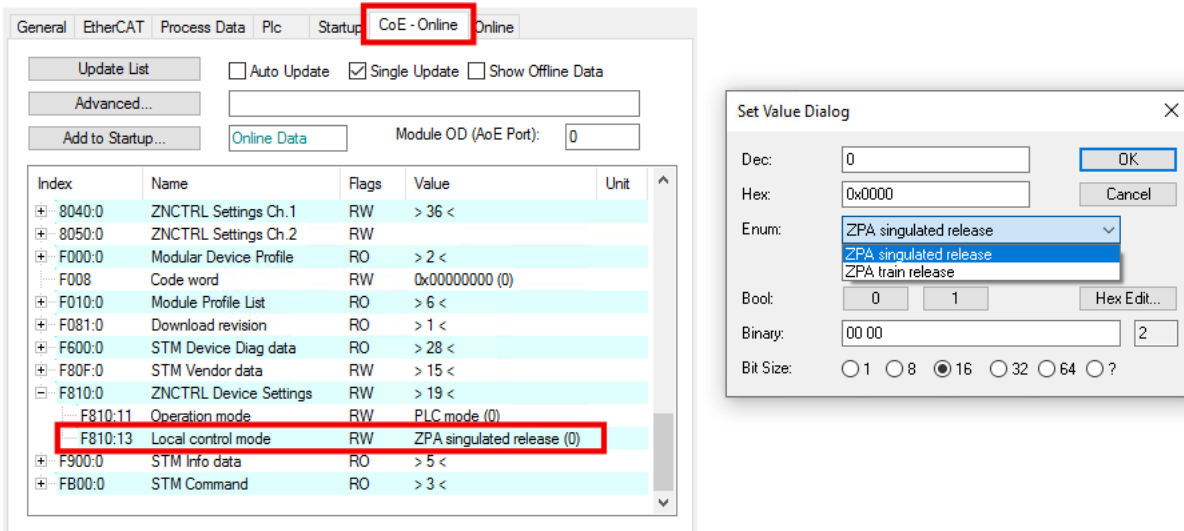







Select value "ZPA train release" in parameter F810:13 "Local control mode".



Then perform another test run and optimize further parameters if necessary.

5.5.6 State machine

The variable "Zone State" contains the current state of the ZPA state machine of a zone.

- ▲  ZNCTRL Inputs Channel 1
 - ▲  Status
 -  Moving
 -  Zone sensor input
 -  Upstream control input value
 -  Upstream control output value
 -  Downstream control input value
 -  Downstream control output value
 -  Reset Input Value
 -  **Zone state**

The following figure shows the internal state machine of a zone or channel of an EP7402.

For a better overview, the following elements are not shown in the figure:

- The Zone State 5 "Disabled".
- The release type "Train Release".

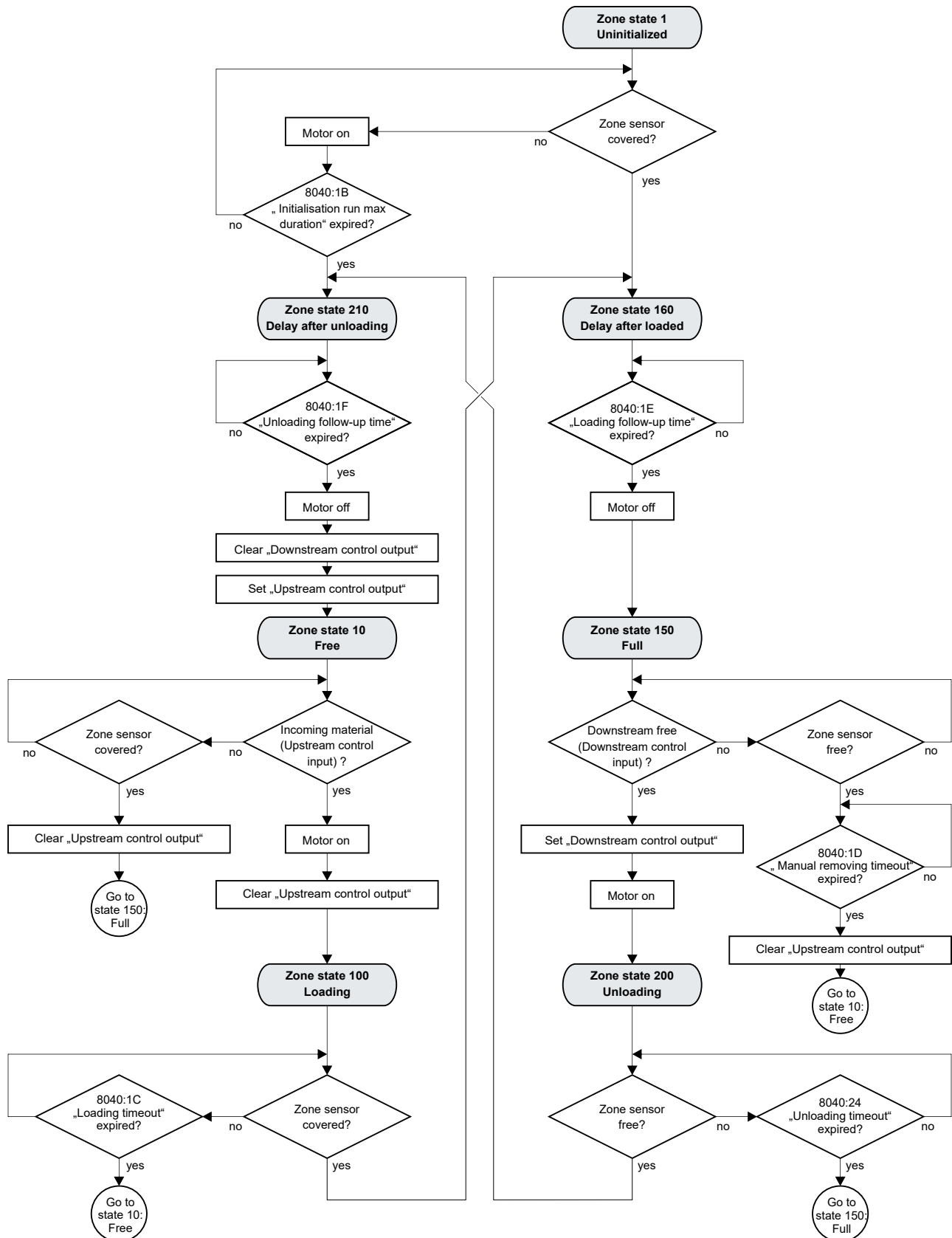

5.5.7 Digital inputs and outputs in ZPA mode

NOTICE

Disturbance of the ZPA mode

In the factory setting, ZPA communication takes place via digital inputs/outputs. If you switch the digital outputs of these inputs/outputs via the process data, the ZPA communication may be disturbed. The result can be, for example, collisions between the conveyed goods.

- Only switch digital outputs of inputs/outputs that are not involved in ZPA communication.
- Make sure that the output variables of all inputs/outputs involved in the ZPA communication are constantly set to 0.
In the factory setting this concerns all variables with the name pattern "Control output x".

i Functionality depending on firmware version

The digital outputs can only be switched in ZPA mode from firmware 05.

Up to and including firmware 04, changes in the signal state of the output variables have no effect in ZPA mode.

In the factory setting, the process data of the digital inputs and outputs are disabled in ZPA mode.

Activating process data

Activate the following process data objects in the "Process Data" tab:

Index	Process data object
0x1600	"DO Outputs"
0x1A00	"DI Inputs"

General EtherCAT **Process Data** Plc Startup CoE - Online Online

Sync Manager:

SM	Size	Type	Flags
0	256	MbxOut	
1	256	MbxIn	
2	4	Outputs	
3	12	Inputs	

PDO List:

Index	Size	Name
0x1A00	2.0	DI Inputs
0x1A01	2.0	STM Status Channel
0x1A02	6.0	STM Synchron info d
0x1A03	2.0	STM Status Channel
0x1A04	6.0	STM Synchron info d
0x1A05	4.0	STM Inputs Device
0x1A06	4.0	ZNCTRL Inputs Char
0x1A07	4.0	ZNCTRL Inouts Char

PDO Assignment (0x1C12):

<input checked="" type="checkbox"/>	0x1600
<input type="checkbox"/>	0x1601
<input type="checkbox"/>	0x1602
<input type="checkbox"/>	0x1603
<input type="checkbox"/>	0x1604
<input checked="" type="checkbox"/>	0x1605
<input checked="" type="checkbox"/>	0x1606

PDO Content (0x1A00):

Index	Size	Offs	Name
0x6000:01	0.1	0.0	Input 1
0x6000:02	0.1	0.1	Input 2
0x6000:03	0.1	0.2	Input 3
0x6000:04	0.1	0.3	Input 4
0x6000:05	0.1	0.4	Control...

Download

PDO Assignment

PDO Configuration

Predefined PDO Assignment: "Local control"

Load PDO info from device

Sync Unit Assignment...

General EtherCAT **Process Data** Plc Startup CoE - Online Online

Sync Manager:

SM	Size	Type	Flags
0	256	MbxOut	
1	256	MbxIn	
2	6	Outputs	
3	14	Inputs	

PDO List:

Index	Size	Name
0x1A00	2.0	DI Inputs
0x1A01	2.0	STM Status Channel
0x1A02	6.0	STM Synchron info d
0x1A03	2.0	STM Status Channel
0x1A04	6.0	STM Synchron info d
0x1A05	4.0	STM Inputs Device
0x1A06	4.0	ZNCTRL Inputs Char
0x1A07	4.0	ZNCTRL Inouts Char

PDO Assignment (0x1C13):

<input checked="" type="checkbox"/>	0x1A00
<input type="checkbox"/>	0x1A01
<input type="checkbox"/>	0x1A02
<input type="checkbox"/>	0x1A03
<input type="checkbox"/>	0x1A04
<input checked="" type="checkbox"/>	0x1A05
<input checked="" type="checkbox"/>	0x1A06

PDO Content (0x1A00):

Index	Size	Offs	Name
0x6000:01	0.1	0.0	Input 1
0x6000:02	0.1	0.1	Input 2
0x6000:03	0.1	0.2	Input 3
0x6000:04	0.1	0.3	Input 4
0x6000:05	0.1	0.4	Control...

Download

PDO Assignment

PDO Configuration

Predefined PDO Assignment: "Local control"

Load PDO info from device

Sync Unit Assignment...

Available inputs/outputs

If ZPA communication takes place via digital inputs/outputs (factory setting), four of the eight digital inputs/ outputs are reserved for ZPA communication.

You can use the other four digital inputs/outputs freely. In the factory setting, these are the inputs/outputs at the sockets X01 and X05 or the variables "Input 1...4" and "Output 1...4":

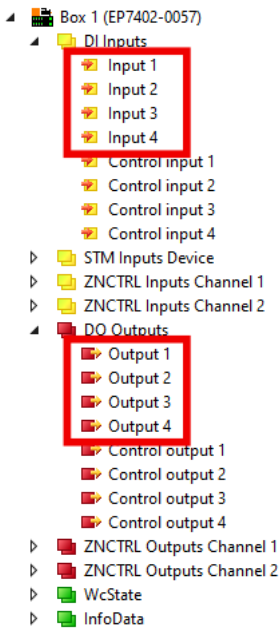

The assignment between the socket numbers and the variable names in TwinCAT can be found in the chapter Assignment of connections and process data [► 18].

Activate the ZPA communication via EtherCAT to be able to use all eight digital inputs/outputs freely. See chapter ZPA communication via EtherCAT [► 62].

5.6 Restore the delivery state

You can restore the delivery state of the backup objects as follows:

1. Ensure that TwinCAT is running in Config mode.
2. In CoE object 1011:0 "Restore default parameters" select parameter 1011:01 "Subindex 001".

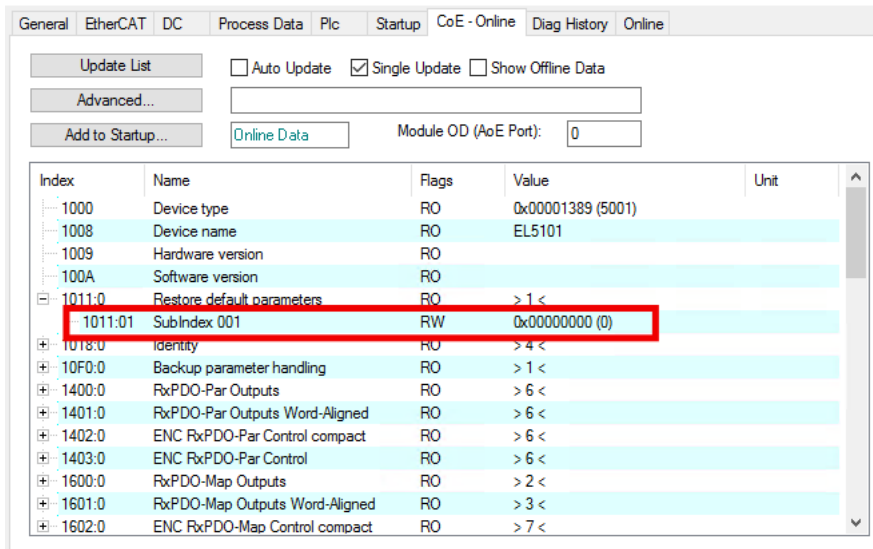

3. Double-click on "Subindex 001".
⇒ The "Set Value Dialog" dialog box opens.
4. Enter the value 1684107116 in the "Dec" field.
Alternatively: enter the value 0x64616F6C in the "Hex" field.

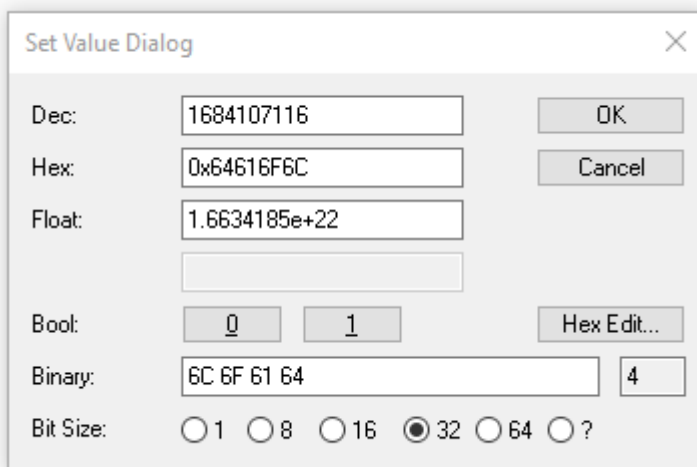

5. Confirm with "OK".
⇒ All backup objects are reset to the delivery state.

● Alternative restore value

With some older modules the backup objects can be changed with an alternative restore value:

Decimal value: 1819238756

Hexadecimal value: 0x6C6F6164

An incorrect entry for the restore value has no effect.

6 Troubleshooting

The following table shows a selection of possible problems and solutions.

Problem	Possible reasons	Possible solutions
The motor is not turning.	The motor channel was blocked due to a fault.	<ol style="list-style-type: none"> 1. Check whether a <u>diagnostic bit</u> [▶ 72] reports an error. 2. Set "Enable" to 0. 3. Eliminate the error. 4. Acknowledge the error. See chapter <u>Acknowledging errors</u> [▶ 74].
	The motor channel is disabled.	Set the variable "Enable" of the corresponding motor channel to 1.
	The variable "Velocity" is smaller than the parameter "Start velocity".	Increase "Velocity" or decrease parameter 80n00:09 _{hex} "Start velocity".
The motor does not react to changes in the output variable "Velocity". It rotates at a constant speed.	The speed controller is disabled because the proportional component is zero.	Set the parameter 80n3:12 _{hex} "Velocity loop proportional gain" to a value greater than zero.
Unexplained failure of an EP7402 or other device powered from the same supply voltage.	<p>Overvoltages on the supply voltage U_p, caused by energy recovery, e.g. in the following events:</p> <ul style="list-style-type: none"> • Braking operations • Manual movement of objects on the conveyor roller 	Use a brake chopper to prevent overvoltages on the supply voltage U_p .

6.1 Diagnosis bits

The diagnostic bits are located in the process data object "STM Inputs Device" [▶ 17].

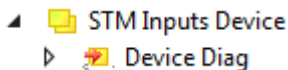

The diagnostic bits indicate warning and error messages.

- **Warning messages ("warning")** are temporary.
A warning message indicates that a measured value lies outside of the nominal range. A warning message is canceled when the measured value is within the nominal range again.
- **Error messages ("error")** are persistent.
If an error occurs, the affected motor channels are disabled until you acknowledge the error. See chapter Acknowledging errors [▶ 74].

There are two different scopes for diagnostic bits:

- Module errors and module warnings concern the entire box.
- Channel-related errors and warnings concern only one motor channel.

The diagnostic bits are subdivided according to these two categories below.

Modul errors and module warnings

If a module error occurs, both motor channels are disabled. Both channels are enabled again when the module error has been correctly acknowledged. See chapter Acknowledging errors [▶ 74].

Bit name	Meaning	Possible reasons	Possible solutions
Device undervoltage	The supply voltage U_p is lower than the threshold value of the undervoltage detection.		Make sure that U_p lies within the nominal voltage range.
Device overvoltage	The supply voltage U_p is higher than the threshold value of the overvoltage detection.		Check the measured value of the voltage U_p in the CoE parameter $F900:05_{hex}$ "Motor supply voltage".
Overtemperature warning	The internal temperature lies above the warning threshold: Parameter F80F:04 Factory setting: 80 °C.	<ul style="list-style-type: none"> • The ambient temperature is too high. • The connected motor does not meet the specifications 	Operate the device only within the specifications [▶ 10].
Overtemperature error	The internal temperature has exceeded the error threshold: Parameter F80F:05 Factory setting: 100 °C.		
General hardware error	The device is not able to initialize successfully.	The device is defective.	None.

Channel-related errors and warnings

If a channel-related error occurs, only the motor channel on which the error occurred is disabled.

Bit name	Meaning	Possible reasons	Possible solutions
Channel <i>n</i> openload	Wire break	<ul style="list-style-type: none"> A motor phase is not connected correctly. A motor phase has burnt out. Faulty triggering of wire break detection: The motor shaft was moved by an external torque when the motor was at standstill. ¹⁾ (for enabled=1 and velocity=0) 	<ul style="list-style-type: none"> Check the motor connection. Replace the motor if it is defective.
Channel <i>n</i> short circuit	At least one phase current has exceeded the value of the parameter "Maximal current": see CoE index 80n00:01. The motor channel has been disabled.	<ul style="list-style-type: none"> A motor phase is short-circuited. The motor is defective. 	<ul style="list-style-type: none"> Check the motor connection. Replace the motor if it is defective.
Channel <i>n</i> motor overload I2T warning	The calculated I ² T value currently exceeds the warning threshold: CoE index 80n0:16 [▶ 79]. Default: 80 %.	If the warning occurs during the ramp-up phase: The output current is too high.	Decrease the parameter "Sensorless offset scaling": CoE index 80n3:14 [▶ 81].
		If the warning occurs during continuous operation: Mechanical overload.	Reduce the load.
Channel <i>n</i> motor overload I2T error	The calculated I ² T value has exceeded the error threshold: CoE index 80n0:18 [▶ 79]. Default: 110 %.	If the error occurs during the ramp-up phase: The output current is too high.	Decrease the parameter "Sensorless offset scaling": CoE index 80n3:14 [▶ 81].
		If the error occurs during continuous operation: Mechanical overload.	Reduce the load.
Channel <i>n</i> amplifier overload I2T warning	The calculated I2T value of the amplifier currently exceeds the warning threshold:	Incorrect parameter setting: The thermal limit of motors that meet the specifications is usually much lower than the thermal limit of the amplifier.	Check the motor parameters: CoE index 80n0 [▶ 79].
Channel <i>n</i> amplifier overload I2T error	The calculated I ² T value has exceeded the error threshold:		
Channel <i>n</i> in limit	The current is currently being limited because the I ² T value of the motor exceeds 97 %.	Mechanical overload	You can disable this protective function by setting the parameter 80n3:03 to TRUE.
Channel <i>n</i> commutation error	The commutation algorithm has determined that the rotary field and the rotor are not running synchronously. Hint: You can have "commutation errors" acknowledged automatically. See chapter Autoacknowledge: acknowledge errors automatically [▶ 55].	If this bit is set during the ramp-up phase: <ul style="list-style-type: none"> Mechanical overload ²⁾ The output current is too low. The parameter "ramp-up velocity" is too high. 	<ul style="list-style-type: none"> Check the motor load. Increase the value of the "Sensorless offset scaling" parameter: CoE index 80n3:14. Reduce the value of the "Rampup velocity" parameter: CoE index 80n3:19
		If this bit is set in continuous operation: The velocity (output variable "Velocity") is too low.	Try again at a higher velocity. Increase the value of the parameter "Start velocity" (CoE-Index 80n0:09 [▶ 79]) to ensure that the motor does not start with too low velocity preset.

¹⁾ This happens, for example, when a package is conveyed from the previous zone and the package rotates the non-driven conveyor roller due to its forward movement.

²⁾ Especially likely when the motor makes a noise with increasing pitch.

6.2 Acknowledging errors

There are two categories of errors that have to be acknowledged in different ways:

- Module error
- Channel-related errors

In order to find out which category the currently pending error belongs to, refer to the chapter [Diagnosis bits](#) [► 72]. The diagnostic bits are subdivided there into the above-mentioned categories.

Acknowledging module errors

You can acknowledge module errors in two ways:

- by software: both motor channels have a "Reset" variable. Apply a positive edge to each "Reset" variable.

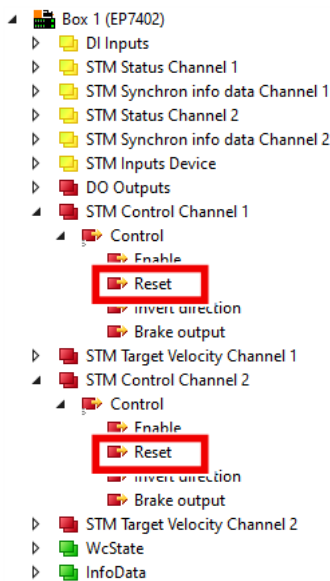

- by hardware (only in ZPA mode): apply a positive edge to the reset inputs of both channels. See CoE parameters [8040:12](#) [► 82] and [8050:12](#) [► 83].

It is not sufficient to acknowledge the error on only one motor channel. The module error and the disablement of both motor channels are only canceled when the error has been acknowledged on both motor channels.

Even if a motor channel is not being used, the error must be acknowledged on this channel.

Acknowledge channel-related errors

You can acknowledge channel-related errors in two ways:

- by software: apply a positive edge to the "Reset" variable of the motor channel affected. The "Reset" variable is located in the process data object "STM Control Channel *n*" (*n* = 1...2).
- by hardware (only in ZPA mode): apply a positive edge to the reset input of the affected channel. See CoE parameters [8040:12](#) [► 82] and [8050:12](#) [► 83].

Troubleshooting

- If an error message persists after acknowledgement, the error has probably not yet been eliminated.
- To successfully acknowledge the error "Open Load", you must first set "Enable" to 0.

7 Decommissioning

⚠ WARNING**Risk of electric shock!**

Bring the bus system into a safe, de-energized state before starting disassembly of the devices!

8 Application Hints

8.1 Motor Diagnosis

You can use the I²T value for long-term diagnosis and wear-detection of the motor and attached mechanics.

1. Map the I²T value to one of the “Info data” variables in “STM Synchron info data Channel n”. [CoE index 80n2 “STM Features”](#) [► 80].
2. Monitor the “Info data” variable in a scope project.
 - ⇒ This enables to recognize irregularities.

Example scope recording

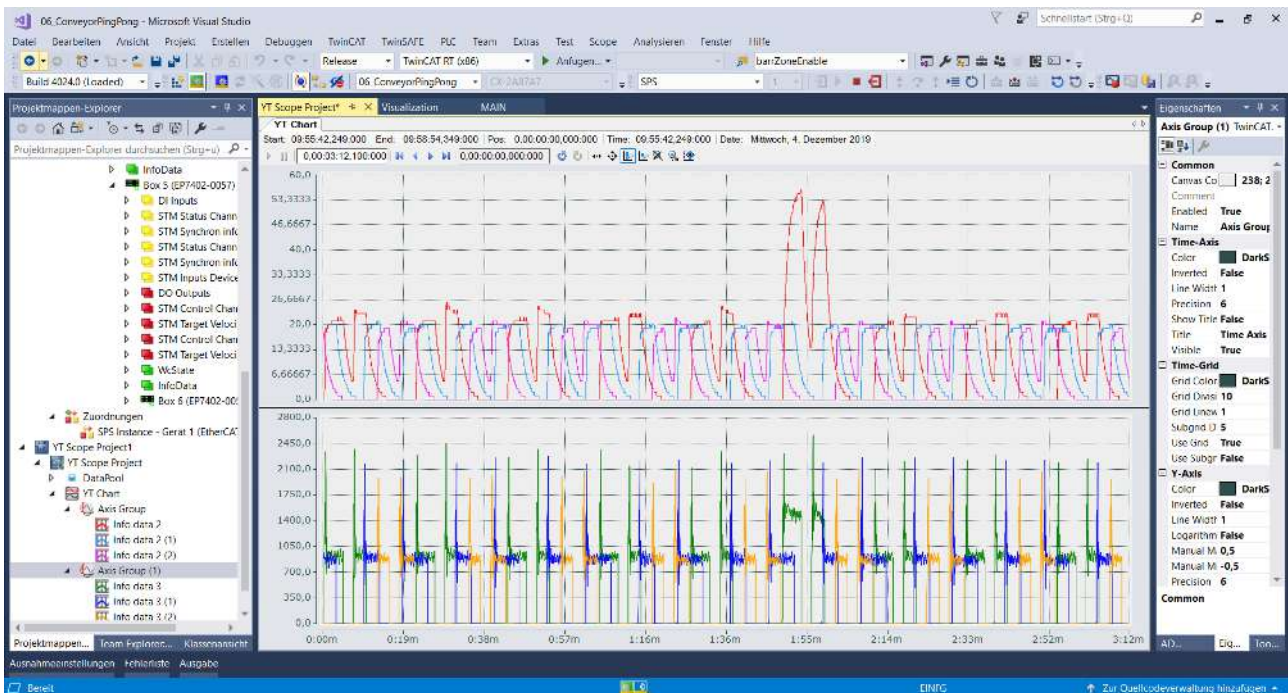

9 CoE objects

9.1 Register

Index (hex)	Name
1000	Device type [▶ 86]
1008	Device name [▶ 86]
1009	Hardware version [▶ 86]
100A	Software version [▶ 86]
100B	Bootloader version
1011	Restore default parameters
1018	Identity
10F0	Backup parameter handling
1600	DO RxPDO-Map Outputs
1601	STM RxPDO-Map Control Ch. 1
1602	STM RxPDO-Map Target Velocity Ch. 1
1603	STM RxPDO-Map Control Ch. 2
1604	STM RxPDO-Map Target Velocity Ch. 2
1605	ZNCTRL RxPDO-Map Outputs Ch.1
1606	ZNCTRL RxPDO-Map Outputs Ch.2
1A00	DI TxPDO-Map Inputs
1A01	STM TxPDO-Map Status Ch. 1
1A02	STM TxPDO-Map Synchron info data Ch. 1
1A03	STM TxPDO-Map Status Ch. 1
1A04	STM TxPDO-Map Synchron info data Ch. 1
1A05	STM TxPDO-Map Inputs Device
1A06	ZNCTRL TxPDO-Map Inputs Ch.1
1A07	ZNCTRL TxPDO-Map Inputs Ch.2
1C00	Sync manager type
1C12	RxPDO assign
1C13	TxPDO assign
1C32	SM output parameter
1C33	SM input parameter
6000	DI Inputs
6020	STM Inputs Ch.1
6030	STM Inputs Ch.2
6040	ZNCTRL Inputs Ch.1
6050	ZNCTRL Inputs Ch.2
7010	DO Outputs
7020	STM Outputs Ch.1
7030	STM Outputs Ch.2
7040	ZNCTRL Outputs Ch.1
7050	ZNCTRL Outputs Ch.2
8020	STM Motor Settings Ch.1 [▶ 79]
8022	STM Features Ch.1 [▶ 80]
8023	STM Controller Settings 4 Ch.1 [▶ 81]
8030	STM Motor Settings Ch.2 [▶ 79]
8032	STM Features Ch.2 [▶ 80]
8033	STM Controller Settings 4 Ch.2 [▶ 81]
8040	ZNCTRL Settings Ch.1 [▶ 82]
8050	ZNCTRL Settings Ch.2 [▶ 82]

Index (hex)	Name
F000	Modular Device Profile
F008	Code word
F010	Module Profile List
F081	Download revision
F600	STM Device Diag data
F80F	<u>STM Vendor data</u> [▶ 85]
F900	<u>STM Info data</u> [▶ 85]
F810	<u>ZNCTRL Device Settings</u> [▶ 84]

9.2 Object descriptions

9.2.1 Parameterization objects

Set these parameters during commissioning.

Index 8020: STM Motor Settings Ch. 1

Index 8030: STM Motor Settings Ch. 2

Access rights: read/write

Index (hex)	Name	Description	Unit	Data type	Default value
8020:01 8030:01	Peak current	If the motor current exceeds this value, the output stage of the affected channel is disabled and the diagnostic bit "Channel n short circuit" is set.	mA	UINT	1000 _{dec}
8020:02 8030:02	Rated current	The rated current of the motor. See motor data sheet. This parameter is used for the I ² T calculation of the motor. (Thermal overload protection)	mA	UINT	1000 _{dec}
8020:03 8030:03	Rated voltage	The rated voltage of the motor. See motor data sheet.	0.01 V	UINT	2400 _{dec}
8020:04 8030:04	Phase to phase resistance	The ohmic resistance between two motor phases.	0.01 Ω	UINT	100 _{dec}
8020:09 8030:09	Start velocity	Threshold value: the motor is kept in align state if the value of the output variable "velocity" is lower than this value. If this value is too low, a commutation error may occur.	°/s	UINT	3000 _{dec}
8020:13 8030:13	Mechanical to electrical ratio	Set this parameter to the number of pole pairs of the motor multiplied by the gear ratio. The value for this parameter can also be <u>determined experimentally</u> [► 53].	-	UINT	1
8020:14 8030:14	Rated velocity				5000 _{dec}
8020:16 8030:16	I ² T warn level	I ² T limit monitoring: Warning threshold. If the I ² T value exceeds this threshold, the "Channel n overload I ² T warning" bit is set.	%	USINT	80 _{dec}
8020:18 8030:18	I ² T error level	I ² T limit monitoring: Error threshold. If the I ² T value exceeds this threshold, the "Channel n overload I ² T error" bit is set. The motor is switched torqueless.	%	USINT	110 _{dec}
8020:19 8030:19	Motor thermal time constant	I ² T limit monitoring: Thermal time constant. The thermal time constant can be found in the motor datasheet.	0.1 s	UINT	15 _{dec}

Index 8022: STM Features Channel 1**Index 8032: STM Features Channel 2**

Access rights: read/write

Index (hex)	Name	Description	Unit	Data type	Default
8022:11 8032:11	Select info data 1	Here you can define which measured values are assigned to the input variables in the process data object <u>STM_Synchron info data Channel n</u> ▶ 16 . Enum:	-	USINT	7 _{dec}
8022:19 8032:19	Select info data 2		-	USINT	11 _{dec}
8022:51 8032:51	Select info data 3		-	USINT	13 _{dec}

Index 8023: STM Controller Settings 4 Ch. 1

Index 8033: STM Controller Settings 4 Ch. 2

Access rights: read/write

Index (hex)	Name	Description	Unit	Data type	Default value
8023:02 8033:02	Disable stop after unsuccessful rampup	This prevents a commutation error after unsuccessful ramping up the motor. The commutation is continued at Rampup velocity.	-	BOOL	FALSE
8023:03 8033:03	Disable motor diagnosis	This parameter disables the motor protection functions during the alignment phase.	-	BOOL	FALSE
8023:04 8033:04	Disable I2T current limiting	This bit disables the I2T current limiting above a 97% limit. This could be unstable during low velocities. FALSE: The output current is limited when the motor I ² T value exceeds 97 %. TRUE: no current limiting.	-	BOOL	FALSE
8023:11 8033:11	Velocity loop integral time	Velocity controller parameter: Integral time T _i	0.1 ms	UDINT	500 _{dec}
8023:12 8033:12	Velocity loop proportional gain	Velocity controller parameter: Proportional coefficient K _p	µV (°/s)	UDINT	100 _{dec}
8023:13 8033:13	Velocity feed forward gain	Bypasses the velocity controller directly with its Target voltage. With correct Rated voltage and speed the Actual velocity will be close to the Target velocity at 100% Feed Forward.	%	USINT	0
8023:14 8033:14	Sensorless offset scaling	This parameter affects the output current during alignment and rampup phase. The output current is specified in percent of the nominal current, CoE index 80n0:02.	%	USINT	50 _{dec}
8023:15 8033:15	Align duration	Duration of the alignment phase	ms	UINT	1000 _{dec}
8023:18 8033:18	Rampup duration	Duration of the ramp-up phase	ms	UINT	1000 _{dec}
8023:19 8033:19	Rampup velocity	Target velocity for the roller at the end of the ramp-up phase. See also subindex 02 _{hex} .	°/s	UINT	3000 _{dec}
8023:21 8033:21	Rampup needed switchover events	The amount successful commutations which are needed to switch from forced commutation (ramp-up phase) to regulated commutation.	-	UINT	20 _{dec}
8023:22 8033:22	Commutation threshold	This value is to modify the commutation for different motors.	-	UINT	50 _{dec}
8023:23 8033:23	Current loop proportional gain	Proportional component of current controller	0.1 V/A	UINT	2
8023:24 8033:24	Current loop integral time	Current controller integral action time (T _n)	0.1 ms	UINT	20 _{dec}
8023:25 8033:25	Restart after error number of repetition	<u>Autoacknowledge: acknowledge errors automatically [►_55]</u> If a commutation error occurs, the motor can be restarted automatically. This parameter determines the number of commutation errors and restarts that may occur before the motor is finally switched off. If this parameter is zero, the motor will be switched off immediately after a commutation error in nominal operation.	-	UINT	0
8023:26 8033:26	Restart after error delay	This parameter determines the time span between a commutation error and the automatic restart. See also subindex 25.	ms	UINT	1000 _{dez}

Index 8040_{hex}: ZNCTRL Settings Ch.1

Access rights: read/write

Index (hex)	Name	Description	Unit	Data type	Default value
8040:01	Disable zone	Disable ZPA operation for this zone.	-	BOOL	FALSE
8040:03	Invert motor direction	Reversal of the direction of rotation of the motor. If the motor phases have been connected the wrong way round, the motor will rotate in the wrong direction. With this parameter you can correct this without having to rewire the motor.	-	BOOL	FALSE
8040:04	Disable motor in stop	Set the motor torqueless when not moving.	-	BOOL	FALSE
8040:12	External reset input hardware selection	Selection of the digital input for an external reset signal. The assignment of the connection designations can be found in the chapter Digital input/outputs [▶ 38].	-	UINT16	0 "None"
8040:13	Zone sensor input hardware selection	Selection of the digital input for the zone sensor. Recommendation: change this parameter only if you need to invert the sensor signal. See chapter "Cabling", section Sensor signals [▶ 61].	-	UINT16	1 "Input 1"
8040:14	Upstream control input hardware selection	Configuration of digital inputs and outputs for ZPA communication. Change these parameters only if you know exactly what you are doing.	-	UINT16	65 _{dec} "Control input 1"
8040:15	Upstream control output hardware selection	These parameters must be in the factory setting for the ZPA communication via M8 cables to work.	-	UINT16	66 _{dec} "Control output 2"
8040:16	Downstream control input hardware selection	The assignment of the connection designations can be found in the chapter Digital input/outputs [▶ 38].	-	UINT16	130 _{dec} "Internal variable 2"
8040:17	Downstream control output hardware selection		-	UINT16	129 _{dec} "Internal variable 1"
8040:1B	Initialization run max duration	The maximum duration of the initialization run.	ms	UINT16	10000 _{dec} (10 s)
8040:1C	Loading timeout	The maximum duration for accepting a package from the previous zone. If the time is exceeded, the zone is assumed to be empty.	ms	UINT16	10000 _{dec} (10 s)
8040:1D	Manual removing timeout	If a package leaves the detection zone of the sensor even though it was not conveyed further by the motor, it is assumed that the package was removed manually. The controller then waits a period of time before assuming that the zone is actually empty. The timespan is set by this parameter.	ms	UINT16	1000 _{dec} (1 s)
8040:1E	Loading follow-up time	When the zone accepts a package, the motor runs until the sensor detects the package. The motor then continues to run for a short period of time to ensure that the package is safely within the sensor's detection range. The timespan is set by this parameter.	ms	UINT16	200 _{dec}
8040:F1	Unloading follow-up time	If the zone continues to convey a package, the motor runs until the package leaves the detection range of the sensor. The motor then continues to run for a short period of time to ensure that the package has been detected by the rollers of the subsequent zone. The timespan is set by this parameter. The closer the sensor is to the end of the zone, the shorter this timespan must be.	ms	UINT16	1000 _{dec} (1 s)
8040:20	Motor velocity	Presetting of the motor speed.	° / s	INT16	360 _{dec}
8040:21	Motor acceleration	Preset of the acceleration ramp when starting the motor.	° / s ²	UINT16	10000 _{dec}
8040:22	Motor deceleration	Presetting of the braking ramp when stopping the motor.	° / s ²	UINT16	10000 _{dec}
8040:23	Train Release Delay	Delay time for "Train Release". This delay time prevents current peaks that would result from starting multiple motors at the same time.	ms	UINT16	100 _{dec} (100 ms)
8040:24	Unloading timeout	The maximum duration for conveying a package out of the zone. If the time is exceeded, the zone is still assumed to be full.	ms	UINT16	10000 _{dec} (10 s)

Index 8050_{hex}: ZNCTRL Settings Ch.2

Access rights: read/write

Index (hex)	Name	Description	Unit	Data type	Default value
8050:01	Disable zone	Disable ZPA operation for this zone.	-	BOOL	FALSE
8050:03	Invert motor direction	Reversal of the direction of rotation of the motor. If the motor phases have been connected the wrong way round, the motor will rotate in the wrong direction. With this parameter you can correct this without having to rewire the motor.	-	BOOL	FALSE
8050:04	Disable motor in stop	Set the motor torqueless when not moving.	-	BOOL	FALSE
8050:12	External reset input hardware selection	Selection of the digital input for an external reset signal. The assignment of the connection designations can be found in the chapter Digital input/outputs [▶ 38].	-	UINT16	0 "None"
8050:13	Zone sensor input hardware selection	Selection of the digital input for the zone sensor. Recommendation: change this parameter only if you need to invert the sensor signal. See chapter "Cabling", section Sensor signals [▶ 61].	-	UINT16	3 "Input 3"
8050:14	Upstream control input hardware selection	Configuration of digital inputs and outputs for ZPA communication. Change these parameters only if you know exactly what you are doing.	-	UINT16	129 "Internal variable 1"
8050:15	Upstream control output hardware selection	These parameters must be in the factory setting for the ZPA communication via M8 cables to work.	-	UINT16	130 "Internal variable 2"
8050:16	Downstream control input hardware selection	The assignment of the connection designations can be found in the chapter Digital input/outputs [▶ 38].	-	UINT16	68 _{dec} "Control input 4"
8050:17	Downstream control output hardware selection		-	UINT16	67 _{dec} "Control output 3"
8050:1B	Initialization run max duration	The maximum duration of the initialization run.	ms	UINT16	10000 _{dec} (10 s)
8050:1C	Loading timeout	The maximum duration for accepting a package from the previous zone. If the time is exceeded, the zone is assumed to be empty.	ms	UINT16	10000 _{dec} (10 s)
8050:1D	Manual removing timeout	If a package leaves the detection zone of the sensor even though it was not conveyed further by the motor, it is assumed that the package was removed manually. The controller then waits a period of time before assuming that the zone is actually empty. The timespan is set by this parameter.	ms	UINT16	1000 _{dec} (1 s)
8050:1E	Loading follow-up time	When the zone accepts a package, the motor runs until the sensor detects the package. The motor then continues to run for a short period of time to ensure that the package is safely within the sensor's detection range. The timespan is set by this parameter.	ms	UINT16	200 _{dec}
8050:F1	Unloading follow-up time	If the zone continues to convey a package, the motor runs until the package leaves the detection range of the sensor. The motor then continues to run for a short period of time to ensure that the package has been detected by the rollers of the subsequent zone. The timespan is set by this parameter. The closer the sensor is to the end of the zone, the shorter this timespan must be.	ms	UINT16	1000 _{dec} (1 s)
8050:20	Motor velocity	Presetting of the motor speed.	° / s	INT16	360 _{dec}
8050:21	Motor acceleration	Preset of the acceleration ramp when starting the motor.	° / s ²	UINT16	10000 _{dec}
8050:22	Motor deceleration	Presetting of the braking ramp when stopping the motor.	° / s ²	UINT16	10000 _{dec}
8050:23	Train Release Delay	Delay time for "Train Release". This delay time prevents current peaks that would result from starting multiple motors at the same time.	ms	UINT16	100 _{dec} (100 ms)
8050:24	Unloading timeout	The maximum duration for conveying a package out of the zone. If the time is exceeded, the zone is still assumed to be full.	ms	UINT16	10000 _{dec} (10 s)

Index F810_{hex}: ZNCTRL Device Settings

Access rights: read/write

Index (hex)	Name	Description	Unit	Data type	Default value
F810:11	Operation mode	Setting the operation mode: <ul style="list-style-type: none"> • 0: PLC mode • 16_{dec}: Local control 	-		0
F810:13	Local control mode	Set ZPA release type: <ul style="list-style-type: none"> • 0: ZPA singulated release • 1: ZPA train release See chapter Release types [► 58] .	-		0
F810:14	Autoacknowledge number of attempts	See chapter Autoacknowledge: acknowledge errors automatically [► 55] .	-		0
F810:15	Autoacknowledge delay	See chapter Autoacknowledge: acknowledge errors automatically [► 55] .	ms		0x03E8 (1000 _{dec})

9.2.2 Information objects

Index F80F: STM Vendor data

Access rights: read only

Index (hex)	Name	Description	Unit	Data type	Value
F80F:04	Warning temperature	Internal temperature: Warning threshold.	°C	USINT	80 _{dec}
F80F:05	Switch off temperature	Internal temperature: Error threshold.	°C	USINT	100 _{dec}
F80F:09	Amplifier rated current	The value of this parameter is the maximum continuous current that the output stage can provide. This parameter is used for the I ² T calculation of the output stage.	mA	UINT	4500 _{dec}
F80F:0A	Amplifier maximal current	If the output current exceeds the value of this parameter, the output stage is switched off.	mA	UINT	18000 _{dec}
F80F:0B	Amplifier minimal voltage	Threshold value of the undervoltage detection.	0.01 V	UINT	1800 _{dec}
F80F:0C	Amplifier maximal voltage	Threshold value of the overvoltage detection.	0.01 V	UINT	3000 _{dec} (EP7402-0057) 6000 _{dec} (EP7402-0167)
F80F:0D	Amplifier thermal time constant	I ² T limit value monitoring: Thermal time constant of the output stage.	0.1 s	UINT	35 _{dec}

Index F900: STM Info data

Access rights: read only

Index (hex)	Name	Description	Unit	Data type	Default value
F900:01	Internal temperature	Internal temperature	°C	SINT	-
F900:02	Motor supply voltage	Current value of the peripheral voltage U _p	0.01 V	UINT	-

9.2.3 Standard objects

Index 1000 Device type

Access rights: read only

Index (hex)	Name	Description	Unit	Data type	Value
1000:0	Device type	Bit 0 ... 15: Device profile number Bit 16 ... 31: Module profile number (Device profile number 5001: Modular Device Profile MDP)	-	UDINT	5001 _{dec}

Index 1008 Device name

Access rights: read only

Index (hex)	Name	Description	Unit	Data type	Value
1008:0	Device Name	Device Name	-	String	"EP7402-0057" or "EP7402-0167"

Index 1009 Hardware version

Access rights: read only

Index (hex)	Name	Description	Unit	Data type	Value
1009:0	Hardware Version	Hardware revision	-	String	¹⁾

¹⁾ Refer to [Firmware and hardware versions](#) [▶ 7].

Index 100A Software version

Access rights: read only

Index (hex)	Name	Description	Unit	Data type	Value
100A:0	Software Version	Firmware revision	-	String	¹⁾

¹⁾ Refer to [Firmware and hardware versions](#) [▶ 7].

10 Appendix

10.1 Example motor parameters

Parameter		Beckhoff AM8111-OF20-0000
Index	Name	
8020:01 _{hex}	Maximal current	3500
8020:02 _{hex}	Nominal current	2850
8020:09 _{hex}	Start velocity	666
8020:13 _{hex}	Mechanical to electrical ratio	3
8020:19 _{hex}	Motor thermal time constant	15
8023:11 _{hex}	Velocity loop integral time	300
8023:12 _{hex}	Velocity loop proportional gain	100
8023:14 _{hex}	Align power	53
8023:15 _{hex}	Align duration	1000
8023:16 _{hex}	Rampup power	60
8023:18 _{hex}	Rampup duration	666
8023:19 _{hex}	Rampup velocity	2000
8023:21 _{hex}	Rampup needed switchover events	10
8023:22 _{hex}	Commutation threshold	45

10.2 General operating conditions

Protection rating according to IP code

The degrees of protection are defined and divided into different classes in the IEC 60529 standard (EN 60529). Degrees of protection are designated by the letters "IP" and two numerals: **IPxy**

- Numeral x: Dust protection and contact protection
- Numeral y: Protection against water

x	Meaning
0	Not protected
1	Protected against access to dangerous parts with the back of the hand. Protected against solid foreign objects of 50 mm Ø
2	Protected against access to dangerous parts with a finger. Protected against solid foreign objects of 12.5 mm Ø
3	Protected against access to dangerous parts with a tool. Protected against solid foreign objects of 2.5 mm Ø
4	Protected against access to dangerous parts with a wire. Protected against solid foreign objects of 1 mm Ø
5	Protection against access to dangerous parts with a wire. Dust-protected. Ingress of dust is not prevented completely, although the quantity of dust able to penetrate is limited to such an extent that the proper function of the device and safety are not impaired
6	Protection against access to dangerous parts with a wire. Dust-tight. No ingress of dust

y	Meaning
0	Not protected
1	Protection against vertically falling water drops
2	Protection against vertically falling water drops when enclosure tilted up to 15°
3	Protection against spraying water. Water sprayed at an angle of up to 60° on either side of the vertical shall have no harmful effects
4	Protection against splashing water. Water splashed against the enclosure from any direction shall have no harmful effects
5	Protection against water jets.
6	Protection against powerful water jets.
7	Protected against the effects of temporary immersion in water. Ingress of water in quantities causing harmful effects shall not be possible when the enclosure is immersed in water at a depth of 1 m for 30 minutes

Chemical resistance

The resistance refers to the housing of the IP67 modules and the metal parts used. In the table below you will find some typical resistances.

Type	Resistance
Water vapor	unstable at temperatures > 100 °C
Sodium hydroxide solution (ph value > 12)	stable at room temperature unstable > 40 °C
Acetic acid	unstable
Argon (technically pure)	stable

Key

- resistant: Lifetime several months
- non inherently resistant: Lifetime several weeks
- not resistant: Lifetime several hours resp. early decomposition

10.3 Accessories

Cables

Ordering information	Description	Link
ZK1090-3xxx-xxxx	EtherCAT cable M8, green	Website
ZK1093-3xxx-xxxx	EtherCAT cable M8, yellow	Website
ZK2000-3xxx-xxxx	Sensor cable M8, 4-pin	Website
ZK2020-3xxx-xxxx	Power cable M8, 4-pin	Website
ZK2080-4100-0xxx	Motor cable M8, 5-pin, B-coded	Website
ZK7314-3xxx-Axxx	Hybrid cable B23 ENP, 5 G 4.0 mm ²	Website

Protective caps for connectors

Ordering information	Description
ZS5000-0010	Protective cap for M8 sockets, IP67 (50 pieces)
ZS7300-B001	Protective cap for B23, plastic
ZS7300-B002	Protective cap for B23, metal

Tools

Ordering information	Description
ZB8801-0000	Torque wrench for plugs, 0.4...1.0 Nm
ZB8801-0001	Torque cable key for M8 / wrench size 9 for ZB8801-0000
ZB8802-0003	Assembly tool for B23 connectors



Further accessories

Further accessories can be found in the price list for fieldbus components from Beckhoff and online at <https://www.beckhoff.com>.

10.4 Version identification of EtherCAT devices

10.4.1 General notes on marking

Designation

A Beckhoff EtherCAT device has a 14-digit designation, made up of

- family key
- type
- version
- revision

Example	Family	Type	Version	Revision
EL3314-0000-0016	EL terminal 12 mm, non-pluggable connection level	3314 4-channel thermocouple terminal	0000 basic type	0016
ES3602-0010-0017	ES terminal 12 mm, pluggable connection level	3602 2-channel voltage measurement	0010 high-precision version	0017
CU2008-0000-0000	CU device	2008 8-port fast ethernet switch	0000 basic type	0000

Notes

- The elements mentioned above result in the **technical designation**. EL3314-0000-0016 is used in the example below.
- EL3314-0000 is the order identifier, in the case of "-0000" usually abbreviated to EL3314. "-0016" is the EtherCAT revision.
- The **order identifier** is made up of
 - family key (EL, EP, CU, ES, KL, CX, etc.)
 - type (3314)
 - version (-0000)
- The **revision** -0016 shows the technical progress, such as the extension of features with regard to the EtherCAT communication, and is managed by Beckhoff.
In principle, a device with a higher revision can replace a device with a lower revision, unless specified otherwise, e.g. in the documentation.
Associated and synonymous with each revision there is usually a description (ESI, EtherCAT Slave Information) in the form of an XML file, which is available for download from the Beckhoff web site.
From 2014/01 the revision is shown on the outside of the IP20 terminals, see Fig. "EL5021 EL terminal, standard IP20 IO device with batch number and revision ID (since 2014/01)".
- The type, version and revision are read as decimal numbers, even if they are technically saved in hexadecimal.

10.4.2 Version identification of IP67 modules

The serial number/ data code for Beckhoff IO devices is usually the 8-digit number printed on the device or on a sticker. The serial number indicates the configuration in delivery state and therefore refers to a whole production batch, without distinguishing the individual modules of a batch.

Structure of the serial number: **KK YY FF HH**

KK - week of production (CW, calendar week)
 YY - year of production
 FF - firmware version
 HH - hardware version

Example with serial number 12 06 3A 02:

12 - production week 12
 06 - production year 2006
 3A - firmware version 3A
 02 - hardware version 02

Exceptions can occur in the **IP67 area**, where the following syntax can be used (see respective device documentation):

Syntax: D ww yy x y z u

D - prefix designation
 ww - calendar week
 yy - year
 x - firmware version of the bus PCB
 y - hardware version of the bus PCB
 z - firmware version of the I/O PCB
 u - hardware version of the I/O PCB

Example: D.22081501 calendar week 22 of the year 2008 firmware version of bus PCB: 1 hardware version of bus PCB: 5 firmware version of I/O PCB: 0 (no firmware necessary for this PCB) hardware version of I/O PCB: 1

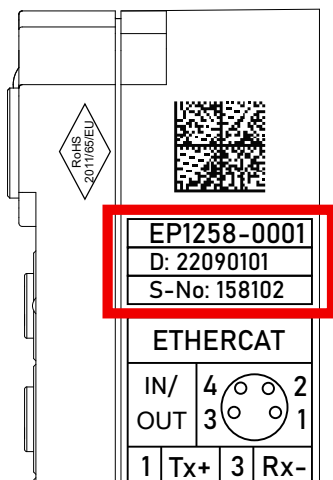

Fig. 8: EP1258-00001 IP67 EtherCAT Box with batch number/DateCode 22090101 and unique serial number 158102

10.4.3 Beckhoff Identification Code (BIC)

The Beckhoff Identification Code (BIC) is increasingly being applied to Beckhoff products to uniquely identify the product. The BIC is represented as a Data Matrix Code (DMC, code scheme ECC200), the content is based on the ANSI standard MH10.8.2-2016.



Fig. 9: BIC as data matrix code (DMC, code scheme ECC200)

The BIC will be introduced step by step across all product groups.

Depending on the product, it can be found in the following places:

- on the packaging unit
- directly on the product (if space suffices)
- on the packaging unit and the product

The BIC is machine-readable and contains information that can also be used by the customer for handling and product management.

Each piece of information can be uniquely identified using the so-called data identifier (ANSI MH10.8.2-2016). The data identifier is followed by a character string. Both together have a maximum length according to the table below. If the information is shorter, spaces are added to it.

Following information is possible, positions 1 to 4 are always present, the other according to need of production:

Position	Type of information	Explanation	Data identifier	Number of digits incl. data identifier	Example
1	Beckhoff order number	Beckhoff order number	1P	8	1P 072222
2	Beckhoff Traceability Number (BTN)	Unique serial number, see note below	SBTN	12	S BTNk4p562d7
3	Article description	Beckhoff article description, e.g. EL1008	1K	32	1K EL1809
4	Quantity	Quantity in packaging unit, e.g. 1, 10, etc.	Q	6	Q 1
5	Batch number	Optional: Year and week of production	2P	14	2P 401503180016
6	ID/serial number	Optional: Present-day serial number system, e.g. with safety products	51S	12	51S 678294
7	Variant number	Optional: Product variant number on the basis of standard products	30P	32	30P F971, 2*K183
...					

Further types of information and data identifiers are used by Beckhoff and serve internal processes.

Structure of the BIC

Example of composite information from positions 1 to 4 and with the above given example value on position 6. The data identifiers are highlighted in bold font:

1P072222**S**BTNk4p562d7**1K**EL1809 **Q**1 **51S**678294

Accordingly as DMC:



Fig. 10: Example DMC **1P**072222**S**BTNk4p562d7**1K**EL1809 **Q**1 **51S**678294

BTN

An important component of the BIC is the Beckhoff Traceability Number (BTN, position 2). The BTN is a unique serial number consisting of eight characters that will replace all other serial number systems at Beckhoff in the long term (e.g. batch designations on IO components, previous serial number range for safety products, etc.). The BTN will also be introduced step by step, so it may happen that the BTN is not yet coded in the BIC.

NOTICE
<p>This information has been carefully prepared. However, the procedure described is constantly being further developed. We reserve the right to revise and change procedures and documentation at any time and without prior notice. No claims for changes can be made from the information, illustrations and descriptions in this information.</p>

10.4.4 Electronic access to the BIC (eBIC)

Electronic BIC (eBIC)

The Beckhoff Identification Code (BIC) is applied to the outside of Beckhoff products in a visible place. If possible, it should also be electronically readable.

Decisive for the electronic readout is the interface via which the product can be electronically addressed.

K-bus devices (IP20, IP67)

Currently, no electronic storage and readout is planned for these devices.

EtherCAT devices (IP20, IP67)

All Beckhoff EtherCAT devices have a so-called ESI-EEPROM, which contains the EtherCAT identity with the revision number. Stored in it is the EtherCAT slave information, also colloquially known as ESI/XML configuration file for the EtherCAT master. See the corresponding chapter in the EtherCAT system manual ([Link](#)) for the relationships.

The eBIC is also stored in the ESI-EEPROM. The eBIC was introduced into the Beckhoff I/O production (terminals, box modules) from 2020; widespread implementation is expected in 2021.

The user can electronically access the eBIC (if existent) as follows:

- With all EtherCAT devices, the EtherCAT master (TwinCAT) can read the eBIC from the ESI-EEPROM
 - From TwinCAT 3.1 build 4024.11, the eBIC can be displayed in the online view.
 - To do this, check the checkbox "Show Beckhoff Identification Code (BIC)" under EtherCAT → Advanced Settings → Diagnostics:

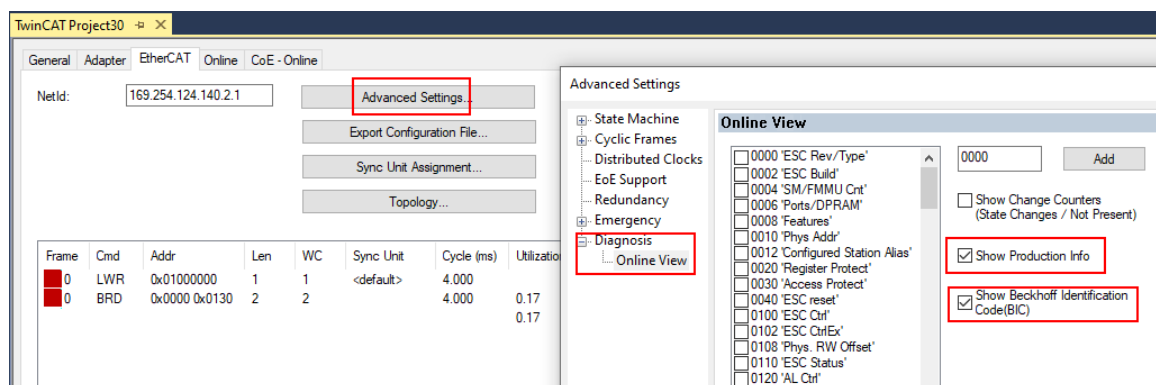

- The BTN and its contents are then displayed:

No	Addr	Name	State	CRC	Fw	Hw	Production Data	ItemNo	BTN	Description	Quantity	BatchNo	SerialNo
1	1001	Term 1 (EK1100)	OP	0.0	0	0	---						
2	1002	Term 2 (EL1018)	OP	0.0	0	0	2020 KW36 Fr	072222	k4p562d7	EL1809	1		678294
3	1003	Term 3 (EL3204)	OP	0.0	7	6	2012 KW24 Sa						
4	1004	Term 4 (EL2004)	OP	0.0	0	0	---	072223	k4p562d7	EL2004	1		678295
5	1005	Term 5 (EL1008)	OP	0.0	0	0	---						
6	1006	Term 6 (EL2008)	OP	0.0	0	12	2014 KW14 Mo						
7	1007	Term 7 (EK1110)	OP	0	1	8	2012 KW25 Mo						

- Note: as can be seen in the illustration, the production data HW version, FW version and production date, which have been programmed since 2012, can also be displayed with "Show Production Info".
- Access from the PLC: From TwinCAT 3.1. build 4024.24 the functions *FB_EcReadBIC* and *FB_EcReadBTN* are available in the Tc2_EtherCAT Library from v3.3.19.0 for reading into the PLC..
- In the case of EtherCAT devices with CoE directory, the object 0x10E2:01 can additionally be used to display the device's own eBIC; the PLC can also simply access the information here:

- The device must be in PREOP/SAFEOP/OP for access:

Index	Name	Flags	Value
1000	Device type	RO	0x015E1389 (22942601)
1008	Device name	RO	ELM3704-0000
1009	Hardware version	RO	00
100A	Software version	RO	01
100B	Bootloader version	RO	J0.1.27.0
1011:0	Restore default parameters	RO	> 1 <
1018:0	Identity	RO	> 4 <
10E2:0	Manufacturer-specific Identification C...	RO	> 1 <
10E2:01	SubIndex 001	RO	1P158442SBTN0008jckp1KELM3704 Q1 2P482001000016
10F0:0	Backup parameter handling	RO	> 1 <
10F3:0	Diagnosis History	RO	> 21 <
10F8	Actual Time Stamp	RO	0x170bfb277e

- The object 0x10E2 will be introduced into stock products in the course of a necessary firmware revision.
- From TwinCAT 3.1. build 4024.24 the functions *FB_EcCoEReadBIC* and *FB_EcCoEReadBTN* are available in the *Tc2_EtherCAT Library* from v3.3.19.0 for reading into the PLC.
- For processing the BIC/BTN data in the PLC, the following auxiliary functions are available in *Tc2_Uilities* from TwinCAT 3.1 build 4024.24 onwards
 - *F_SplitBIC*: The function splits the Beckhoff Identification Code (BIC) *sBICValue* into its components based on known identifiers and returns the recognized partial strings in a structure *ST_SplitBIC* as return value.
 - *BIC_TO_BTN*: The function extracts the BTN from the BIC and returns it as a value.
- Note: in the case of electronic further processing, the BTN is to be handled as a string(8); the identifier "SBTN" is not part of the BTN.
- Technical background
 The new BIC information is additionally written as a category in the ESI-EEPROM during the device production. The structure of the ESI content is largely dictated by the ETG specifications, therefore the additional vendor-specific content is stored with the help of a category according to ETG.2010. ID 03 indicates to all EtherCAT masters that they must not overwrite these data in case of an update or restore the data after an ESI update.
 The structure follows the content of the BIC, see there. This results in a memory requirement of approx. 50..200 bytes in the EEPROM.
- Special cases
 - If multiple, hierarchically arranged ESCs are installed in a device, only the top-level ESC carries the eBIC Information.
 - If multiple, non-hierarchically arranged ESCs are installed in a device, all ESCs carry the eBIC Information.
 - If the device consists of several sub-devices with their own identity, but only the top-level device is accessible via EtherCAT, the eBIC of the top-level device is located in the CoE object directory 0x10E2:01 and the eBICs of the sub-devices follow in 0x10E2:nn.

PROFIBUS, PROFINET, DeviceNet devices etc.

Currently, no electronic storage and readout is planned for these devices.

10.5 Support and Service

Beckhoff and their partners around the world offer comprehensive support and service, making available fast and competent assistance with all questions related to Beckhoff products and system solutions.

Beckhoff's branch offices and representatives

Please contact your Beckhoff branch office or representative for local support and service on Beckhoff products!

The addresses of Beckhoff's branch offices and representatives round the world can be found on her internet pages: www.beckhoff.com

You will also find further documentation for Beckhoff components there.

Support

The Beckhoff Support offers you comprehensive technical assistance, helping you not only with the application of individual Beckhoff products, but also with other, wide-ranging services:

- support
- design, programming and commissioning of complex automation systems
- and extensive training program for Beckhoff system components

Hotline: +49 5246 963 157
e-mail: support@beckhoff.com
web: www.beckhoff.com/support

Service

The Beckhoff Service Center supports you in all matters of after-sales service:

- on-site service
- repair service
- spare parts service
- hotline service

Hotline: +49 5246 963 460
e-mail: service@beckhoff.com
web: www.beckhoff.com/service

Headquarters Germany

Beckhoff Automation GmbH & Co. KG

Hülshorstweg 20
33415 Verl
Germany

Phone: +49 5246 963 0
e-mail: info@beckhoff.com
web: www.beckhoff.com

Beckhoff Automation GmbH & Co. KG
Hülshorstweg 20
33415 Verl
Germany
Phone: +49 5246 9630
info@beckhoff.com
www.beckhoff.com