

Documentation | EN

EP3632-0001

2-channel interface for Condition Monitoring (IEPE), 16 bit



Table of contents

1 Foreword	5
1.1 Notes on the documentation	5
1.2 Safety instructions	6
1.3 Documentation issue status	7
2 EtherCAT Box - Introduction	8
3 Product overview	10
3.1 Introduction	10
3.2 Technical data	11
3.3 Scope of supply.....	13
3.4 Basic function principles.....	14
3.4.1 Vibration analysis	14
3.4.2 Application of condition monitoring	15
3.4.3 Output signals of IEPE sensors	15
3.4.4 Basic principles of IEPE technology.....	17
4 Mounting and cabling	20
4.1 Mounting	20
4.1.1 Dimensions	20
4.1.2 Fixing.....	21
4.1.3 Nut torque for connectors.....	21
4.2 Cabling	22
4.2.1 EtherCAT	22
4.2.2 Supply voltages.....	24
4.2.3 Signal connection.....	27
4.3 UL Requirements	28
4.4 Disposal	29
5 Commissioning/Configuration	30
5.1 Integrating into a TwinCAT project.....	30
5.2 Oversampling terminals/box modules and TwinCAT Scope	31
5.2.1 TwinCAT 3 procedure	32
5.2.2 TwinCAT 2 procedure	41
5.3 Commissioning.....	50
5.4 Application example	55
5.5 Error descriptions and troubleshooting	56
5.6 Restore the delivery state	57
6 CoE parameters	58
6.1 Profile-specific and parameterization objects.....	58
6.1.1 Restore object.....	58
6.1.2 Configuration data.....	59
6.1.3 Command object.....	60
6.1.4 Input data	60
6.1.5 Information / diagnosis data (device-specific).....	61
6.2 Standard objects and PDO mapping.....	61
7 Appendix	79

7.1	General operating conditions	79
7.2	Accessories	80
7.3	Notices on analog specifications	81
7.3.1	Full scale value (FSV), output end value	81
7.3.2	Measurement error/measurement deviation/measurement uncertainty, output uncertainty	81
7.3.3	Temperature coefficient tK [ppm/K].....	82
7.3.4	Long-term use	84
7.3.5	Ground reference: single-ended/differential typification.....	84
7.3.6	Common-mode voltage and reference ground (based on differential inputs).....	89
7.3.7	Dielectric strength	90
7.3.8	Temporal aspects of analog/digital or digital/analog conversion.....	91
7.3.9	Explanation of the term GND/Ground	94
7.3.10	Sampling type: Simultaneous vs. multiplexed.....	96
7.4	Version identification of EtherCAT devices	99
7.4.1	General notes on marking.....	99
7.4.2	Version identification of EP/EPI/EPP/ER/ERI boxes.....	100
7.4.3	Beckhoff Identification Code (BIC).....	101
7.4.4	Electronic access to the BIC (eBIC).....	103
7.5	Support and Service.....	105

1 Foreword

1.1 Notes on the documentation

Intended audience

This description is only intended for the use of trained specialists in control and automation engineering who are familiar with the applicable national standards.

It is essential that the documentation and the following notes and explanations are followed when installing and commissioning these components.

It is the duty of the technical personnel to use the documentation published at the respective time of each installation and commissioning.

The responsible staff must ensure that the application or use of the products described satisfy all the requirements for safety, including all the relevant laws, regulations, guidelines and standards.

Disclaimer

The documentation has been prepared with care. The products described are, however, constantly under development.

We reserve the right to revise and change the documentation at any time and without prior announcement.

No claims for the modification of products that have already been supplied may be made on the basis of the data, diagrams and descriptions in this documentation.

Trademarks

Beckhoff®, TwinCAT®, TwinCAT/BSD®, TC/BSD®, EtherCAT®, EtherCAT G®, EtherCAT G10®, EtherCAT P®, Safety over EtherCAT®, TwinSAFE®, XFC®, XTS® and XPlanar® are registered trademarks of and licensed by Beckhoff Automation GmbH. Other designations used in this publication may be trademarks whose use by third parties for their own purposes could violate the rights of the owners.

Patent Pending

The EtherCAT Technology is covered, including but not limited to the following patent applications and patents: EP1590927, EP1789857, EP1456722, EP2137893, DE102015105702 with corresponding applications or registrations in various other countries.



EtherCAT® is registered trademark and patented technology, licensed by Beckhoff Automation GmbH, Germany.

Copyright

© Beckhoff Automation GmbH & Co. KG, Germany.

The reproduction, distribution and utilization of this document as well as the communication of its contents to others without express authorization are prohibited.

Offenders will be held liable for the payment of damages. All rights reserved in the event of the grant of a patent, utility model or design.

1.2 Safety instructions

Safety regulations

Please note the following safety instructions and explanations!
Product-specific safety instructions can be found on following pages or in the areas mounting, wiring, commissioning etc.

Exclusion of liability

All the components are supplied in particular hardware and software configurations appropriate for the application. Modifications to hardware or software configurations other than those described in the documentation are not permitted, and nullify the liability of Beckhoff Automation GmbH & Co. KG.

Personnel qualification

This description is only intended for trained specialists in control, automation and drive engineering who are familiar with the applicable national standards.

Description of instructions

In this documentation the following instructions are used.
These instructions must be read carefully and followed without fail!

DANGER

Serious risk of injury!

Failure to follow this safety instruction directly endangers the life and health of persons.

WARNING

Risk of injury!

Failure to follow this safety instruction endangers the life and health of persons.

CAUTION

Personal injuries!

Failure to follow this safety instruction can lead to injuries to persons.

NOTE

Damage to environment/equipment or data loss

Failure to follow this instruction can lead to environmental damage, equipment damage or data loss.



Tip or pointer

This symbol indicates information that contributes to better understanding.

1.3 Documentation issue status

Version	Comment
1.6	<ul style="list-style-type: none"> • Signal connection updated
1.5	<ul style="list-style-type: none"> • Structure update
1.4	<ul style="list-style-type: none"> • Dimensions updated • UL requirements updated
1.3	<ul style="list-style-type: none"> • Front page updated • Scope of delivery added • Graphic "Data flow" added in chapter "Commissioning"
1.2	<ul style="list-style-type: none"> • Update Technical data
1.1.0	<ul style="list-style-type: none"> • Update Technical data • Corrections in chapter CoE object description
1.0.0	<ul style="list-style-type: none"> • Amendments • First release
0.3	<ul style="list-style-type: none"> • Update chapter <i>Mounting and Cabling</i> • Update chapter <i>Commissioning / Configuration</i>
0.2	<ul style="list-style-type: none"> • Update chapter "Basic function principles"
0.1	<ul style="list-style-type: none"> • First preliminary version

Firmware and hardware versions

This documentation refers to the firmware and hardware version that was applicable at the time the documentation was written.

The module features are continuously improved and developed further. Modules having earlier production statuses cannot have the same properties as modules with the latest status. However, existing properties are retained and are not changed, so that older modules can always be replaced with new ones.

The firmware and hardware version (delivery state) can be found in the batch number (D-number) printed on the side of the EtherCAT Box.

Syntax of the batch number (D-number)

D: WW YY FF HH

WW - week of production (calendar week)

YY - year of production

FF - firmware version

HH - hardware version

Example with D no. 29 10 02 01:

29 - week of production 29

10 - year of production 2010

02 - firmware version 02

01 - hardware version 01

Further information on this topic: [Version identification of EtherCAT devices \[► 99\]](#).

2 EtherCAT Box - Introduction

The EtherCAT system has been extended with EtherCAT Box modules with protection class IP67. Through the integrated EtherCAT interface the modules can be connected directly to an EtherCAT network without an additional Coupler Box. The high-performance of EtherCAT is thus maintained into each module.

The extremely low dimensions of only 126 x 30 x 26.5 mm (h x w x d) are identical to those of the Fieldbus Box extension modules. They are thus particularly suitable for use where space is at a premium. The small mass of the EtherCAT modules facilitates applications with mobile I/O interface (e.g. on a robot arm). The EtherCAT connection is established via screened M8 connectors.

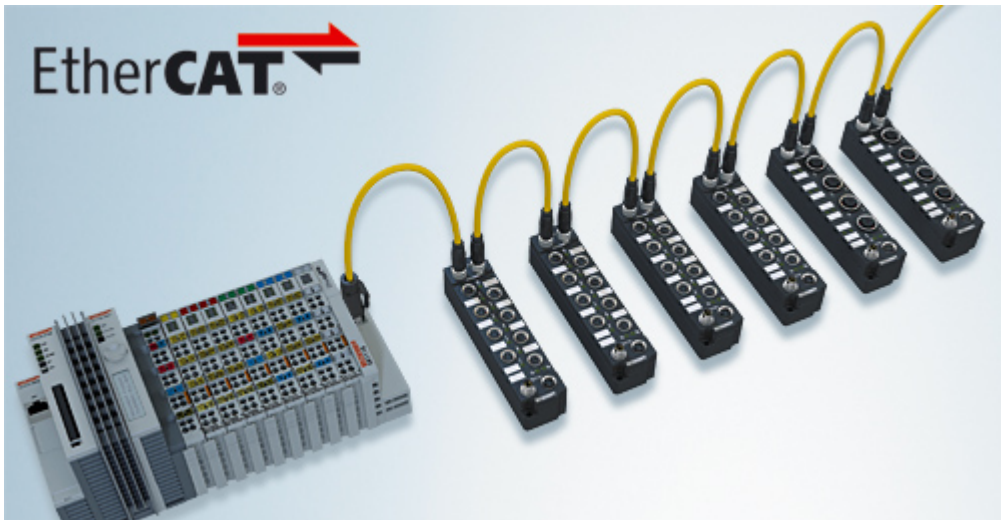

Fig. 1: EtherCAT Box Modules within an EtherCAT network

The robust design of the EtherCAT Box modules enables them to be used directly at the machine. Control cabinets and terminal boxes are now no longer required. The modules are fully sealed and therefore ideally prepared for wet, dirty or dusty conditions.

Pre-assembled cables significantly simplify EtherCAT and signal wiring. Very few wiring errors are made, so that commissioning is optimized. In addition to pre-assembled EtherCAT, power and sensor cables, field-configurable connectors and cables are available for maximum flexibility. Depending on the application, the sensors and actuators are connected through M8 or M12 connectors.

The EtherCAT modules cover the typical range of requirements for I/O signals with protection class IP67:

- digital inputs with different filters (3.0 ms or 10 μ s)
- digital outputs with 0.5 or 2 A output current
- analog inputs and outputs with 16 bit resolution
- Thermocouple and RTD inputs
- Stepper motor modules

XFC (eXtreme Fast Control Technology) modules, including inputs with time stamp, are also available.



Fig. 2: EtherCAT Box with M8 connections for sensors/actuators



Fig. 3: EtherCAT Box with M12 connections for sensors/actuators

● Basic EtherCAT documentation

i You will find a detailed description of the EtherCAT system in the Basic System Documentation for EtherCAT, which is available for download from our website (www.beckhoff.com) under Downloads.

3 Product overview

3.1 Introduction

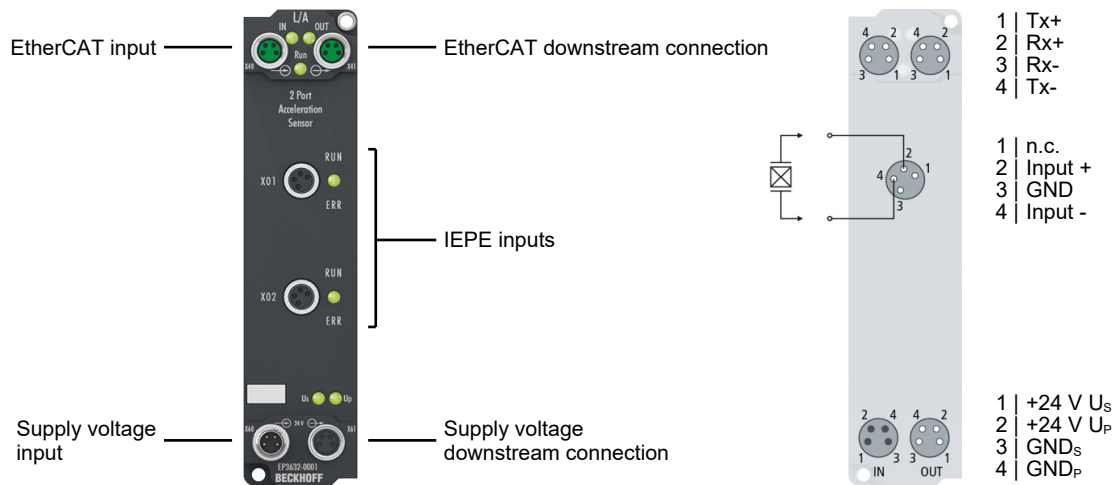

The EP3632 EtherCAT Box is a two-channel oversampling interface for up to two IEPE sensors with two-wire connection. The current of the integrated constant current source can be set separately to 2 mA, 4 mA or 8 mA for each channel depending on the sensor and cable length.

The input signal is sampled according to the oversampling principle with up to 50 kSamples per channel and second. Distributed clocks allow the measured values to be related to other parts of the plant. Except for filtering no preprocessing of the vibration amplitude values takes place in the EP3632. This is handled by the retrieving controller. The interface can be adapted to the application-specific requirements by means of adjustable filters and supply currents.

The TwinCAT 3 Condition Monitoring library offers extensive algorithms for evaluating the signals in the controller, so that the performance and flexibility advantages of the PC platform can be fully exploited.

Quick links

[Technical data \[► 11\]](#)

[Dimensions \[► 20\]](#)

[Signal connection \[► 27\]](#)

3.2 Technical data

All values are typical values over the entire temperature range, unless stated otherwise.

EtherCAT	
Connection	2 x M8 socket, 4-pin, green
Electrical isolation	500 V
Distributed Clocks	yes

Supply voltages	
Connection	Input: M8 connector, 4-pin Downstream connection: M8 socket, 4-pin, black
U_S nominal voltage	24 V _{DC} (-15 % / +20 %)
U_S sum current: $I_{S,sum}$	max. 4 A
Current consumption from U_S	120 mA + IEPE supply current I_{EXCITE}
Rated voltage U_P	24 V _{DC} (-15 % / +20 %)
U_P sum current: $I_{P,sum}$	max. 4 A
Current consumption from U_P	None. U_P is only forwarded.

IEPE	
Number of inputs	2
Connection	2 x M8 socket, four-pin, screwable, shielded
Signal voltage	IEPE constant current supply and acquisition of modulated AC voltage
Sensor state monitoring	yes, through monitoring of the bias voltage
Measuring range	preset ± 5 V up to 25 kHz, ± 250 mV up to 10 Hz
Input filter cut-off frequency	analog parameterizable 5th order low-pass filter up to 25 kHz, typically 0.05 Hz high-pass filter
Measurement uncertainty	< ± 0.5 % (DC, relative to full scale value) See chapter Measurement error/measurement deviation/measurement uncertainty, output uncertainty [► 81] .
Resolution	16 bits (including sign)
Conversion time	20 μ s (max. 50 kSamples/s)
Supply current I_{EXCITE}	2 / 4 / 8 mA (separately adjustable for both channels) from the control voltage U_S
Special features	automatic anti-aliasing function, wire break detection

Housing data	
Dimensions W x H x D	30 mm x 126 mm x 26.5 mm (without connectors)
Weight	approx. 165 g
Installation position	variable
Material	PA6 (polyamide)

Environmental conditions	
Ambient temperature during operation	-25 ... +60 °C -25 ... +55 °C according to cURus
Ambient temperature during storage	-40 ... +85 °C
Vibration resistance, shock resistance	conforms to EN 60068-2-6 / EN 60068-2-27 Additional checks [▶ 12]
EMC immunity / emission	conforms to EN 61000-6-2 / EN 61000-6-4
Protection class	IP65, IP66, IP67 (conforms to EN 60529)

Approvals/markings	
Approvals/markings *)	CE, cURus [▶ 28]

*) Real applicable approvals/markings see type plate on the side (product marking).

Additional tests

The devices have undergone the following additional tests:

Test	Explanation
Vibration	10 frequency sweeps in 3 axes
	5 Hz < f < 60 Hz displacement 0.35 mm, constant amplitude
	60.1 Hz < f < 500 Hz acceleration 5 g, constant amplitude
Shocks	1000 shocks in each direction, in 3 axes
	35 g, 11 ms

3.3 Scope of supply

Make sure that the following components are included in the scope of delivery:

- 1x EtherCAT Box EP3632-0001
- 2x protective cap for EtherCAT socket, M8, green (pre-assembled)
- 1x protective cap for supply voltage input, M8, transparent (pre-assembled)
- 1x protective cap for supply voltage output, M8, black (pre-assembled)
- 10x labels, blank (1 strip of 10)

● Pre-assembled protective caps do not ensure IP67 protection

i Protective caps are pre-assembled at the factory to protect connectors during transport. They may not be tight enough to ensure IP67 protection.

Ensure that the protective caps are correctly seated to ensure IP67 protection.

3.4 Basic function principles

3.4.1 Vibration analysis

Vibration analysis refers to deriving of information from existing (mechanical) vibrations e.g. in machines or certain production processes. It can take place during Condition Monitoring, e.g. for drives, punching and pressing tools, in production processes such as balancing of rotating parts, or during other movements such as torsion of towers/wind turbines.

The table below illustrates typical acceleration values for natural and technical processes.

Typical acceleration values

Machine or event	Typical g-value
Commercial aircraft (take-off)	≈ 0,5
Formula 1 car (start)	≈ 1 – 1,5
Commercial aircraft (turning, max.)	≈ 2,5
Pendulum at 90° amplitude	≈ 2
Space Shuttle during journey into orbit	max. 3 (exact)
Space Shuttle during re-entry into the Earth's atmosphere	max. 1.6
Typical roller coaster ride (max.)	4 (6)
Formula 1 car (cornering, max.)	≈ 4 – 5
Circular looping (base)	≥ 6
Combat aircraft/aerobatics (max.)	≈ 10 (13,8)
Ejector seat	15 – 20
Car back-rest breaks at	≈ 20
Head-on car collision	up to ≈ 50
Car passenger compartment during crash	max. 120
Survived by a human	≈ 180
Hard fist stroke	up to ≈ 100
Raindrop hitting the eye	up to ≈ 150
Ball pen hitting hard floor from 1 m height	order of magnitude 1000
Hard disk falling on hard floor from 1 m height (without deformation of the floor)	10,000 or more
Laboratory centrifuge	≈ 10.000
Ultra centrifuge	≈ 100.000
Rifle bullet during firing	≈ 100.000
Spike during ejection from a nettle cell	5.410.000
Nuclear bomb explosion (bomb case)	up to ≈ 10 ¹¹
Neutron star surface	≈ 2·10 ¹¹

3.4.2 Application of condition monitoring

Condition monitoring can be used to glean information on the state of rotating/moving parts through measurement of vibrations at machines/drives/gears and subsequent analysis with suitable mathematical tools (e.g. TwinCAT library, FFT, custom user programs).

The existing vibration is recorded continuously or at longer, regular time intervals and finally compared with a setpoint value/initial value (Fig. *Sample of ball bearing damage and subsequent analysis*).

In this way any damage can be detected at an early stage. Instead of changing components preventively on a regular basis or waiting for sudden damage and subsequent expensive downtime and possible consequential damage, repairs and downtimes become plannable. Needless failures, consequential damage or prematurely and costly replacement of intact parts can be avoided.

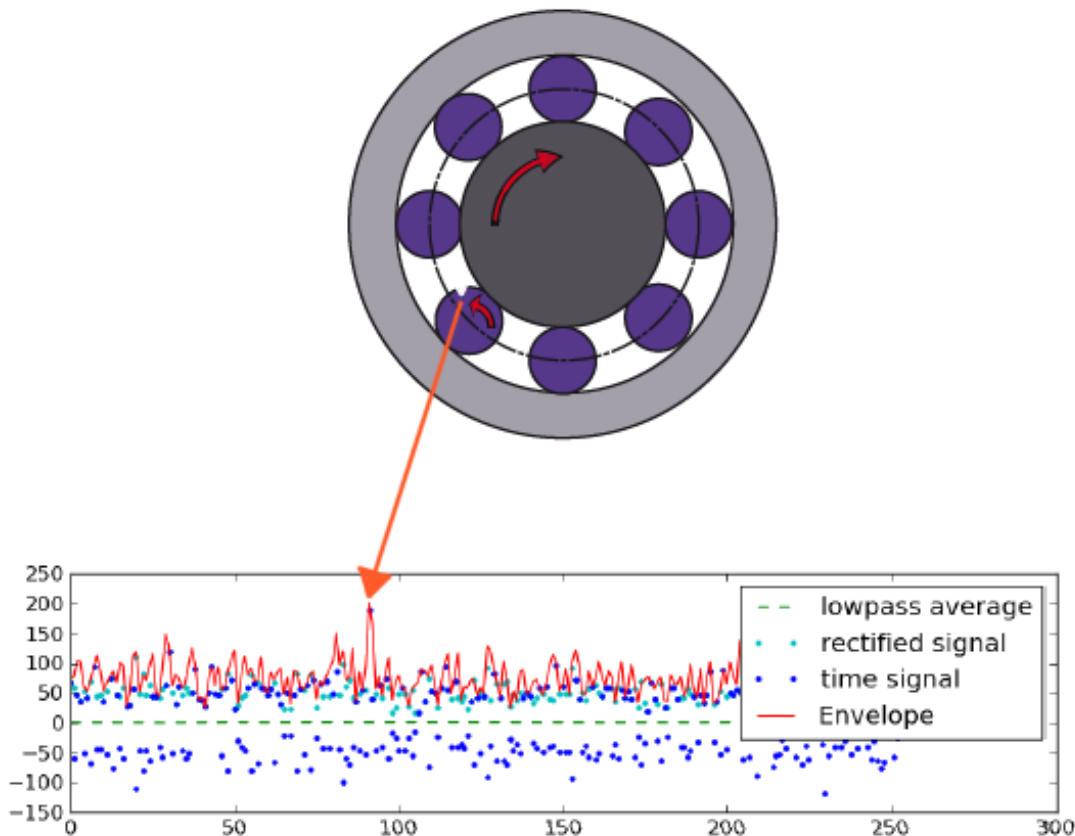

Fig. 4: Example of ball bearing damage and subsequent analysis

In the example above the so-called envelope enables analysis of shock pulses resulting from unevenness in the roller bearing. The defective element can be identified based on the periodicity (envelope spectrum).

3.4.3 Output signals of IEPE sensors

Vibrations can be recorded with IEPE (Integrated Electronics Piezo Electric) sensors, for example. The advantage of this technology is an integrated amplifier as impedance transformer, so that only a simple two-wire connection (coax) is required for the low-impedance output signal. IEPE sensors are typically supplied with 2...20 mA constant current. In inactive state they produce a constant DC bias voltage (zero voltage/ U_{bias}) typically 7...14 V. Depending on the acceleration of the sensor, an analog AC voltage generated proportionally to the movement is added to the sensor's U_{bias} ; e.g. a 50 Hz sinusoidal deflection with an amplitude of 1 g ($= 9.81 \text{ m/s}^2$) produces a 50 Hz sinusoidal output voltage of AC $\pm 50 \text{ mV} + U_{\text{bias}}$ in the case of a sensor with a sensitivity of 50 mV/g (Fig. *Output signal of an IEPE sensor (sample)*). The maximum output signal of a sensor is usually AC $\pm 5 \text{ V} (+ U_{\text{bias}})$.

Increasing cable length results in increasing cable capacitance (typically 100 pF/m), so that the control capability of the integrated amplifier drops with increasing signal frequency. This can be partly compensated by increasing the supply current (Fig. *Control capability of the IEPE impedance transformer depending on cable capacitance and supply current*).

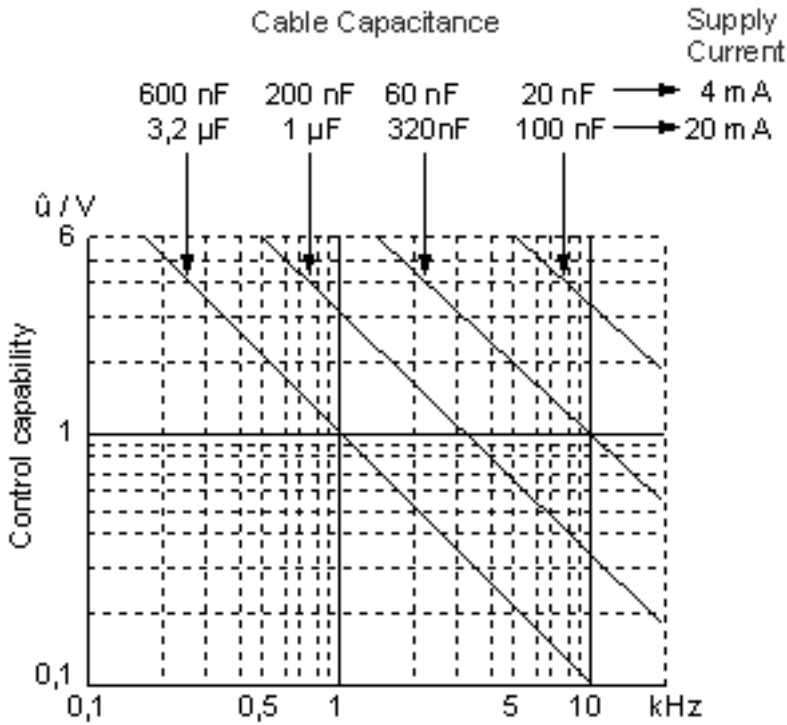

Fig. 5: Control capability of the IEPE impedance transformer depending on cable capacitance and supply current.

The basic properties of IEPE acceleration sensors are described by various parameters such as sensitivity (e.g. 50 mV/g), measuring range (e.g. +/-100 g), +/-3 dB frequency range (under 1 Hz to several kHz), current consumption (2...20 mA), bias voltage etc. The figure *Frequency response of an acceleration sensor* shows an example of a frequency response (amplitude of the output signal in relation to the frequency).

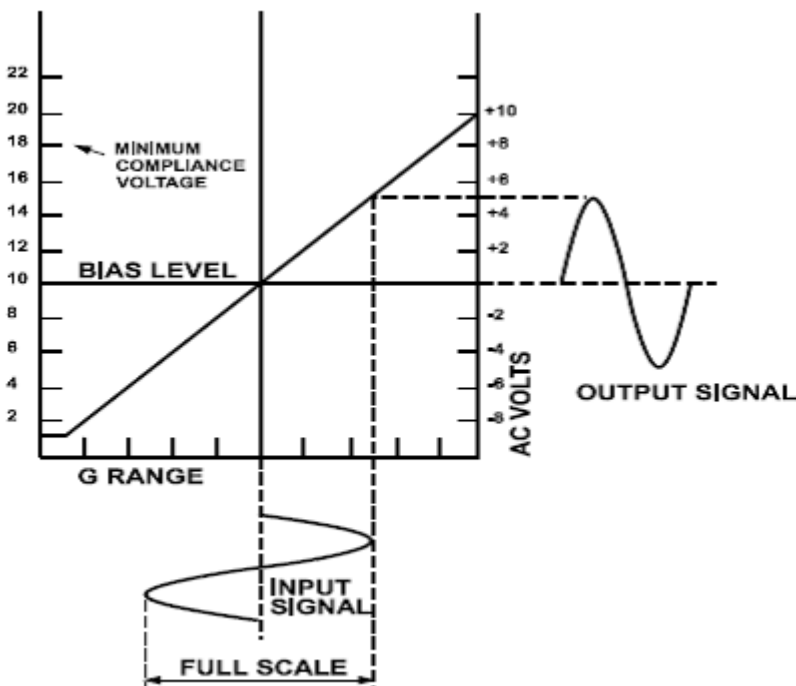

Fig. 6: Output signal of an IEPE sensor (sample)

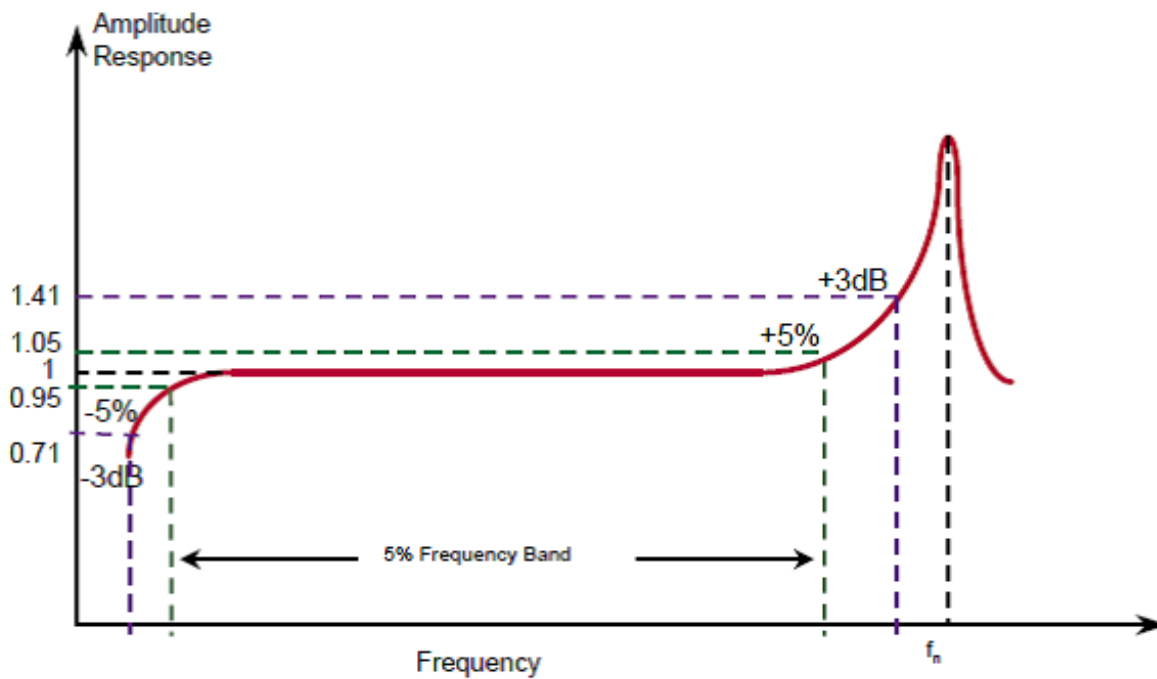

Fig. 7: Frequency response of an acceleration sensor

Other proprietary names for this electrical technique include DeltaTron®, Isotron™, ICP™, Piezotron™ or CCLD

Note: At their core IEPE sensors usually have quartz crystals, which experience small charge changes due to the motion. Measuring and transporting these over several meters requires complex cable installations and measuring instruments for charge amplification. For cost-effective and robust application in industrial environments the solution is to integrate a simple charge amplifier as impedance transformer in the sensor. This enables it to generate the above-mentioned voltage signal and transport the vibration information over larger distance (several tens of meters).

3.4.4 Basic principles of IEPE technology

IEPE ("Integrated Electronics Piezo-Electric") is the standardized name for an analog electrical interface between piezoelectric sensors and electronic analysis equipment. Different manufacturers have developed their own brand names, such as ICP®, CCLD®, Isotron®, DeltaTron®, Piezotron®.

Application

Piezoelectric sensors are usually based on a quartz, in which an electrical charge is shifted under mechanical load. The charge can be detected as a voltage if the measurement is made with sufficiently high impedance. The measurement is a preferably static process, which must take place within a much smaller time interval than 10 seconds, since otherwise the charge difference is dissipated through external or internal derivatives. Such a sensor is therefore less suitable for static long-term loads, such as weighing a silo. Such sensors tend to be used for all kinds of predominantly higher frequency vibration measurements (unbalance detection, sound signals via microphones up to ultrasound, mechanical vibrations, foundation monitoring, etc.).

Over the decades, two electrical forms of interfaces to the evaluation unit have developed:

- Direct charge output
- IEPE output

Charge output

The sensor's output signal is provided by a very low change of charge (usually in the range of a little femto to pico coulomb) and tapped by a (possibly short) 2-wire cable. Thus a so called charge amplifier is an essential component of the measurement electronics.

Advantages: the sensor can be exposed to high temperatures over 150 °C; no power supply is required.

Disadvantages: very sensitive to external influences on the cable (line length, possible movement of the cable, type of cable and shielding, electromagnetic fields, etc.); elaborate receiving electronics and cable due to high source impedance.

IEPE output

Since the charging output interface is not generally accepted for industrial applications, a more robust transfer method was sought at an early stage. Thus, for IEPE integrates a field effect transistor (FET) directly at the output of the sensor.

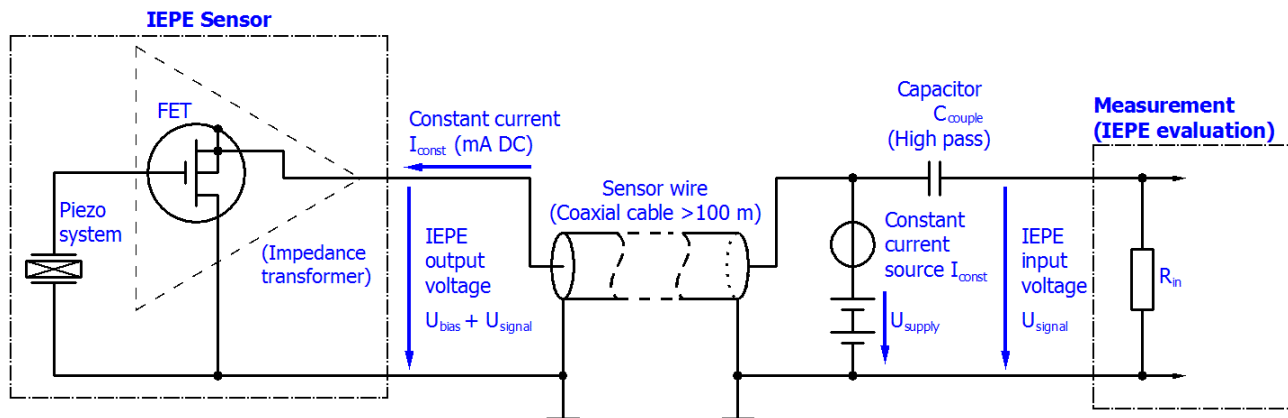

If this sensor is supplied with constant current between 2 and 8 mA via the two-pole cable, the resulting bias voltage is usually approx. 8 to 15 V. If the piezo system is now directly or indirectly (e.g. by a diaphragm) loaded by a measure quantity e.g. force in form of pressure or acceleration, the FET changes its channel resistance caused by change of charge amount on its gate; according to this, a change of the gate source voltage. Because of the supply of I_{const} by a constant current source, the bias voltage changes correspondingly by the mechanical load of about few volts. Although the evaluation unit now usually has to provide the constant current supply but is able to deduce the measurement quantity by the back-measured voltage.

Advantages: robust system, which is suitable for operation in industrial conditions.

Disadvantages: upper temperature limit for the sensor 150 to 200 °C, smaller dynamic range.

Notes on constant current

- The higher the feed current, the more the vibration sensor heats up. This may cause a disadvantageous effect on e.g. the basic accuracy of the sensor. For this, note the information provided by the sensor manufacturer.
- The higher the feed current, the higher the maximum transferable signal frequency, since charge inflows and outflows can be balanced more quickly on the cable.
- The higher the supply current, the higher the resulting bias voltage. As a result, the transfer may become more robust against electromagnetic influence, but on the other hand that for large amplitudes the measurement quantity may enter the upper saturation faster.

Notes on the IEPE measuring device

- In some IEPE measuring devices the supply current can be switched off (0 mA), so that they can be used for voltage measurements, cf. for example Beckhoff ELM3604
- Since normally only AC signals are of interest in the vibration range, IEPE evaluations have an electrical high-pass with a cutoff frequency of approximately 10 Hz on the input side. Depending on the application e.g. the capturing of slow tower vibrations, the limit of this high-pass may be relevant, cf. for example the configurable high-pass of the ELM3604, which can be switched off.

- The bias voltage is suitable for detection of wire breakage or short circuit cases respectively, e.g. see also ELM3604 diagnostics options.

Notes on the IEPE sensor

- If IEPE sensors are mounted on high-voltage or frequency converter-controlled motors, an electrically insulated installation or an insulated sensor may be recommendable. In other cases, interference effects on the IEPE measurement have already been observed. This purely functional consideration must be weighed up by the plant installer against normative and electrical safety requirements.

Purposeful questions for the successful commissioning of an IEPE sensor

The following questions can be used to select the sensor and evaluation device (Beckhoff Terminal/Box) to suit the task:

1. The target frequency range of interest for the task must be specified
2. Is a small-scale or widely distributed system planned?
Especially in the 2nd case it can be useful to select so called isolated sensors to avoid hum/ground loops and signal noise
3. What amplitude accuracy is required?
The frequency behavior of a common IEPE sensor is characterized by significant amplitude errors at the bottom (< 1 kHz) as well as at the top (> 5 kHz)! See manufacturer's data. The appropriate sensor must then be selected from the target frequency range and the maximum permissible amplitude error (of the sensor). For example, with max. 5% amplitude error (corresponds to 5000 ppm, approx. -0.5 dB) a sensor in the range 2 ... 4400 Hz could be trustworthy, i.e. frequencies outside this range (which are transmitted!) must be filtered out on the device side.
4. Which mounting method to select (screwed, magnet, glued, ...).
The type of mounting has a considerable influence on the maximum frequency that can be transmitted! Resonances occur, see the instructions of the sensor manufacturers, also here the maximum permissible amplitude error on the system side must be applied.
For example, it could turn out that a sensor is only trustworthy up to 4 kHz, and frequencies above this would also have to be filtered out on the device side.
5. IEPE sensors are subject to a temperature dependency according to the data sheet!
6. What is the maximum acceleration expected? For this purpose, the required supply current must be determined as a function of the cable length.
7. The evaluation device should now be selected to match the key data determined above.
8. The appropriate sampling rate/oversampling, high-pass and low-pass filters must then be set in the configuration/commissioning.

4 Mounting and cabling

4.1 Mounting

4.1.1 Dimensions

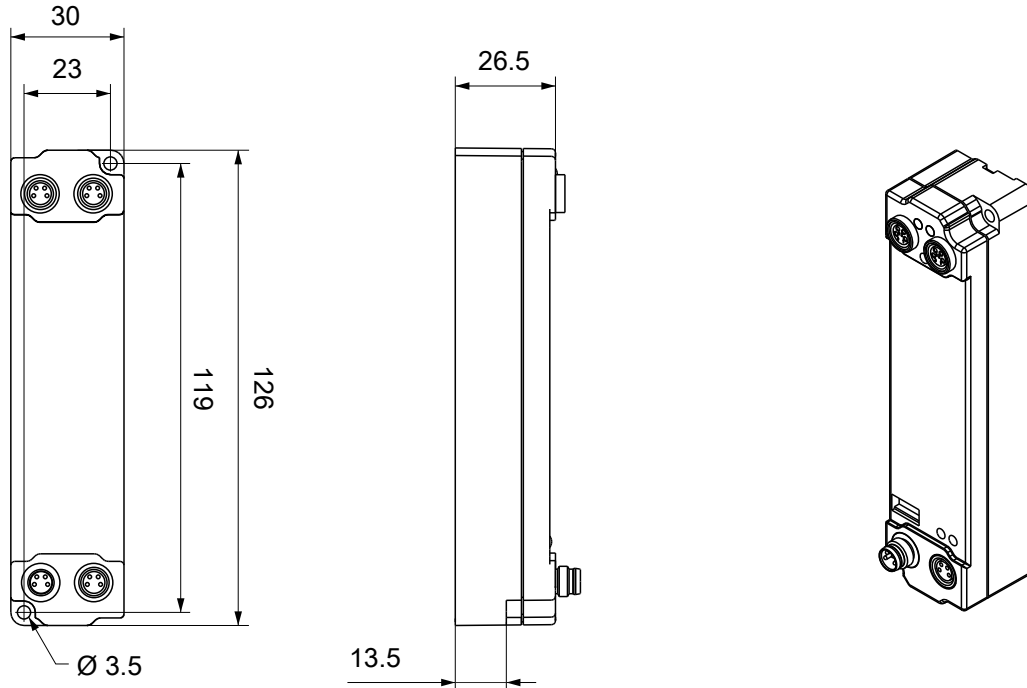

All dimensions are given in millimeters.
The drawing is not true to scale.

Housing features

Housing material	PA6 (polyamide)
Sealing compound	polyurethane
Mounting	two mounting holes $\varnothing 3.5$ mm for M3
Metal parts	brass, nickel-plated
Contacts	CuZn, gold-plated
Power feed through	max. 4 A
Installation position	variable
Protection class	IP65, IP66, IP67 (conforms to EN 60529) when screwed together
Dimensions (H x W x D)	approx. 126 x 30 x 26.5 mm (without connectors)

4.1.2 Fixing

NOTE

Dirt during assembly

Dirty connectors can lead to malfunctions. Protection class IP67 can only be guaranteed if all cables and connectors are connected.

- Protect the plug connectors against dirt during the assembly.

Mount the module with two M3 screws on the mounting holes in the corners of the module. The mounting holes have no thread.

4.1.3 Nut torque for connectors

Screw M8 connectors tight with a torque wrench. (e.g. ZB8801 from Beckhoff)

Torque: 0.4 Nm.

4.2 Cabling

4.2.1 EtherCAT

4.2.1.1 Connectors

NOTE
<p>Risk of confusion: supply voltages and EtherCAT</p> <p>Defect possible through incorrect insertion.</p> <ul style="list-style-type: none"> Observe the color coding of the connectors: black: Supply voltages green: EtherCAT

EtherCAT Box Modules have two green M8 sockets for the incoming and downstream EtherCAT connections.



Connection

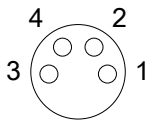

Fig. 8: M8 socket

EtherCAT	M8 connector	Core colors		
Signal	Contact	ZB9010, ZB9020, ZB9030, ZB9032, ZK1090-6292, ZK1090-3xxx-xxxx	ZB9031 and old versions of ZB9030, ZB9032, ZK1090-3xxx-xxxx	TIA-568B
Tx +	1	yellow ¹⁾	orange/white	white/orange
Tx -	4	orange ¹⁾	orange	orange
Rx +	2	white ¹⁾	blue/white	white/green
Rx -	3	blue ¹⁾	blue	green
Shield	Housing	Shield	Shield	Shield

¹⁾ Core colors according to EN 61918

i Adaptation of core colors for cables ZB9030, ZB9032 and ZK1090-3xxxx-xxxx

For standardization, the core colors of the ZB9030, ZB9032 and ZK1090-3xxx-xxxx cables have been changed to the EN61918 core colors: yellow, orange, white, blue. So there are different color codes in circulation. The electrical properties of the cables have been retained when the core colors were changed.

4.2.1.2 Status LEDs



L/A (Link/Act)

A green LED labelled "L/A" is located next to each EtherCAT socket. The LED indicates the communication state of the respective socket:

LED	Meaning
off	no connection to the connected EtherCAT device
lit	LINK: connection to the connected EtherCAT device
flashes	ACT: communication with the connected EtherCAT device

Run

Each EtherCAT slave has a green LED labelled "Run". The LED signals the status of the slave in the EtherCAT network:

LED	Meaning
off	Slave is in "Init" state
flashes uniformly	Slave is in "Pre-Operational" state
flashes sporadically	Slave is in "Safe-Operational" state
lit	Slave is in "Operational" state

Description of the EtherCAT slave states

4.2.1.3 Cables

For connecting EtherCAT devices only shielded Ethernet cables that meet the requirements of at least category 5 (CAT5) according to EN 50173 or ISO/IEC 11801 should be used.

EtherCAT uses four wires for signal transmission. Thanks to automatic line detection ("Auto MDI-X"), both symmetrical (1:1) or cross-over cables can be used between Beckhoff EtherCAT.

Detailed recommendations for the cabling of EtherCAT devices

4.2.2 Supply voltages

⚠ WARNING

Power supply from SELV/PELV power supply unit!

SELV/PELV circuits (Safety Extra Low Voltage, Protective Extra Low Voltage) according to IEC 61010-2-201 must be used to supply this device.

Notes:

- SELV/PELV circuits may give rise to further requirements from standards such as IEC 60204-1 et al, for example with regard to cable spacing and insulation.
- A SELV (Safety Extra Low Voltage) supply provides safe electrical isolation and limitation of the voltage without a connection to the protective conductor, a PELV (Protective Extra Low Voltage) supply also requires a safe connection to the protective conductor.

⚠ CAUTION

Observe the UL requirements

- When operating under UL conditions, observe the warnings in the chapter [UL Requirements \[▶ 28\]](#).

The EtherCAT Box has one input for two supply voltages:

- **Control voltage U_s**
The following sub-functions are supplied from the control voltage U_s :
 - the fieldbus
 - the processor logic
 - typically the inputs and the sensors if the EtherCAT Box has inputs.
- **Peripheral voltage U_p**
For EtherCAT Box modules with digital outputs the digital outputs are typically supplied from the peripheral voltage U_p . U_p can be supplied separately. If U_p is switched off, the fieldbus function, the function of the inputs and the supply of the sensors are maintained.

The exact assignment of U_s and U_p can be found in the pin assignment of the I/O connections.

Redirection of the supply voltages

The power IN and OUT connections are bridged in the module. Hence, the supply voltages U_s and U_p can be passed from EtherCAT Box to EtherCAT Box in a simple manner.

NOTE

Note the maximum current!

Ensure that the permitted current for the connectors is not exceeded when routing the supply voltages U_s and U_p :

M8 connector: max. 4 A
7/8" connector: max 16 A

NOTE

Unintentional cancellation of the electrical isolation of GND_s and GND_p possible.

In some types of EtherCAT Box modules the ground potentials GND_s and GND_p are connected.

- If several EtherCAT Box modules are supplied with the same electrically isolated voltages, check whether there is an EtherCAT Box among them in which the ground potentials are connected.

4.2.2.1 Connectors

NOTE

Risk of confusion: supply voltages and EtherCAT

Defect possible through incorrect insertion.

- Observe the color coding of the connectors:
 black: Supply voltages
 green: EtherCAT

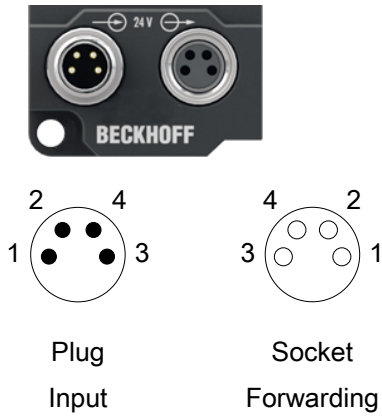

Fig. 9: M8 connector

Contact	Function	Description	Core color ¹⁾
1	U _S	Control voltage	Brown
2	U _P	Peripheral voltage	White
3	GND _S	GND to U _S	Blue
4	GND _P	GND to U _P	Black

¹⁾ The core colors apply to cables of the type: Beckhoff ZK2020-3xxx-xxxx

4.2.2.2 Status LEDs



LED	Display	Meaning
U _S (control voltage)	off	The supply voltage U _S is not available.
	green illuminated	The supply voltage U _S is available.
U _P (peripheral voltage)	off	The supply voltage U _P is not available.
	green illuminated	The supply voltage U _P is available.

4.2.2.3 Conductor losses

Take into account the voltage drop on the supply line when planning a system. Avoid the voltage drop being so high that the supply voltage at the box lies below the minimum nominal voltage. Variations in the voltage of the power supply unit must also be taken into account.

Voltage drop on the supply line

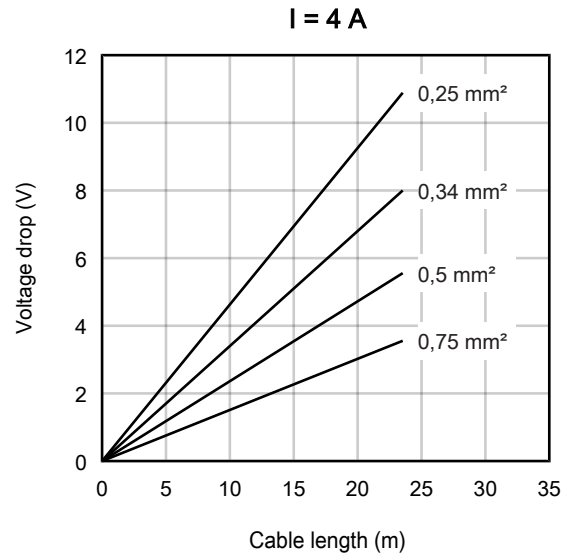
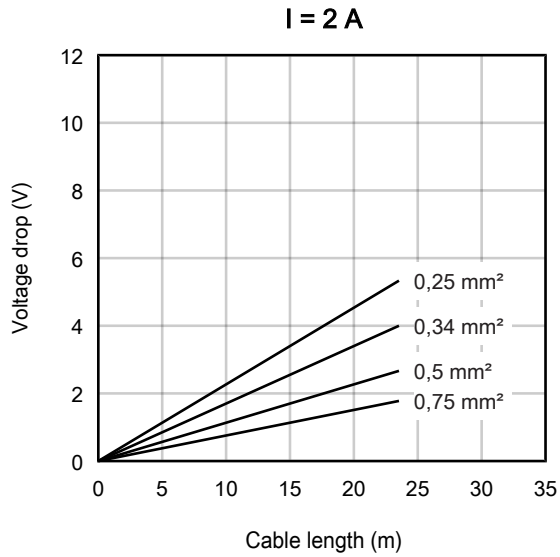

4.2.3 Signal connection

IEPE sensors

The IEPE inputs X01 and X02 are designed as 4-pin M8 sockets.

You can connect an IEPE sensor to each input in the two-wire connection.

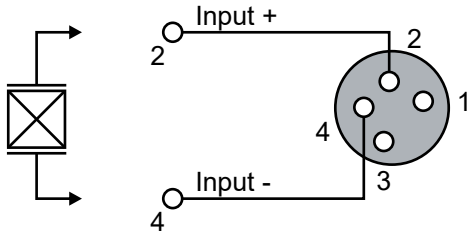

The sleeves of X01 and X02 are internally connected to the EtherCAT shield.

4.2.3.1 LEDs

Meanings on the LEDs



LED	Color	Meaning	
RUN	green	This LED indicates the terminal's operating state	
		off	State of the EtherCAT State Machine: INIT = initialization of the terminal
		flashing	State of the EtherCAT State Machine: PREOP = function for mailbox-communication and different standard-settings set
		Single flash	State of the EtherCAT State Machine: SAFEOP = verification of the Sync-Managers channels and the distributed Clocks. Outputs remain in safe state.
on	State of the EtherCAT State Machine: OP = normal operating state; mailbox- and process data communication is possible		
Error 1/2	red	Open circuit error	

4.3 UL Requirements

The installation of the EtherCAT Box Modules certified by UL has to meet the following requirements.

Supply voltage

⚠ CAUTION

CAUTION!

This UL requirements are valid for all supply voltages of all marked EtherCAT Box Modules!
For the compliance of the UL requirements the EtherCAT Box Modules should only be supplied

- by a 24 V_{DC} supply voltage, supplied by an isolating source and protected by means of a fuse (in accordance with UL248), rated maximum 4 Amp, or
- by a 24 V_{DC} power source, that has to satisfy *NEC class 2*.
A *NEC class 2* power supply shall not be connected in series or parallel with another (class 2) power source!

⚠ CAUTION

CAUTION!

To meet the UL requirements, the EtherCAT Box Modules must not be connected to unlimited power sources!

Networks

⚠ CAUTION

CAUTION!

To meet the UL requirements, EtherCAT Box Modules must not be connected to telecommunication networks!

Ambient temperature range

⚠ CAUTION

CAUTION!

To meet the UL requirements, EtherCAT Box Modules has to be operated only at an ambient temperature range of -25 °C to +55 °C!

Marking for UL

All EtherCAT Box Modules certified by UL (Underwriters Laboratories) are marked with the following label.



Fig. 10: UL label

4.4 Disposal



Products marked with a crossed-out wheeled bin shall not be discarded with the normal waste stream. The device is considered as waste electrical and electronic equipment. The national regulations for the disposal of waste electrical and electronic equipment must be observed.

5 Commissioning/Configuration

5.1 Integrating into a TwinCAT project

The procedure for integration in a TwinCAT project is described in these [Quick start guide](#).

5.2 Oversampling terminals/box modules and TwinCAT Scope

Generally, input data of a terminal/box could be achieved by the scope either directly (via the activated ADS server) or by creation of a PLC variable which is linked to the PDO of a terminal/box for recording them. Both procedures will be explained for TwinCAT 3 (TC3) at first and for TwinCAT 2 (TC2) respectively.

Oversampling means that an analog or digital input device supplies not only one measured value for each process data cycle/EtherCAT cycle (duration T), but several, which are determined at a constant interval $t < T$. The ratio T/t is the oversampling factor n.

A channel thus offers not only one PDO for linking in the process data, as in the example here with the EL3102, but n PDOs as in the case of the EL3702 and other oversampling terminals/box modules.

The definition of “oversampling” by the Beckhoff’s point of view shouldn’t be mixed up with the oversampling process of a deltaSigma ADC:

- **deltaSigma ADC:** the frequency used by the ADC to sample the analogue signal is faster than a multiple times than the frequency of the provided digital data (typically in kHz range). This is called oversampling resulting by the functional principle of this converter type and serve amongst others for anti-aliasing.
- **Beckhoff:** the device/ the terminal/box read of the used ADC (could be a deltaSigma ADC also) digital sample data n-times more than the PLC/ bus cycle time is set and transfers every sample to the control – bundled as an oversampling PDO package.

For example, these both procedures are arranged sequentially by their technical implementation within the EL3751 and can also be present simultaneously.

EL3102

Name	Type	Size
⚡↑ Status	Status_4099	2.0
⚡↑ Value	INT	2.0
⚡↑ Status	Status_4099	2.0
⚡↑ Value	INT	2.0

EL3702

Name	Type	Size
⚡↑ Ch1 CycleCount	UINT	2.0
⚡↑ Ch1 Value	INT	2.0
⚡↑ Ch1 Value	INT	2.0
⚡↑ Ch1 Value	INT	2.0
⚡↑ Ch1 Value	INT	2.0
⚡↑ Ch1 Value	INT	2.0
⚡↑ Ch1 Value	INT	2.0
⚡↑ Ch1 Value	INT	2.0
⚡↑ Ch1 Value	INT	2.0
⚡↑ Ch1 Value	INT	2.0
⚡↑ Ch1 Value	INT	2.0
⚡↑ Ch2 CycleCount	UINT	2.0
⚡↑ Ch2 Value	INT	2.0
⚡↑ Ch2 Value	INT	2.0
⚡↑ Ch2 Value	INT	2.0
⚡↑ Ch2 Value	INT	2.0
⚡↑ Ch2 Value	INT	2.0
⚡↑ Ch2 Value	INT	2.0
⚡↑ Ch2 Value	INT	2.0
⚡↑ Ch2 Value	INT	2.0
⚡↑ Ch2 Value	INT	2.0
⚡↑ Ch2 Value	INT	2.0
⚡↑ Ch2 Value	INT	2.0

Fig. 11: Oversampling PDO of the EL37xx series and in the comparison with EL31xx

Accordingly, the Scope2 (TC2) or ScopeView (TC3) can read in and display several PDOs per cycle in correct time.

5.2.1 TwinCAT 3 procedure

From TwinCAT 3.1 build 4012 and using the revision as below specified in the configuration, the integrated ScopeView recognizes in its variable browser that the oversampling data is an array package and activates ForceOversampling automatically. The array as a whole must be selected using *AddSymbol* (see description in the next section). The extended PDO name provides the basis for this. Since a specific revision of the respective terminal ScopeView is able to detect the array type of a set of variables autonomous.

Terminal	Revision
EL4732	all
EL4712	all
EL3783	EL3783-0000-0017
EL3773	EL3773-0000-0019
EL3751	all
EL3742	all
EL3702	all
EL3632	all
EL2262	all
EL1262-0050	all
EL1262	all
EP3632-0001	all
EPP3632-0001	all

Recording a PLC Variable with the TwinCAT 3 – ScopeView

By a precondition of an already created TwinCAT 3 – project and a connected PLC with an oversampling able terminal/box within the configuration it will be illustrated how an oversampling variable can be represented by the Scope (as a standard part of the TwinCAT 3 environment). This will be explained by means of several steps based on an example project “SCOPE_with_Oversampling“ as a standard PLC project.

Step 1: Adding a project „Scope YT“

The example project “SCOPE_with_Oversampling“ has to be added a TwinCAT Measurement – project “Scope YT project” (C) by right click (A) and selection (B) “Add” → “New Project..”. Then “Scope for OS” will be entered as name. The new project just appears within the solution explorer (D).

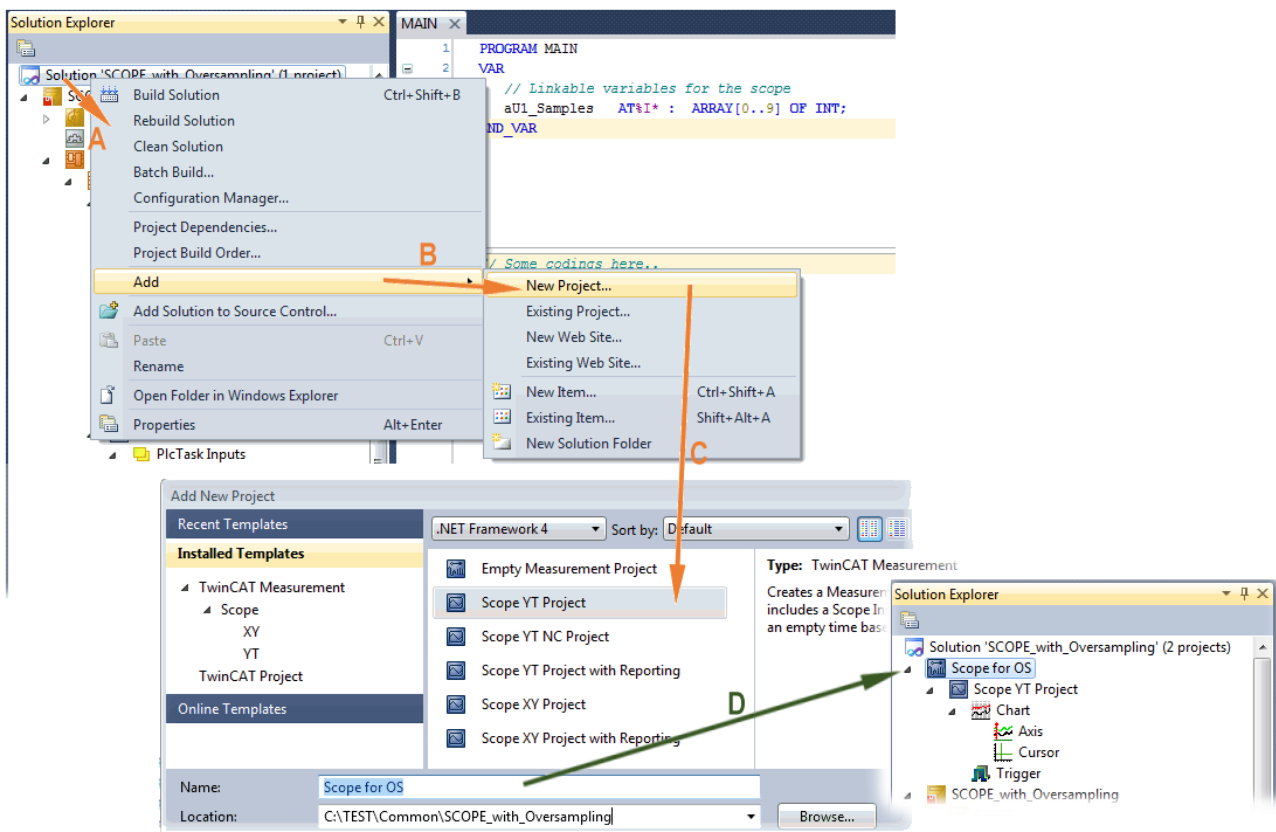

Fig. 12: Adding a Scope project into an already existing project

Step 2a: Creation of a PLC variable within a POU

Within the TwinCAT 3 development environment an input variable as an array with respective amount than is given by the oversampling factor have to be defined at first how it's illustrated in an example for the POU "MAIN" and an oversampling factor 10 with structured text (ST) as follows:

```
PROGRAM MAIN
VAR
  aU1_Samples AT%I* : ARRAY[0..9] OF INT;
END_VAR
```

The identification "AT%I*" stands for swapping out this array variable to link it with the process data objects (PDOs) of a terminal/box later. Notice that at least the number of elements has to be the same as the oversampling factor so that the indices can be set from 0 to 9 also. As soon as the compiling procedure was started and ended successful (in doing so no program code may be present) the array appears into the solution explorer of the TwinCAT 3 development environment within the section PLC under "..Instance".

The following illustration shows extracts of the solution explorer on the right. As an example that linking of an array variable to a set of oversampling process data of an EL3773 is represented herewith:

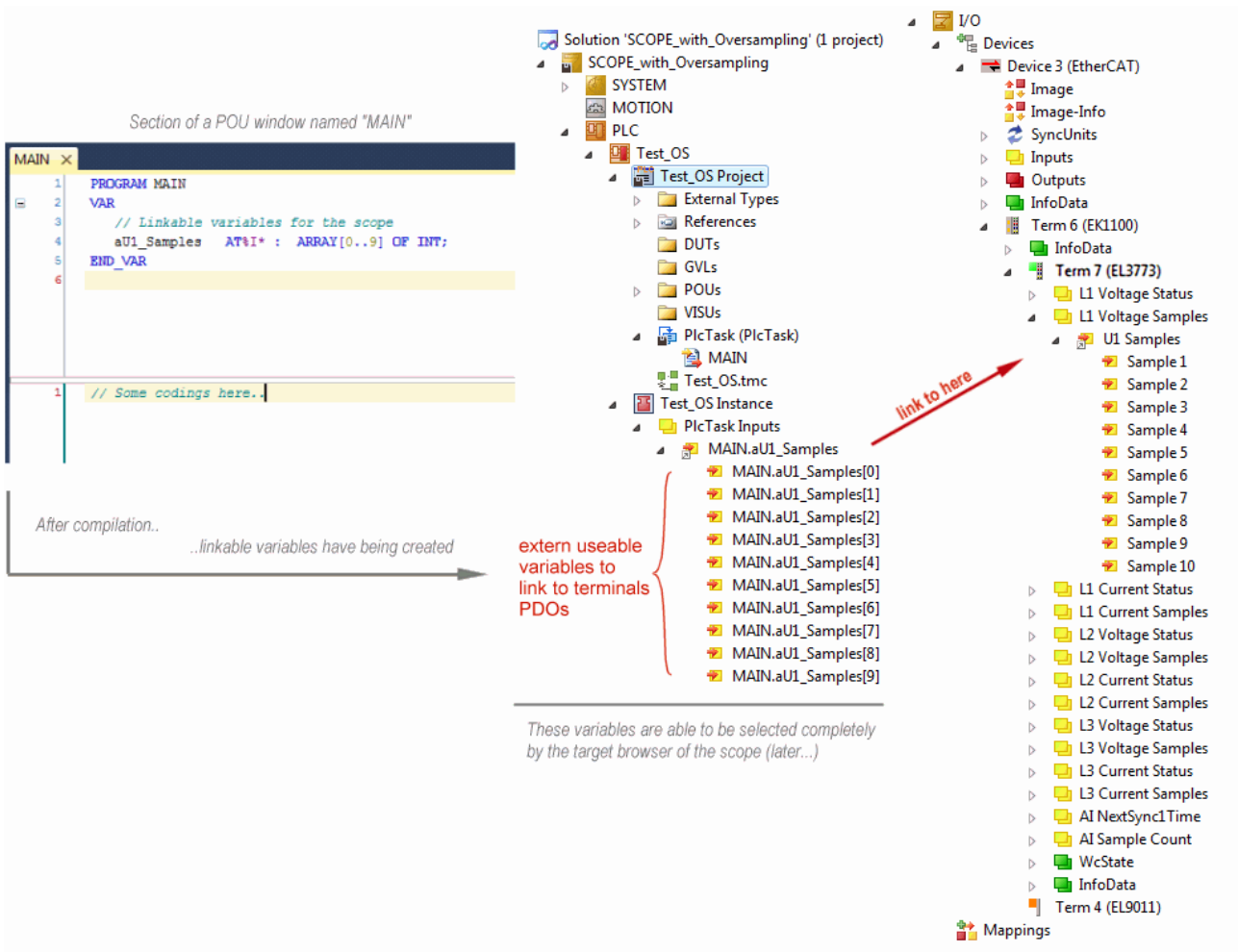

Fig. 13: Representation of a created PLC array variable („aU1_Samples“) to link with oversampling PDOs of EL3773

Step 2b: Creation of a PLC variable via a free task

When a POU is not needed onto the particular system, a referenced variable could be applied via a free task also. If a free task is not existing still yet, it can be created by a right-click to “Task” of the project within SYSTEM with “Add New Item...”.

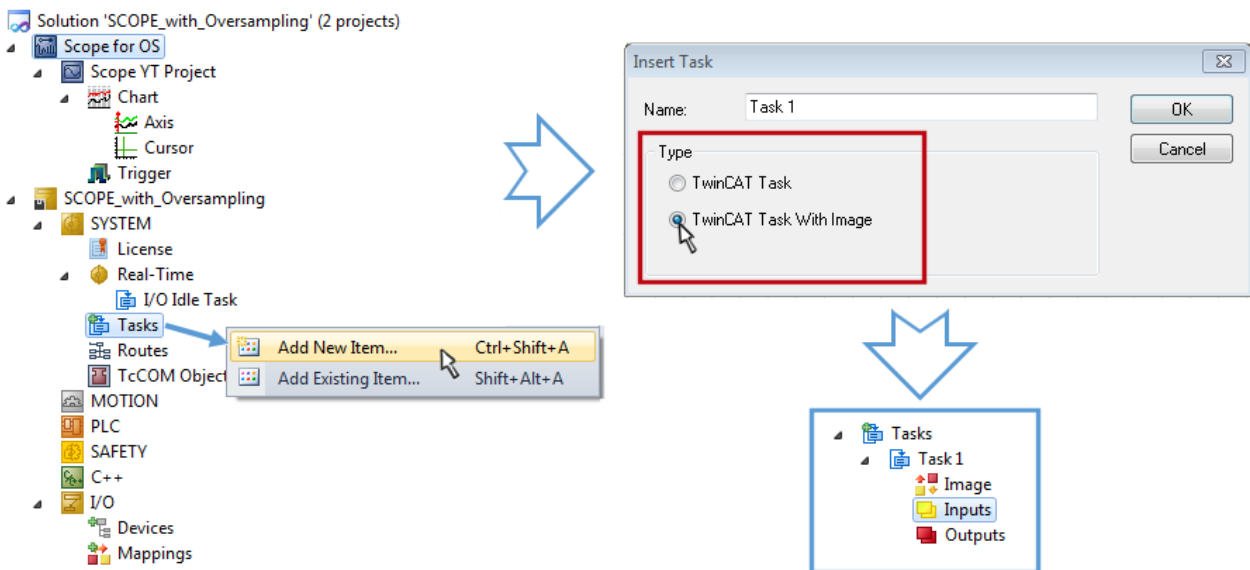

Fig. 14: Insertion of a free task

The Task has to be inserted as “TwinCAT Task With Image” and also creates an “Inputs” and “Outputs” folder therefore. The properties of the new (or as the case may be already existing) task must have activated the attribute “Create symbols” to make them selectable by the “Target Browser” of the Scope later on. The task cycle time has to be changed if so. Then, with 10 x Oversampling 1 ms at 100 µs base time, resulting 10 ticks will be set by the usage of the EL3751 for example:

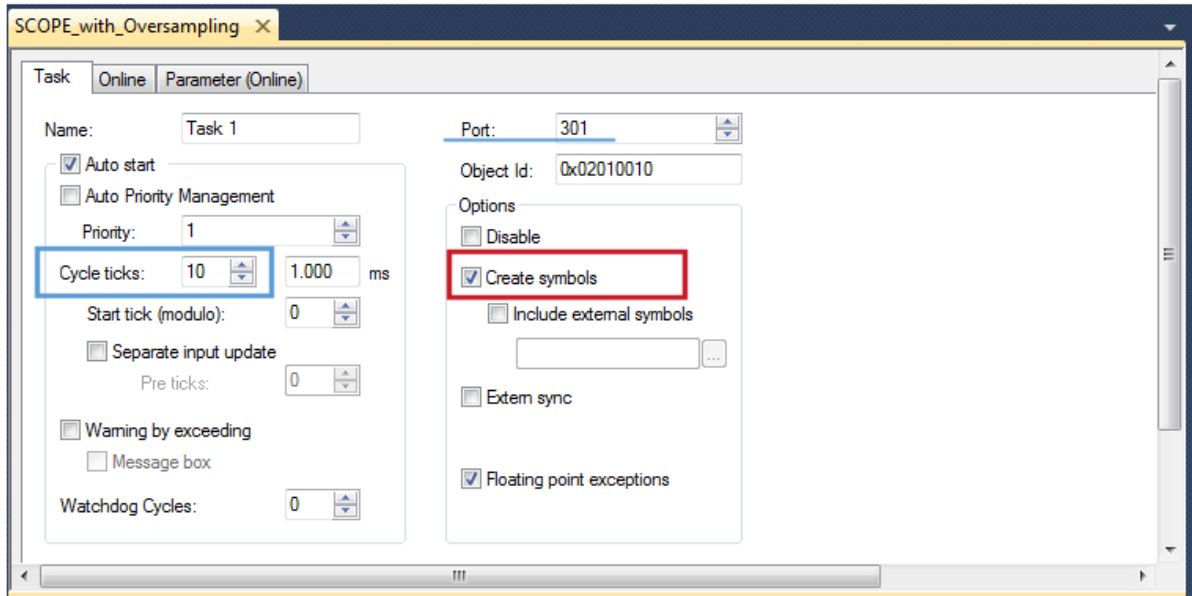

Fig. 15: Task property "Create symbols" must be activated

There's a default value given for the Port number (301) that should be changed, if necessary. This number has to make acquainted for the Scope, if applicable, later on. By a right click on “Inputs” that oversampling based variable can now be appended with the fitting datatype of an array. „ARRAY [0..9] OF DINT“ referred to as „Var 1“ in this case:

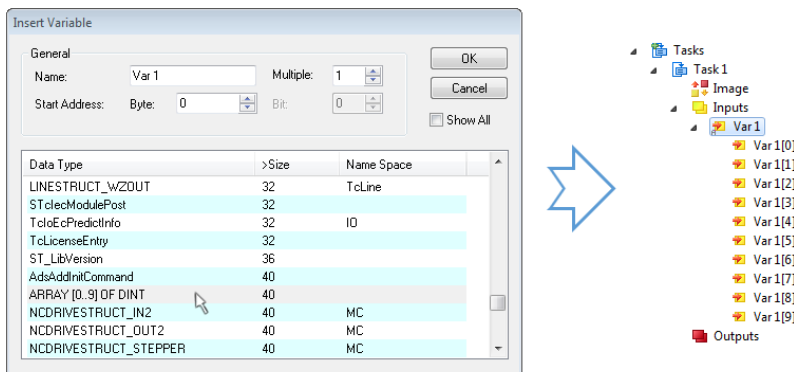

Fig. 16: Insertion of variable "Var 1" fitting to the oversampling (-factor)

Step 3: Linking an array variable with an oversampling PDO

By right click on “MAIN.aUI_Samples” (according to the last preceding paragraph Step 2a) or rather “Var 1” of the free Task 1 (according to the last preceding paragraph Step 2b) within the Solution Explorer a window opens to select the process data:

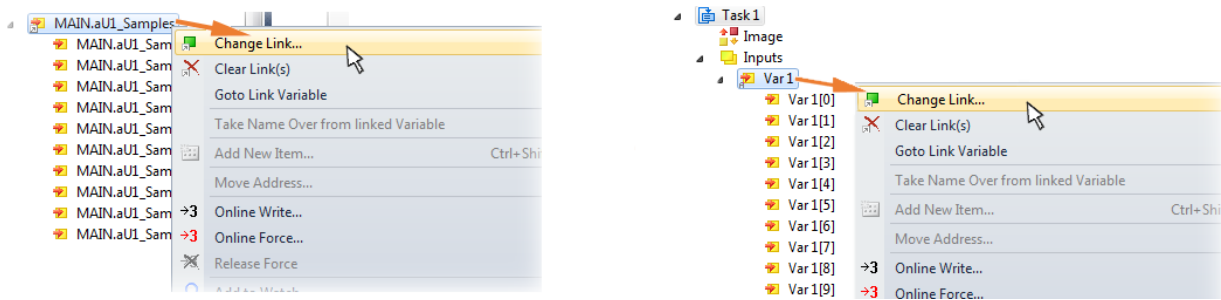

Fig. 17: Set up the link of the PLC array variable (left: for the last preceding paragraph Step 2a, right: for the last preceding paragraph Step 2b)

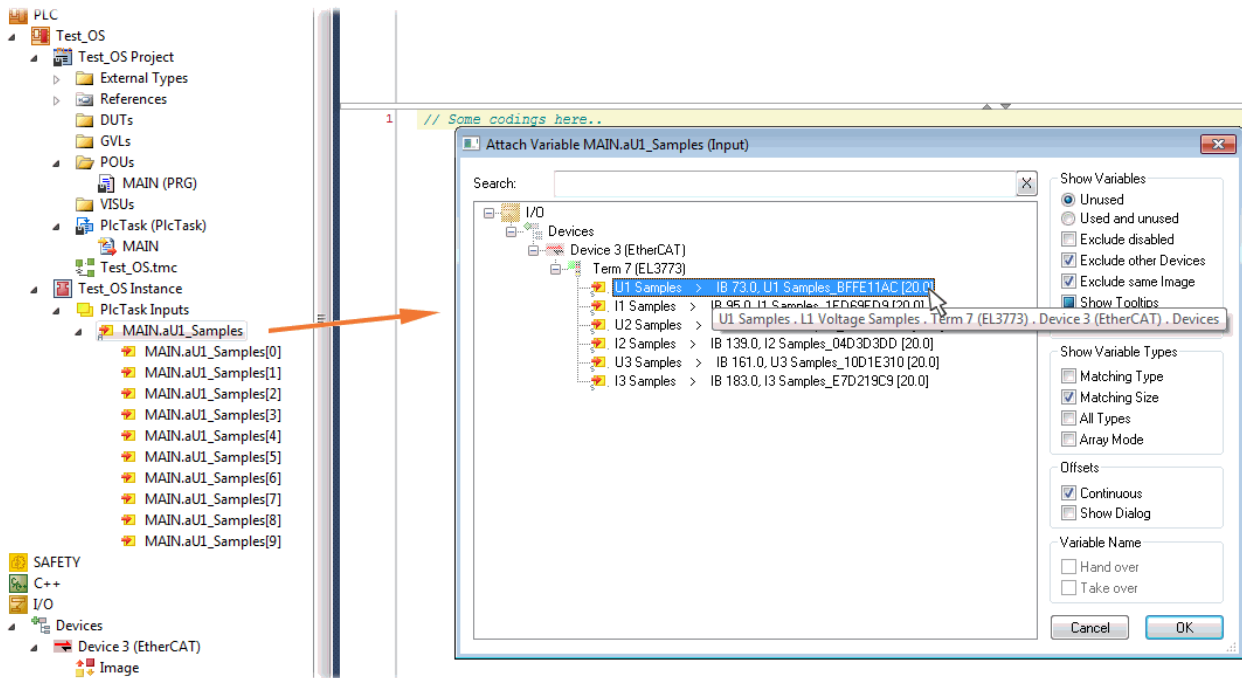



Fig. 18: Select the EL3773 PDO "L1 Voltage Samples" to create a link to the PLC array variable „aUI_Samples“

The selection of PDO "U1 Samples" of the EL3773 for "MAIN.aUI_Samples" based by the last preceding paragraph Step 2a as illustrated above have to be done in the same way for "Var 1" accordingly.

Step 4: Selection of the PLC array variable for the Y-axis of the scope

Now the configuration will be activated () and logged in the PLC (), so the array variable will be visible for the target browser of the scope for being selected.

Thereby the drop down menu will be opened by right clicking on "Axis" (A) for selection of the scope features (B):

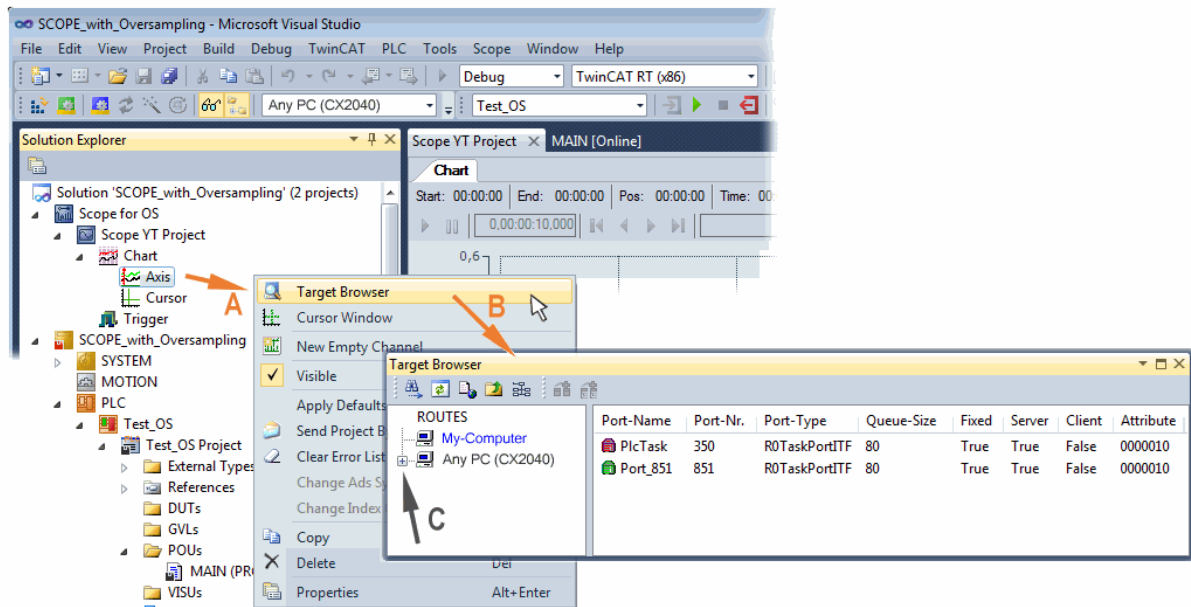

Fig. 19: Selection of the oversampling variable with the target browser

By addressing the corresponding system that represents the PLC containing the array variable (“Any PC (CX2040)”) in this case) navigation up to the variable “aUI_Samples” (C) have to be done.

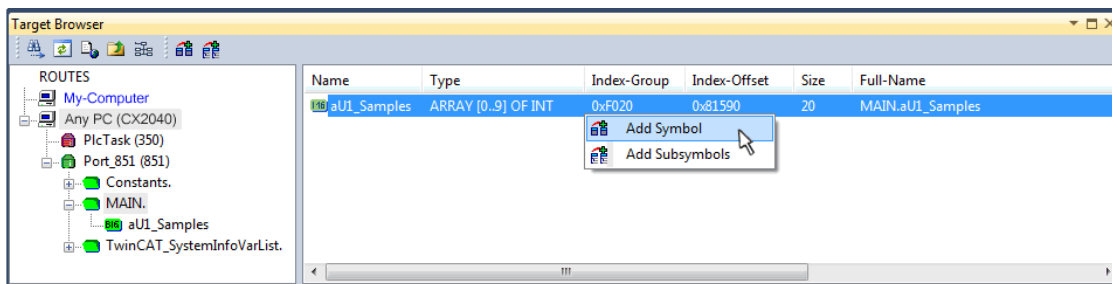

Fig. 20: Appending the variable "aUI_Samples" below "axis" within the scope project of the solution explorer

i Variable don't appears into the target browser

If „ROUTES“ don't offer a possibility for selection of the provided variables, the corresponding port should be declared for the target browser:



"Enable Server Ports"

Using “Add symbol” displays the variable "aUI_Samples" below “axis” within the scope project of the solution explorer directly.

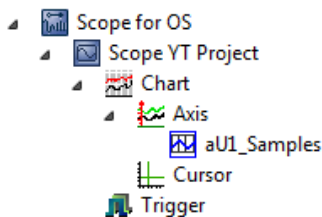

Now the program start has to be done with  formally although there's no program still yet. Using "Start

Recording"  the process data value of the oversampling PDO "L1 Voltage Samples" via the linked PLC array variable can be recorded time dependent now.

As an example a sine wave input measurement value (204.5 Hz) will be illustrated below:

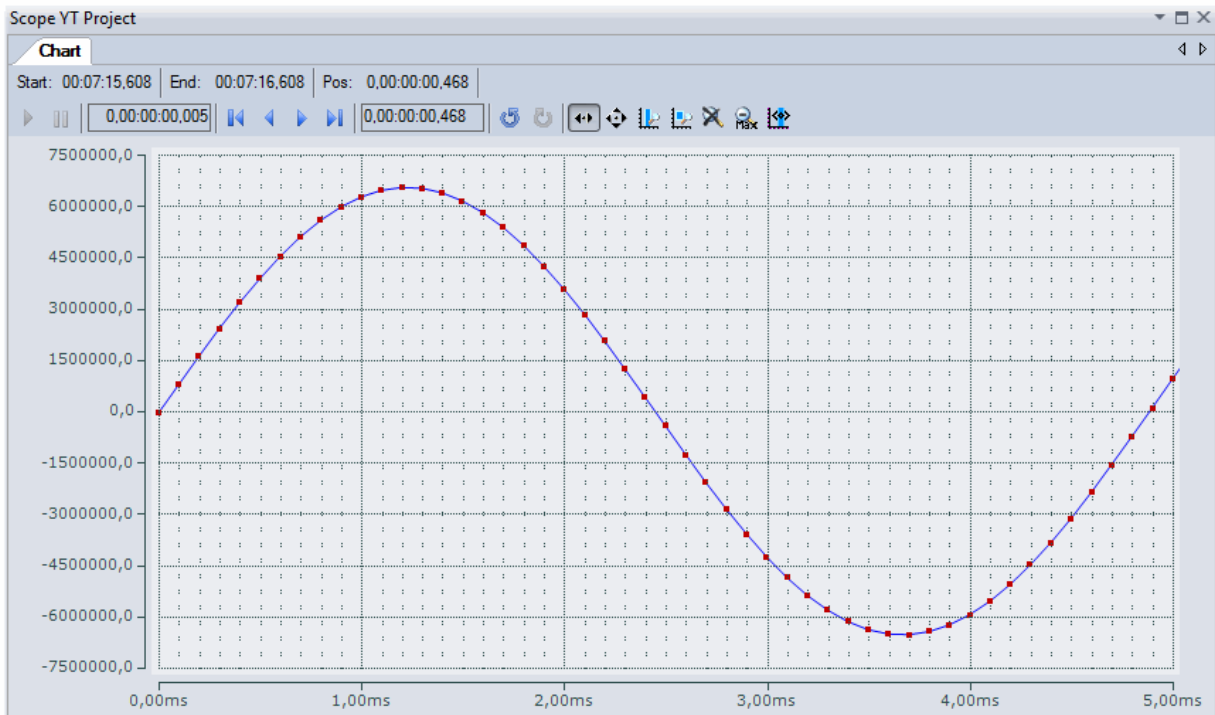



Fig. 21: Example of recording a sine signal with 10 x oversampling at 1 ms measurement cycle time

The X-axis view was fitted properly by using "Panning X"  after the recording was stopped . Following the "Chart" property "Use X-Axis SubGrid" was set to true with 10 divisions as well as the "ChannelNodeProperties" attribute "Marks" was set to "On" with the colors "Line Color" blue and "Mark Color" red. Therefore the latter indicates that 10 oversampling measurement points by the red marks.

Proceeding with / via ADS alternatively

In former TwinCAT 3 versions (or a lower revision as specified in the [table \[32 \]](#) above) the oversampling PDO of the respective oversampling able terminal/box can be made visible for the ScopeView by activation of the ADS server.

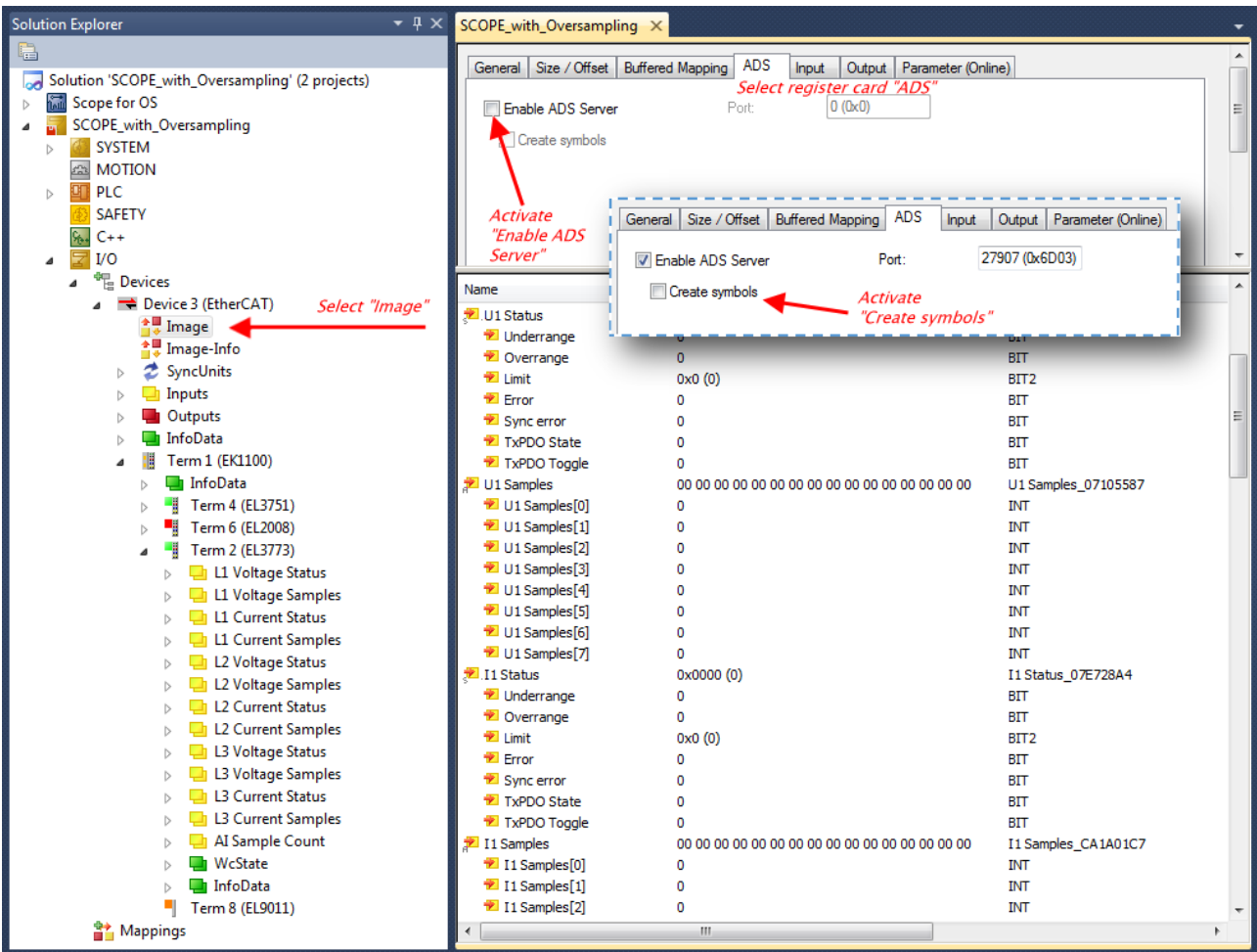

Fig. 22: Activation of the ADS server of the EtherCAT device (TwinCAT 3)

The activation of the server can be carried out by selection of "Image" within the left sided solution explorer: „I/O → Devices → Device .. (EtherCAT) → Image“.

Next the register card "ADS" have to be selected to activate each checkbox „Enable ADS Server“ and „Create symbols“ then (the port entry is done automatically).

Thereby it is possible to access process data without an embedded POU and accordingly without a linked variable:

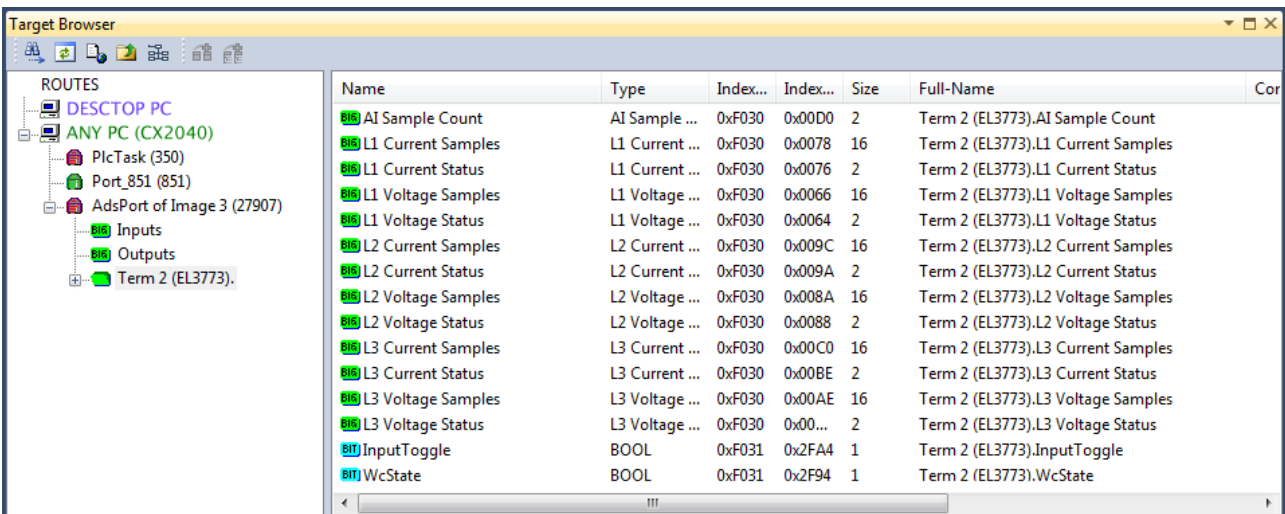
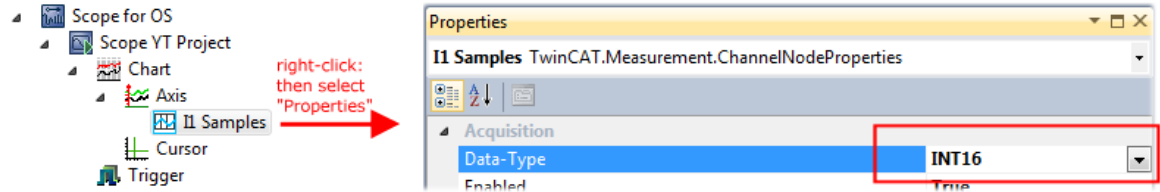

Fig. 23: Direct access to PDOs of the terminal by ScopeView

i Data type not valid

It may happen that the target browser is unable to determine the data type after insertion of the oversampling PDO (according to an array variable usually). In this case it can be changed by the channel properties:



i TwinCAT 3: Activate the ADS Server of an EtherCAT device

Also see Beckhoff Information System:
infosys.beckhoff.com → TwinCAT 3 → TExxxx | TwinCAT 3 Engineering → TE13xx | ScopeView → Appendix → How To → Oversampling recordings with the TwinCAT 3 Scope

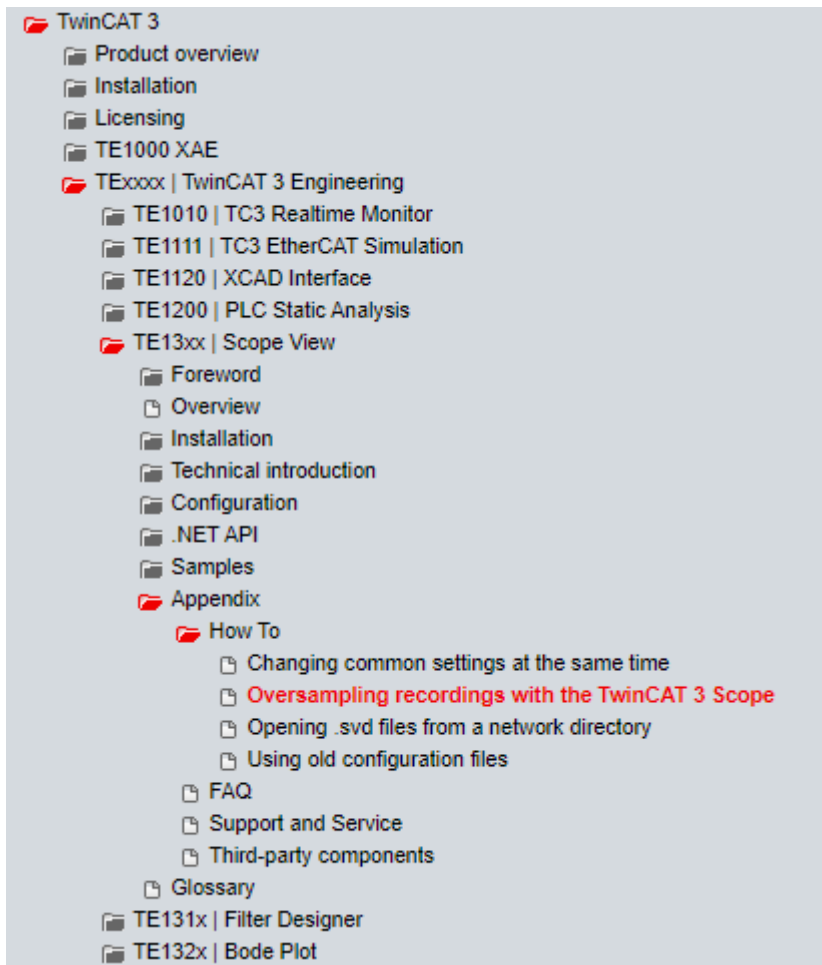

5.2.2 TwinCAT 2 procedure

The TwinCAT Scope2 supports the import and display of oversampling process data such as is used by oversampling-able terminals/box modules.

System requirements

- i** A TwinCAT Scope2 must be installed on the system.
- An oversampling-able terminal must be present in the configuration.

The data type of the variables is also conveyed to the TwinCAT Scope2 via the ADS data. Therefore, the array variable must be created

- in the PLC, see [step 1a \[▶ 41\]](#)
- or directly in the System Manager if only one free task is present, see [step 1b \[▶ 41\]](#)

The same settings are to be made in the Scope2 for both cases, see [step 2 \[▶ 43\]](#)

Recording of a PLC variable with the TwinCAT 2 – Scope2

Step 1a: TwinCAT 2 PLC

Since the channel data are to be used in the PLC, a linkable ARRAY variable must be created there, as shown in the following example:

```
VAR
    aiEL3773_Ch1_DataIn AT%I*: ARRAY[1..10] OF INT;
END_VAR
```

Fig. 24: PLC declaration

This then appears in the list in the System Manager; as a rule it can also be reached via ADS without further measures since PLC variables are always created as ADS symbols in the background.

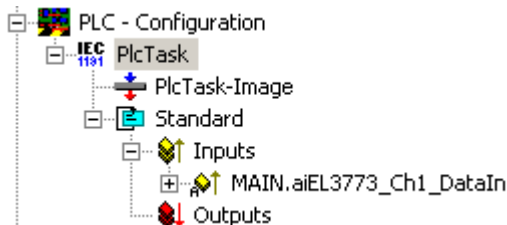

Fig. 25: PLC in the System Manager

Note: The Scope2 can only "see" such variables in the variable browser if TwinCAT and the PLC are in RUN mode.

Step 1b: TwinCAT 2 - free task

The array variable required for Scope2 can alternatively be defined and created manually in the System Manager.

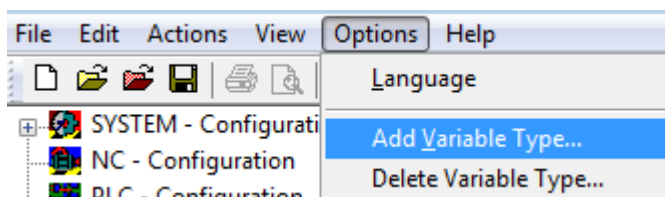

Fig. 26: Add Variable Type

As before in the program (POU "Main"), an ARRAY variable of the same type as from the oversampling PDO of the respective terminal/box must be created. In this example an array of 0..9 of the type INT, i.e. with 10 fields.

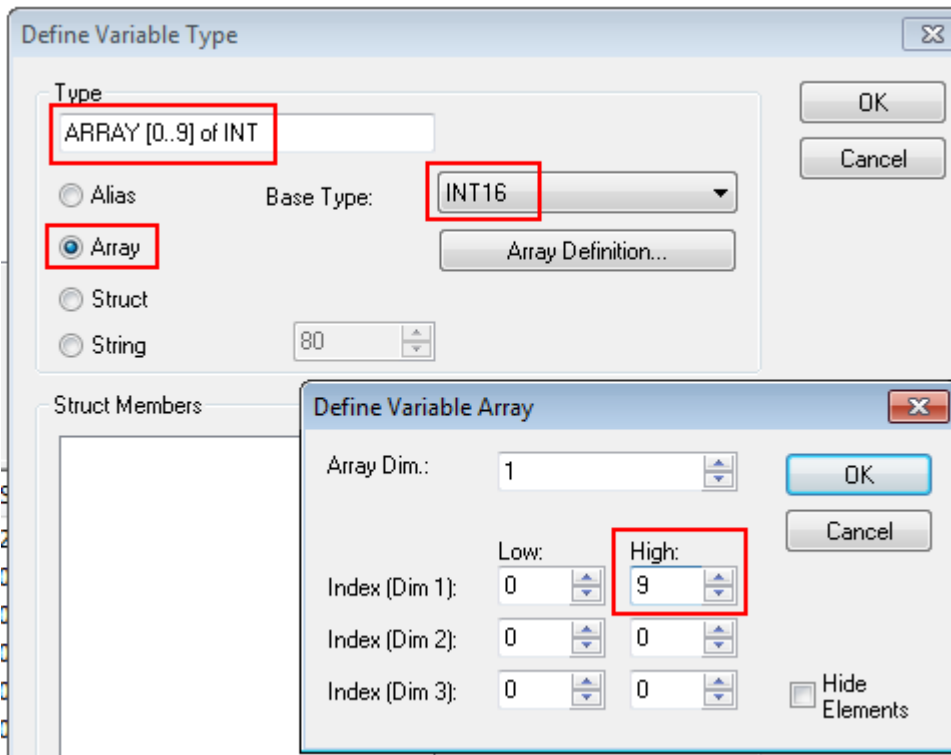

Fig. 27: Definition of the variable type

If this variable is known to the System Manager, an instance of it can be assigned to an additional task with a right-click. It appears in the overview, sorted according to bit size.

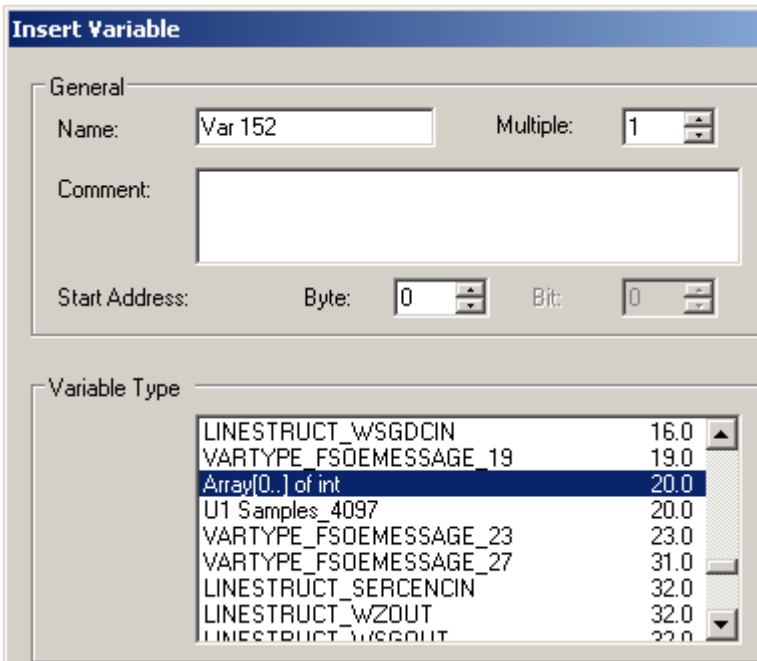

Fig. 28: Overview of declared types

In this example the variable *Var152* is created. It can now be linked with the PDO-Array of the respective channel of the terminal/box.

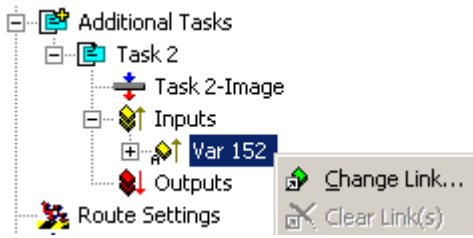

Fig. 29: Linking

If *MatchingSize* is activated in the dialog, the individual channels are offered directly.

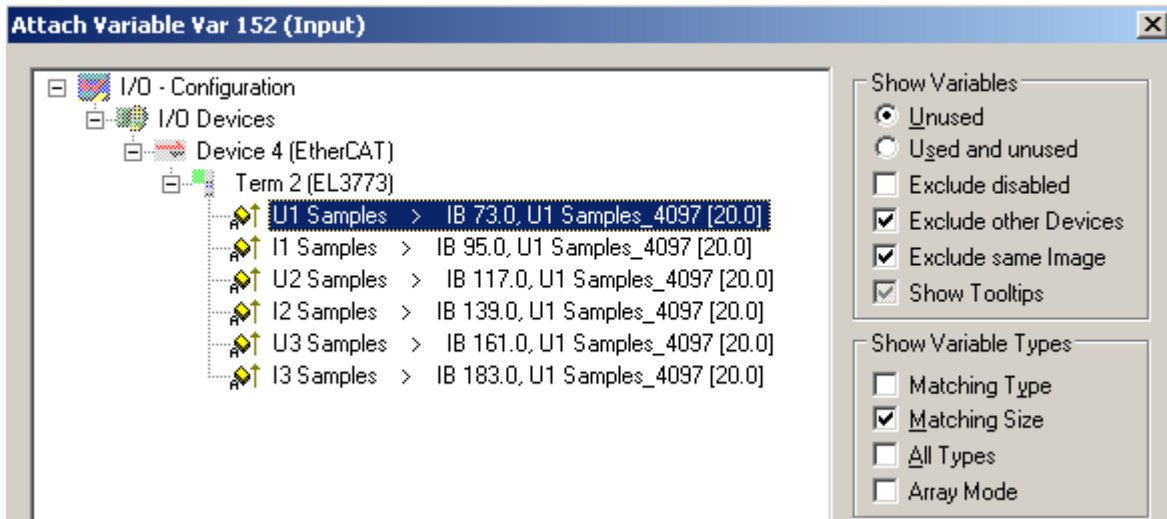

Fig. 30: Array variables of an oversampling terminal

So that the variables can also be found via ADS in the Scope2, the ADS symbols must be activated as well as the Enable Auto-Start, otherwise the task will not run automatically. ADS symbol tables are then created for all variables that have this task in their process data images.

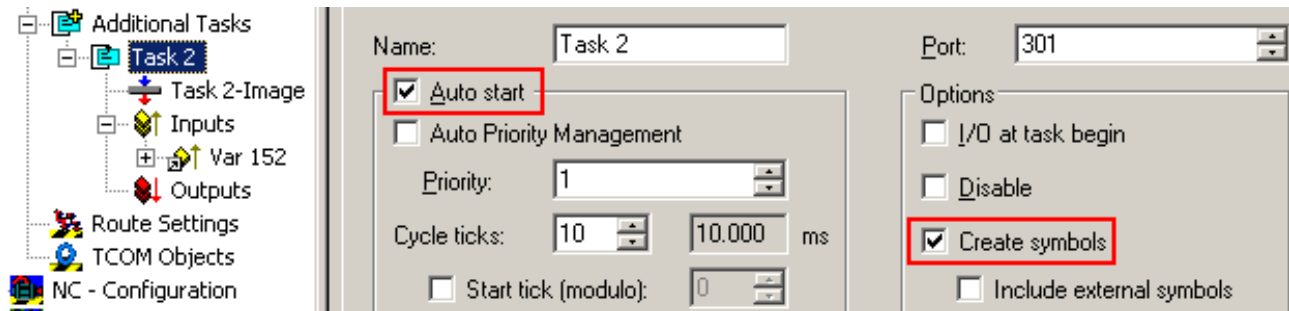

Fig. 31: Settings in the additional task

Step 2: Configuration in the Scope2

So that the linking works, an array variable with the channel data of the respective terminal/box must be present in the system manager; i.e. each oversampling data package must be present in an array. This array variable must be defined and created manually; [see above \[▶ 41\]](#).

You can now browse to the variable concerned in the Scope2.

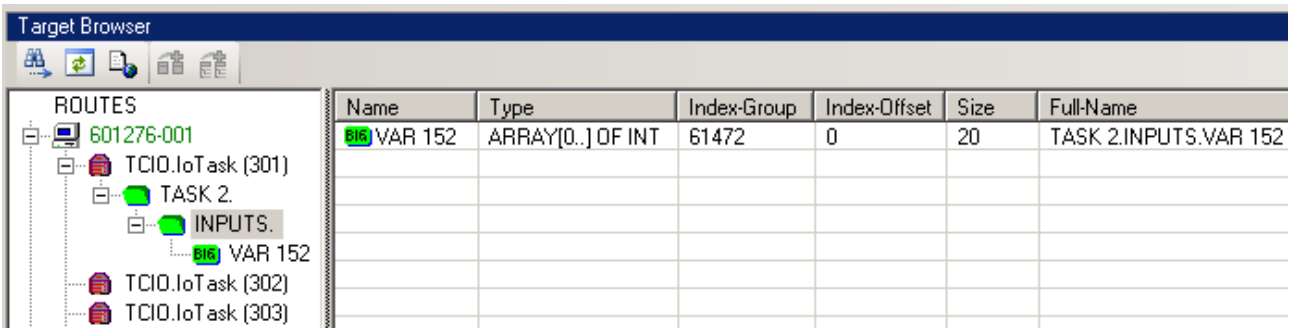

Fig. 32: Variable browser up to the array VAR152

The array is then not to be opened; instead the array symbol is to be selected by right-clicking on *AddSymbol*.

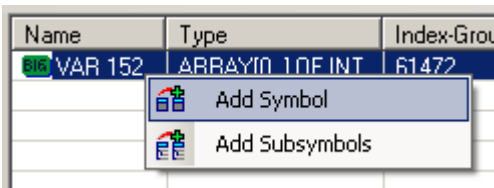

Fig. 33: AddSymbol on the array

ForceOversampling and *Data Type* INT16 must be set in the channel which has now been created. If necessary *SymbolBased* must be temporarily deactivated in addition.

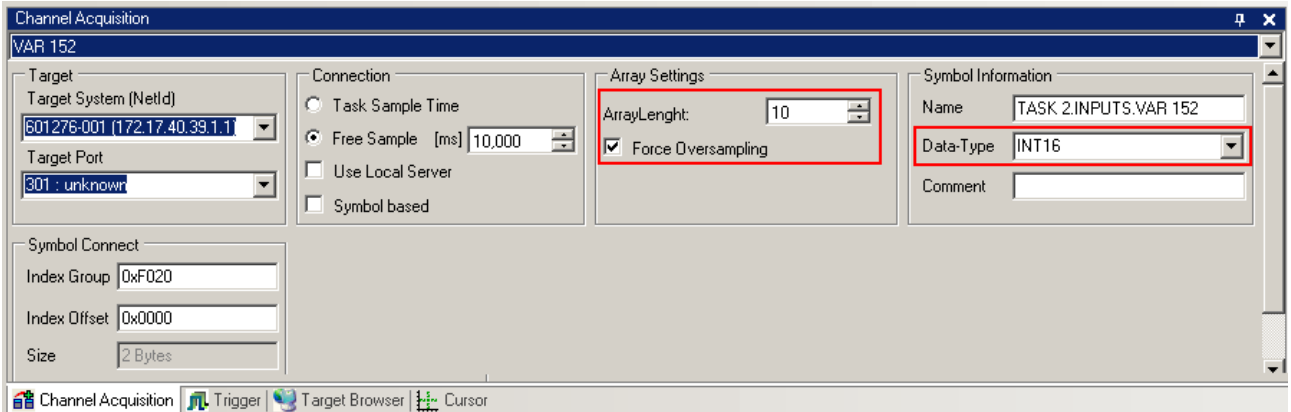

Fig. 34: Channel settings

In order to check that individual oversampling values are really being logged, the *Marks* can be activated in the Scope2. Please observe the interrelationships between task cycle time, sampling time of the Scope2 channel and oversampling factor.

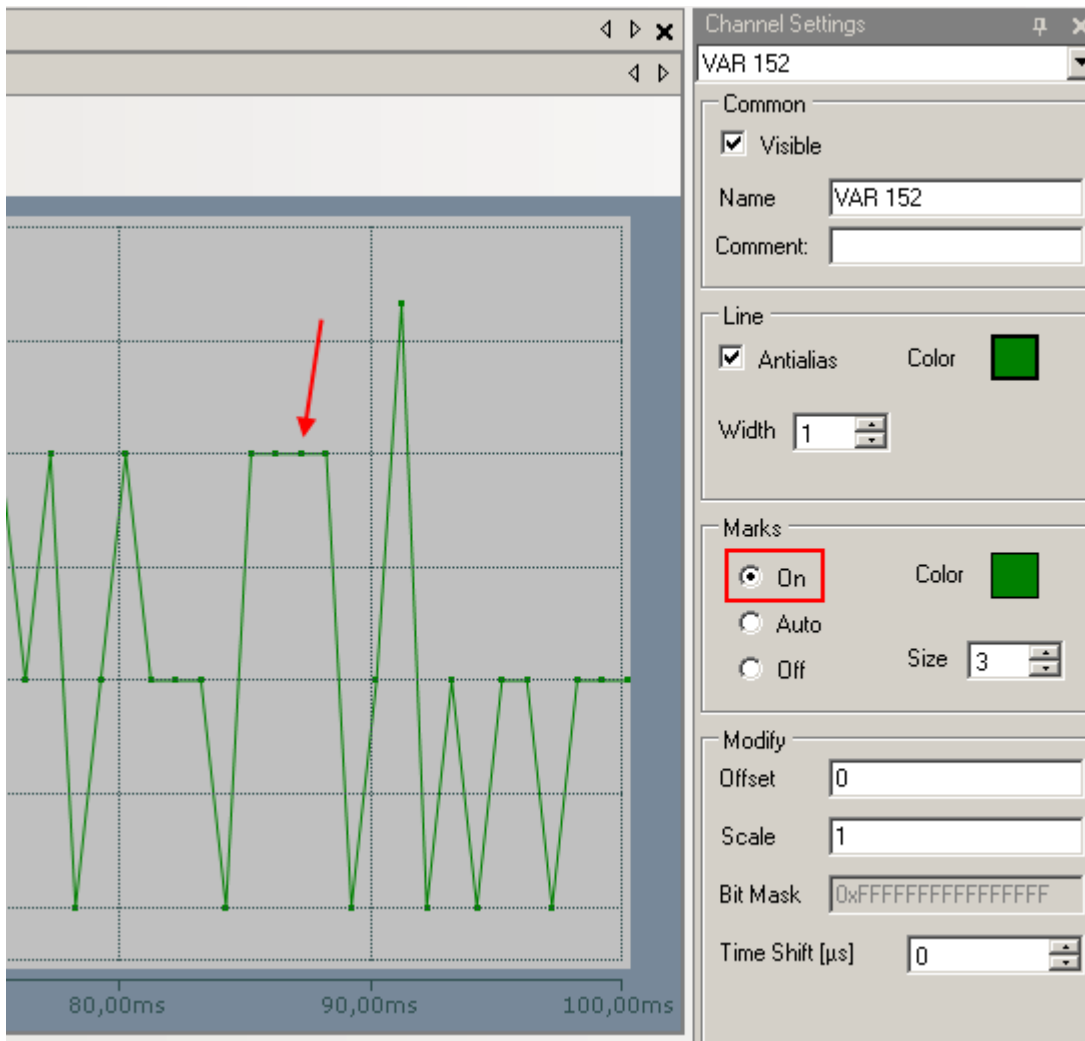

Fig. 35: Activation of the marks

An additional example illustrates the following image by representation of an oversampling – variable from the EL3751 with 10 x oversampling:

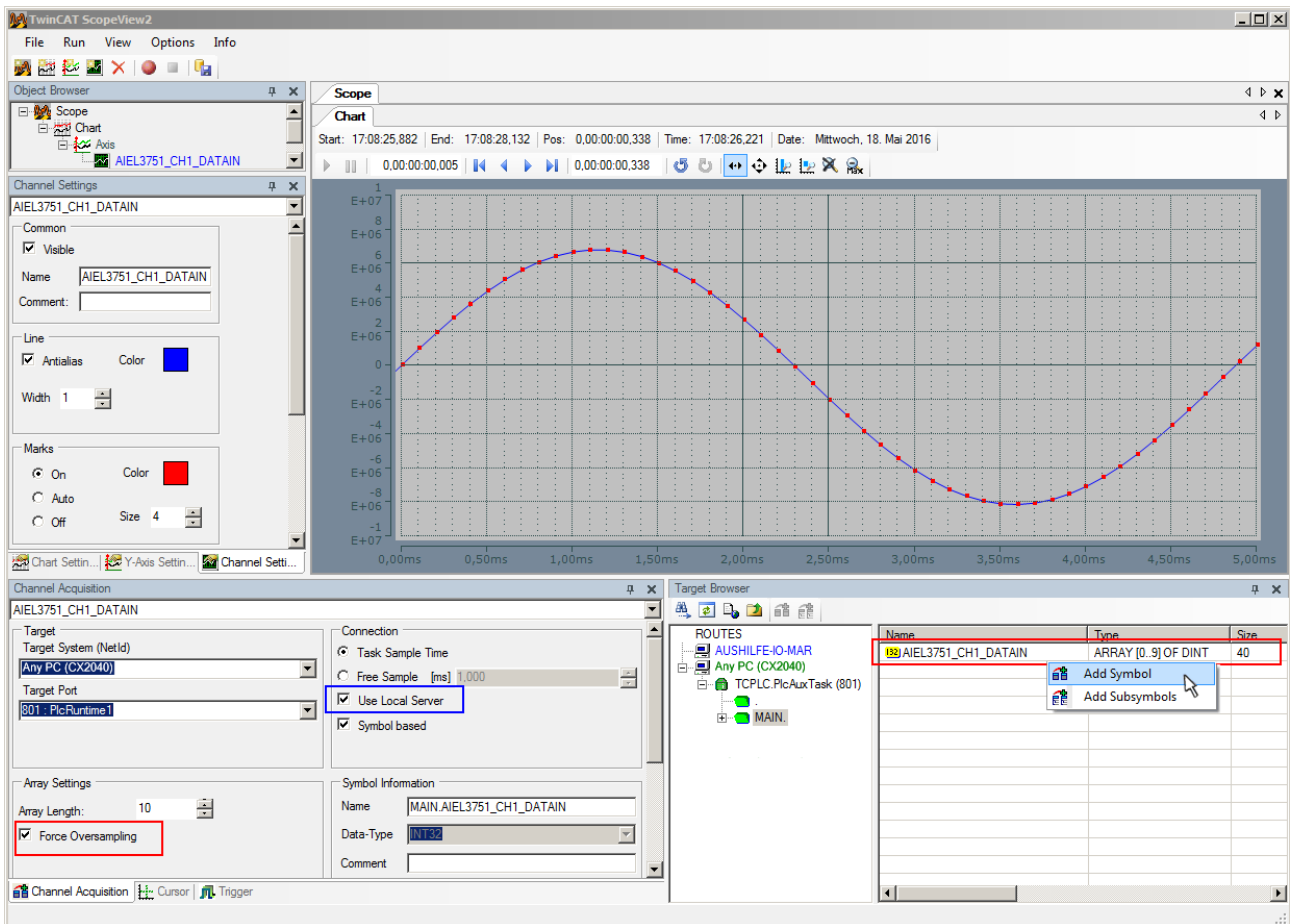

Fig. 36: Illustration of a 10 x oversampling variable of the EL3751 by the Scope2

Within the image was marked subsequently that the oversampling variable originated by the PLC was just added to the Y-axis (observe selection of the PLC-POU name “MAIN” within the “ROUTES” tree). Herewith “Force Oversampling” was activated due to the oversampling variable is not provided by the terminal/box.

Proceeding with TwinCAT 2/ alternatively via ADS

In former TwinCAT 2 versions (or a lower revision as specified in the [table \[▶ 32\]](#) above) the oversampling PDO of the respective oversampling able terminal/box can be made visible for the Scope2 by activation of the ADS server.

So, the creation of a PLC variable can be disclaimed as well. Therefore, the ADS server of the EtherCAT Device where the oversampling able terminal/box is connected with have to be activated.

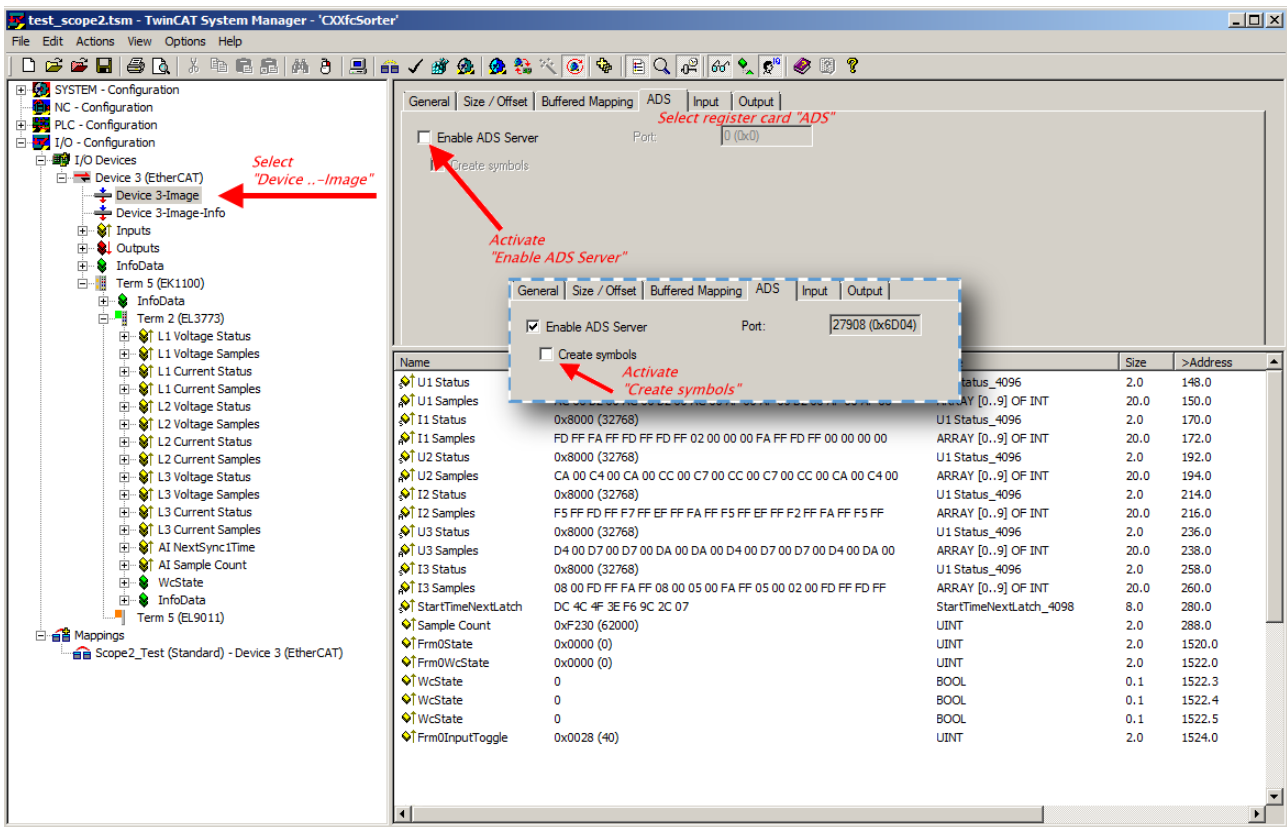

Fig. 37: Activation of the ADS server of the EtherCAT Device (TwinCAT 2)

The activation of the ADS server have to be carried out by selection of the “Device – Image” on the left sided configuration tree:

„I/O – Configuration → I/O Devices → Device .. (EtherCAT) → Device .. – Image“.

Next the register card “ADS” have to be selected to activate each checkbox „Enable ADS Server“ and „Create symbols“ then (the port entry is done automatically).

Thus, with the Scope2 process data can be accessed via the target browser without an embedded POU and without a variable reference respectively.

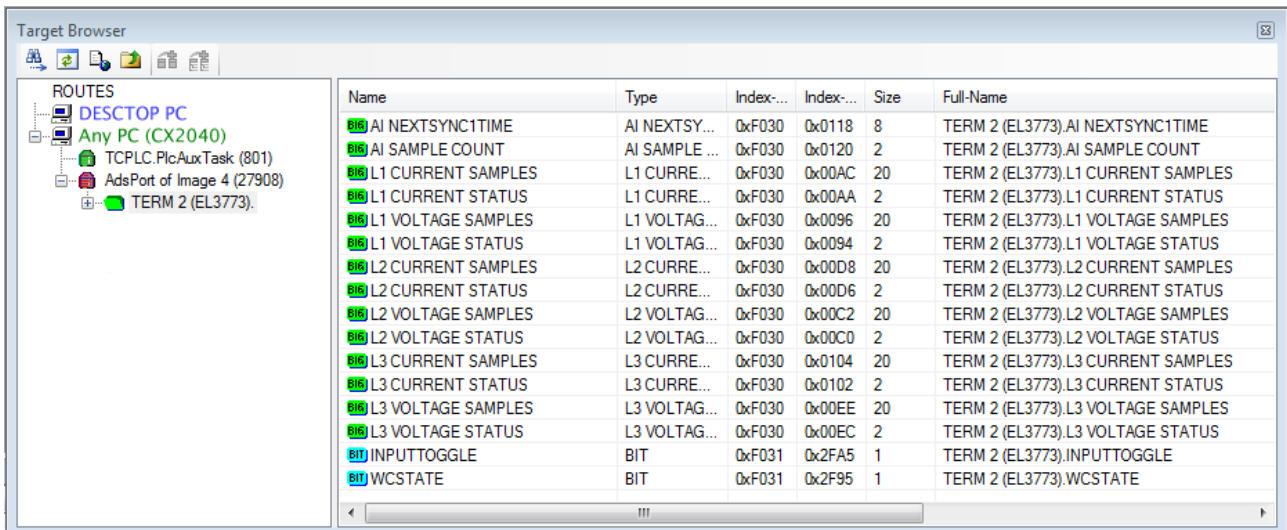
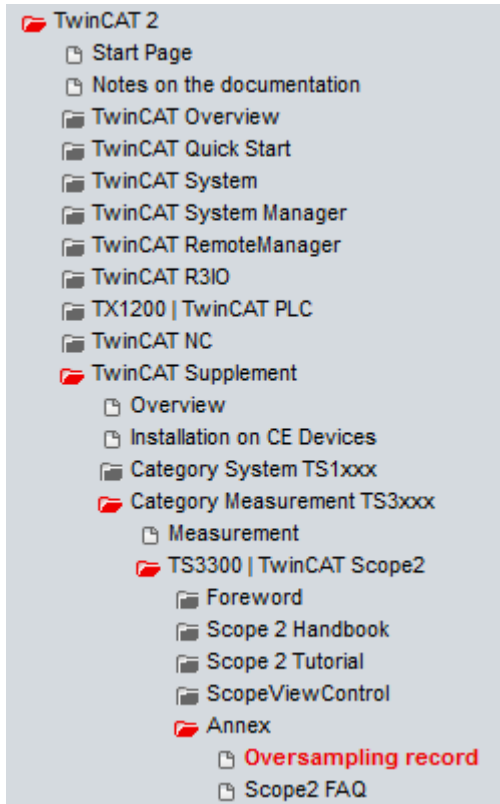

Fig. 38: Direct access of the Scope2 to the terminal's PDOs

Also see Beckhoff Information System

infosys.beckhoff.com → TwinCAT 2 → TwinCAT Supplement → Category Measurement TS3xxx → TS3300 | TwinCAT Scope 2 → Annex → Oversampling record:



Beckhoff TwinCAT supports the Scope2 with some oversampling devices in a special way by automatically calculating a special ADS array symbol in the background, which appears in the Scope2 in the variable browser. This can be then linked as a variable and automatically brings along the array information.

Name	Type	Index...	Index...	Size	Full-Name
CH1 SAMPLE 0[0]	CH1 SAMPLE_0_TYPE	61488	73	2	TERM 2 (EL3702).CH1 SAMPLE 0[0]
CH1 SAMPLE 0[1]	CH1 SAMPLE_0_TYPE	61488	75	2	TERM 2 (EL3702).CH1 SAMPLE 0[1]
CH1 SAMPLE 0[2]	CH1 SAMPLE_0_TYPE	61488	77	2	TERM 2 (EL3702).CH1 SAMPLE 0[2]
CH1 SAMPLE 0[3]	CH1 SAMPLE_0_TYPE	61488	79	2	TERM 2 (EL3702).CH1 SAMPLE 0[3]
CH1 SAMPLE 0[4]	CH1 SAMPLE_0_TYPE	61488	81	2	TERM 2 (EL3702).CH1 SAMPLE 0[4]
CH1 SAMPLE 0[5]	CH1 SAMPLE_0_TYPE	61488	83	2	TERM 2 (EL3702).CH1 SAMPLE 0[5]
CH1 SAMPLE 0[6]	CH1 SAMPLE_0_TYPE	61488	85	2	TERM 2 (EL3702).CH1 SAMPLE 0[6]
CH1 SAMPLE 0[7]	CH1 SAMPLE_0_TYPE	61488	87	2	TERM 2 (EL3702).CH1 SAMPLE 0[7]
CH1 SAMPLE 0[8]	CH1 SAMPLE_0_TYPE	61488	89	2	TERM 2 (EL3702).CH1 SAMPLE 0[8]
CH1 SAMPLE 0[9]	CH1 SAMPLE_0_TYPE	61488	91	2	TERM 2 (EL3702).CH1 SAMPLE 0[9]
CH1 SAMPLE 0[T10]	CH1 SAMPLE_0_TYPE	61488	73	2	TERM 2 (EL3702).CH1 SAMPLE 0[T10]

Name	Type	Index...	Index...	Size	Full-Name
CH1 VALUE	INT16	61488	73	2	TERM 2 (EL3702).CH1 SAMPLE 0[T10].CH1 VALUE

Fig. 39: Automatically calculated array variable (red) in the Scope2

Summary: an array variable has to be provided which is reachable via ADS. This can be a PLC variable of a POU or a defined array variable by the system manager or alternatively the ADS server of the device of the terminal or box is just activated. This is then detected by Scope2.

5.3 Commissioning

The data flow through of the terminal's channel is recorded below. The elements involved are described in detail in this chapter.

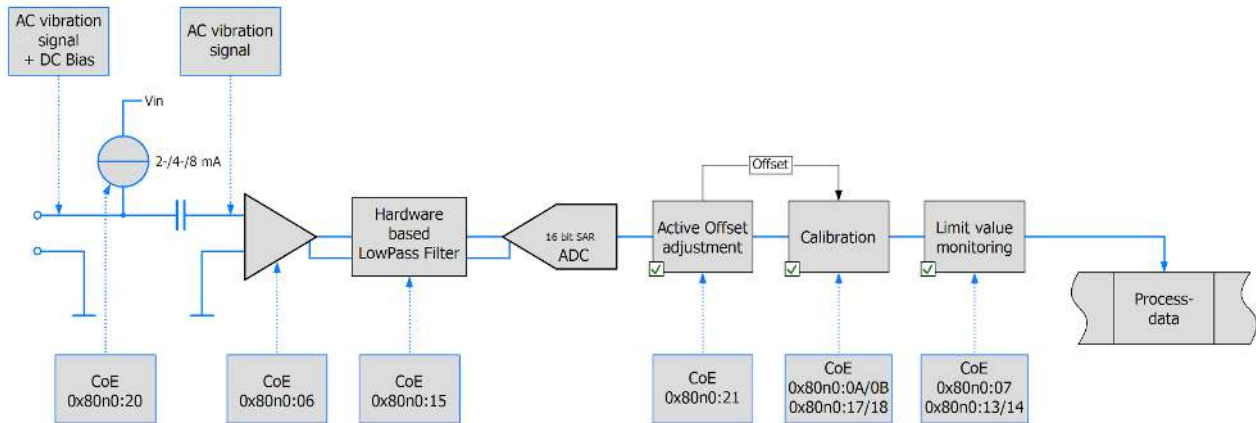

Fig. 40: Data flow of a channel

Note: The sampling rate in the ADC and the low-pass filter can be set independently of each other. For example, the filter can be set to half the sampling rate or to the next possible setting if required for the application.

Determination of the desired sampling rate

The necessary/desired sampling rate results from the selected cycle time and the set oversampling factor. Automatic setting of the terminal/box by the selection of the sampling rate alone is not possible.

Maximum values: 50-fold oversampling, 50 kSP/s, cycle time 10 ms

Sampling Rate	Cycle time / μ s						
	100	200	250	500	1000	2000	
Oversampling factor	1	10 kSps	5 kSps	4 kSps	2 kSps	1 kSps	0,5 kSps
	2	20 kSps	10 kSps	8 kSps	4 kSps	2 kSps	1 kSps
	4	40 kSps	20 kSps	16 kSps	8 kSps	4 kSps	2 kSps
	5	50 kSps	25 kSps	20 kSps	10 kSps	5 kSps	2,5 kSps
	8		40 kSps		16 kSps	8 kSps	4 kSps
	10		50 kSps	40 kSps	20 kSps	10 kSps	5 kSps
	16					16 kSps	8 kSps
	20				40 kSps	20 kSps	10 kSps
	25				50 kSps	25 kSps	12,5 kSps
	32						16 kSps
	40					40 kSps	20 kSps
	50					50 kSps	25 kSps

Fig. 41: Sampling rates in relation to cycle time and oversampling

Sampling Time	Cycle time / μs						
	100	200	250	500	1000	2000	
Oversampling factor	1	100 μs	200 μs	250 μs	500 μs	1000 μs	2000 μs
	2	50 μs	100 μs	125 μs	250 μs	500 μs	1000 μs
	4	25 μs	50 μs	62,5 μs	125 μs	250 μs	500 μs
	5	20 μs	40 μs	50 μs	100 μs	200 μs	400 μs
	8		25 μs		62,5 μs	125 μs	250 μs
	10		20 μs	25 μs	50 μs	100 μs	200 μs
	16					62,5 μs	125 μs
	20				25 μs	50 μs	100 μs
	25				20 μs	40 μs	80 μs
	32						62,5 μs
	40					25 μs	50 μs
	50					20 μs	40 μs

Fig. 42: Sampling times in relation to cycle times and oversampling

Configurations that demand sampling times not divisible by 500 ns are not supported.

Setting the sampling rate

1. Select the terminal/box in the TwinCAT tree
2. Select the "DC/Oversampling" tab
3. Select the operating mode (1/2-channel)
4. "Sync Unit Cycle Time" is indicated; on the basis of the above table...
5. Select the oversampling factor. The "Sample Cycle Time (μs)" indicates the reciprocal value of the sampling rate. The SM automatically activates all process data entries thereafter.

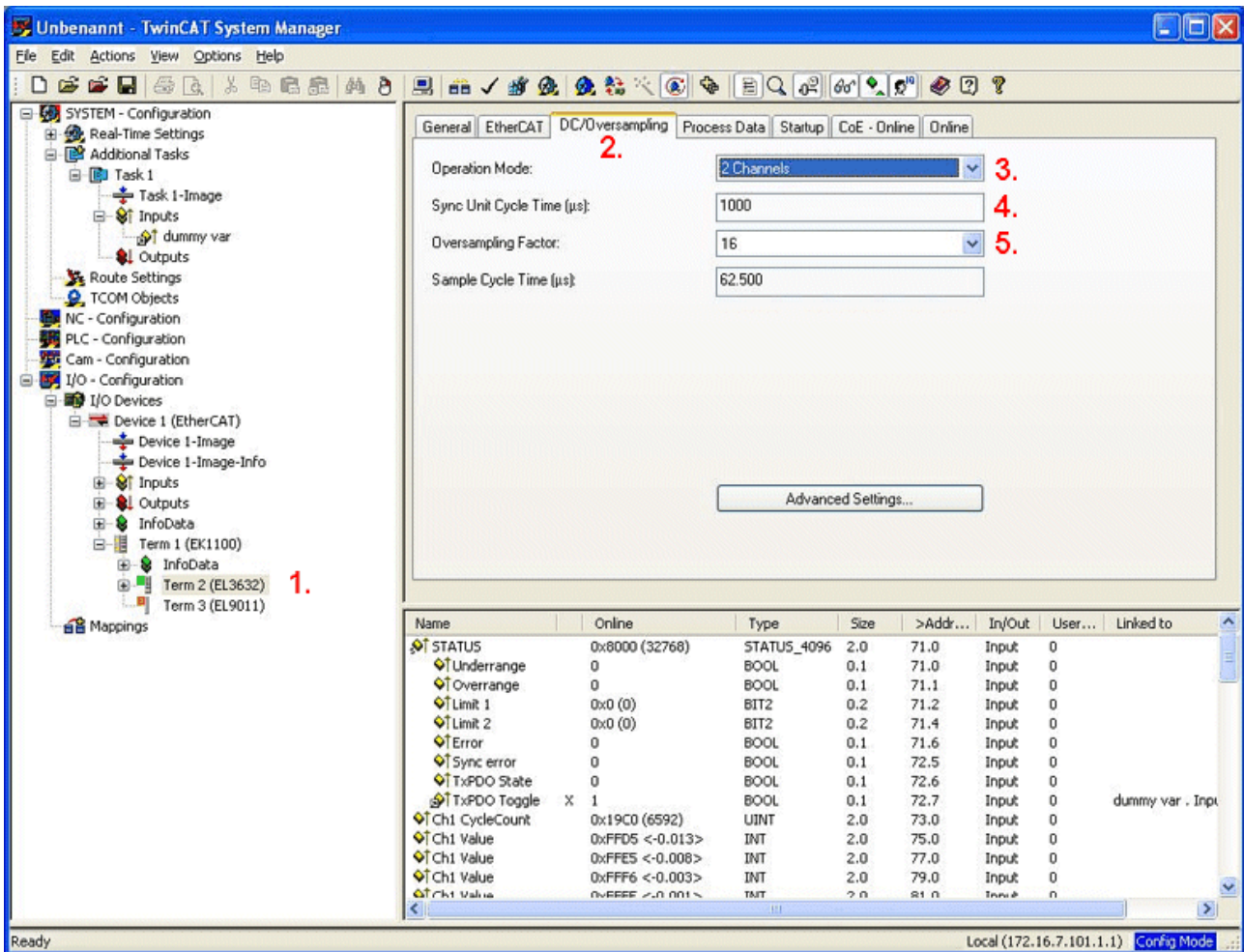

Fig. 43: Setting the sampling rate in TwinCAT

● Loading the configuration data (ESI) from the terminal

i If the online description is used, the DC/Oversampling dialog is not displayed in the TwinCAT System Manager.

To use the dialog, copy the XML Description into the designated TwinCAT/IO/EtherCAT folder before the TwinCAT System Manager is started.

Application with external masters

The oversampling function can also be activated manually: The oversampling factor should be specified depending on the required sampling rate and cycle time.

For each required channel the status word and the corresponding number of samples have to be entered in object 0x1C13. Activate PDOs "Next Sync1 Time" and/or "Sample Counter", if necessary. To this end, initially set subindex 0 to 0 and at the end to the number of entered values.

The sync interrupts should be parameterized as follows: Sync0: CycleTime/Oversampling Factor, set Enable; Sync1 Cycle Unit Cycle, set Enable.

The master must support Distributed Clocks.

Selection of the process data

No longer necessary with TwinCAT.

Filter

Each channel has a parameterizable 5th order filter with Butterworth characteristic with upstream and downstream anti-aliasing filters that are parameterized automatically. The whole filter stage is based on hardware. There are no software filters (except for the active offset setting described below). When the limit frequency is set to 10 Hz (0), an additional amplification factor 20 is activated automatically.

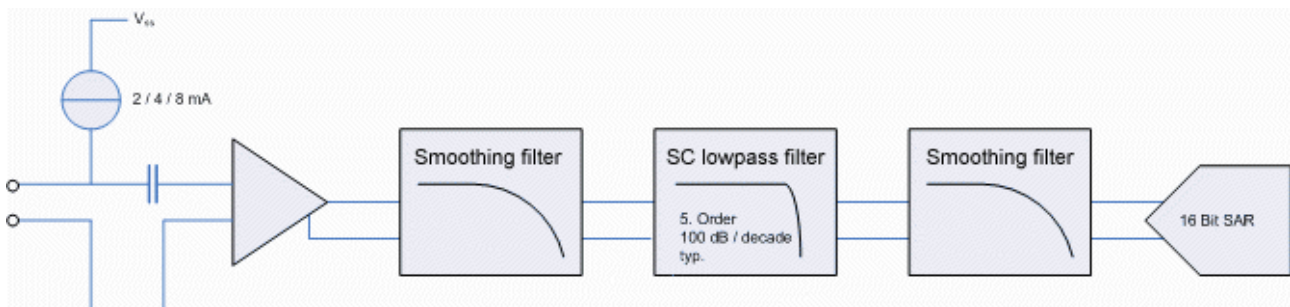

Fig. 44: Filter structure

The analog input filters can be set via the CoE objects 0x80n0:15 (channel 1/2). It is not possible to switch off the filters.

The characteristic of the filter stage is adjustable:

- 0: 10 Hz, Gain 20
- 1: 100 Hz
- 2: 500 Hz
- 3: 1000 Hz
- 4: 5000 Hz
- 5: 10000 Hz
- 6: 25000 Hz
- 7: 2000 Hz (from firmware 11)

● Setting the filters

i The filters must be configured separately for both channels. Setting the filters will interrupt the conversion of new data for a short time.

Active offset setting

The function "Active offset adjustment" calculates the long-term average of the values. The calculated offset value is used instead of the set "user" and "vendor calibration offset" entries. At least one function, "user" or "vendor calibration", must be activated

The calculation of the average value is configurable:

- Level 1: b = 1/4096
- Level 2: b = 1/8192
- Level 3: b = 1/16384
- Level 4: b = 1/32768
- Level 5: b = 1/65536
- Level 6: b = 1/131072 (128 k)
- Level 7: b = 1/262144 (256 k)
- Level 8: b = 1/524288 (512 k).

Calibration

The input values can be calibrated by means of manufacturer or user values:

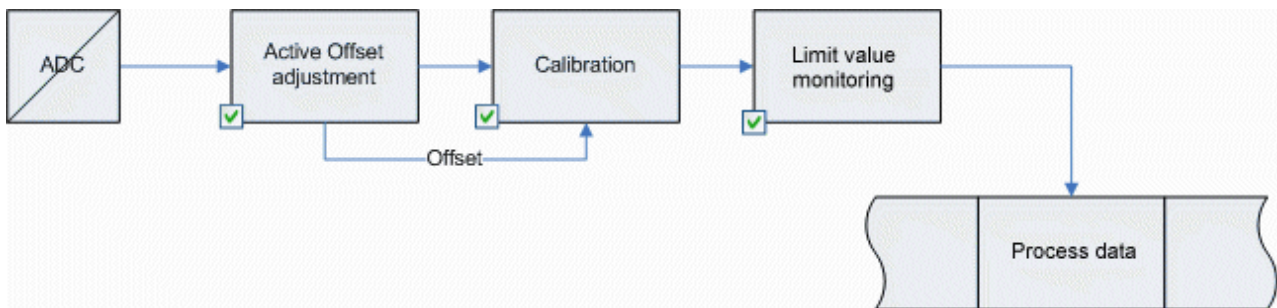

Fig. 5: Data flow

Vendor calibration, index 0x80n0:0B

The vendor calibration is enabled via index 0x80n0:0B. Parameterization takes place via the indices

- 0x80nF:01 offset (manufacturer compensation)
- 0x80nF:02 gain (manufacturer compensation)

$$Y_H = (X_{ADC} - B_K) * A_K$$

Measured value following manufacturer calibration (corresponds to X_{ADC} if index 0x80n0:0B is inactive)

User calibration, index 0x80n0:0A

The user calibration is enabled via index 0x80n0:0A. Parameterization takes place via the indices

- 0x80n0:17 User calibration offset
- 0x80n0:18 User gain compensation

$$Y_A = (Y_H - B_W) * A_W$$

Measured value following user calibration (corresponds to Y_H if index 0x80n0:0A is inactive)

Active offset adjustment

If the function "Active offset adjustment" is active the offset values are not used. Instead, a dynamically calculated offset is subtracted.

Example interpretation

Sample: A sensor with a sensitivity S of 100 mV / g (10.2 mV/(m/s²)) is connected to a synchronized EL3632/EP3632 (15-bit resolution + sign, +/- 5 V). In the process data an amplitude of 1507 is measured.

$$a = Y_A * 5 \text{ V} / (2^{15} * \text{S})$$

$$a = 1507 * 5 \text{ V} / (2^{15} * 0.1 \text{ V/g})$$

$$a = 2.3 \text{ g}$$

$$a = 2.3 \text{ g} * 9.81 \text{ (m/s}^2) / \text{g}$$

$$a = 22.5 \text{ m/s}^2$$

Conversion of process data value Y_A to acceleration a .

$$Y_A = 2^{15} / 5 \text{ V} * \text{S} * a$$

$$Y_A = 2^{15} / 5 \text{ V} * 0.1 \text{ V/g} * 2.3 \text{ g}$$

$$Y_A = 1507$$

Conversion of acceleration g to process data value Y_A .

Sensor connection

The supply current for the sensors is configurable. With 8 mA the vertical (standard) installation position of the terminal must be ensured. The smallest possible supply current should be set, depending on the sensor and cable length.

After switching on the 24 V supply voltage or connecting the sensor, a leakage current forms due to the input capacity on the high-pass filter. This current is based on the physical properties of electrolytic capacitors and is technically impossible to prevent. This current stabilizes at a constant value within a few minutes, and during the measurement it generates a constant offset of typically a few mV within the specified tolerance range. If this offset should prove to be disturbing when analyzing the measurement, it can be permanently and automatically subtracted out by activating the "Active offset adjustment" (object 0x80n0:21).

A shielded (simple or multiple) sensor cable must be used. The shield should be connected directly at the shield connections of the terminal.

The red error LED comes on and the error bit is set in the event of an open circuit or if no sensor is connected. If only the first channel is activated, the red LED for the second channel is disabled in SAFEOP and OP state.

Multi-channel IEPE sensors with a common GND can be connected to the EL3632 if the GND and AGND connection points are connected via an external bridge:

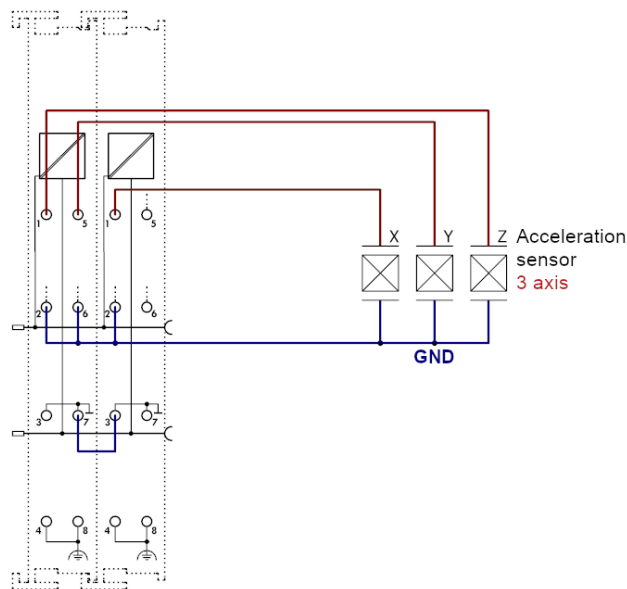

Unused inputs

Unused inputs must not be short-circuited.

Measuring error

Measuring error $< \pm 0,5\%$ (DC; relative to full scale value), taking into account the Butterworth characteristic.

5.4 Application example

NOTE



See documentation on EL3632

The documentation on EL3632 contains an application example that can also be used for EP3632-0001 and EPP3632-0001.

[Documentation on EL3632](#)

5.5 Error descriptions and troubleshooting

Error Codes

Error Index 0x6000:07	Underange Index 0x6000:01	Overrange Index 0x6000:02	TxPDO State Index 0x6000:0F	Sync Error Index 0x6000:0E	Error description	Remedy
1	1				Measurement is below range	Reduce the input level, change the gain (filter settings)
1		1			Measuring range exceeded	Reduce the input level, change the gain (filter settings)
1					General measuring error	e.g. open circuit
				1	Synchronization error	Jitter of master too high, distributed clocks switched off

The error LED lights up only in case of open circuit.

Troubleshooting

The dialog for setting the sampling rate is missing

The dialog for setting the sampling rate is missing. The TwinCAT System Manager uses the “online description” of the box. The note to use the dialog for the parameterization is only available in the XML description.

Solution: Make sure that the latest [XML description](#) is used.

The amplitude is too small

Filter settings incorrect.

Solution: Correct the settings in the CoE in the entries 0x80n0:15.

The box switches to SAFEOP

The box switches to SAFEOP. The real-time-settings are not accurate enough.

Solution: Use a PC without mobile chipset/CPU.

5.6 Restore the delivery state

You can restore the delivery state of the backup objects as follows:

1. Ensure that TwinCAT is running in Config mode.
2. In CoE object 1011:0 "Restore default parameters" select parameter 1011:01 "Subindex 001".

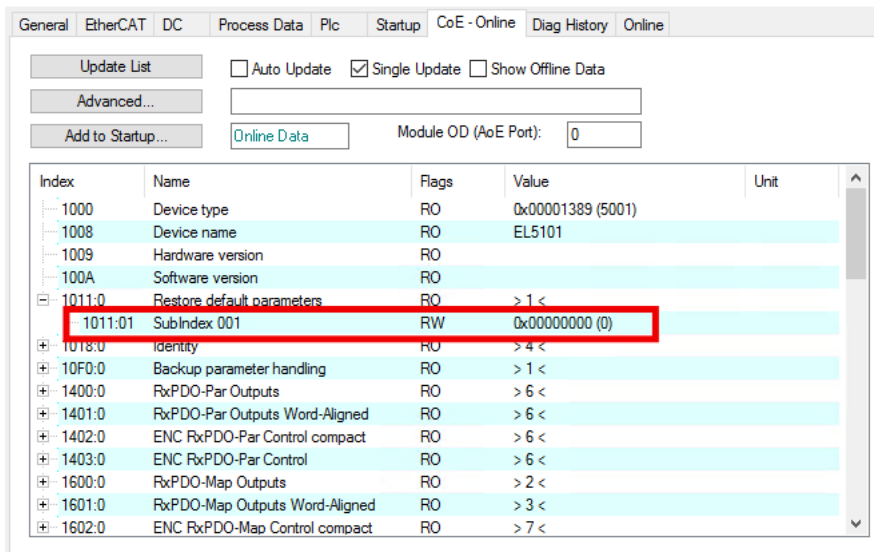

3. Double-click on "Subindex 001".
⇒ The "Set Value Dialog" dialog box opens.
4. Enter the value 1684107116 in the "Dec" field.
Alternatively: enter the value 0x64616F6C in the "Hex" field.

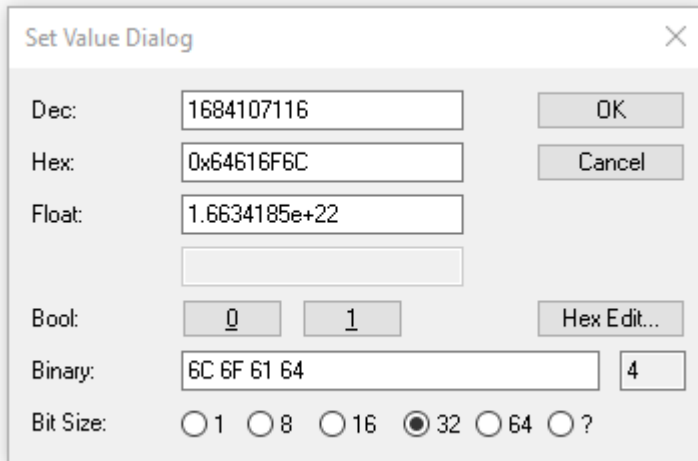

5. Confirm with "OK".
⇒ All backup objects are reset to the delivery state.

i Alternative restore value

With some older modules the backup objects can be changed with an alternative restore value:
 Decimal value: 1819238756
 Hexadecimal value: 0x6C6F6164

An incorrect entry for the restore value has no effect.

6 CoE parameters

6.1 Profile-specific and parameterization objects

i EtherCAT XML Device Description

The display matches that of the CoE objects from the EtherCAT XML Device Description. We recommend downloading the latest XML file from the download area of the [Beckhoff website](#) and installing it according to installation instructions.

i Parameterization via the CoE list (CAN over EtherCAT)

The EtherCAT device is parameterized via the CoE-Online tab (double-click on the respective object) or via the Process Data tab (allocation of PDOs). Please note the following general CoE notes when using/manipulating the CoE parameters:

- Keep a startup list if components have to be replaced
- Differentiation between online/offline dictionary, existence of current XML description
- use “CoE reload” for resetting changes

6.1.1 Restore object

Index 1011 Restore default parameters

Index (hex)	Name	Meaning	Data type	Flags	Default
1011:0	Restore default parameters	Restore default parameters	UINT8	RO	0x01 (1 _{dec})
1011:01	SubIndex 001	If this object is set to “ 0x64616F6C ” in the set value dialog, all backup objects are reset to their delivery state.	UINT32	RW	0x00000000 (0 _{dec})

6.1.2 Configuration data

Index 80n0 AI settings (for n = 0: channel 1; n = 1: channel 2)

Index (hex)	Name	Meaning	Data type	Flags	Default
80n0:0	AI Settings	Maximum subindex	UINT8	RO	0x20 (32 _{dec})
80n0:07	Enable limit	Activate limit evaluation (deviates from other EL terminals!)	BOOLEAN	RW	0x0 (FALSE)
80n0:0A	Enable user calibration	Enabling of the user calibration	BOOLEAN	RW	0x0 (FALSE)
80n0:0B	Enable vendor calibration	Enabling of the vendor calibration	BOOLEAN	RW	0x1 (TRUE)
80n0:13	Limit 1	Upper limit value	INT16	RW	0x0000 (0 _{dec})
80n0:14	Limit 2	Lower limit value	INT16	RW	0x0000 (0 _{dec})
80n0:15	Filter settings	Filter [52] settings 0: 10 Hz, Gain 20 1: 100 Hz 2: 500 Hz 3: 1000 Hz 4: 5000 Hz 5: 10000 Hz 6: 25000 Hz 7: 2000 Hz (from firmware 11)	ENUM	RW	10000 Hz (5)
80n0:17	User calibration offset	User calibration offset	INT16	RW	0
80n0:18	User calibration gain	User calibration gain factor	INT16	RW	16384
80n0:20	Supply current	Sensor current setting 0: 2 mA 1: 4 mA 2: 8 mA	ENUM	RW	2 mA (0)
80n0:21	Active offset adjustment	Automatic offset calculation [53] 0: Disabled 1: Level 1 2: Level 2 3: Level 3 4: Level 4 5: Level 5 6: Level 6 7: Level 7 8: Level 8	ENUM	RW	Disabled (0)

Index 80n8 AI advanced settings (for n = 0: channel 1; n = 1: channel 2)

Index (hex)	Name	Meaning	Data type	Flags	Default
80n8:0	AI Advanced Settings	Maximum subindex	UINT8	RO	0x06 (6 _{dec})
80n8:06	Input Amplifier	permitted values: 0: Preset (setting via object 0x80n0:15 [59]) 1: ON (switch-on of the analog amplifier x20 irrespective of filter settings; gain factor of 20 is not changeable) 2: OFF (switch-off of the analog amplifier irrespective of the filter settings)	BIT2	RW	0x00 (0 _{dec})

Index 8012 AI Device settings

Index (hex)	Name	Meaning	Data type	Flags	Default
8012:0	AI Device Settings	Maximum subindex	UINT8	RO	0x11 (17 _{dec})
8012:11	DC Timestamp Shift		UINT32	RW	0x00000000 (0 _{dec})

Index 80nF AI Vendor data (for n = 0: channel 1; n = 1: channel 2)

Index (hex)	Name	Meaning	Data type	Flags	Default
80nF:0	AI vendor data	Maximum subindex	UINT8	RO	0x04 (4 _{dec})
80nF:01	Calibration offset (gain 1)	Offset (vendor calibration), gain 1	INT16	RW	0x0000 (0 _{dec})
80nF:02	Calibration gain (gain 1)	Gain (vendor calibration), gain 1	INT16	RW	0x0000 (0 _{dec})
80nF:03	Calibration offset (gain 20)	Offset (vendor calibration), gain 20	INT16	RW	0x0000 (0 _{dec})
80nF:04	Calibration gain (gain 20)	Gain (vendor calibration), gain 20	INT16	RW	0x0000 (0 _{dec})

6.1.3 Command object**Index FB00 command**

Index (hex)	Name	Meaning	Data type	Flags	Default
FB00:0	DCM Command	Command interface	UINT8	RO	0x03 (3 _{dec})
FB00:01	Request	0x8000: Software reset, hardware is re-initialized with the current CoE configuration (this otherwise happens only during the transition to INIT)	OCTET-STRING[2]	RW	{0}
FB00:02	Status	0x8000: 0x01 if a reset has taken place	UINT8	RO	0x00 (0 _{dec})
FB00:03	Response	0x8000: not used	OCTET-STRING[4]	RO	{0}

6.1.4 Input data**Index 60n0 Status (for n = 0: channel 1; n = 1: channel 2)**

Index (hex)	Name	Meaning	Data type	Flags	Default
60n0:0	SAI Inputs	Maximum subindex	UINT8	RO	0x10 (16 _{dec})
60n0:01	Underrange	Indicates that the electrical measuring range is undershot	BOOLEAN	RO	0x00 (0 _{dec})
60n0:02	Overrange	Indicates that the electrical measuring range is exceeded	BOOLEAN	RO	0x00 (0 _{dec})
60n0:03	Limit 1	1: one or more values smaller than or equal to Limit 2 2: one or more values greater than or equal to Limit 1 3: 1 and 2 both true	BIT2	RO	0x00 (0 _{dec})
60n0:07	Error	Measuring error	BOOLEAN	RO	0x00 (0 _{dec})
60n0:0E	Sync error	Synchronization error	BOOLEAN	RO	0x00 (0 _{dec})
60n0:0F	TxPDO State	Validity of the data of the associated TxPDO (0 = valid, 1 = invalid).	BOOLEAN	RO	0x00 (0 _{dec})
60n0:10	TxPDO Toggle	A new measured value is available (if the toggle bit was changed). Status bits may be changed independent from the toggle bit.	BOOLEAN	RO	0x00 (0 _{dec})

Index 60n1 Samples (for n = 0: channel 1; n = 1: channel 2)

Index (hex)	Name	Meaning	Data type	Flags	Default
60n1:0	Samples	Maximum subindex	UINT8	RO	0x32 (50 _{dec})
60n1:01	Subindex 001	1. Sample	UINT16	RO P	0x0000 (0 _{dec})
...
60n1:32	Subindex 050	50. Sample	UINT16	RO P	0x0000 (0 _{dec})

Index 6020 Next Sync 1 Time

Index (hex)	Name	Meaning	Data type	Flags	Default
6020:0	Next Sync 1 Time	Maximum subindex	UINT8	RO	0x01 (1 _{dec})
6020:01	Start time next latch	DC timestamp of the next data set	UINT64	RO P	0x00 00 00 00 00 00 00 00 (0 _{dec})

Index 6021 Sample Count

Index (hex)	Name	Meaning	Data type	Flags	Default
6021:0	Sample Count	Maximum subindex	UINT8	RO	0x01 (1 _{dec})
6021:01	Sample Count	Sample counter (incremented with each ADC value)	UINT16	RO P	0x0000 (0 _{dec})

6.1.5 Information / diagnosis data (device-specific)

Index 10F3 Diagnosis History

Index (hex)	Name	Meaning	Data type	Flags	Default
10F3:0	Diagnosis History	Maximum subindex	UINT8	RO	0x15 (21 _{dec})
10F3:01	Maximum Messages	Maximum number of stored messages A maximum of 16 messages can be stored	UINT8	RO	0x00 (0 _{dec})
10F3:02	Newest Message	Subindex of the latest message	UINT8	RO	0x00 (0 _{dec})
10F3:03	Newest Acknowledged Message	Subindex of the last confirmed message	UINT8	RW	0x00 (0 _{dec})
10F3:04	New Messages Available	Indicates that a new message is available	BOOLEAN	RO	0x00 (0 _{dec})
10F3:05	Flags	not used	UINT16	RW	0x0000 (0 _{dec})
10F3:06	Diagnosis Message 001	Message 1	OCTET-STRING[20]	RO	{0}
...
10F3:15	Diagnosis Message 016	Message 16	OCTET-STRING[20]	RO	{0}

Index 10F8 Actual Time Stamp

Index (hex)	Name	Meaning	Data type	Flags	Default
10F8:0	Actual Time Stamp	Time stamp	UINT64	RO	

6.2 Standard objects and PDO mapping

● EtherCAT XML Device Description



The display matches that of the CoE objects from the EtherCAT XML Device Description. We recommend downloading the latest XML file from the download area of the Beckhoff website and installing it according to installation instructions.

● Parameterization via the CoE list (CAN over EtherCAT)



The EtherCAT device is parameterized via the CoE-Online tab (double-click on the respective object) or via the Process Data tab (allocation of PDOs). Please note the following general CoE notes when using/manipulating the CoE parameters:

- Keep a startup list if components have to be replaced
- Differentiation between online/offline dictionary, existence of current XML description
- use “CoE reload” for resetting changes

Index 1000 Device type

Index (hex)	Name	Meaning	Data type	Flags	Default
1000:0	Device type	Device type of the EtherCAT slave: The Lo-Word contains the CoE profile used (5001). The Hi-Word contains the module profile according to the modular device profile.	UINT32	RO	0x012C1389 (19665801 _{dec})

Index 1008 Device name

Index (hex)	Name	Meaning	Data type	Flags	Default
1008:0	Device name	Device name of the EtherCAT slave	STRING	RO	EP3632

Index 1009 Hardware version

Index (hex)	Name	Meaning	Data type	Flags	Default
1009:0	Hardware version	Hardware version of the EtherCAT slave	STRING	RO	

Index 100A Software version

Index (hex)	Name	Meaning	Data type	Flags	Default
100A:0	Software version	Firmware version of the EtherCAT slave	STRING	RO	05

Index 1018 Identity

Index (hex)	Name	Meaning	Data type	Flags	Default
1018:0	Identity	Information for identifying the slave	UINT8	RO	0x04 (4 _{dec})
1018:01	Vendor ID	Vendor ID of the EtherCAT slave	UINT32	RO	0x00000002 (2 _{dec})
1018:02	Product code	Product code of the EtherCAT slave	UINT32	RO	0x0E303052 (238039122 _{dec})
1018:03	Revision	Revision number of the EtherCAT slave; the low word (bit 0-15) indicates the special terminal number, the high word (bit 16-31) refers to the device description	UINT32	RO	0x00110000 (1114112 _{dec})
1018:04	Serial number	Serial number of the EtherCAT slave; the low byte (bit 0-7) of the low word contains the year of production, the high byte (bit 8-15) of the low word contains the week of production, the high word (bit 16-31) is 0	UINT32	RO	0x00000000 (0 _{dec})

Index 10F0 Backup parameter handling

Index (hex)	Name	Meaning	Data type	Flags	Default
10F0:0	Backup parameter handling	Information for standardized loading and saving of backup entries	UINT8	RO	0x01 (1 _{dec})
10F0:01	Checksum	Checksum across all backup entries of the EtherCAT slave	UINT32	RO	0x00000000 (0 _{dec})

Index 1A00 Analog Input TxPDO-Map Status Ch.1

Index (hex)	Name	Meaning	Data type	Flags	Default
1A00:0	Analog Input TxPDO-MapStatus Ch.1	PDO Mapping TxPDO 1	UINT8	RO	0x09 (9 _{dec})
1A00:01	SubIndex 001	1. PDO Mapping entry (object 0x6000 (Status), entry 0x01 (Underrange))	UINT32	RO	0x6000:01, 1
1A00:02	SubIndex 002	2. PDO Mapping entry (object 0x6000 (Status), entry 0x02 (Overrange))	UINT32	RO	0x6000:02, 1
1A00:03	SubIndex 003	3. PDO Mapping entry (object 0x6000 (Status), entry 0x03 (Limit 1))	UINT32	RO	0x6000:03, 2
1A00:04	SubIndex 004	4. PDO Mapping entry (object 0x6000 (Status), entry 0x05 (Limit 2))	UINT32	RO	0x6000:05, 2
1A00:05	SubIndex 005	5. PDO Mapping entry (object 0x6000 (Status), entry 0x07 (Error))	UINT32	RO	0x6000:07, 1
1A00:06	SubIndex 006	6. PDO Mapping entry (6 bits align)	UINT32	RO	0x0000:00, 6
1A00:07	SubIndex 007	7. PDO Mapping entry (object 0x6000 (Status), entry 0x0E (Sync error))	UINT32	RO	0x6000:0E, 1
1A00:08	SubIndex 008	8. PDO Mapping entry (object 0x6000 (Status), entry 0x0F (TxPDO State))	UINT32	RO	0x6000:0F, 1
1A00:09	SubIndex 009	9. PDO Mapping entry (object 0x6000 (Status), entry 0x10 (TxPDO Toggle))	UINT32	RO	0x6000:10, 1

Index 1A01 Analog Input TxPDO-MapSamples 1 Ch.1

Index (hex)	Name	Meaning	Data type	Flags	Default
1A01:0	Analog Input TxPDO-MapSamples 1 Ch.1	PDO Mapping TxPDO 2	UINT8	RO	0x01 (1 _{dec})
1A01:01	SubIndex 001	1. PDO Mapping entry (object 0x6001 (Samples), entry 0x01)	UINT32	RO	0x6001:01, 16

Index 1A02 Analog Input TxPDO-MapSamples 2 Ch.1

Index (hex)	Name	Meaning	Data type	Flags	Default
1A02:0	Analog Input TxPDO-MapSamples 2 Ch.1	PDO Mapping TxPDO 3	UINT8	RO	0x01 (1 _{dec})
1A02:01	SubIndex 001	1. PDO Mapping entry (object 0x6001 (Samples), entry 0x02 ())	UINT32	RO	0x6001:02, 16

Index 1A03 Analog Input TxPDO-MapSamples 3 Ch.1

Index (hex)	Name	Meaning	Data type	Flags	Default
1A03:0	Analog Input TxPDO-MapSamples 3 Ch.1	PDO Mapping TxPDO 4	UINT8	RO	0x01 (1 _{dec})
1A03:01	SubIndex 001	1. PDO Mapping entry (object 0x6001 (Samples), entry 0x03 ())	UINT32	RO	0x6001:03, 16

Index 1A04 Analog Input TxPDO-MapSamples 4 Ch.1

Index (hex)	Name	Meaning	Data type	Flags	Default
1A04:0	Analog Input TxPDO-MapSamples 4 Ch.1	PDO Mapping TxPDO 5	UINT8	RO	0x01 (1 _{dec})
1A04:01	SubIndex 001	1. PDO Mapping entry (object 0x6001 (Samples), entry 0x04 ())	UINT32	RO	0x6001:04, 16

Index 1A05 Analog Input TxPDO-MapSamples 5 Ch.1

Index (hex)	Name	Meaning	Data type	Flags	Default
1A05:0	Analog Input TxPDO-MapSamples 5 Ch.1	PDO Mapping TxPDO 6	UINT8	RO	0x01 (1 _{dec})
1A05:01	SubIndex 001	1. PDO Mapping entry (object 0x6001 (Samples), entry 0x05 ()))	UINT32	RO	0x6001:05, 16

Index 1A06 Analog Input TxPDO-MapSamples 6 Ch.1

Index (hex)	Name	Meaning	Data type	Flags	Default
1A06:0	Analog Input TxPDO-MapSamples 6 Ch.1	PDO Mapping TxPDO 7	UINT8	RO	0x01 (1 _{dec})
1A06:01	SubIndex 001	1. PDO Mapping entry (object 0x6001 (Samples), entry 0x06 ())	UINT32	RO	0x6001:06, 16

Index 1A07 Analog Input TxPDO-MapSamples 7 Ch.1

Index (hex)	Name	Meaning	Data type	Flags	Default
1A07:0	Analog Input TxPDO-MapSamples 7 Ch.1	PDO Mapping TxPDO 8	UINT8	RO	0x01 (1 _{dec})
1A07:01	SubIndex 001	1. PDO Mapping entry (object 0x6001 (Samples), entry 0x07 ())	UINT32	RO	0x6001:07, 16

Index 1A08 Analog Input TxPDO-MapSamples 8 Ch.1

Index (hex)	Name	Meaning	Data type	Flags	Default
1A08:0	Analog Input TxPDO-MapSamples 8 Ch.1	PDO Mapping TxPDO 9	UINT8	RO	0x01 (1 _{dec})
1A08:01	SubIndex 001	1. PDO Mapping entry (object 0x6001 (Samples), entry 0x08 ())	UINT32	RO	0x6001:08, 16

Index 1A09 Analog Input TxPDO-MapSamples 9 Ch.1

Index (hex)	Name	Meaning	Data type	Flags	Default
1A09:0	Analog Input TxPDO-MapSamples 9 Ch.1	PDO Mapping TxPDO 10	UINT8	RO	0x01 (1 _{dec})
1A09:01	SubIndex 001	1. PDO Mapping entry (object 0x6001 (Samples), entry 0x09 ())	UINT32	RO	0x6001:09, 16

Index 1A0A Analog Input TxPDO-MapSamples 10 Ch.1

Index (hex)	Name	Meaning	Data type	Flags	Default
1A0A:0	Analog Input TxPDO-MapSamples 10 Ch.1	PDO Mapping TxPDO 11	UINT8	RO	0x01 (1 _{dec})
1A0A:01	SubIndex 001	1. PDO Mapping entry (object 0x6001 (Samples), entry 0x0A ())	UINT32	RO	0x6001:0A, 16

Index 1A0B Analog Input TxPDO-MapSamples 11 Ch.1

Index (hex)	Name	Meaning	Data type	Flags	Default
1A0B:0	Analog Input TxPDO-MapSamples 11 Ch.1	PDO Mapping TxPDO 12	UINT8	RO	0x01 (1 _{dec})
1A0B:01	SubIndex 001	1. PDO Mapping entry (object 0x6001 (Samples), entry 0x0B ())	UINT32	RO	0x6001:0B, 16

Index 1A0C Analog Input TxPDO-MapSamples 12 Ch.1

Index (hex)	Name	Meaning	Data type	Flags	Default
1A0C:0	Analog Input TxPDO-MapSamples 12 Ch.1	PDO Mapping TxPDO 13	UINT8	RO	0x01 (1 _{dec})
1A0C:01	SubIndex 001	1. PDO Mapping entry (object 0x6001 (Samples), entry 0x0C ())	UINT32	RO	0x6001:0C, 16

Index 1A0D Analog Input TxPDO-MapSamples 13 Ch.1

Index (hex)	Name	Meaning	Data type	Flags	Default
1A0D:0	Analog Input TxPDO-MapSamples 13 Ch.1	PDO Mapping TxPDO 14	UINT8	RO	0x01 (1 _{dec})
1A0D:01	SubIndex 001	1. PDO Mapping entry (object 0x6001 (Samples), entry 0x0D ())	UINT32	RO	0x6001:0D, 16

Index 1A0E Analog Input TxPDO-MapSamples 14 Ch.1

Index (hex)	Name	Meaning	Data type	Flags	Default
1A0E:0	Analog Input TxPDO-MapSamples 14 Ch.1	PDO Mapping TxPDO 15	UINT8	RO	0x01 (1 _{dec})
1A0E:01	SubIndex 001	1. PDO Mapping entry (object 0x6001 (Samples), entry 0x0E ())	UINT32	RO	0x6001:0E, 16

Index 1A0F Analog Input TxPDO-MapSamples 15 Ch.1

Index (hex)	Name	Meaning	Data type	Flags	Default
1A0F:0	Analog Input TxPDO-MapSamples 15 Ch.1	PDO Mapping TxPDO 16	UINT8	RO	0x01 (1 _{dec})
1A0F:01	SubIndex 001	1. PDO Mapping entry (object 0x6001 (Samples), entry 0x0F ())	UINT32	RO	0x6001:0F, 16

Index 1A10 Analog Input TxPDO-MapSamples 16 Ch.1

Index (hex)	Name	Meaning	Data type	Flags	Default
1A10:0	Analog Input TxPDO-MapSamples 16 Ch.1	PDO Mapping TxPDO 17	UINT8	RO	0x01 (1 _{dec})
1A10:01	SubIndex 001	1. PDO Mapping entry (object 0x6001 (Samples), entry 0x10 ())	UINT32	RO	0x6001:10, 16

Index 1A11 Analog Input TxPDO-MapSamples 17 Ch.1

Index (hex)	Name	Meaning	Data type	Flags	Default
1A11:0	Analog Input TxPDO-MapSamples 17 Ch.1	PDO Mapping TxPDO 18	UINT8	RO	0x01 (1 _{dec})
1A11:01	SubIndex 001	1. PDO Mapping entry (object 0x6001 (Samples), entry 0x11 ())	UINT32	RO	0x6001:11, 16

Index 1A12 Analog Input TxPDO-MapSamples 18 Ch.1

Index (hex)	Name	Meaning	Data type	Flags	Default
1A12:0	Analog Input TxPDO-MapSamples 18 Ch.1	PDO Mapping TxPDO 19	UINT8	RO	0x01 (1 _{dec})
1A12:01	SubIndex 001	1. PDO Mapping entry (object 0x6001 (Samples), entry 0x12 ())	UINT32	RO	0x6001:12, 16

Index 1A13 Analog Input TxPDO-MapSamples 19 Ch.1

Index (hex)	Name	Meaning	Data type	Flags	Default
1A13:0	Analog Input TxPDO-MapSamples 19 Ch.1	PDO Mapping TxPDO 20	UINT8	RO	0x01 (1 _{dec})
1A13:01	SubIndex 001	1. PDO Mapping entry (object 0x6001 (Samples), entry 0x13 ())	UINT32	RO	0x6001:13, 16

Index 1A14 Analog Input TxPDO-MapSamples 20 Ch.1

Index (hex)	Name	Meaning	Data type	Flags	Default
1A14:0	Analog Input TxPDO-MapSamples 20 Ch.1	PDO Mapping TxPDO 21	UINT8	RO	0x01 (1 _{dec})
1A14:01	SubIndex 001	1. PDO Mapping entry (object 0x6001 (Samples), entry 0x14 ())	UINT32	RO	0x6001:14, 16

Index 1A15 Analog Input TxPDO-MapSamples 21 Ch.1

Index (hex)	Name	Meaning	Data type	Flags	Default
1A15:0	Analog Input TxPDO-MapSamples 21 Ch.1	PDO Mapping TxPDO 22	UINT8	RO	0x01 (1 _{dec})
1A15:01	SubIndex 001	1. PDO Mapping entry (object 0x6001 (Samples), entry 0x15 ())	UINT32	RO	0x6001:15, 16

Index 1A16 Analog Input TxPDO-MapSamples 22 Ch.1

Index (hex)	Name	Meaning	Data type	Flags	Default
1A16:0	Analog Input TxPDO-MapSamples 22 Ch.1	PDO Mapping TxPDO 23	UINT8	RO	0x01 (1 _{dec})
1A16:01	SubIndex 001	1. PDO Mapping entry (object 0x6001 (Samples), entry 0x16 ())	UINT32	RO	0x6001:16, 16

Index 1A17 Analog Input TxPDO-MapSamples 23 Ch.1

Index (hex)	Name	Meaning	Data type	Flags	Default
1A17:0	Analog Input TxPDO-MapSamples 23 Ch.1	PDO Mapping TxPDO 24	UINT8	RO	0x01 (1 _{dec})
1A17:01	SubIndex 001	1. PDO Mapping entry (object 0x6001 (Samples), entry 0x17 ())	UINT32	RO	0x6001:17, 16

Index 1A18 Analog Input TxPDO-MapSamples 24 Ch.1

Index (hex)	Name	Meaning	Data type	Flags	Default
1A18:0	Analog Input TxPDO-MapSamples 24 Ch.1	PDO Mapping TxPDO 25	UINT8	RO	0x01 (1 _{dec})
1A18:01	SubIndex 001	1. PDO Mapping entry (object 0x6001 (Samples), entry 0x18 ())	UINT32	RO	0x6001:18, 16

Index 1A19 Analog Input TxPDO-MapSamples 25 Ch.1

Index (hex)	Name	Meaning	Data type	Flags	Default
1A19:0	Analog Input TxPDO-MapSamples 25 Ch.1	PDO Mapping TxPDO 26	UINT8	RO	0x01 (1 _{dec})
1A19:01	SubIndex 001	1. PDO Mapping entry (object 0x6001 (Samples), entry 0x19 ())	UINT32	RO	0x6001:19, 16

Index 1A1A Analog Input TxPDO-MapSamples 26 Ch.1

Index (hex)	Name	Meaning	Data type	Flags	Default
1A1A:0	Analog Input TxPDO-MapSamples 26 Ch.1	PDO Mapping TxPDO 27	UINT8	RO	0x01 (1 _{dec})
1A1A:01	SubIndex 001	1. PDO Mapping entry (object 0x6001 (Samples), entry 0x1A ())	UINT32	RO	0x6001:1A, 16

Index 1A1B Analog Input TxPDO-MapSamples 27 Ch.1

Index (hex)	Name	Meaning	Data type	Flags	Default
1A1B:0	Analog Input TxPDO-MapSamples 27 Ch.1	PDO Mapping TxPDO 28	UINT8	RO	0x01 (1 _{dec})
1A1B:01	SubIndex 001	1. PDO Mapping entry (object 0x6001 (Samples), entry 0x1B ())	UINT32	RO	0x6001:1B, 16

Index 1A1C Analog Input TxPDO-MapSamples 28 Ch.1

Index (hex)	Name	Meaning	Data type	Flags	Default
1A1C:0	Analog Input TxPDO-MapSamples 28 Ch.1	PDO Mapping TxPDO 29	UINT8	RO	0x01 (1 _{dec})
1A1C:01	SubIndex 001	1. PDO Mapping entry (object 0x6001 (Samples), entry 0x1C ())	UINT32	RO	0x6001:1C, 16

Index 1A1D Analog Input TxPDO-MapSamples 29 Ch.1

Index (hex)	Name	Meaning	Data type	Flags	Default
1A1D:0	Analog Input TxPDO-MapSamples 29 Ch.1	PDO Mapping TxPDO 30	UINT8	RO	0x01 (1 _{dec})
1A1D:01	SubIndex 001	1. PDO Mapping entry (object 0x6001 (Samples), entry 0x1D ())	UINT32	RO	0x6001:1D, 16

Index 1A1E Analog Input TxPDO-MapSamples 30 Ch.1

Index (hex)	Name	Meaning	Data type	Flags	Default
1A1E:0	Analog Input TxPDO-MapSamples 30 Ch.1	PDO Mapping TxPDO 31	UINT8	RO	0x01 (1 _{dec})
1A1E:01	SubIndex 001	1. PDO Mapping entry (object 0x6001 (Samples), entry 0x1E ())	UINT32	RO	0x6001:1E, 16

Index 1A1F Analog Input TxPDO-MapSamples 31 Ch.1

Index (hex)	Name	Meaning	Data type	Flags	Default
1A1F:0	Analog Input TxPDO-MapSamples 31 Ch.1	PDO Mapping TxPDO 32	UINT8	RO	0x01 (1 _{dec})
1A1F:01	SubIndex 001	1. PDO Mapping entry (object 0x6001 (Samples), entry 0x1F ())	UINT32	RO	0x6001:1F, 16

Index 1A20 Analog Input TxPDO-MapSamples 32 Ch.1

Index (hex)	Name	Meaning	Data type	Flags	Default
1A20:0	Analog Input TxPDO-MapSamples 32 Ch.1	PDO Mapping TxPDO 33	UINT8	RO	0x01 (1 _{dec})
1A20:01	SubIndex 001	1. PDO Mapping entry (object 0x6001 (Samples), entry 0x20 ())	UINT32	RO	0x6001:20, 16

Index 1A21 Analog Input TxPDO-MapSamples 33 Ch.1

Index (hex)	Name	Meaning	Data type	Flags	Default
1A21:0	Analog Input TxPDO-MapSamples 33 Ch.1	PDO Mapping TxPDO 34	UINT8	RO	0x01 (1 _{dec})
1A21:01	SubIndex 001	1. PDO Mapping entry (object 0x6001 (Samples), entry 0x21 ())	UINT32	RO	0x6001:21, 16

Index 1A22 Analog Input TxPDO-MapSamples 34 Ch.1

Index (hex)	Name	Meaning	Data type	Flags	Default
1A22:0	Analog Input TxPDO-MapSamples 34 Ch.1	PDO Mapping TxPDO 35	UINT8	RO	0x01 (1 _{dec})
1A22:01	SubIndex 001	1. PDO Mapping entry (object 0x6001 (Samples), entry 0x22 ())	UINT32	RO	0x6001:22, 16

Index 1A23 Analog Input TxPDO-MapSamples 35 Ch.1

Index (hex)	Name	Meaning	Data type	Flags	Default
1A23:0	Analog Input TxPDO-MapSamples 35 Ch.1	PDO Mapping TxPDO 36	UINT8	RO	0x01 (1 _{dec})
1A23:01	SubIndex 001	1. PDO Mapping entry (object 0x6001 (Samples), entry 0x23 ())	UINT32	RO	0x6001:23, 16

Index 1A24 Analog Input TxPDO-MapSamples 36 Ch.1

Index (hex)	Name	Meaning	Data type	Flags	Default
1A24:0	Analog Input TxPDO-MapSamples 36 Ch.1	PDO Mapping TxPDO 37	UINT8	RO	0x01 (1 _{dec})
1A24:01	SubIndex 001	1. PDO Mapping entry (object 0x6001 (Samples), entry 0x24 ())	UINT32	RO	0x6001:24, 16

Index 1A25 Analog Input TxPDO-MapSamples 37 Ch.1

Index (hex)	Name	Meaning	Data type	Flags	Default
1A25:0	Analog Input TxPDO-MapSamples 37 Ch.1	PDO Mapping TxPDO 38	UINT8	RO	0x01 (1 _{dec})
1A25:01	SubIndex 001	1. PDO Mapping entry (object 0x6001 (Samples), entry 0x25 ())	UINT32	RO	0x6001:25, 16

Index 1A26 Analog Input TxPDO-MapSamples 38 Ch.1

Index (hex)	Name	Meaning	Data type	Flags	Default
1A26:0	Analog Input TxPDO-MapSamples 38 Ch.1	PDO Mapping TxPDO 39	UINT8	RO	0x01 (1 _{dec})
1A26:01	SubIndex 001	1. PDO Mapping entry (object 0x6001 (Samples), entry 0x26 ())	UINT32	RO	0x6001:26, 16

Index 1A27 Analog Input TxPDO-MapSamples 39 Ch.1

Index (hex)	Name	Meaning	Data type	Flags	Default
1A27:0	Analog Input TxPDO-MapSamples 39 Ch.1	PDO Mapping TxPDO 40	UINT8	RO	0x01 (1 _{dec})
1A27:01	SubIndex 001	1. PDO Mapping entry (object 0x6001 (Samples), entry 0x27 ())	UINT32	RO	0x6001:27, 16

Index 1A28 Analog Input TxPDO-MapSamples 40 Ch.1

Index (hex)	Name	Meaning	Data type	Flags	Default
1A28:0	Analog Input TxPDO-MapSamples 40 Ch.1	PDO Mapping TxPDO 41	UINT8	RO	0x01 (1 _{dec})
1A28:01	SubIndex 001	1. PDO Mapping entry (object 0x6001 (Samples), entry 0x28 ())	UINT32	RO	0x6001:28, 16

Index 1A29 Analog Input TxPDO-MapSamples 41 Ch.1

Index (hex)	Name	Meaning	Data type	Flags	Default
1A29:0	Analog Input TxPDO-MapSamples 41 Ch.1	PDO Mapping TxPDO 42	UINT8	RO	0x01 (1 _{dec})
1A29:01	SubIndex 001	1. PDO Mapping entry (object 0x6001 (Samples), entry 0x29 ())	UINT32	RO	0x6001:29, 16

Index 1A2A Analog Input TxPDO-MapSamples 42 Ch.1

Index (hex)	Name	Meaning	Data type	Flags	Default
1A2A:0	Analog Input TxPDO-MapSamples 42 Ch.1	PDO Mapping TxPDO 43	UINT8	RO	0x01 (1 _{dec})
1A2A:01	SubIndex 001	1. PDO Mapping entry (object 0x6001 (Samples), entry 0x2A ())	UINT32	RO	0x6001:2A, 16

Index 1A2B Analog Input TxPDO-MapSamples 43 Ch.1

Index (hex)	Name	Meaning	Data type	Flags	Default
1A2B:0	Analog Input TxPDO-MapSamples 43 Ch.1	PDO Mapping TxPDO 44	UINT8	RO	0x01 (1 _{dec})
1A2B:01	SubIndex 001	1. PDO Mapping entry (object 0x6001 (Samples), entry 0x2B ())	UINT32	RO	0x6001:2B, 16

Index 1A2C Analog Input TxPDO-MapSamples 44 Ch.1

Index (hex)	Name	Meaning	Data type	Flags	Default
1A2C:0	Analog Input TxPDO-MapSamples 44 Ch.1	PDO Mapping TxPDO 45	UINT8	RO	0x01 (1 _{dec})
1A2C:01	SubIndex 001	1. PDO Mapping entry (object 0x6001 (Samples), entry 0x2C ())	UINT32	RO	0x6001:2C, 16

Index 1A2D Analog Input TxPDO-MapSamples 45 Ch.1

Index (hex)	Name	Meaning	Data type	Flags	Default
1A2D:0	Analog Input TxPDO-MapSamples 45 Ch.1	PDO Mapping TxPDO 46	UINT8	RO	0x01 (1 _{dec})
1A2D:01	SubIndex 001	1. PDO Mapping entry (object 0x6001 (Samples), entry 0x2D ())	UINT32	RO	0x6001:2D, 16

Index 1A2E Analog Input TxPDO-MapSamples 46 Ch.1

Index (hex)	Name	Meaning	Data type	Flags	Default
1A2E:0	Analog Input TxPDO-MapSamples 46 Ch.1	PDO Mapping TxPDO 47	UINT8	RO	0x01 (1 _{dec})
1A2E:01	SubIndex 001	1. PDO Mapping entry (object 0x6001 (Samples), entry 0x2E ())	UINT32	RO	0x6001:2E, 16

Index 1A2F Analog Input TxPDO-MapSamples 47 Ch.1

Index (hex)	Name	Meaning	Data type	Flags	Default
1A2F:0	Analog Input TxPDO-MapSamples 47 Ch.1	PDO Mapping TxPDO 48	UINT8	RO	0x01 (1 _{dec})
1A2F:01	SubIndex 001	1. PDO Mapping entry (object 0x6001 (Samples), entry 0x2F ())	UINT32	RO	0x6001:2F, 16

Index 1A30 Analog Input TxPDO-MapSamples 48 Ch.1

Index (hex)	Name	Meaning	Data type	Flags	Default
1A30:0	Analog Input TxPDO-MapSamples 48 Ch.1	PDO Mapping TxPDO 49	UINT8	RO	0x01 (1 _{dec})
1A30:01	SubIndex 001	1. PDO Mapping entry (object 0x6001 (Samples), entry 0x30 ())	UINT32	RO	0x6001:30, 16

Index 1A31 Analog Input TxPDO-MapSamples 49 Ch.1

Index (hex)	Name	Meaning	Data type	Flags	Default
1A31:0	Analog Input TxPDO-MapSamples 49 Ch.1	PDO Mapping TxPDO 50	UINT8	RO	0x01 (1 _{dec})
1A31:01	SubIndex 001	1. PDO Mapping entry (object 0x6001 (Samples), entry 0x31 ())	UINT32	RO	0x6001:31, 16

Index 1A32 Analog Input TxPDO-MapSamples 50 Ch.1

Index (hex)	Name	Meaning	Data type	Flags	Default
1A32:0	Analog Input TxPDO-MapSamples 50 Ch.1	PDO Mapping TxPDO 51	UINT8	RO	0x01 (1 _{dec})
1A32:01	SubIndex 001	1. PDO Mapping entry (object 0x6001 (Samples), entry 0x32 ())	UINT32	RO	0x6001:32, 16

Index 1A40 Analog Input TxPDO-MapStatus Ch.2

Index (hex)	Name	Meaning	Data type	Flags	Default
1A40:0	Analog Input TxPDO-MapStatus Ch.2	PDO Mapping TxPDO 65	UINT8	RO	0x09 (9 _{dec})
1A40:01	SubIndex 001	1. PDO Mapping entry (object 0x6010 (Status), entry 0x01 (Underrange))	UINT32	RO	0x6010:01, 1
1A40:02	SubIndex 002	2. PDO Mapping entry (object 0x6010 (Status), entry 0x02 (Overrange))	UINT32	RO	0x6010:02, 1
1A40:03	SubIndex 003	3. PDO Mapping entry (object 0x6010 (Status), entry 0x03 (Limit 1))	UINT32	RO	0x6010:03, 2
1A40:04	SubIndex 004	4. PDO Mapping entry (object 0x6010 (Status), entry 0x05 (Limit 2))	UINT32	RO	0x6010:05, 2
1A40:05	SubIndex 005	5. PDO Mapping entry (object 0x6010 (Status), entry 0x07 (Error))	UINT32	RO	0x6010:07, 1
1A40:06	SubIndex 006	6. PDO Mapping entry (6 bits align)	UINT32	RO	0x0000:00, 6
1A40:07	SubIndex 007	7. PDO Mapping entry (object 0x6010 (Status), entry 0x0E (Sync error))	UINT32	RO	0x6010:0E, 1
1A40:08	SubIndex 008	8. PDO Mapping entry (object 0x6010 (Status), entry 0x0F (TxPDO State))	UINT32	RO	0x6010:0F, 1
1A40:09	SubIndex 009	9. PDO Mapping entry (object 0x6010 (Status), entry 0x10 (TxPDO Toggle))	UINT32	RO	0x6010:10, 1

Index 1A41 Analog Input TxPDO-MapSamples 1 Ch.2

Index (hex)	Name	Meaning	Data type	Flags	Default
1A41:0	Analog Input TxPDO-MapSamples 1 Ch.2	PDO Mapping TxPDO 66	UINT8	RO	0x01 (1 _{dec})
1A41:01	SubIndex 001	1. PDO Mapping entry (object 0x6011 (Samples), entry 0x01 ())	UINT32	RO	0x6011:01, 16

Index 1A42 Analog Input TxPDO-MapSamples 2 Ch.2

Index (hex)	Name	Meaning	Data type	Flags	Default
1A42:0	Analog Input TxPDO-MapSamples 2 Ch.2	PDO Mapping TxPDO 67	UINT8	RO	0x01 (1 _{dec})
1A42:01	SubIndex 001	1. PDO Mapping entry (object 0x6011 (Samples), entry 0x02 ())	UINT32	RO	0x6011:02, 16

Index 1A43 Analog Input TxPDO-MapSamples 3 Ch.2

Index (hex)	Name	Meaning	Data type	Flags	Default
1A43:0	Analog Input TxPDO-MapSamples 3 Ch.2	PDO Mapping TxPDO 68	UINT8	RO	0x01 (1 _{dec})
1A43:01	SubIndex 001	1. PDO Mapping entry (object 0x6011 (Samples), entry 0x03 ())	UINT32	RO	0x6011:03, 16

Index 1A44 Analog Input TxPDO-MapSamples 4 Ch.2

Index (hex)	Name	Meaning	Data type	Flags	Default
1A44:0	Analog Input TxPDO-MapSamples 4 Ch.2	PDO Mapping TxPDO 69	UINT8	RO	0x01 (1 _{dec})
1A44:01	SubIndex 001	1. PDO Mapping entry (object 0x6011 (Samples), entry 0x04 ())	UINT32	RO	0x6011:04, 16

Index 1A45 Analog Input TxPDO-MapSamples 5 Ch.2

Index (hex)	Name	Meaning	Data type	Flags	Default
1A45:0	Analog Input TxPDO-MapSamples 5 Ch.2	PDO Mapping TxPDO 70	UINT8	RO	0x01 (1 _{dec})
1A45:01	SubIndex 001	1. PDO Mapping entry (object 0x6011 (Samples), entry 0x05 ())	UINT32	RO	0x6011:05, 16

Index 1A46 Analog Input TxPDO-MapSamples 6 Ch.2

Index (hex)	Name	Meaning	Data type	Flags	Default
1A46:0	Analog Input TxPDO-MapSamples 6 Ch.2	PDO Mapping TxPDO 71	UINT8	RO	0x01 (1 _{dec})
1A46:01	SubIndex 001	1. PDO Mapping entry (object 0x6011 (Samples), entry 0x06 ())	UINT32	RO	0x6011:06, 16

Index 1A47 Analog Input TxPDO-MapSamples 7 Ch.2

Index (hex)	Name	Meaning	Data type	Flags	Default
1A47:0	Analog Input TxPDO-MapSamples 7 Ch.2	PDO Mapping TxPDO 72	UINT8	RO	0x01 (1 _{dec})
1A47:01	SubIndex 001	1. PDO Mapping entry (object 0x6011 (Samples), entry 0x07 ())	UINT32	RO	0x6011:07, 16

Index 1A48 Analog Input TxPDO-MapSamples 8 Ch.2

Index (hex)	Name	Meaning	Data type	Flags	Default
1A48:0	Analog Input TxPDO-MapSamples 8 Ch.2	PDO Mapping TxPDO 73	UINT8	RO	0x01 (1 _{dec})
1A48:01	SubIndex 001	1. PDO Mapping entry (object 0x6011 (Samples), entry 0x08 ())	UINT32	RO	0x6011:08, 16

Index 1A49 Analog Input TxPDO-MapSamples 9 Ch.2

Index (hex)	Name	Meaning	Data type	Flags	Default
1A49:0	Analog Input TxPDO-MapSamples 9 Ch.2	PDO Mapping TxPDO 74	UINT8	RO	0x01 (1 _{dec})
1A49:01	SubIndex 001	1. PDO Mapping entry (object 0x6011 (Samples), entry 0x09 ())	UINT32	RO	0x6011:09, 16

Index 1A4A Analog Input TxPDO-MapSamples 10 Ch.2

Index (hex)	Name	Meaning	Data type	Flags	Default
1A4A:0	Analog Input TxPDO-MapSamples 10 Ch.2	PDO Mapping TxPDO 75	UINT8	RO	0x01 (1 _{dec})
1A4A:01	SubIndex 001	1. PDO Mapping entry (object 0x6011 (Samples), entry 0x0A ())	UINT32	RO	0x6011:0A, 16

Index 1A4B Analog Input TxPDO-MapSamples 11 Ch.2

Index (hex)	Name	Meaning	Data type	Flags	Default
1A4B:0	Analog Input TxPDO-MapSamples 11 Ch.2	PDO Mapping TxPDO 76	UINT8	RO	0x01 (1 _{dec})
1A4B:01	SubIndex 001	1. PDO Mapping entry (object 0x6011 (Samples), entry 0x0B ())	UINT32	RO	0x6011:0B, 16

Index 1A4C Analog Input TxPDO-MapSamples 12 Ch.2

Index (hex)	Name	Meaning	Data type	Flags	Default
1A4C:0	Analog Input TxPDO-MapSamples 12 Ch.2	PDO Mapping TxPDO 77	UINT8	RO	0x01 (1 _{dec})
1A4C:01	SubIndex 001	1. PDO Mapping entry (object 0x6011 (Samples), entry 0x0C ())	UINT32	RO	0x6011:0C, 16

Index 1A4D Analog Input TxPDO-MapSamples 13 Ch.2

Index (hex)	Name	Meaning	Data type	Flags	Default
1A4D:0	Analog Input TxPDO-MapSamples 13 Ch.2	PDO Mapping TxPDO 78	UINT8	RO	0x01 (1 _{dec})
1A4D:01	SubIndex 001	1. PDO Mapping entry (object 0x6011 (Samples), entry 0x0D ())	UINT32	RO	0x6011:0D, 16

Index 1A4E Analog Input TxPDO-MapSamples 14 Ch.2

Index (hex)	Name	Meaning	Data type	Flags	Default
1A4E:0	Analog Input TxPDO-MapSamples 14 Ch.2	PDO Mapping TxPDO 79	UINT8	RO	0x01 (1 _{dec})
1A4E:01	SubIndex 001	1. PDO Mapping entry (object 0x6011 (Samples), entry 0x0E ())	UINT32	RO	0x6011:0E, 16

Index 1A4F Analog Input TxPDO-MapSamples 15 Ch.2

Index (hex)	Name	Meaning	Data type	Flags	Default
1A4F:0	Analog Input TxPDO-MapSamples 15 Ch.2	PDO Mapping TxPDO 80	UINT8	RO	0x01 (1 _{dec})
1A4F:01	SubIndex 001	1. PDO Mapping entry (object 0x6011 (Samples), entry 0x0F ())	UINT32	RO	0x6011:0F, 16

Index 1A50 Analog Input TxPDO-MapSamples 16 Ch.2

Index (hex)	Name	Meaning	Data type	Flags	Default
1A50:0	Analog Input TxPDO-MapSamples 16 Ch.2	PDO Mapping TxPDO 81	UINT8	RO	0x01 (1 _{dec})
1A50:01	SubIndex 001	1. PDO Mapping entry (object 0x6011 (Samples), entry 0x10 ())	UINT32	RO	0x6011:10, 16

Index 1A51 Analog Input TxPDO-MapSamples 17 Ch.2

Index (hex)	Name	Meaning	Data type	Flags	Default
1A51:0	Analog Input TxPDO-MapSamples 17 Ch.2	PDO Mapping TxPDO 82	UINT8	RO	0x01 (1 _{dec})
1A51:01	SubIndex 001	1. PDO Mapping entry (object 0x6011 (Samples), entry 0x11 ())	UINT32	RO	0x6011:11, 16

Index 1A52 Analog Input TxPDO-MapSamples 18 Ch.2

Index (hex)	Name	Meaning	Data type	Flags	Default
1A52:0	Analog Input TxPDO-MapSamples 18 Ch.2	PDO Mapping TxPDO 83	UINT8	RO	0x01 (1 _{dec})
1A52:01	SubIndex 001	1. PDO Mapping entry (object 0x6011 (Samples), entry 0x12 ())	UINT32	RO	0x6011:12, 16

Index 1A53 Analog Input TxPDO-MapSamples 19 Ch.2

Index (hex)	Name	Meaning	Data type	Flags	Default
1A53:0	Analog Input TxPDO-MapSamples 19 Ch.2	PDO Mapping TxPDO 84	UINT8	RO	0x01 (1 _{dec})
1A53:01	SubIndex 001	1. PDO Mapping entry (object 0x6011 (Samples), entry 0x13 ())	UINT32	RO	0x6011:13, 16

Index 1A54 Analog Input TxPDO-MapSamples 20 Ch.2

Index (hex)	Name	Meaning	Data type	Flags	Default
1A54:0	Analog Input TxPDO-MapSamples 20 Ch.2	PDO Mapping TxPDO 85	UINT8	RO	0x01 (1 _{dec})
1A54:01	SubIndex 001	1. PDO Mapping entry (object 0x6011 (Samples), entry 0x14 ())	UINT32	RO	0x6011:14, 16

Index 1A55 Analog Input TxPDO-MapSamples 21 Ch.2

Index (hex)	Name	Meaning	Data type	Flags	Default
1A55:0	Analog Input TxPDO-MapSamples 21 Ch.2	PDO Mapping TxPDO 86	UINT8	RO	0x01 (1 _{dec})
1A55:01	SubIndex 001	1. PDO Mapping entry (object 0x6011 (Samples), entry 0x15 ())	UINT32	RO	0x6011:15, 16

Index 1A56 Analog Input TxPDO-MapSamples 22 Ch.2

Index (hex)	Name	Meaning	Data type	Flags	Default
1A56:0	Analog Input TxPDO-MapSamples 22 Ch.2	PDO Mapping TxPDO 87	UINT8	RO	0x01 (1 _{dec})
1A56:01	SubIndex 001	1. PDO Mapping entry (object 0x6011 (Samples), entry 0x16 ())	UINT32	RO	0x6011:16, 16

Index 1A57 Analog Input TxPDO-MapSamples 23 Ch.2

Index (hex)	Name	Meaning	Data type	Flags	Default
1A57:0	Analog Input TxPDO-MapSamples 23 Ch.2	PDO Mapping TxPDO 88	UINT8	RO	0x01 (1 _{dec})
1A57:01	SubIndex 001	1. PDO Mapping entry (object 0x6011 (Samples), entry 0x17 ())	UINT32	RO	0x6011:17, 16

Index 1A58 Analog Input TxPDO-MapSamples 24 Ch.2

Index (hex)	Name	Meaning	Data type	Flags	Default
1A58:0	Analog Input TxPDO-MapSamples 24 Ch.2	PDO Mapping TxPDO 89	UINT8	RO	0x01 (1 _{dec})
1A58:01	SubIndex 001	1. PDO Mapping entry (object 0x6011 (Samples), entry 0x18 ())	UINT32	RO	0x6011:18, 16

Index 1A59 Analog Input TxPDO-MapSamples 25 Ch.2

Index (hex)	Name	Meaning	Data type	Flags	Default
1A59:0	Analog Input TxPDO-MapSamples 25 Ch.2	PDO Mapping TxPDO 90	UINT8	RO	0x01 (1 _{dec})
1A59:01	SubIndex 001	1. PDO Mapping entry (object 0x6011 (Samples), entry 0x19 ())	UINT32	RO	0x6011:19, 16

Index 1A5A Analog Input TxPDO-MapSamples 26 Ch.2

Index (hex)	Name	Meaning	Data type	Flags	Default
1A5A:0	Analog Input TxPDO-MapSamples 26 Ch.2	PDO Mapping TxPDO 91	UINT8	RO	0x01 (1 _{dec})
1A5A:01	SubIndex 001	1. PDO Mapping entry (object 0x6011 (Samples), entry 0x1A ())	UINT32	RO	0x6011:1A, 16

Index 1A5B Analog Input TxPDO-MapSamples 27 Ch.2

Index (hex)	Name	Meaning	Data type	Flags	Default
1A5B:0	Analog Input TxPDO-MapSamples 27 Ch.2	PDO Mapping TxPDO 92	UINT8	RO	0x01 (1 _{dec})
1A5B:01	SubIndex 001	1. PDO Mapping entry (object 0x6011 (Samples), entry 0x1B ())	UINT32	RO	0x6011:1B, 16

Index 1A5C Analog Input TxPDO-MapSamples 28 Ch.2

Index (hex)	Name	Meaning	Data type	Flags	Default
1A5C:0	Analog Input TxPDO-MapSamples 28 Ch.2	PDO Mapping TxPDO 93	UINT8	RO	0x01 (1 _{dec})
1A5C:01	SubIndex 001	1. PDO Mapping entry (object 0x6011 (Samples), entry 0x1C ())	UINT32	RO	0x6011:1C, 16

Index 1A5D Analog Input TxPDO-MapSamples 29 Ch.2

Index (hex)	Name	Meaning	Data type	Flags	Default
1A5D:0	Analog Input TxPDO-MapSamples 29 Ch.2	PDO Mapping TxPDO 94	UINT8	RO	0x01 (1 _{dec})
1A5D:01	SubIndex 001	1. PDO Mapping entry (object 0x6011 (Samples), entry 0x1D ())	UINT32	RO	0x6011:1D, 16

Index 1A5E Analog Input TxPDO-MapSamples 30 Ch.2

Index (hex)	Name	Meaning	Data type	Flags	Default
1A5E:0	Analog Input TxPDO-MapSamples 30 Ch.2	PDO Mapping TxPDO 95	UINT8	RO	0x01 (1 _{dec})
1A5E:01	SubIndex 001	1. PDO Mapping entry (object 0x6011 (Samples), entry 0x1E ())	UINT32	RO	0x6011:1E, 16

Index 1A5F Analog Input TxPDO-MapSamples 31 Ch.2

Index (hex)	Name	Meaning	Data type	Flags	Default
1A5F:0	Analog Input TxPDO-MapSamples 31 Ch.2	PDO Mapping TxPDO 96	UINT8	RO	0x01 (1 _{dec})
1A5F:01	SubIndex 001	1. PDO Mapping entry (object 0x6011 (Samples), entry 0x1F ())	UINT32	RO	0x6011:1F, 16

Index 1A60 Analog Input TxPDO-MapSamples 32 Ch.2

Index (hex)	Name	Meaning	Data type	Flags	Default
1A60:0	Analog Input TxPDO-MapSamples 32 Ch.2	PDO Mapping TxPDO 97	UINT8	RO	0x01 (1 _{dec})
1A60:01	SubIndex 001	1. PDO Mapping entry (object 0x6011 (Samples), entry 0x20 ())	UINT32	RO	0x6011:20, 16

Index 1A61 Analog Input TxPDO-MapSamples 33 Ch.2

Index (hex)	Name	Meaning	Data type	Flags	Default
1A61:0	Analog Input TxPDO-MapSamples 33 Ch.2	PDO Mapping TxPDO 98	UINT8	RO	0x01 (1 _{dec})
1A61:01	SubIndex 001	1. PDO Mapping entry (object 0x6011 (Samples), entry 0x21 ())	UINT32	RO	0x6011:21, 16

Index 1A62 Analog Input TxPDO-MapSamples 34 Ch.2

Index (hex)	Name	Meaning	Data type	Flags	Default
1A62:0	Analog Input TxPDO-MapSamples 34 Ch.2	PDO Mapping TxPDO 99	UINT8	RO	0x01 (1 _{dec})
1A62:01	SubIndex 001	1. PDO Mapping entry (object 0x6011 (Samples), entry 0x22 ())	UINT32	RO	0x6011:22, 16

Index 1A63 Analog Input TxPDO-MapSamples 35 Ch.2

Index (hex)	Name	Meaning	Data type	Flags	Default
1A63:0	Analog Input TxPDO-MapSamples 35 Ch.2	PDO Mapping TxPDO 100	UINT8	RO	0x01 (1 _{dec})
1A63:01	SubIndex 001	1. PDO Mapping entry (object 0x6011 (Samples), entry 0x23 ())	UINT32	RO	0x6011:23, 16

Index 1A64 Analog Input TxPDO-MapSamples 36 Ch.2

Index (hex)	Name	Meaning	Data type	Flags	Default
1A64:0	Analog Input TxPDO-MapSamples 36 Ch.2	PDO Mapping TxPDO 101	UINT8	RO	0x01 (1 _{dec})
1A64:01	SubIndex 001	1. PDO Mapping entry (object 0x6011 (Samples), entry 0x24 ())	UINT32	RO	0x6011:24, 16

Index 1A65 Analog Input TxPDO-MapSamples 37 Ch.2

Index (hex)	Name	Meaning	Data type	Flags	Default
1A65:0	Analog Input TxPDO-MapSamples 37 Ch.2	PDO Mapping TxPDO 102	UINT8	RO	0x01 (1 _{dec})
1A65:01	SubIndex 001	1. PDO Mapping entry (object 0x6011 (Samples), entry 0x25 ())	UINT32	RO	0x6011:25, 16

Index 1A66 Analog Input TxPDO-MapSamples 38 Ch.2

Index (hex)	Name	Meaning	Data type	Flags	Default
1A66:0	Analog Input TxPDO-MapSamples 38 Ch.2	PDO Mapping TxPDO 103	UINT8	RO	0x01 (1 _{dec})
1A66:01	SubIndex 001	1. PDO Mapping entry (object 0x6011 (Samples), entry 0x26 ())	UINT32	RO	0x6011:26, 16

Index 1A67 Analog Input TxPDO-MapSamples 39 Ch.2

Index (hex)	Name	Meaning	Data type	Flags	Default
1A67:0	Analog Input TxPDO-MapSamples 39 Ch.2	PDO Mapping TxPDO 104	UINT8	RO	0x01 (1 _{dec})
1A67:01	SubIndex 001	1. PDO Mapping entry (object 0x6011 (Samples), entry 0x27 ())	UINT32	RO	0x6011:27, 16

Index 1A68 Analog Input TxPDO-MapSamples 40 Ch.2

Index (hex)	Name	Meaning	Data type	Flags	Default
1A68:0	Analog Input TxPDO-MapSamples 40 Ch.2	PDO Mapping TxPDO 105	UINT8	RO	0x01 (1 _{dec})
1A68:01	SubIndex 001	1. PDO Mapping entry (object 0x6011 (Samples), entry 0x28 ())	UINT32	RO	0x6011:28, 16

Index 1A69 Analog Input TxPDO-MapSamples 41 Ch.2

Index (hex)	Name	Meaning	Data type	Flags	Default
1A69:0	Analog Input TxPDO-MapSamples 41 Ch.2	PDO Mapping TxPDO 106	UINT8	RO	0x01 (1 _{dec})
1A69:01	SubIndex 001	1. PDO Mapping entry (object 0x6011 (Samples), entry 0x29 ())	UINT32	RO	0x6011:29, 16

Index 1A6A Analog Input TxPDO-MapSamples 42 Ch.2

Index (hex)	Name	Meaning	Data type	Flags	Default
1A6A:0	Analog Input TxPDO-MapSamples 42 Ch.2	PDO Mapping TxPDO 107	UINT8	RO	0x01 (1 _{dec})
1A6A:01	SubIndex 001	1. PDO Mapping entry (object 0x6011 (Samples), entry 0x2A ())	UINT32	RO	0x6011:2A, 16

Index 1A6B Analog Input TxPDO-MapSamples 43 Ch.2

Index (hex)	Name	Meaning	Data type	Flags	Default
1A6B:0	Analog Input TxPDO-MapSamples 43 Ch.2	PDO Mapping TxPDO 108	UINT8	RO	0x01 (1 _{dec})
1A6B:01	SubIndex 001	1. PDO Mapping entry (object 0x6011 (Samples), entry 0x2B ())	UINT32	RO	0x6011:2B, 16

Index 1A6C Analog Input TxPDO-MapSamples 44 Ch.2

Index (hex)	Name	Meaning	Data type	Flags	Default
1A6C:0	Analog Input TxPDO-MapSamples 44 Ch.2	PDO Mapping TxPDO 109	UINT8	RO	0x01 (1 _{dec})
1A6C:01	SubIndex 001	1. PDO Mapping entry (object 0x6011 (Samples), entry 0x2C ())	UINT32	RO	0x6011:2C, 16

Index 1A6D Analog Input TxPDO-MapSamples 45 Ch.2

Index (hex)	Name	Meaning	Data type	Flags	Default
1A6D:0	Analog Input TxPDO-MapSamples 45 Ch.2	PDO Mapping TxPDO 110	UINT8	RO	0x01 (1 _{dec})
1A6D:01	SubIndex 001	1. PDO Mapping entry (object 0x6011 (Samples), entry 0x2D ())	UINT32	RO	0x6011:2D, 16

Index 1A6E Analog Input TxPDO-MapSamples 46 Ch.2

Index (hex)	Name	Meaning	Data type	Flags	Default
1A6E:0	Analog Input TxPDO-MapSamples 46 Ch.2	PDO Mapping TxPDO 111	UINT8	RO	0x01 (1 _{dec})
1A6E:01	SubIndex 001	1. PDO Mapping entry (object 0x6011 (Samples), entry 0x2E ())	UINT32	RO	0x6011:2E, 16

Index 1A6F Analog Input TxPDO-MapSamples 47 Ch.2

Index (hex)	Name	Meaning	Data type	Flags	Default
1A6F:0	Analog Input TxPDO-MapSamples 47 Ch.2	PDO Mapping TxPDO 112	UINT8	RO	0x01 (1 _{dec})
1A6F:01	SubIndex 001	1. PDO Mapping entry (object 0x6011 (Samples), entry 0x2F ())	UINT32	RO	0x6011:2F, 16

Index 1A70 Analog Input TxPDO-MapSamples 48 Ch.2

Index (hex)	Name	Meaning	Data type	Flags	Default
1A70:0	Analog Input TxPDO-MapSamples 48 Ch.2	PDO Mapping TxPDO 113	UINT8	RO	0x01 (1 _{dec})
1A70:01	SubIndex 001	1. PDO Mapping entry (object 0x6011 (Samples), entry 0x30 ())	UINT32	RO	0x6011:30, 16

Index 1A71 Analog Input TxPDO-MapSamples 49 Ch.2

Index (hex)	Name	Meaning	Data type	Flags	Default
1A71:0	Analog Input TxPDO-MapSamples 49 Ch.2	PDO Mapping TxPDO 114	UINT8	RO	0x01 (1 _{dec})
1A71:01	SubIndex 001	1. PDO Mapping entry (object 0x6011 (Samples), entry 0x31 ())	UINT32	RO	0x6011:31, 16

Index 1A72 Analog Input TxPDO-MapSamples 50 Ch.2

Index (hex)	Name	Meaning	Data type	Flags	Default
1A72:0	Analog Input TxPDO-MapSamples 50 Ch.2	PDO Mapping TxPDO 115	UINT8	RO	0x01 (1 _{dec})
1A72:01	SubIndex 001	1. PDO Mapping entry (object 0x6011 (Samples), entry 0x32 ())	UINT32	RO	0x6011:32, 16

Index 1A80 Analog Input Timestamp TxPDO-Map NextSync1Time

Index (hex)	Name	Meaning	Data type	Flags	Default
1A80:0	Analog Input Time-stamp TxPDO-Map NextSync1Time	PDO Mapping TxPDO 129	UINT8	RO	0x01 (1 _{dec})
1A80:01	SubIndex 001	1. PDO Mapping entry (object 0x6020 (NextSync1Time), entry 0x01 ())	UINT32	RO	0x6020:01, 64

Index 1A81 Analog Input Timestamp TxPDO-Map Sample Count

Index (hex)	Name	Meaning	Data type	Flags	Default
1A81:0	Analog Input Time-stamp TxPDO-Map Sample Count	PDO Mapping TxPDO 130	UINT8	RO	0x01 (1 _{dec})
1A81:01	SubIndex 001	1. PDO Mapping entry (object 0x6021 (SampleCount), entry 0x01 (Sample Count))	UINT32	RO	0x6021:01, 16

Index 1C00 Sync manager type

Index (hex)	Name	Meaning	Data type	Flags	Default
1C00:0	Sync manager type	Using the sync managers	UINT8	RO	0x04 (4 _{dec})
1C00:01	SubIndex 001	Sync-Manager Type Channel 1: Mailbox Write	UINT8	RO	0x01 (1 _{dec})
1C00:02	SubIndex 002	Sync-Manager Type Channel 2: Mailbox Read	UINT8	RO	0x02 (2 _{dec})
1C00:03	SubIndex 003	Sync-Manager Type Channel 3: Process Data Write (Outputs)	UINT8	RO	0x03 (3 _{dec})
1C00:04	SubIndex 004	Sync-Manager Type Channel 4: Process Data Read (Inputs)	UINT8	RO	0x04 (4 _{dec})

Index 1C12 RxPDO assign

Index (hex)	Name	Meaning	Data type	Flags	Default
1C12:0	RxPDO assign	PDO Assign Outputs	UINT8	RW	0x00 (0 _{dec})

Index 1C13 TxPDO assign

Index (hex)	Name	Meaning	Data type	Flags	Default
1C13:0	TxPDO assign	PDO Assign Inputs	UINT8	RW	0x06 (6 _{dec})
1C13:01	Subindex 001	1. allocated TxPDO (contains the index of the associated TxPDO mapping object)	UINT16	RW	0x1A00 (6656 _{dec})
1C13:02	Subindex 002	2. allocated TxPDO (contains the index of the associated TxPDO mapping object)	UINT16	RW	0x1A01 (6657 _{dec})
1C13:03	Subindex 003	3. allocated TxPDO (contains the index of the associated TxPDO mapping object)	UINT16	RW	0x1A40 (6720 _{dec})
1C13:04	Subindex 004	4. allocated TxPDO (contains the index of the associated TxPDO mapping object)	UINT16	RW	0x1A41 (6721 _{dec})
1C13:05	Subindex 005	5. allocated TxPDO (contains the index of the associated TxPDO mapping object)	UINT16	RW	0x1A80 (6784 _{dec})
1C13:06	Subindex 006	6. allocated TxPDO (contains the index of the associated TxPDO mapping object)	UINT16	RW	0x1A81 (6785 _{dec})
1C13:07	Subindex 007	7. allocated TxPDO (contains the index of the associated TxPDO mapping object)	UINT16	RW	0x0000 (0 _{dec})
1C13:69	Subindex 105	105. allocated TxPDO (contains the index of the associated TxPDO mapping object)	UINT16	RW	0x0000 (0 _{dec})

Index 1C33 SM input parameter

Index (hex)	Name	Meaning	Data type	Flags	Default
1C33:0	SM input parameter	Synchronization parameters for the inputs	UINT8	RO	0x20 (32 _{dec})
1C33:01	Sync mode	Current synchronization mode: <ul style="list-style-type: none"> • 0: Free Run • 1: Synchron with SM 3 Event (no outputs available) • 2: DC - Synchron with SYNC0 Event • 3: DC - Synchron with SYNC1 Event • 34: Synchron with SM 2 Event (outputs available) 	UINT16	RW	0x0022 (34 _{dec})
1C33:02	Cycle time	as 0x1C32:02	UINT32	RW	0x000F4240 (1000000 _{dec})
1C33:03	Shift time	Time between SYNC0 event and reading of the inputs (in ns, only DC mode)	UINT32	RO	0x00000000 (0 _{dec})
1C33:04	Sync modes supported	Supported synchronization modes: <ul style="list-style-type: none"> • Bit 0: free run is supported • Bit 1: Synchronous with SM 2 Event is supported (outputs available) • Bit 1: Synchronous with SM 3 Event is supported (no outputs available) • Bit 2-3 = 01: DC mode is supported • Bit 4-5 = 01: input shift through local event (outputs available) • Bit 4-5 = 10: input shift with SYNC1 event (no outputs available) • Bit 14 = 1: dynamic times (measurement through writing of 0x1C32:08 or 0x1C33:08) 	UINT16	RO	0x0C06 (3078 _{dec})
1C33:05	Minimum cycle time	as 0x1C32:05	UINT32	RO	0x00002710 (10000 _{dec})
1C33:06	Calc and copy time	Time between reading of the inputs and availability of the inputs for the master (in ns, only DC mode)	UINT32	RO	0x00000000 (0 _{dec})
1C33:07	Minimum delay time		UINT32	RO	0x00000000 (0 _{dec})
1C33:08	Command	as 0x1C32:08	UINT16	RW	0x0000 (0 _{dec})
1C33:09	Maximum delay time	Time between SYNC1 event and reading of the inputs (in ns, only DC mode)	UINT32	RO	0x00000000 (0 _{dec})
1C33:0B	SM event missed counter	as 0x1C32:11	UINT16	RO	0x0000 (0 _{dec})
1C33:0C	Cycle exceeded counter	as 0x1C32:12	UINT16	RO	0x0000 (0 _{dec})
1C33:0D	Shift too short counter	as 0x1C32:13	UINT16	RO	0x0000 (0 _{dec})
1C33:20	Sync error	as 0x1C32:32	BOOLEAN	RO	0x00 (0 _{dec})

Index F000 Modular device profile

Index (hex)	Name	Meaning	Data type	Flags	Default
F000:0	Modular device profile	General information for the modular device profile	UINT8	RO	0x02 (2 _{dec})
F000:01	Module index distance	Index distance of the objects of the individual channels	UINT16	RO	0x0010 (16 _{dec})
F000:02	Maximum number of modules	Number of channels	UINT16	RO	0x0003 (3 _{dec})

Index F008 Code word

Index (hex)	Name	Meaning	Data type	Flags	Default
F008:0	Code word	reserved	UINT32	RW	0x00000000 (0 _{dec})

Index F010 Module list

Index (hex)	Name	Meaning	Data type	Flags	Default
F010:0	Module list	Maximum subindex	UINT8	RW	0x03 (3 _{dec})
F010:01	SubIndex 001	Profile AI	UINT32	RW	0x0000012C (300 _{dec})
F010:02	SubIndex 002	Profile AI	UINT32	RW	0x0000012C (300 _{dec})
F010:03	SubIndex 003	Profile AI	UINT32	RW	0x0000012C (300 _{dec})

7 Appendix

7.1 General operating conditions

Protection degrees (IP-Code)

The standard IEC 60529 (DIN EN 60529) defines the degrees of protection in different classes.

1. Number: dust protection and touch guard	Definition
0	Non-protected
1	Protected against access to hazardous parts with the back of a hand. Protected against solid foreign objects of Ø 50 mm
2	Protected against access to hazardous parts with a finger. Protected against solid foreign objects of Ø 12.5 mm.
3	Protected against access to hazardous parts with a tool. Protected against solid foreign objects Ø 2.5 mm.
4	Protected against access to hazardous parts with a wire. Protected against solid foreign objects Ø 1 mm.
5	Protected against access to hazardous parts with a wire. Dust-protected. Intrusion of dust is not totally prevented, but dust shall not penetrate in a quantity to interfere with satisfactory operation of the device or to impair safety.
6	Protected against access to hazardous parts with a wire. Dust-tight. No intrusion of dust.
2. Number: water* protection	Definition
0	Non-protected
1	Protected against water drops
2	Protected against water drops when enclosure tilted up to 15°.
3	Protected against spraying water. Water sprayed at an angle up to 60° on either side of the vertical shall have no harmful effects.
4	Protected against splashing water. Water splashed against the disclosure from any direction shall have no harmful effects
5	Protected against water jets
6	Protected against powerful water jets
7	Protected against the effects of temporary immersion in water. Intrusion of water in quantities causing harmful effects shall not be possible when the enclosure is temporarily immersed in water for 30 min. in 1 m depth.

*) These protection classes define only protection against water.

Chemical Resistance

The Resistance relates to the Housing of the IP67 modules and the used metal parts. In the table below you will find some typical resistance.

Character	Resistance
Steam	at temperatures >100°C: not resistant
Sodium base liquor (ph-Value > 12)	at room temperature: resistant > 40°C: not resistant
Acetic acid	not resistant
Argon (technical clean)	resistant

Key

- resistant: Lifetime several months
- non inherently resistant: Lifetime several weeks
- not resistant: Lifetime several hours resp. early decomposition

7.2 Accessories

Mounting

Ordering information	Description	Link
ZS5300-0011	Mounting rail	Website

Labeling material, protective caps

Ordering information	Description
ZS5000-0010	Protective cap for M8 sockets, IP67 (50 pieces)
ZS5100-0000	Inscription labels, unprinted, 4 strips of 10
ZS5000-xxxx	Printed inscription labels on enquiry

Cables

A complete overview of pre-assembled cables for fieldbus components can be found [here](#).

Ordering information	Description	Link
ZK1090-3xxx-xxxx	EtherCAT cable M8, green	Website
ZK1093-3xxx-xxxx	EtherCAT cable M8, yellow	Website
ZK2000-3xxx-xxxx	Sensor cable M8, 4-pin	Website
ZK2020-3xxx-xxxx	Power cable M8, 4-pin	Website

Tools

Ordering information	Description
ZB8801-0000	Torque wrench for plugs, 0.4...1.0 Nm
ZB8801-0001	Torque cable key for M8 / wrench size 9 for ZB8801-0000



Further accessories

Further accessories can be found in the price list for fieldbus components from Beckhoff and online at <https://www.beckhoff.com>.

7.3 Notices on analog specifications

Beckhoff I/O devices (terminals, box modules, modules) with analog inputs and outputs are characterized by a number of technical characteristic data; refer to the technical data in the respective documents.

Some explanations are given below for the correct interpretation of these characteristic data.

Unless otherwise stated, the explanations apply accordingly to input and output signals.

7.3.1 Full scale value (FSV), output end value

An I/O device with analog input measures over a nominal measuring range, which is limited by an upper and a lower limit (start value and end value), which can usually already be taken from the device designation. The range between both limits is called measuring span and corresponds to the formula (end value - start value). Analogous to pointing devices this is the measuring scale (see IEC 61131) or also the dynamic range.

For analog I/O devices from Beckhoff, the full scale value (FSV) of the respective product (also: reference value) is selected as the largest limit of the nominal measuring range and is given a positive sign. This applies to both symmetrical and asymmetrical measuring spans.

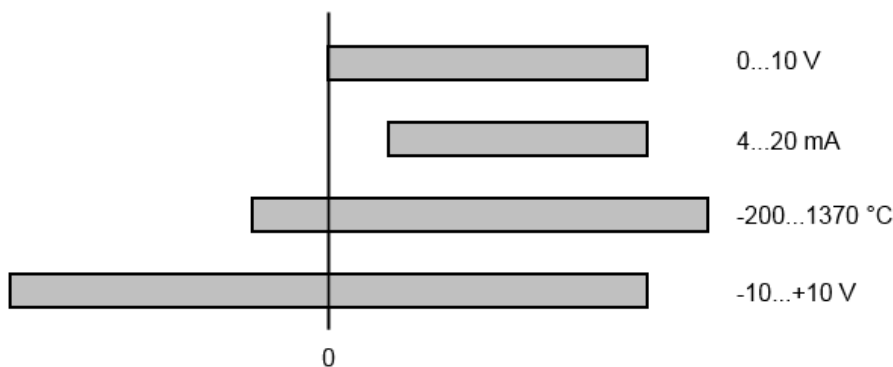

Fig. 45: Full scale value, measuring span

For the above **examples** this means:

- Measuring range 0...10 V: asymmetric unipolar, FSV = 10 V, measuring span = 10 V
- Measuring range 4...20 mA: asymmetric unipolar, FSV = 20 mA, measuring span = 16 mA
- Measuring range -200...1370 °C: asymmetric bipolar, FSV = 1370 °C, measuring span = 1570 °C
- Measuring range -10...+10 V: symmetric bipolar, FSV = 10 V, measuring span = 20 V

Depending on the functionality, an analog input channel may have a technical measuring range that exceeds the nominal measuring range, e.g. to gain more diagnostic information about the signal.

The case-by-case information in the device documentation on the behavior outside the nominal measuring range (measurement uncertainty, display value) must be observed.

The above thoughts are correspondingly applicable to analog output devices:

- The full scale value (FSV) becomes the output end value
- Here, too, there can be a (larger) technical output range in addition to the nominal output range

7.3.2 Measurement error/measurement deviation/measurement uncertainty, output uncertainty

● Analog output

i The following information also applies analogously to the output end value of analog output devices.

The relative measuring error as a specification value of a Beckhoff analog device is specified in % of the nominal FSV (output end value) and calculated as the quotient of the numerically largest probable deviation from the true measured value (output value) with respect to the FSV (output end value):

$$\text{Measuring error} = \frac{\left| \text{max. deviation} \right|}{\text{full scale value}}$$

It should be noted here that the "true measured value" cannot be determined with infinite accuracy either, but can only be determined via reference devices with a higher expenditure of technology and measuring time and thus a significantly lower measurement uncertainty.

The value therefore describes the result window in which the measured value determined by the device under consideration (Beckhoff analog device) lies with a very high probability in relation to the "true value". Thus, colloquially, this is a "typical" value (typ.); this expresses that the vast statistical majority of values will be within the specification window, but in rare cases there may/will be deviations outside the window.

For this reason, the term "measurement uncertainty" has become established for this window, since "error" is now used to refer to known disturbance effects that can generally be systematically eliminated.

The uncertainty of measurement must always be considered in relation to potential environmental influences:

- invariable electrical channel properties such as temperature sensitivity,
- variable settings of the channel (noise via filters, sampling rate, ...).

Measurement uncertainty specifications without further operational limitation (also called "service error limit") can be assumed as a value "over everything": entire permissible operating temperature range, default setting, etc.

The window is always to be understood as a positive/negative span with "±", even if occasionally indicated as a "half" window without "±".

The maximum deviation can also be specified directly.

Example: measuring range 0...10 V (FSV = 10 V) and measurement uncertainty $< \pm 0.3\%_{\text{FSV}}$ → the expected maximum usual deviation is ± 30 mV in the permissible operating temperature range.

● Lower measurement uncertainty possible

I If this specification also includes the temperature drift, a significantly lower measuring error can usually be assumed in case of a constant ambient temperature of the device and thermal stabilization after a user calibration.

7.3.3 Temperature coefficient tK [ppm/K]

An electronic circuit is usually temperature dependent to a greater or lesser degree. In analog measurement technology this means that when a measured value is determined by means of an electronic circuit, its deviation from the "true" value is reproducibly dependent on the ambient/operating temperature.

A manufacturer can alleviate this by using components of a higher quality or by software means.

The temperature coefficient, when indicated, specified by Beckhoff allows the user to calculate the expected measuring error outside the basic accuracy. The basic accuracy is usually specified for 23 °C ambient temperature, in special cases also at other temperature.

Due to the extensive uncertainty considerations that are incorporated in the determination of the basic accuracy, Beckhoff recommends a quadratic summation.

Example: Let the basic accuracy be $\pm 0.01\%$ typ. (full scale value), $tK = 20$ ppm/K typ at 23 °C.; the accuracy A35 at 35 °C is wanted, hence $\Delta T = 12$ K:

$$G35 = \sqrt{(0.01\%)^2 + (12K \cdot 20 \frac{\text{ppm}}{\text{K}})^2} = 0.026\% \text{ full scale value, typ.}$$

Remarks: ppm $\triangleq 10^{-6}$ % $\triangleq 10^{-2}$

7.3.4 Long-term use

Analog devices (inputs, outputs) are subject to constant environmental influences during operation (temperature, temperature change, shock/vibration, irradiation, etc.) This can affect the function, in particular the analog accuracy (also: measurement or output uncertainty).

As industrial products, Beckhoff analog devices are designed for 24h/7d continuous operation.

The devices show that they generally comply with the accuracy specification, even in long-term use. However, as is usual for technical devices, an unlimited functional assurance (also applies to accuracy) cannot be given.

Beckhoff recommends checking the usability in relation to the application target within the scope of normal system maintenance, e.g. every 12-24 months.

7.3.5 Ground reference: single-ended/differential typification

For analog inputs Beckhoff makes a basic distinction between two types: *single-ended* (SE) and *differential* (DIFF), referring to the difference in electrical connection with regard to the potential difference.

The diagram shows two-channel versions of an SE module and a DIFF module as examples for all multi-channel versions.

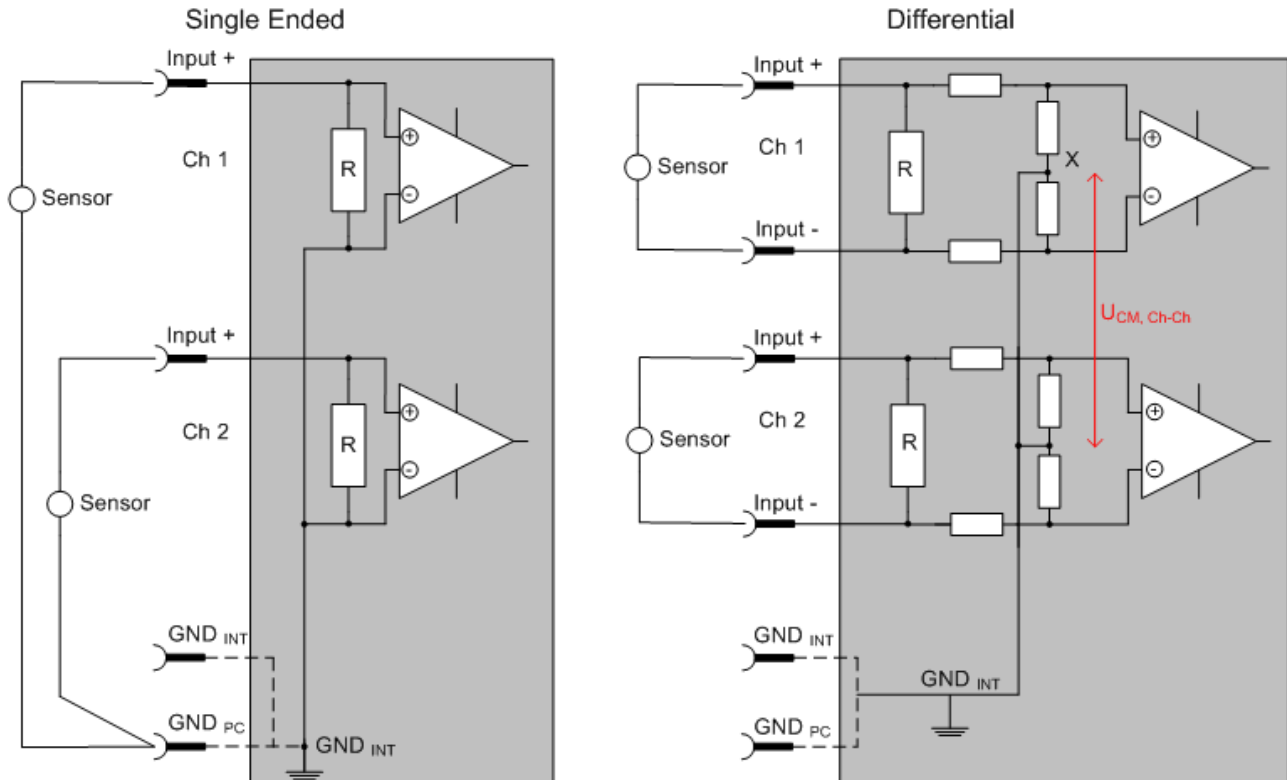

Fig. 46: SE and DIFF module as 2-channel version

Note: Dashed lines indicate that the respective connection may not necessarily be present in each SE or DIFF module. Electrical isolated channels are operating as differential type in general, hence there is no direct relation (voltaic) to ground within the module established at all. Indeed, specified information to recommended and maximum voltage levels have to be taken into account.

The basic rule:

- Analog measurements always take the form of voltage measurements between two potential points. For voltage measurements a large R is used, in order to ensure a high impedance. For current measurements a small R is used as shunt. If the purpose is resistance measurement, corresponding considerations are applied.

- Beckhoff generally refers to these two points as input+/signal potential and input-/reference potential.
- For measurements between two potential points two potentials have to be supplied.
- Regarding the terms “single-wire connection” or “three-wire connection”, please note the following for pure analog measurements: three- or four-wire connections can be used for sensor supply, but are not involved in the actual analog measurement, which always takes place between two potentials/wires.
In particular this also applies to SE, even though the term suggest that only one wire is required.
- The term “electrical isolation” should be clarified in advance.
Beckhoff IO modules feature 1..8 or more analog channels; with regard to the channel connection a distinction is made in terms of:
 - how the channels WITHIN a module relate to each other, or
 - how the channels of SEVERAL modules relate to each other.

The property of electrical isolation indicates whether the channels are directly connected to each other.

 - Beckhoff terminals/ box modules (and related product groups) always feature electrical isolation between the field/analog side and the bus/EtherCAT side. In other words, if two analog terminals/ box modules are not connected via the power contacts (cable), the modules are effectively electrically isolated.
 - If channels within a module are electrically isolated, or if a single-channel module has no power contacts, the channels are effectively always differential. See also explanatory notes below.
Differential channels are not necessarily electrically isolated.
- Analog measuring channels are subject to technical limits, both in terms of the recommended operating range (continuous operation) and the destruction limit. Please refer to the respective terminal/ box documentation for further details.

Explanation

- **Differential (DIFF)**
 - Differential measurement is the most flexible concept. The user can freely choose both connection points, input+/signal potential and input-/reference potential, within the framework of the technical specification.
 - A differential channel can also be operated as SE, if the reference potential of several sensors is linked. This interconnection may take place via the system GND.
 - Since a differential channel is configured symmetrically internally (cf. Fig. SE and DIFF module as 2-channel variant), there will be a mid-potential (X) between the two supplied potentials that is the same as the internal ground/reference ground for this channel. If several DIFF channels are used in a module without electrical isolation, the technical property V_{CM} (common-mode voltage) indicates the degree to which the mean voltage of the channels may differ.
 - The internal reference ground may be accessible as connection point at the terminal/ box, in order to stabilize a defined GND potential in the terminal/ box. In this case it is particularly important to pay attention to the quality of this potential (noiselessness, voltage stability). At this GND point a wire may be connected to make sure that $V_{CM,max}$ is not exceeded in the differential sensor cable. If differential channels are not electrically isolated, usually only one $V_{CM,max}$ is permitted. If the channels are electrically isolated this limit should not apply, and the channels voltages may differ up to the specified separation limit.
 - Differential measurement in combination with correct sensor wiring has the special advantage that any interference affecting the sensor cable (ideally the feed and return line are arranged side by side, so that interference signals have the same effect on both wires) has very little effect on the measurement, since the potential of both lines varies jointly (hence the term common mode). In simple terms: Common-mode interference has the same effect on both wires in terms of amplitude and phasing.
 - Nevertheless, the suppression of common-mode interference within a channel or between channels is subject to technical limits, which are specified in the technical data.
 - Further helpfully information on this topic can be found on the documentation page *Configuration of 0/4..20 mA differential inputs* (see documentation for the EL30xx terminals, for example).

- **Single-ended (SE)**

- If the analog circuit is designed as SE, the input/reference wire is internally fixed to a certain potential that cannot be changed. This potential must be accessible from outside on at least one point for connecting the reference potential, e.g. via the power contacts (cable).
- In other words, in situations with several channels SE offers users the option to avoid returning at least one of the two sensor cables to the terminal/ box (in contrast to DIFF). Instead, the reference wire can be consolidated at the sensors, e.g. in the system GND.
- A disadvantage of this approach is that the separate feed and return line can result in voltage/ current variations, which a SE channel may no longer be able to handle. See common-mode interference. A V_{CM} effect cannot occur, since the module channels are internally always 'hard-wired' through the input/reference potential.

Typification of the 2/3/4-wire connection of current sensors

Current transducers/sensors/field devices (referred to in the following simply as 'sensor') with the industrial 0/4-20 mA interface typically have internal transformation electronics for the physical measured variable (temperature, current, etc.) at the current control output. These internal electronics must be supplied with energy (voltage, current). The type of cable for this supply thus separates the sensors into *self-supplied* or *externally supplied* sensors:

Self-supplied sensors

- The sensor draws the energy for its own operation via the sensor/signal cable + and -. So that enough energy is always available for the sensor's own operation and open-circuit detection is possible, a lower limit of 4 mA has been specified for the 4-20 mA interface, i.e. the sensor allows a minimum current of 4 mA and a maximum current of 20 mA to pass.
- 2-wire connection see Fig. *2-wire connection*, cf. IEC60381-1
- Such current transducers generally represent a current sink and thus like to sit between + and - as a 'variable load'. Refer also to the sensor manufacturer's information.

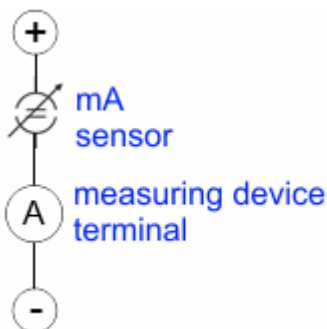

Fig. 47: 2-wire connection

Therefore, they are to be connected according to the Beckhoff terminology as follows:

preferably to '**single-ended**' inputs if the +Supply connections of the terminal/ box are also to be used - connect to +Supply and Signal

they can, however, also be connected to '**differential**' inputs, if the termination to GND is then manufactured on the application side - to be connected with the right polarity to +Signal and -Signal. It is important to refer to the information page *Configuration of 0/4..20 mA differential inputs* (see documentation for the EL30xx terminals, for example)!

Externally supplied sensors

- 3- and 4-wire connection see Fig. *Connection of externally supplied sensors*, cf. IEC60381-1
- the sensor draws the energy/operating voltage for its own operation from two supply cables of its own. One or two further sensor cables are used for the signal transmission of the current loop:
 - 1 sensor cable: according to the Beckhoff terminology such sensors are to be connected to '**single-ended**' inputs in 3 cables with +/-Signal lines and if necessary, FE/shield

- 2 sensor cables: for sensors with 4-wire connection based on +supply/-supply/+signal/-signal, check whether +signal can be connected to +supply or -signal to -supply.
 - Yes: then you can connect accordingly to a Beckhoff **'single-ended'** input.
 - No: the Beckhoff **'differential'** input for +Signal and -Signal is to be selected; +Supply and -Supply are to be connected via additional cables.
 It is important to refer to the information page *Configuration of 0/4..20 mA differential inputs* (see documentation for the EL30xx terminals, for example)!

Note: expert organizations such as NAMUR demand a usable measuring range <4 mA/>20 mA for error detection and adjustment, see also NAMUR NE043.

The Beckhoff device documentation must be consulted in order to see whether the respective device supports such an extended signal range.

Usually there is an internal diode existing within unipolar terminals/ box modules (and related product groups), in this case the polarity/direction of current have to be observed.

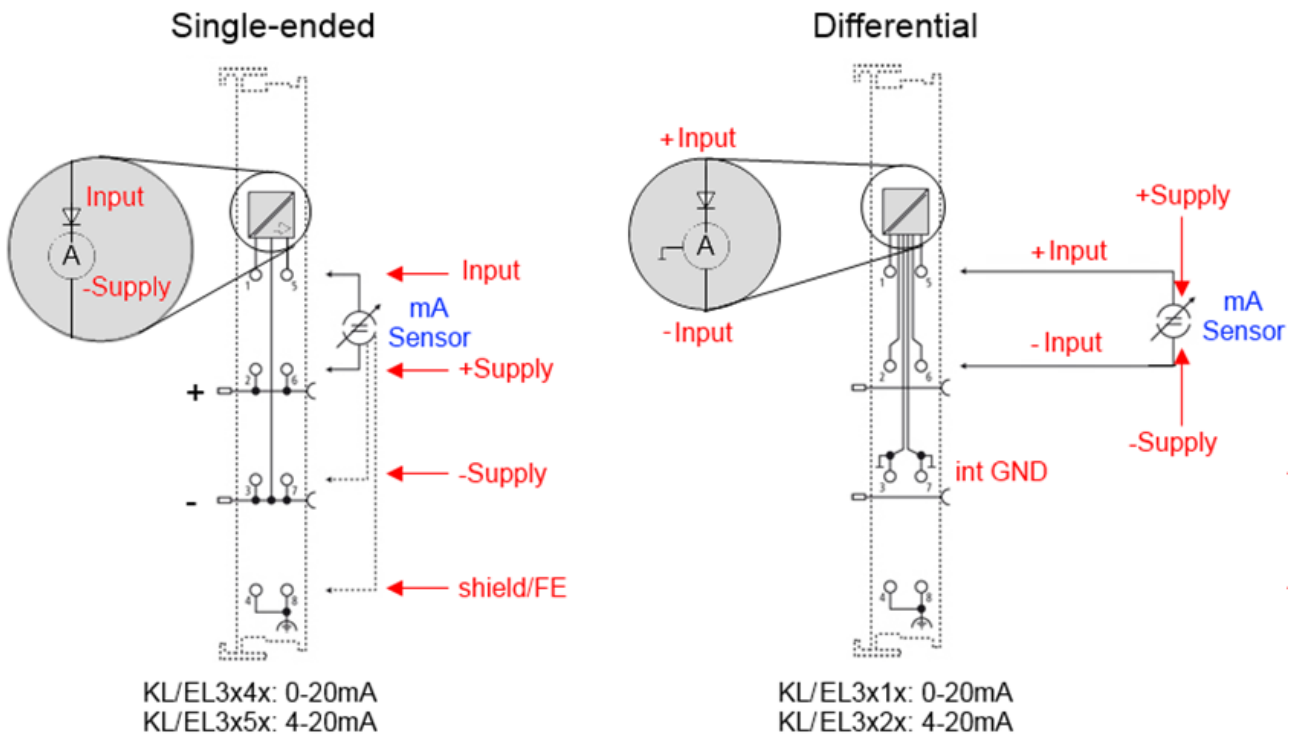

Fig. 48: Connection of externally supplied sensors

Classification of Beckhoff Terminals/ Box modules - Beckhoff 0/4-20 mA Terminals/ Box modules (and related product groups) are available as **differential** and **single-ended**:

Single-ended

EL3x4x: 0-20 mA, EL3x5x: 4-20 mA, same as KL and related product groups
 Preferred current direction because of internal diode
 Designed for the connection of externally-supplied sensors with a 3/4-wire connection.
 Designed for the connection of self-supplied sensors with a 2-wire connection

Differential

EL3x1x: 0-20 mA, EL3x2x: 4-20 mA, same as KL and related product groups
 Preferred current direction because of internal diode
 The terminal/box is a passive differential current measuring device; passive means that the sensor is not supplied with power.

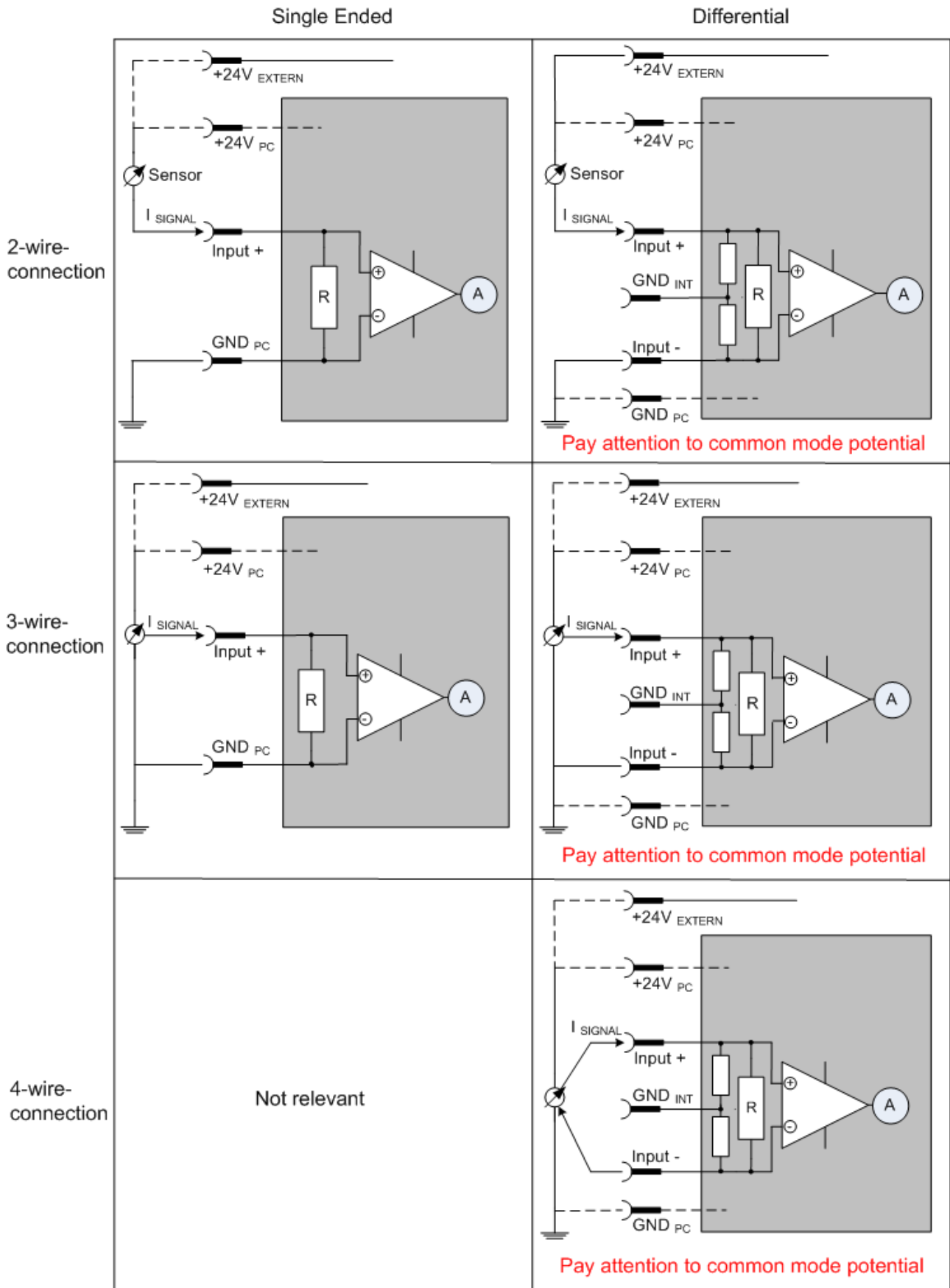

Fig. 49: 2-, 3- and 4-wire connection at single-ended and differential inputs

7.3.6 Common-mode voltage and reference ground (based on differential inputs)

Common-mode voltage (V_{cm}) is defined as the average value of the voltages of the individual connections/ inputs and is measured/specified against reference ground.

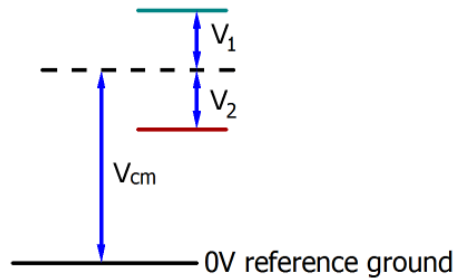

Fig. 50: Common-mode voltage (V_{cm})

The definition of the reference ground is important for the definition of the permitted common-mode voltage range and for measurement of the common-mode rejection ratio (CMRR) for differential inputs.

The reference ground is also the potential against which the input resistance and the input impedance for single-ended inputs or the common-mode resistance and the common-mode impedance for differential inputs is measured.

The reference ground is usually accessible at or near the terminal/ box, e.g. at the terminal contacts, power contacts (cable) or a mounting rail. Please refer to the documentation regarding positioning. The reference ground should be specified for the device under consideration.

For multi-channel terminals/ box modules with resistive (= direct, ohmic, galvanic) or capacitive connection between the channels, the reference ground should preferably be the symmetry point of all channels, taking into account the connection resistances.

Reference ground samples for Beckhoff IO devices:

1. Internal AGND fed out: EL3102/EL3112, resistive connection between the channels
2. 0V power contact: EL3104/EL3114, resistive connection between the channels and AGND; AGND connected to 0V power contact with low-resistance
3. Earth or SGND (shield GND):
 - EL3174-0002: Channels have no resistive connection between each other, although they are capacitively coupled to SGND via leakage capacitors
 - EL3314: No internal ground fed out to the terminal points, although capacitive coupling to SGND

7.3.7 Dielectric strength

A distinction should be made between:

- Dielectric strength (destruction limit): Exceedance can result in irreversible changes to the electronics
 - Against a specified reference ground
 - Differential
- Recommended operating voltage range: If the range is exceeded, it can no longer be assumed that the system operates as specified
 - Against a specified reference ground
 - Differential

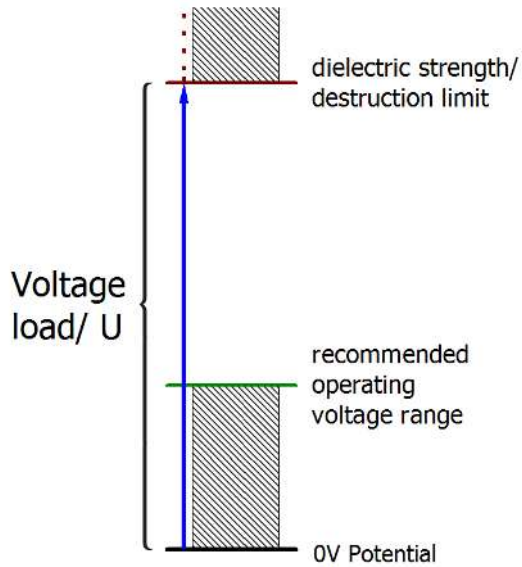

Fig. 51: Recommended operating voltage range

The device documentation may contain particular specifications and timings, taking into account:

- Self-heating
- Rated voltage
- Insulating strength
- Edge steepness of the applied voltage or holding periods
- Normative environment (e.g. PELV)

7.3.8 Temporal aspects of analog/digital or digital/analog conversion

● Analog output

i The following information applies analogously to analog signal output via DAC (digital-to-analog converter).

The conversion of the constant electrical input signal to a value-discrete digital and machine-readable form takes place in the analog Beckhoff EL/KL/EP input modules with ADC (analog digital converter). Although different ADC technologies are common, from the user's point of view they all have one common feature: after the end of the conversion, a certain digital value is available for further processing in the controller. This digital value, the so-called analog process data, has a fixed temporal relationship with the “original parameter”, i.e. the electrical input value. Therefore, corresponding temporal characteristic data can be determined and specified for Beckhoff analogue input devices.

This process involves several functional components, which act more or less strongly in every AI (analog input) module:

- the electrical input circuit
- the analog/digital conversion
- the digital further processing
- the final provision of the process and diagnostic data for collection at the fieldbus (EtherCAT, K-bus, etc.)

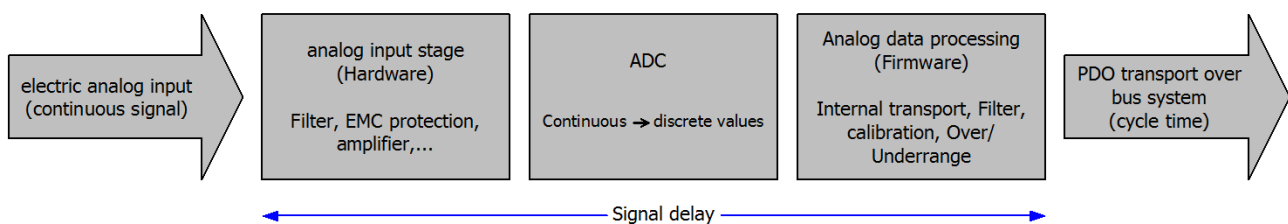

Fig. 52: Signal processing analog input

Two aspects are crucial from a user perspective:

- “How often do I receive new values?”, i.e. a sampling rate in terms of speed with regard to the device/channel
- What delay does the (whole) AD conversion of the device/channel cause?
So hardware and firmware parts in toto. For technological reasons, the signal characteristics must be considered to determine this specification: depending on the signal frequency, there may be different propagation times through the system.

This is the “external” view of the “Beckhoff AI channel” system – internally the signal delay in particular is composed of different components: hardware, amplifier, conversion itself, data transport and processing. Internally a higher sampling rate may be used (e.g. in the deltaSigma converters) than is offered “externally” from the user perspective. From a user perspective of the “Beckhoff AI channel” component this is usually irrelevant or is specified accordingly, if it is relevant for the function.

For Beckhoff AI devices the following specification parameters for the AI channel are available for the user from a temporal perspective:

1. Minimum conversion time [ms, µs]

This is the reciprocal value of the maximum **sampling rate** [Sps, samples per second]:

Specifies how often the analog channel provides a newly detected process data value for collection by the fieldbus. Whether the fieldbus (EtherCAT, K-bus) fetches the value with the same speed (i.e. synchronous), or more quickly (if the AI channel operates in slow FreeRun mode) or more slowly (e.g. with oversampling), is then a question of the fieldbus setting and which modes the AI device supports.

For EtherCAT devices the so-called toggle bit indicates (by toggling) for the diagnostic PDOs when a newly determined analog value is available.

Accordingly, a maximum conversion time, i.e. a smallest sampling rate supported by the AI device, can be specified.

Corresponds to IEC 61131-2 Chap. 7.10.2 2, "Sampling repeat time"

2. Typical signal delay

Corresponds to IEC 61131-2, Chapter 7.10.2 1, "Sampling duration". From this perspective it includes all internal hardware and firmware components, but not "external" delay components from the fieldbus or the controller (TwinCAT).

This delay is particularly relevant for absolute time considerations, if AI channels also provide a timestamp that corresponds to the amplitude value – which can be assumed to match the physically prevailing amplitude value at the time.

Due to the frequency-dependent runtime of a signal, a dedicated value can only be specified for a given signal. The value also depends on possibly changing filter settings of the channel.

A typical characterization in the device documentation can be:

2.1 Signal delay (step response)

Keyword settling time:

The square wave signal can be generated externally with a frequency generator (note impedance!).

The 90% limit is used as detection threshold.

The signal delay [ms, μ s] is then the time interval between the (ideal) electrical square wave signal and the time when the analog process value has reached the 90% amplitude.

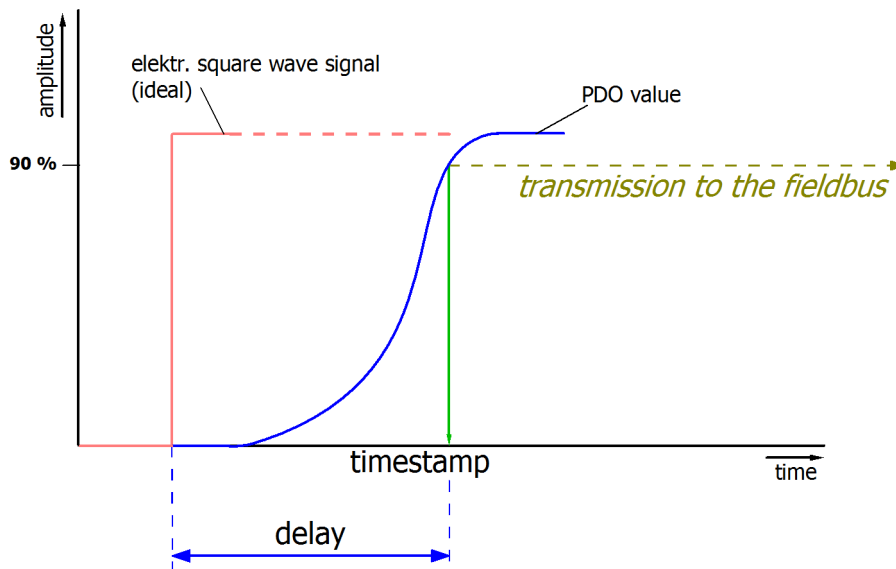

Fig. 53: Diagram Signal delay (step response)

2.2 Signal delay (linear)

Keyword group delay:

Describes the delay of a frequency-constant signal

Test signal can be generated externally with a frequency generator, e.g. as sawtooth or sine. Reference would then be a simultaneous square wave signal.

The signal delay [ms, μ s] is then the time interval between the applied electrical signal of a certain amplitude and the moment when the analog process value reaches the same value.

For this purpose, the test frequency must be selected in a reasonable range; this can be, for example, 1/20 of the maximum sampling rate.

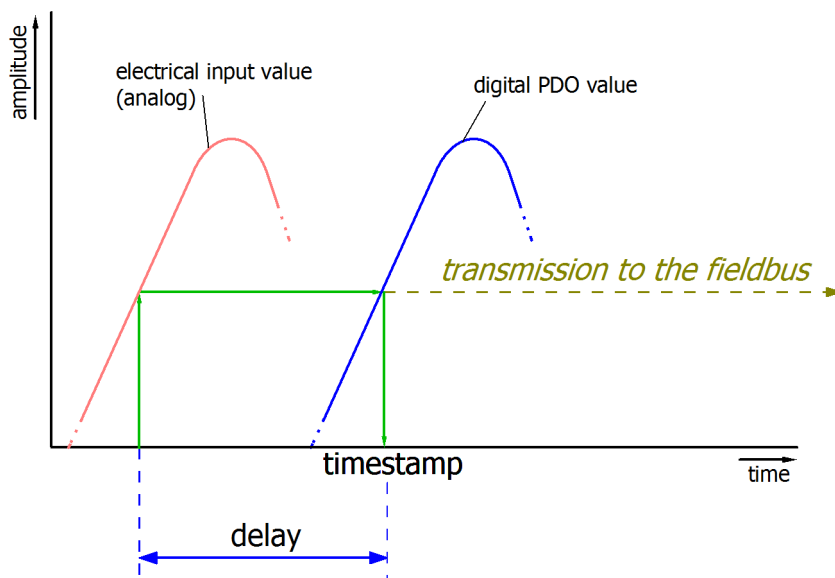

Fig. 54: Diagram Signal delay (linear)

3. Additional information

Additional information may be provided in the specification, e.g.

- actual sampling rate of the ADC (if different from the channel sampling rate)
- time correction values for runtimes with different filter settings
- etc.

7.3.9 Explanation of the term GND/Ground

I/O devices always have a reference potential somewhere. After all, the working voltage is only created by two points having different potentials – one of these points is then called the reference potential.

In the Beckhoff I/O area and in particular with the analog products, various reference potentials are used and named. These are defined, named and explained here.

Note: for historical reasons, different names are used with various Beckhoff I/O products. The following explanations place them on a uniform foundation.

SGND

- Also called: FE, Functional Earth, Shield GND, Shield.
- Use: Dissipation of interference and radiation, predominantly currentless.
- Symbol: .
- Notes and recommendations on SGND/FE can be found in the separate chapter Notes regarding analog equipment - shielding and earth.
- SGND usually ends at the structural earth star point.
- In order to be usable for its intended purpose, SGND itself should be a low noise/noise-free "clean" current and voltage sink.

PE

- Also called: Protective Earth.
- Use: Protective measure to prevent the occurrence of hazardous touch voltages by dissipating these touch voltages and then tripping upstream protective devices. If installed correctly, the PE conductor is currentless, but according to specification it must be capable of conducting for the protection case.

- Symbol: .
- PE usually ends at the structural earth star point.
- For specifications and notes on PE, please refer to the relevant rules.

PGND, AGND

- Use: Reference ground or return line of analog or digital signals.
- Depending on use, nominally currentless as reference potential or conducting as return line.
- In the analog area, the so-called standard signals can be 0...10 V and 4...20 mA, measuring bridge signals and thermocouples can be in the range of a few mV and resistance measurement in any Ohm range, and voltages can be from μV to a few thousand Volts.
- In the digital area they can be, for example, 0/24 V, -5/+5 V etc.
- Symbols:

preferred: .

hardly used any more, but actually means earth potential: .

- There may be several PGND/AGND networks in a system that are electrically isolated from one another.
- If a device has several AGNDs, due to isolation by channel, these can be numbered: AGND1, AGND2, ...
- PGND
 - also called: GND_{PC} , 0 V, power contact 0 V, GND.
 - Version: PGND is a structural description of the "negative" power contact rail of the Bus Terminal system.

- Can be connected to the device electronics, for example for supplying power to the device or as a signal feedback (see chapter [Ground reference: single-ended/differential typification \[▶ 84\]](#)). Refer to the respective device documentation.
- Example: PGND is not connected to the device electronics:

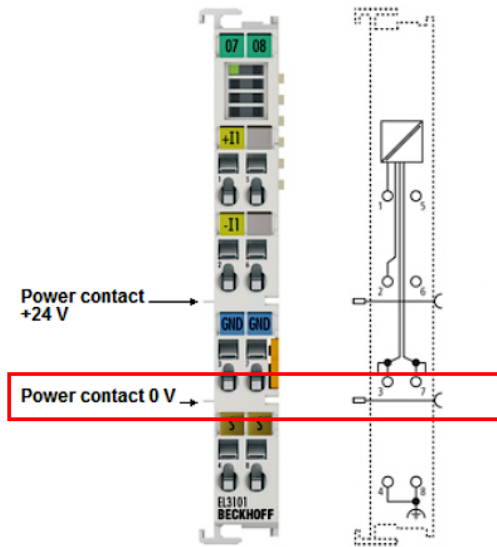

• AGND

- Also called: GND_{int} , GND , analog ground, GND_{analog} .
- AGND electrically designates the device's analog reference ground.
- AGND can, for example, be internally connected to PGND or to a connection point so that it can be connected externally to a desired potential. Electrical restrictions according to the device documentation must be observed, e.g. common mode limits.
- AGND is usually a currentless reference potential. The action of interference on AGND must be avoided.
- Example: AGND is fed out on the device plug:

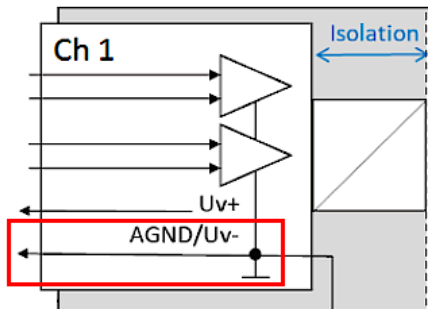

7.3.10 Sampling type: Simultaneous vs. multiplexed

Analog inputs and outputs in Beckhoff devices can operate in two different ways in terms of time: "simultaneous sampling" or "multiplex sampling". This so-called sampling type has a decisive influence on the performance of such a device and must be taken into consideration when selecting a product, at least when it comes to very complex timing control tasks. Whether an analog device operates simultaneously or multiplexed can be taken from the respective device documentation.

This question is relevant for control tasks as well as for measurement tasks (DataRecording), if the timing of the analog value acquisition is sensitive.

Note: The terms "simultaneous" and "multiplex" have been used for a long time and in many contexts, so they have different meanings depending on the historical background and the subject area. In this chapter and in relation to I/O, the terms are used as Beckhoff understands them as an I/O manufacturer for the benefit of the user:

- If a test signal is applied electrically to all channels of a multi-channel device at the same time and the measurements are evaluated in software, e.g. in TwinCAT Scope, and if no significant offset/delay can be observed between the channels, then it is a **simultaneously sampling device** ¹⁾
- If an offset can be seen, it is a **multiplex sampling device**
- The easiest **test** to perform is with a square wave signal because an offset can then be easily observed. However, the rare special case could occur (especially if the test signal is generated from an EL2xxx/EL4xxx from the same IO line) that the square wave signal runs synchronously to the EtherCAT for several minutes and then no offset can be seen.

Absolutely safe is a test with a sinusoidal signal, but then it must be considered that measurement deviations (related to the amplitude) of the channels in the device are also represented as time offset!

Ideally, one should concentrate on the zero crossing.

- 1-channel devices are considered as simultaneous sampling by definition.

Explanation with the example "analog input": if a continuous analog signal is to be digitized and thus fed to the further programmatic processing, it is digitized by a so-called ADC (AnalogDigitalConverter), e.g. with 16 bit resolution:



Fig. 55: Schematic representation of sampling with ADC converter

This represents an analog input channel that is functional in itself. It samples (measures) as often as desired, e.g. 1,000 times per second, and thus sends 1,000 measured values equidistant in time (= at equal time intervals) for further processing.

Often several channels are combined in one device, in this case the question arises about the sampling type: simultaneous or multiplex.

¹⁾ For experts: such a device could also be equipped with a multiplexing ADC, which works with sample-and-hold on all channels. Then technically multiplex is built in, but from the outside the device works simultaneously, because all channels are electrically read in at the same time.

Simultaneous

As in the 1-channel example, each channel can have its own ADC, shown here for 4 channels:

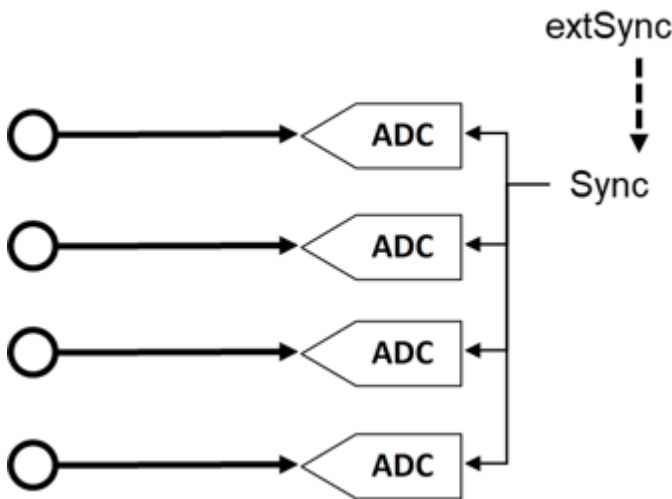

Fig. 56: Schematic representation simultaneous sampling with 4 ADC converters

These ADCs rarely run free in time and sample independently but are normal triggered in some way (the measurement is triggered) to achieve the most desired effect that the n channels sample simultaneously. This gives the analog input device the property that all (4) measurements are obtained at the same time. This gives a temporally consistent view of the machine situation and makes measurement evaluations in the controller very easy. If the ADC are triggered simultaneously by the sync signal, this is called simultaneous sampling.

A special added value arises when such devices are synchronized externally, e.g. via EtherCAT DistributedClocks, and then all analog channels of all devices of a plant operate simultaneously: either really simultaneously without offset among each other or with the same frequency but with constant, known and thus compensatable offset among each other.

As shown above, this requires extensive electronics with multiple identical structures. For this reason, parallel analog devices are usually always simultaneously sampling. Free-running or non-triggered, multiple ADCs are conceivable (and can then no longer be called "simultaneous"), but are rather uncommon.

Multiplex

Simultaneous sampling is often not required for simple automation tasks. This may be because the simplest analog electronics are to be used for cost reasons, or the control cycle time is relatively slow compared to the conversion time in the ADC. Then the advantages of the multiplex concept can be used: Instead of 4 ADC only one ADC is installed, for this a channel switch (from the device manufacturer) must be installed, which switches through the 4 input channels to the ADC quickly one after the other in the μ s range. The switching process is performed by the device itself and is usually not accessible from the outside.

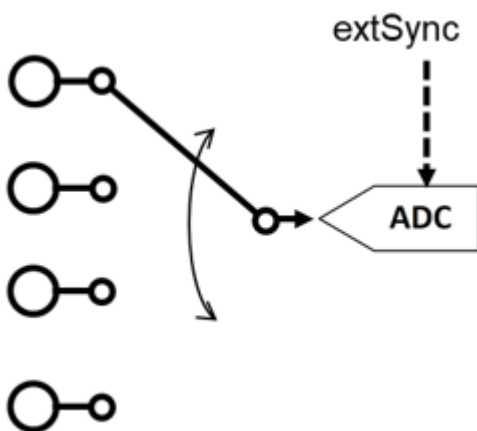

Fig. 57: Schematic representation of multiplex sampling with an ADC converter

This is therefore a time multiplex. As a rule the ADC samples equally clocked, the time intervals of the channels are therefore equal, whereby the start of channel 1 is usually done by the communication cycle (EtherCAT) or DistributedClocks. For further details please refer to the device documentation.

Advantage: cheaper electronics compared to simultaneous setup.

Disadvantage: the measured values are no longer acquired simultaneously, but one after the other.

Both circuits have their technical and economic justification, for time demanding automation tasks simultaneous circuits should always be chosen, because with them it is easier to keep the temporal overview.

For analog outputs the same explanations apply, they can also be equipped with multiple simultaneous DACs or output a multiplexed DAC to several outputs.

7.4 Version identification of EtherCAT devices

7.4.1 General notes on marking

Designation

A Beckhoff EtherCAT device has a 14-digit designation, made up of

- family key
- type
- version
- revision

Example	Family	Type	Version	Revision
EL3314-0000-0016	EL terminal (12 mm, non-pluggable connection level)	3314 (4-channel thermocouple terminal)	0000 (basic type)	0016
ES3602-0010-0017	ES terminal (12 mm, pluggable connection level)	3602 (2-channel voltage measurement)	0010 (high-precision version)	0017
CU2008-0000-0000	CU device	2008 (8-port fast ethernet switch)	0000 (basic type)	0000

Notes

- The elements mentioned above result in the **technical designation**. EL3314-0000-0016 is used in the example below.
- EL3314-0000 is the order identifier, in the case of “-0000” usually abbreviated to EL3314. “-0016” is the EtherCAT revision.
- The **order identifier** is made up of
 - family key (EL, EP, CU, ES, KL, CX, etc.)
 - type (3314)
 - version (-0000)
- The **revision** -0016 shows the technical progress, such as the extension of features with regard to the EtherCAT communication, and is managed by Beckhoff.
In principle, a device with a higher revision can replace a device with a lower revision, unless specified otherwise, e.g. in the documentation.
Associated and synonymous with each revision there is usually a description (ESI, EtherCAT Slave Information) in the form of an XML file, which is available for download from the Beckhoff web site.
From 2014/01 the revision is shown on the outside of the IP20 terminals, see Fig. “EL5021 EL terminal, standard IP20 IO device with batch number and revision ID (since 2014/01)”.
- The type, version and revision are read as decimal numbers, even if they are technically saved in hexadecimal.

7.4.2 Version identification of EP/EPI/EPP/ER/ERI boxes

The serial number/ data code for Beckhoff IO devices is usually the 8-digit number printed on the device or on a sticker. The serial number indicates the configuration in delivery state and therefore refers to a whole production batch, without distinguishing the individual modules of a batch.

Structure of the serial number: **KK YY FF HH**

KK - week of production (CW, calendar week)

YY - year of production

FF - firmware version

HH - hardware version

Example with serial number 12 06 3A 02:

12 - production week 12

06 - production year 2006

3A - firmware version 3A

02 - hardware version 02

Exceptions can occur in the **IP67 area**, where the following syntax can be used (see respective device documentation):

Syntax: D ww yy x y z u

D - prefix designation

ww - calendar week

yy - year

x - firmware version of the bus PCB

y - hardware version of the bus PCB

z - firmware version of the I/O PCB

u - hardware version of the I/O PCB

Example: D.22081501 calendar week 22 of the year 2008 firmware version of bus PCB: 1 hardware version of bus PCB: 5 firmware version of I/O PCB: 0 (no firmware necessary for this PCB) hardware version of I/O PCB: 1

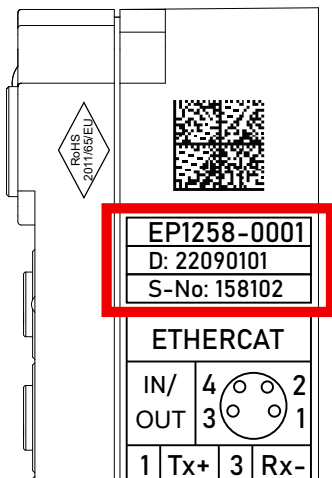

Fig. 58: EP1258-00001 IP67 EtherCAT Box with batch number/DateCode 22090101 and unique serial number 158102

7.4.3 Beckhoff Identification Code (BIC)

The Beckhoff Identification Code (BIC) is increasingly being applied to Beckhoff products to uniquely identify the product. The BIC is represented as a Data Matrix Code (DMC, code scheme ECC200), the content is based on the ANSI standard MH10.8.2-2016.

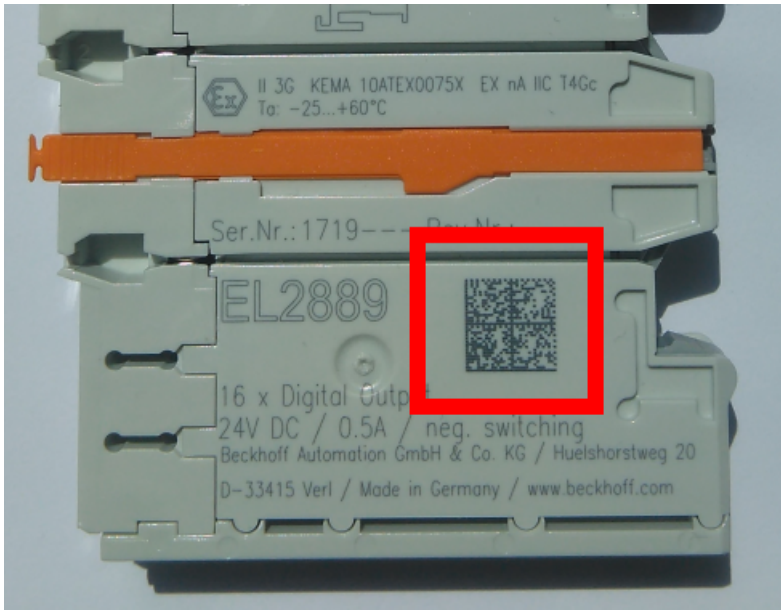

Fig. 59: BIC as data matrix code (DMC, code scheme ECC200)

The BIC will be introduced step by step across all product groups.

Depending on the product, it can be found in the following places:

- on the packaging unit
- directly on the product (if space suffices)
- on the packaging unit and the product

The BIC is machine-readable and contains information that can also be used by the customer for handling and product management.

Each piece of information can be uniquely identified using the so-called data identifier (ANSI MH10.8.2-2016). The data identifier is followed by a character string. Both together have a maximum length according to the table below. If the information is shorter, spaces are added to it.

Following information is possible, positions 1 to 4 are always present, the other according to need of production:

Position	Type of information	Explanation	Data identifier	Number of digits incl. data identifier	Example
1	Beckhoff order number	Beckhoff order number	1P	8	1P 072222
2	Beckhoff Traceability Number (BTN)	Unique serial number, see note below	SBTN	12	S BTNk4p562d7
3	Article description	Beckhoff article description, e.g. EL1008	1K	32	1K EL1809
4	Quantity	Quantity in packaging unit, e.g. 1, 10, etc.	Q	6	Q 1
5	Batch number	Optional: Year and week of production	2P	14	2P 401503180016
6	ID/serial number	Optional: Present-day serial number system, e.g. with safety products	51S	12	51S 678294
7	Variant number	Optional: Product variant number on the basis of standard products	30P	32	30P F971, 2*K183
...					

Further types of information and data identifiers are used by Beckhoff and serve internal processes.

Structure of the BIC

Example of composite information from positions 1 to 4 and with the above given example value on position 6. The data identifiers are highlighted in bold font:

1P072222**S**BTNk4p562d7**1K**EL1809 **Q**1 **51S**678294

Accordingly as DMC:



Fig. 60: Example DMC **1P**072222**S**BTNk4p562d7**1K**EL1809 **Q**1 **51S**678294

BTN

An important component of the BIC is the Beckhoff Traceability Number (BTN, position 2). The BTN is a unique serial number consisting of eight characters that will replace all other serial number systems at Beckhoff in the long term (e.g. batch designations on IO components, previous serial number range for safety products, etc.). The BTN will also be introduced step by step, so it may happen that the BTN is not yet coded in the BIC.

NOTE

This information has been carefully prepared. However, the procedure described is constantly being further developed. We reserve the right to revise and change procedures and documentation at any time and without prior notice. No claims for changes can be made from the information, illustrations and descriptions in this information.

7.4.4 Electronic access to the BIC (eBIC)

Electronic BIC (eBIC)

The Beckhoff Identification Code (BIC) is applied to the outside of Beckhoff products in a visible place. If possible, it should also be electronically readable.

Decisive for the electronic readout is the interface via which the product can be electronically addressed.

K-bus devices (IP20, IP67)

Currently, no electronic storage and readout is planned for these devices.

EtherCAT devices (IP20, IP67)

All Beckhoff EtherCAT devices have a so-called ESI-EEPROM, which contains the EtherCAT identity with the revision number. Stored in it is the EtherCAT slave information, also colloquially known as ESI/XML configuration file for the EtherCAT master. See the corresponding chapter in the EtherCAT system manual ([Link](#)) for the relationships.

The eBIC is also stored in the ESI-EEPROM. The eBIC was introduced into the Beckhoff I/O production (terminals, box modules) from 2020; widespread implementation is expected in 2021.

The user can electronically access the eBIC (if existent) as follows:

- With all EtherCAT devices, the EtherCAT master (TwinCAT) can read the eBIC from the ESI-EEPROM
 - From TwinCAT 3.1 build 4024.11, the eBIC can be displayed in the online view.
 - To do this, check the checkbox "Show Beckhoff Identification Code (BIC)" under EtherCAT → Advanced Settings → Diagnostics:

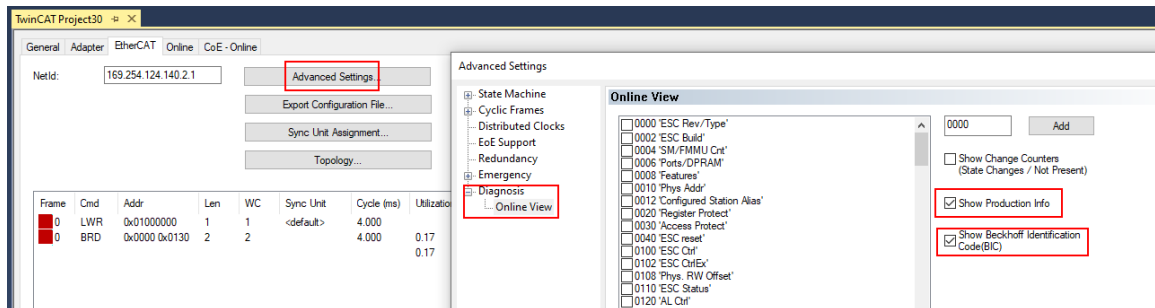

- The BTN and its contents are then displayed:

No	Addr	Name	State	CRC	Fw	Hw	Production Data	ItemNo	BTN	Description	Quantity	BatchNo	SerialNo
1	1001	Term 1 (EK1100)	OP	0,0	0	0	---						
2	1002	Term 2 (EL1018)	OP	0,0	0	0	2020 KW36 Fr	072222	k4p562d7	EL1809	1		678294
3	1003	Term 3 (EL3204)	OP	0,0	7	6	2012 KW24 Sa						
4	1004	Term 4 (EL2004)	OP	0,0	0	0	---	072223	k4p562d7	EL2004	1		678295
5	1005	Term 5 (EL1008)	OP	0,0	0	0	---						
6	1006	Term 6 (EL2008)	OP	0,0	0	12	2014 KW14 Mo						
7	1007	Term 7 (EK1110)	OP	0	1	8	2012 KW25 Mo						

- Note: as can be seen in the illustration, the production data HW version, FW version and production date, which have been programmed since 2012, can also be displayed with "Show Production Info".
- From TwinCAT 3.1. build 4024.24 the functions *FB_EcReadBIC* and *FB_EcReadBTN* for reading into the PLC and further eBIC auxiliary functions are available in the Tc2_EtherCAT Library from v3.3.19.0.
- In the case of EtherCAT devices with CoE directory, the object 0x10E2:01 can additionally be used to display the device's own eBIC; the PLC can also simply access the information here:

- The device must be in PREOP/SAFEOP/OP for access:

Index	Name	Flags	Value
1000	Device type	RO	0x015E1389 (22942601)
1008	Device name	RO	ELM3704-0000
1009	Hardware version	RO	00
100A	Software version	RO	01
100B	Bootloader version	RO	J0.1.27.0
1011:0	Restore default parameters	RO	> 1 <
1018:0	Identity	RO	> 4 <
10E2:0	Manufacturer-specific Identification C...	RO	> 1 <
10E2:01	SubIndex 001	RO	1P158442SBTN0008jekp1KELM3704 Q1 2P482001000016
10F0:0	Backup parameter handling	RO	> 1 <
10F3:0	Diagnosis History	RO	> 21 <
10F8	Actual Time Stamp	RO	0x170bfb277e

- the object 0x10E2 will be introduced into stock products in the course of a necessary firmware revision.
- From TwinCAT 3.1. build 4024.24 the functions *FB_EcCoEReadBIC* and *FB_EcCoEReadBTN* for reading into the PLC and further eBIC auxiliary functions are available in the *Tc2_EtherCAT Library* from v3.3.19.0.
- Note: in the case of electronic further processing, the BTN is to be handled as a string(8); the identifier "SBTN" is not part of the BTN.
- Technical background
The new BIC information is additionally written as a category in the ESI-EEPROM during the device production. The structure of the ESI content is largely dictated by the ETG specifications, therefore the additional vendor-specific content is stored with the help of a category according to ETG.2010. ID 03 indicates to all EtherCAT masters that they must not overwrite these data in case of an update or restore the data after an ESI update.
The structure follows the content of the BIC, see there. This results in a memory requirement of approx. 50..200 bytes in the EEPROM.
- Special cases
 - If multiple, hierarchically arranged ESCs are installed in a device, only the top-level ESC carries the eBIC Information.
 - If multiple, non-hierarchically arranged ESCs are installed in a device, all ESCs carry the eBIC Information.
 - If the device consists of several sub-devices with their own identity, but only the top-level device is accessible via EtherCAT, the eBIC of the top-level device is located in the CoE object directory 0x10E2:01 and the eBICs of the sub-devices follow in 0x10E2:nn.

Profibus/Profinet/DeviceNet... Devices

Currently, no electronic storage and readout is planned for these devices.

7.5 Support and Service

Beckhoff and their partners around the world offer comprehensive support and service, making available fast and competent assistance with all questions related to Beckhoff products and system solutions.

Beckhoff's branch offices and representatives

Please contact your Beckhoff branch office or representative for local support and service on Beckhoff products!

The addresses of Beckhoff's branch offices and representatives round the world can be found on her internet pages: <https://www.beckhoff.com>

You will also find further documentation for Beckhoff components there.

Beckhoff Support

Support offers you comprehensive technical assistance, helping you not only with the application of individual Beckhoff products, but also with other, wide-ranging services:

- support
- design, programming and commissioning of complex automation systems
- and extensive training program for Beckhoff system components

Hotline: +49 5246 963 157
Fax: +49 5246 963 9157
e-mail: support@beckhoff.com

Beckhoff Service

The Beckhoff Service Center supports you in all matters of after-sales service:

- on-site service
- repair service
- spare parts service
- hotline service

Hotline: +49 5246 963 460
Fax: +49 5246 963 479
e-mail: service@beckhoff.com

Beckhoff Headquarters

Beckhoff Automation GmbH & Co. KG

Huelshorstweg 20
33415 Verl
Germany

Phone: +49 5246 963 0
Fax: +49 5246 963 198
e-mail: info@beckhoff.com
web: <https://www.beckhoff.com>

More Information:
www.beckhoff.com/ep3632-0001

Beckhoff Automation GmbH & Co. KG
Hülshorstweg 20
33415 Verl
Germany
Phone: +49 5246 9630
info@beckhoff.com
www.beckhoff.com

