

Documentation | EN

# EP2624-0002

4-channel relay output





# Table of contents

|  |           |
|--|-----------|
| <b>1 Foreword</b> .....                                      | <b>5</b>  |
| 1.1 Notes on the documentation .....                         | 5         |
| 1.2 Safety instructions .....                                | 6         |
| 1.3 Documentation issue status .....                         | 7         |
| <b>2 EtherCAT Box - Introduction</b> .....                   | <b>8</b>  |
| <b>3 Product overview</b> .....                              | <b>10</b> |
| 3.1 Introduction .....                                       | 10        |
| 3.2 Technical data .....                                     | 11        |
| 3.3 Scope of supply.....                                     | 12        |
| 3.4 Process image .....                                      | 13        |
| <b>4 Mounting and connection</b> .....                       | <b>14</b> |
| 4.1 Mounting .....   | 14        |
| 4.1.1 Dimensions .....                                       | 14        |
| 4.1.2 Fixing.....  | 15        |
| 4.2 Connections .....  | 16        |
| 4.2.1 Tightening torques for plug connectors.....            | 16        |
| 4.2.2 EtherCAT .....   | 17        |
| 4.2.3 Supply voltages.....                                   | 19        |
| 4.2.4 Relay .....  | 22        |
| 4.3 UL Requirements .....                                    | 23        |
| 4.4 ATEX notes .....   | 24        |
| 4.4.1 ATEX - Special conditions.....                         | 24        |
| 4.4.2 BG2000 - EtherCAT Box protection enclosures.....       | 25        |
| 4.4.3 ATEX Documentation.....                                | 26        |
| 4.5 Disposal .....   | 27        |
| <b>5 Commissioning and configuration</b> .....               | <b>28</b> |
| 5.1 Integration in TwinCAT .....                             | 28        |
| 5.2 Decommissioning .....                                    | 28        |
| <b>6 Appendix</b> .....                                      | <b>29</b> |
| 6.1 General operating conditions .....                       | 29        |
| 6.2 Accessories .....  | 30        |
| 6.3 Version identification of EtherCAT devices .....         | 31        |
| 6.3.1 General notes on marking.....                          | 31        |
| 6.3.2 Version identification of EP/EPI/EPP/ER/ERI boxes..... | 32        |
| 6.3.3 Beckhoff Identification Code (BIC).....                | 33        |
| 6.3.4 Electronic access to the BIC (eBIC).....               | 35        |
| 6.4 Support and Service.....                                 | 37        |



# 1 Foreword

## 1.1 Notes on the documentation

### Intended audience

This description is only intended for the use of trained specialists in control and automation engineering who are familiar with the applicable national standards.

It is essential that the documentation and the following notes and explanations are followed when installing and commissioning these components.

It is the duty of the technical personnel to use the documentation published at the respective time of each installation and commissioning.

The responsible staff must ensure that the application or use of the products described satisfy all the requirements for safety, including all the relevant laws, regulations, guidelines and standards.

### Disclaimer

The documentation has been prepared with care. The products described are, however, constantly under development.

We reserve the right to revise and change the documentation at any time and without prior announcement.

No claims for the modification of products that have already been supplied may be made on the basis of the data, diagrams and descriptions in this documentation.

### Trademarks

Beckhoff®, TwinCAT®, TwinCAT/BSD®, TC/BSD®, EtherCAT®, EtherCAT G®, EtherCAT G10®, EtherCAT P®, Safety over EtherCAT®, TwinSAFE®, XFC®, XTS® and XPlanar® are registered trademarks of and licensed by Beckhoff Automation GmbH. Other designations used in this publication may be trademarks whose use by third parties for their own purposes could violate the rights of the owners.

### Patent Pending

The EtherCAT Technology is covered, including but not limited to the following patent applications and patents: EP1590927, EP1789857, EP1456722, EP2137893, DE102015105702 with corresponding applications or registrations in various other countries.



EtherCAT® is registered trademark and patented technology, licensed by Beckhoff Automation GmbH, Germany.

### Copyright

© Beckhoff Automation GmbH & Co. KG, Germany.

The reproduction, distribution and utilization of this document as well as the communication of its contents to others without express authorization are prohibited.

Offenders will be held liable for the payment of damages. All rights reserved in the event of the grant of a patent, utility model or design.

## 1.2 Safety instructions

### Safety regulations

Please note the following safety instructions and explanations!  
Product-specific safety instructions can be found on following pages or in the areas mounting, wiring, commissioning etc.

### Exclusion of liability

All the components are supplied in particular hardware and software configurations appropriate for the application. Modifications to hardware or software configurations other than those described in the documentation are not permitted, and nullify the liability of Beckhoff Automation GmbH & Co. KG.

### Personnel qualification

This description is only intended for trained specialists in control, automation and drive engineering who are familiar with the applicable national standards.

### Description of instructions

In this documentation the following instructions are used.  
These instructions must be read carefully and followed without fail!

#### DANGER

##### **Serious risk of injury!**

Failure to follow this safety instruction directly endangers the life and health of persons.

#### WARNING

##### **Risk of injury!**

Failure to follow this safety instruction endangers the life and health of persons.

#### CAUTION

##### **Personal injuries!**

Failure to follow this safety instruction can lead to injuries to persons.

#### NOTE

##### **Damage to environment/equipment or data loss**

Failure to follow this instruction can lead to environmental damage, equipment damage or data loss.



##### **Tip or pointer**

This symbol indicates information that contributes to better understanding.

## 1.3 Documentation issue status

| Version | Comment   |
|---------|---|
| 3.2     | <ul style="list-style-type: none"> <li>• Dimensions updated</li> <li>• UL requirements updated</li> <li>• Technical data updated</li> </ul> |
| 3.1     | <ul style="list-style-type: none"> <li>• Front page updated</li> <li>• Scope of delivery added</li> </ul>                                   |
| 3.0     | Documentation separated from EP2xxx 2.9.2   |
| 3.3     | • Chapter "Supply voltages" updated   |

### Firmware and hardware versions

This documentation refers to the firmware and hardware version that was applicable at the time the documentation was written.

The module features are continuously improved and developed further. Modules having earlier production statuses cannot have the same properties as modules with the latest status. However, existing properties are retained and are not changed, so that older modules can always be replaced with new ones.

The firmware and hardware version (delivery state) can be found in the batch number (D-number) printed on the side of the EtherCAT Box.

### Syntax of the batch number (D-number)

D: WW YY FF HH

WW - week of production (calendar week)

YY - year of production

FF - firmware version

HH - hardware version

Example with D no. 29 10 02 01:

29 - week of production 29

10 - year of production 2010

02 - firmware version 02

01 - hardware version 01

Further information on this topic: [Version identification of EtherCAT devices \[► 31\]](#).

## 2 EtherCAT Box - Introduction

The EtherCAT system has been extended with EtherCAT Box modules with protection class IP67. Through the integrated EtherCAT interface the modules can be connected directly to an EtherCAT network without an additional Coupler Box. The high-performance of EtherCAT is thus maintained into each module.

The extremely low dimensions of only 126 x 30 x 26.5 mm (h x w x d) are identical to those of the Fieldbus Box extension modules. They are thus particularly suitable for use where space is at a premium. The small mass of the EtherCAT modules facilitates applications with mobile I/O interface (e.g. on a robot arm). The EtherCAT connection is established via screened M8 connectors.

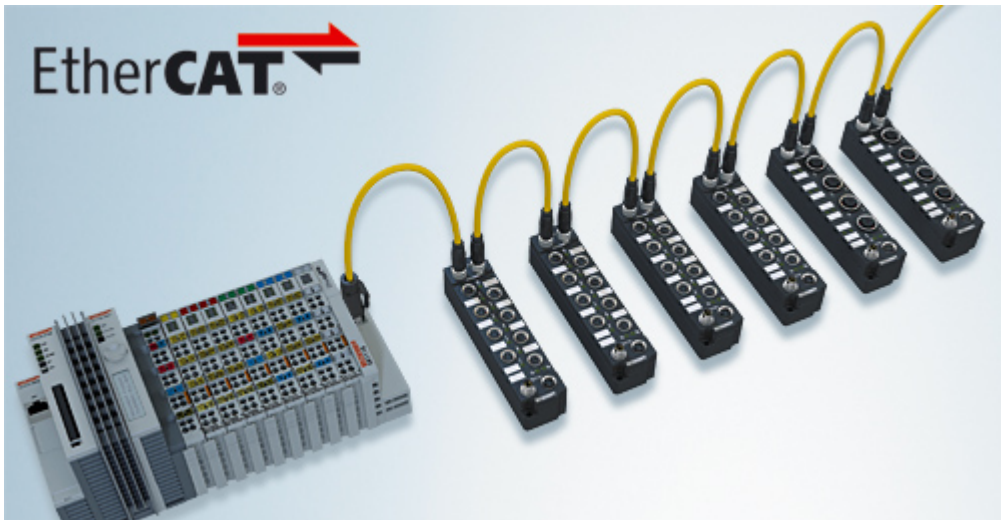

Fig. 1: EtherCAT Box Modules within an EtherCAT network

The robust design of the EtherCAT Box modules enables them to be used directly at the machine. Control cabinets and terminal boxes are now no longer required. The modules are fully sealed and therefore ideally prepared for wet, dirty or dusty conditions.

Pre-assembled cables significantly simplify EtherCAT and signal wiring. Very few wiring errors are made, so that commissioning is optimized. In addition to pre-assembled EtherCAT, power and sensor cables, field-configurable connectors and cables are available for maximum flexibility. Depending on the application, the sensors and actuators are connected through M8 or M12 connectors.

The EtherCAT modules cover the typical range of requirements for I/O signals with protection class IP67:

- digital inputs with different filters (3.0 ms or 10  $\mu$ s)
- digital outputs with 0.5 or 2 A output current
- analog inputs and outputs with 16 bit resolution
- Thermocouple and RTD inputs
- Stepper motor modules

XFC (eXtreme Fast Control Technology) modules, including inputs with time stamp, are also available.





Fig. 2: EtherCAT Box with M8 connections for sensors/actuators



Fig. 3: EtherCAT Box with M12 connections for sensors/actuators

---

**● Basic EtherCAT documentation**



You will find a detailed description of the EtherCAT system in the Basic System Documentation for EtherCAT, which is available for download from our website ([www.beckhoff.com](http://www.beckhoff.com)) under Downloads.

---

## 3 Product overview

### 3.1 Introduction

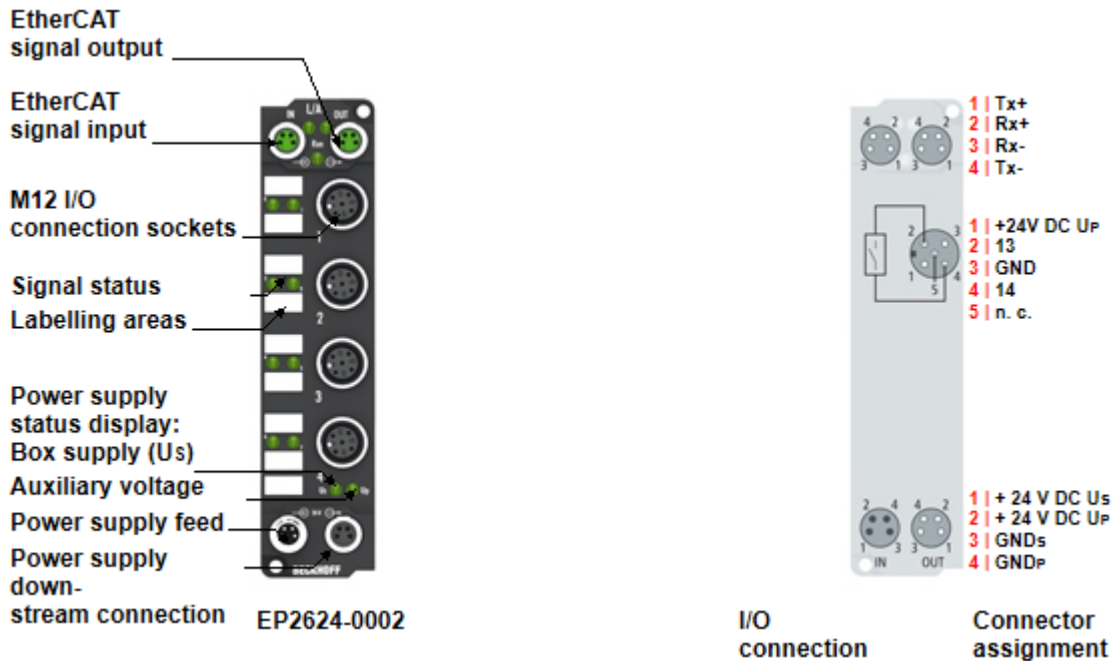

Fig. 4: EP2624-0002

#### 4-channel relay output, 25 V<sub>AC</sub> / 30 V<sub>DC</sub>

The EP2624 EtherCAT Box has four relays each of which has a single contact. The relay contact is suitable for use at up to 25 V<sub>AC</sub> or 30 V<sub>DC</sub>. The EtherCAT Box indicates its signal state by means of light emitting diodes. The EP2624 has potential-free contacts. The power supply is looped through.

#### Quick links

- [Technical data \[▶ 11\]](#)
- [Process image \[▶ 13\]](#)
- [Dimensions \[▶ 14\]](#)
- [Relay connections \[▶ 22\]](#)

## 3.2 Technical data

All values are typical values over the entire temperature range, unless stated otherwise.

| EtherCAT             |                             |
|----------------------|-----------------------------|
| Connection           | 2 x M8 socket, 4-pin, green |
| Electrical isolation | 500 V                       |

| Supply voltages  |  |
|--|--|
| Connection   | Input: M8 connector, 4-pin<br>Downstream connection: M8 socket, 4-pin, black |
| $U_S$ nominal voltage                                    | 24 V <sub>DC</sub> (-15 % / +20 %)   |
| $U_S$ sum current: $I_{S,sum}$                           | max. 4 A   |
| Current consumption from $U_S$                           | 200 mA   |
| Rated voltage $U_P$                                      | 24 V <sub>DC</sub> (-15 % / +20 %)   |
| $U_P$ sum current: $I_{P,sum}$                           | max. 4 A   |
| Current consumption from $U_P$                           | None. $U_P$ is only forwarded.   |
| Electrical isolation GND <sub>S</sub> / GND <sub>P</sub> | no   |

| Relay outputs               |  |
|-----------------------------|--|
| Number                      | 4 make contacts                                      |
| Connection                  | 4 x M12 socket                                       |
| Load type                   | ohmic, inductive, lamp load                          |
| Nominal voltage             | 25 V <sub>AC</sub> / 30 V <sub>DC</sub>              |
| Ohmic switching current     | 0.5 A <sub>AC</sub> / 2 A <sub>DC</sub> per channel  |
| Minimum permitted load      | 10 µA at 10 mV <sub>DC</sub>                         |
| Mechanical switching cycles | min. 1 x 10 <sup>8</sup>                             |
| Electrical switching cycles | min. 2 x 10 <sup>5</sup> (1 A / 30 V <sub>DC</sub> ) |

| Housing data          |   |
|-----------------------|---|
| Dimensions W x H x D  | 30 mm x 126 mm x 26.5 mm (without connectors) |
| Weight                | approx. 165 g                                 |
| Installation position | variable                                      |
| Material              | PA6 (polyamide)                               |

| Environmental conditions               |  |
|--|--|
| Ambient temperature during operation   | -25...+60 °C<br>-25...+55 °C according to cURus<br>0...+55 °C according to ATEX                    |
| Ambient temperature during storage     | -40 ... +85 °C   |
| Vibration resistance, shock resistance | conforms to EN 60068-2-6 / EN 60068-2-27<br><a href="#">Additional checks</a> <a href="#">▶ 12</a> |
| EMC immunity / emission                | conforms to EN 61000-6-2 / EN 61000-6-4  |
| Protection rating                      | IP65, IP66, IP67 (according to EN 60529)   |

| Approvals / markings    |  |
|-------------------------|--|
| Approvals / markings *) | ATEX <a href="#">▶ 24</a> , CE, cURus <a href="#">▶ 23</a> |

\*) Real applicable approvals/markings see type plate on the side (product marking).

### Additional checks

The boxes have been subjected to the following checks:

| Verification | Explanation   |
|--------------|---|
| Vibration    | 10 frequency sweeps in 3 axes                             |
|              | 5 Hz < f < 60 Hz displacement 0.35 mm, constant amplitude |
|              | 60.1 Hz < f < 500 Hz acceleration 5 g, constant amplitude |
| Shocks       | 1000 shocks in each direction, in 3 axes                  |
|              | 35 g, 11 ms   |

## 3.3 Scope of supply

Make sure that the following components are included in the scope of delivery:

- 1x EtherCAT Box EP2624-0002
- 2x protective cap for EtherCAT socket, M8, green (pre-assembled)
- 1x protective cap for supply voltage input, M8, transparent (pre-assembled)
- 1x protective cap for supply voltage output, M8, black (pre-assembled)
- 10x labels, blank (1 strip of 10)

---

### ● Pre-assembled protective caps do not ensure IP67 protection

**i** Protective caps are pre-assembled at the factory to protect connectors during transport. They may not be tight enough to ensure IP67 protection.











Ensure that the protective caps are correctly seated to ensure IP67 protection.

---



## 3.4 Process image

### Channel 1 to Channel 4

Under **Channel 1** to **Channel 4** you will find the 4 digital outputs of the module.

- ▲  Box 1 (EP2624-0002)
  - ▲  Channel 1
    - ▶  Output
  - ▲  Channel 2
    - ▶  Output
  - ▲  Channel 3
    - ▶  Output
  - ▲  Channel 4
    - ▶  Output
  - ▶  WcState
  - ▶  InfoData

### Data types

-  Channel n
  - ▶  Output: **BIT**

## 4 Mounting and connection

### 4.1 Mounting

#### 4.1.1 Dimensions

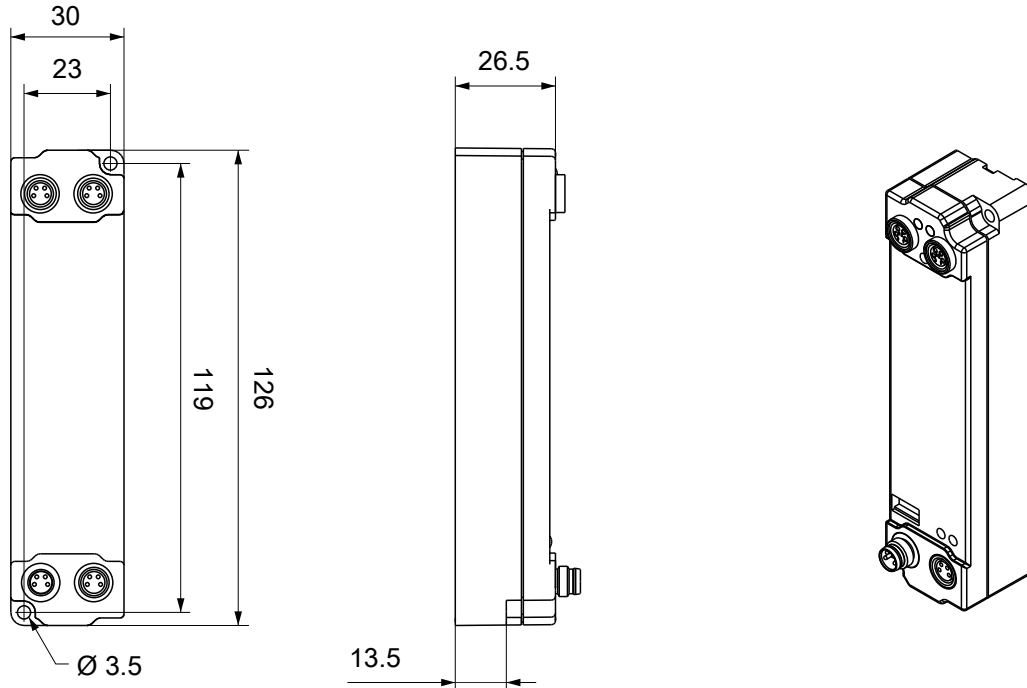

All dimensions are given in millimeters.  
The drawing is not true to scale.

#### Housing features

|                        |   |
|------------------------|---|
| Housing material       | PA6 (polyamide)   |
| Sealing compound       | polyurethane  |
| Mounting               | two mounting holes $\varnothing 3.5$ mm for M3                |
| Metal parts            | brass, nickel-plated  |
| Contacts               | CuZn, gold-plated   |
| Power feed through     | max. 4 A  |
| Installation position  | variable  |
| Protection class       | IP65, IP66, IP67 (conforms to EN 60529) when screwed together |
| Dimensions (H x W x D) | approx. 126 x 30 x 26.5 mm (without connectors)               |

## 4.1.2 Fixing

### NOTE

#### Dirt during assembly

Dirty connectors can lead to malfunctions. Protection class IP67 can only be guaranteed if all cables and connectors are connected.

- Protect the plug connectors against dirt during the assembly.

Mount the module with two M3 screws on the mounting holes in the corners of the module. The mounting holes have no thread.

## 4.2 Connections

### 4.2.1 Tightening torques for plug connectors

Screw connectors tight with a torque wrench. (e.g. ZB8801 from Beckhoff)

| Connector diameter | Tightening torque |
|--------------------|-------------------|
| M8                 | 0.4 Nm            |
| M12                | 0.6 Nm            |



## 4.2.2 EtherCAT

### 4.2.2.1 Connectors

**NOTE**

**Risk of confusion: supply voltages and EtherCAT**

Defect possible through incorrect insertion.

- Observe the color coding of the connectors:  
black: Supply voltages  
green: EtherCAT

EtherCAT Box Modules have two green M8 sockets for the incoming and downstream EtherCAT connections.



#### Connection

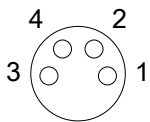

Fig. 5: M8 socket

| EtherCAT | M8 connector | Core colors   |   |              |
|----------|--------------|---|---|--------------|
| Signal   | Contact      | ZB9010, ZB9020, ZB9030, ZB9032, ZK1090-6292, ZK1090-3xxx-xxxx | ZB9031 and old versions of ZB9030, ZB9032, ZK1090-3xxx-xxxx | TIA-568B     |
| Tx +     | 1            | yellow <sup>1)</sup>  | orange/white  | white/orange |
| Tx -     | 4            | orange <sup>1)</sup>  | orange  | orange       |
| Rx +     | 2            | white <sup>1)</sup>   | blue/white  | white/green  |
| Rx -     | 3            | blue <sup>1)</sup>  | blue  | green        |
| Shield   | Housing      | Shield  | Shield  | Shield       |

<sup>1)</sup> Core colors according to EN 61918

**i Adaptation of core colors for cables ZB9030, ZB9032 and ZK1090-3xxxx-xxxx**

For standardization, the core colors of the ZB9030, ZB9032 and ZK1090-3xxx-xxxx cables have been changed to the EN61918 core colors: yellow, orange, white, blue. So there are different color codes in circulation. The electrical properties of the cables have been retained when the core colors were changed.

### 4.2.2.2 Status LEDs



#### L/A (Link/Act)

A green LED labelled "L/A" is located next to each EtherCAT socket. The LED indicates the communication state of the respective socket:

| LED     | Meaning   |
|---------|---|
| off     | no connection to the connected EtherCAT device        |
| lit     | LINK: connection to the connected EtherCAT device     |
| flashes | ACT: communication with the connected EtherCAT device |

#### Run

Each EtherCAT slave has a green LED labelled "Run". The LED signals the status of the slave in the EtherCAT network:

| LED                  | Meaning                              |
|----------------------|--------------------------------------|
| off                  | Slave is in "Init" state             |
| flashes uniformly    | Slave is in "Pre-Operational" state  |
| flashes sporadically | Slave is in "Safe-Operational" state |
| lit                  | Slave is in "Operational" state      |

[Description of the EtherCAT slave states](#)

### 4.2.2.3 Cables

For connecting EtherCAT devices only shielded Ethernet cables that meet the requirements of at least category 5 (CAT5) according to EN 50173 or ISO/IEC 11801 should be used.

EtherCAT uses four wires for signal transmission.

Thanks to automatic line detection ("Auto MDI-X"), both symmetrical (1:1) or cross-over cables can be used between Beckhoff EtherCAT.

[Detailed recommendations for the cabling of EtherCAT devices](#)

### 4.2.3 Supply voltages

#### ⚠ WARNING

##### Power supply from SELV/PELV power supply unit!

SELV/PELV circuits (Safety Extra Low Voltage, Protective Extra Low Voltage) according to IEC 61010-2-201 must be used to supply this device.

Notes:

- SELV/PELV circuits may give rise to further requirements from standards such as IEC 60204-1 et al, for example with regard to cable spacing and insulation.
- A SELV (Safety Extra Low Voltage) supply provides safe electrical isolation and limitation of the voltage without a connection to the protective conductor, a PELV (Protective Extra Low Voltage) supply also requires a safe connection to the protective conductor.

#### ⚠ CAUTION

##### Observe the UL requirements

- When operating under UL conditions, observe the warnings in the chapter [UL Requirements \[► 23\]](#).

The EtherCAT Box has one input for two supply voltages:

- **Control voltage  $U_s$**   
The following sub-functions are supplied from the control voltage  $U_s$ :
  - the fieldbus
  - the processor logic
  - typically the inputs and the sensors if the EtherCAT Box has inputs.
- **Peripheral voltage  $U_p$**   
For EtherCAT Box modules with digital outputs the digital outputs are typically supplied from the peripheral voltage  $U_p$ .  $U_p$  can be supplied separately. If  $U_p$  is switched off, the fieldbus function, the function of the inputs and the supply of the sensors are maintained.

The exact assignment of  $U_s$  and  $U_p$  can be found in the pin assignment of the I/O connections.

#### Redirection of the supply voltages

The power IN and OUT connections are bridged in the module. Hence, the supply voltages  $U_s$  and  $U_p$  can be passed from EtherCAT Box to EtherCAT Box in a simple manner.

#### NOTE

##### Note the maximum current!

Ensure that the permitted current for the connectors is not exceeded when routing the supply voltages  $U_s$  and  $U_p$ :

M8 connector: max. 4 A  
7/8" connector: max 16 A

#### NOTE

##### Unintentional cancellation of the electrical isolation of $GND_s$ and $GND_p$ possible.

In some types of EtherCAT Box modules the ground potentials  $GND_s$  and  $GND_p$  are connected.

- If several EtherCAT Box modules are supplied with the same electrically isolated voltages, check whether there is an EtherCAT Box among them in which the ground potentials are connected.

### 4.2.3.1 Connectors

**NOTE**

**Risk of confusion: supply voltages and EtherCAT**

Defect possible through incorrect insertion.

- Observe the color coding of the connectors:  
 black: Supply voltages  
 green: EtherCAT

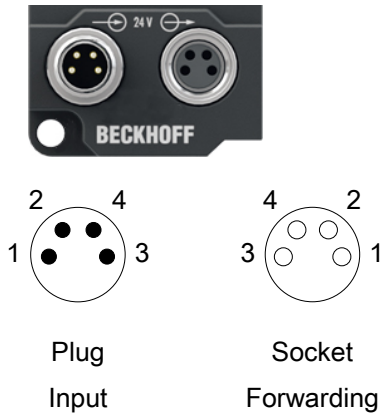

Fig. 6: M8 connector

| Contact | Function | Description        | Core color <sup>1)</sup> |
|---------|----------|--------------------|--------------------------|
| 1       | $U_S$    | Control voltage    | Brown                    |
| 2       | $U_P$    | Peripheral voltage | White                    |
| 3       | $GND_S$  | GND to $U_S$       | Blue                     |
| 4       | $GND_P$  | GND to $U_P$       | Black                    |

<sup>1)</sup> The core colors apply to cables of the type: Beckhoff ZK2020-3xxx-xxxx

### 4.2.3.2 Status LEDs



| LED                        | Display           | Meaning                                    |
|----------------------------|-------------------|--|
| $U_S$ (control voltage)    | off               | The supply voltage $U_S$ is not available. |
|                            | green illuminated | The supply voltage $U_S$ is available.     |
| $U_P$ (peripheral voltage) | off               | The supply voltage $U_P$ is not available. |
|                            | green illuminated | The supply voltage $U_P$ is available.     |

### 4.2.3.3 Conductor losses

Take into account the voltage drop on the supply line when planning a system. Avoid the voltage drop being so high that the supply voltage at the box lies below the minimum nominal voltage. Variations in the voltage of the power supply unit must also be taken into account.

#### Voltage drop on the supply line

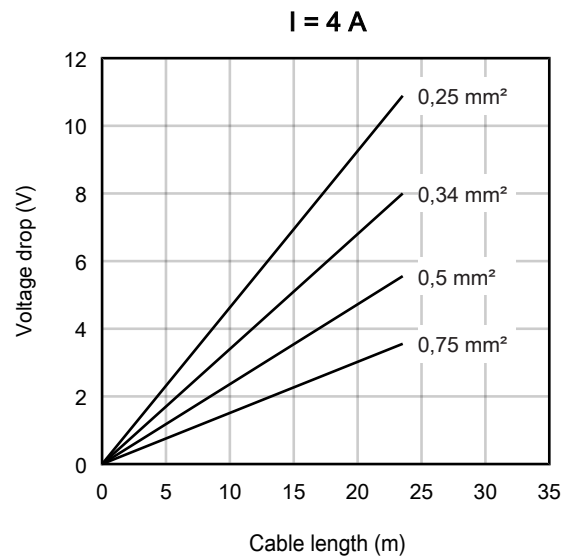
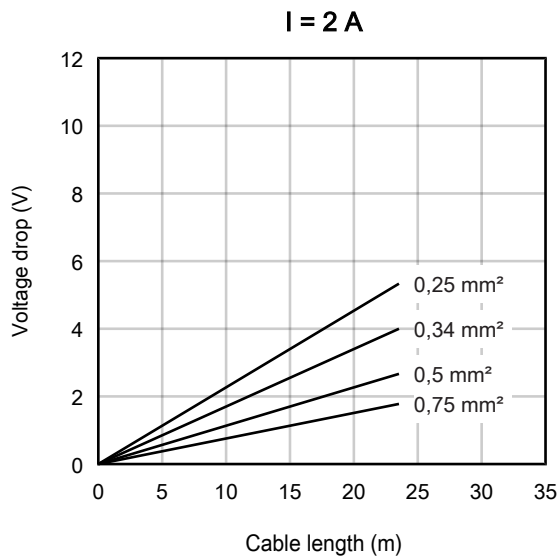

## 4.2.4 Relay

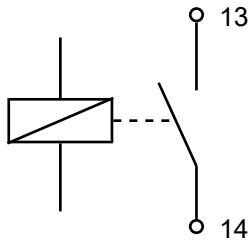

Fig. 7: Relay connections

### Pin assignment

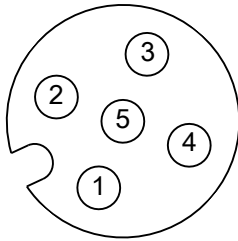

Fig. 8: M12 socket

| Pin | Function                          | Core color <sup>1)</sup> |
|-----|-----------------------------------|--------------------------|
| 1   | 24 V <sub>DC</sub> U <sub>P</sub> | brown                    |
| 2   | Relay connection 13               | white                    |
| 3   | GND <sub>P</sub>                  | blue                     |
| 4   | Relay connection 14               | black                    |
| 5   | -                                 | grey                     |

<sup>1)</sup> The core colors apply to M12 cables from Beckhoff:

- ZK2000-5xxx
- ZK2000-6xxx
- ZK2000-7xxx

### Status LEDs

There are two LEDs next to each M12 socket. The LED on the left turns green when the relay contact is closed. The LED on the right has no function.



Fig. 9: Status LEDs of M12 sockets

## 4.3 UL Requirements

The installation of the EtherCAT Box Modules certified by UL has to meet the following requirements.

### Supply voltage

#### ⚠ CAUTION

##### CAUTION!

This UL requirements are valid for all supply voltages of all marked EtherCAT Box Modules!  
For the compliance of the UL requirements the EtherCAT Box Modules should only be supplied

- by a 24 V<sub>DC</sub> supply voltage, supplied by an isolating source and protected by means of a fuse (in accordance with UL248), rated maximum 4 Amp, or
- by a 24 V<sub>DC</sub> power source, that has to satisfy *NEC class 2*.  
A *NEC class 2* power supply shall not be connected in series or parallel with another (class 2) power source!

#### ⚠ CAUTION

##### CAUTION!

To meet the UL requirements, the EtherCAT Box Modules must not be connected to unlimited power sources!

### Networks

#### ⚠ CAUTION

##### CAUTION!

To meet the UL requirements, EtherCAT Box Modules must not be connected to telecommunication networks!

### Ambient temperature range

#### ⚠ CAUTION

##### CAUTION!

To meet the UL requirements, EtherCAT Box Modules has to be operated only at an ambient temperature range of -25 °C to +55 °C!

### Marking for UL

All EtherCAT Box Modules certified by UL (Underwriters Laboratories) are marked with the following label.



Fig. 10: UL label

## 4.4 ATEX notes

### 4.4.1 ATEX - Special conditions

#### ⚠ WARNING

**Observe the special conditions for the intended use of EtherCAT Box modules in potentially explosive areas – directive 94/9/EU.**

- The certified components are to be installed with a BG2000-0000 or BG2000-0010 protection enclosure [► 25] that guarantees a protection against mechanical hazards!
- If the temperatures during rated operation are higher than 70°C at the feed-in points of cables, lines or pipes, or higher than 80°C at the wire branching points, then cables must be selected whose temperature data correspond to the actual measured temperature values!
- Observe the permissible ambient temperature range of 0 to 55°C for the use of EtherCAT Box modules in potentially explosive areas!
- Measures must be taken to protect against the rated operating voltage being exceeded by more than 40% due to short-term interference voltages!
- The connections of the certified components may only be connected or disconnected if the supply voltage has been switched off or if a non-explosive atmosphere is ensured!

#### Standards

The fundamental health and safety requirements are fulfilled by compliance with the following standards:

- EN 60079-0: 2006
- EN 60079-15: 2005

#### Marking

The EtherCAT Box modules certified for potentially explosive areas bear the following marking:



II 3 G Ex nA II T4 DEKRA 11ATEX0080 X Ta: 0 - 55°C

or



II 3 G Ex nA nC IIC T4 DEKRA 11ATEX0080 X Ta: 0 - 55°C

#### Batch number (D number)

The EtherCAT Box modules bear a batch number (D number) that is structured as follows:

D: WW YY FF HH

WW - week of production (calendar week)

YY - year of production

FF - firmware version

HH - hardware version

Example with batch number 29 10 02 01:

29 - week of production 29

10 - year of production 2010

02 - firmware version 02

01 - hardware version 01



## 4.4.2 BG2000 - EtherCAT Box protection enclosures

### ⚠ WARNING

#### Risk of electric shock and damage of device!

Bring the EtherCAT system into a safe, powered down state before starting installation, disassembly or wiring of the modules!

### ATEX

### ⚠ WARNING

#### Mount a protection enclosure!

To fulfill the special conditions according to ATEX [▶ 24], a BG2000-0000 or BG2000-0010 protection enclosure has to be mounted over the EtherCAT Box.

### Installation

Put the cables for EtherCAT, power supply and sensors/actuators through the hole of the protection enclosure.

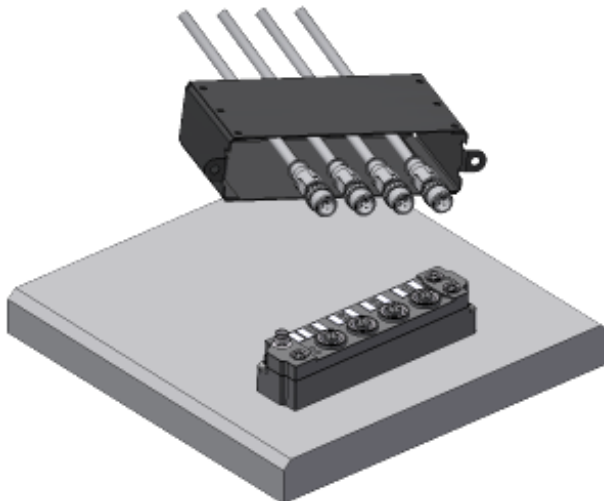

Fig. 11: BG2000 - putting the cables

Fix the wires for EtherCAT, power supply and sensors/actuators to the EtherCAT Box.

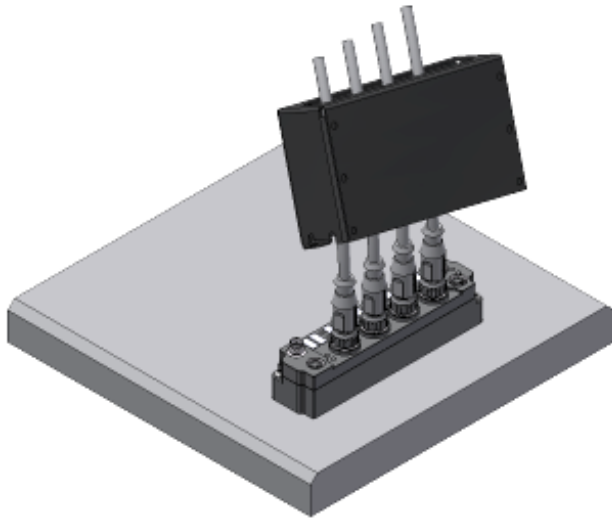

Fig. 12: BG2000 - fixing the cables

Mount the protection enclosure over the EtherCAT Box.

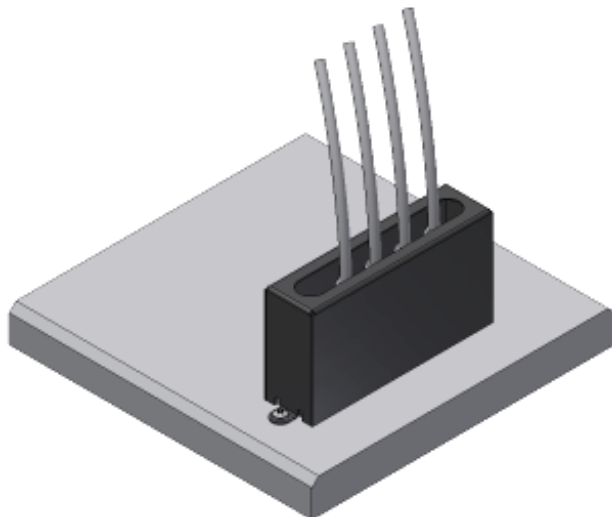

Fig. 13: BG2000 - mounting the protection enclosure

#### 4.4.3 ATEX Documentation



##### Notes about operation of EtherCAT Box Modules (EPxxxx-xxxx) in potentially explosive areas (ATEX)

Pay also attention to the continuative documentation Notes about operation of EtherCAT Box Modules (EPxxxx-xxxx) in potentially explosive areas (ATEX) that is available in the download area of the Beckhoff homepage <http://www.beckhoff.com>!

## 4.5 Disposal



Products marked with a crossed-out wheeled bin shall not be discarded with the normal waste stream. The device is considered as waste electrical and electronic equipment. The national regulations for the disposal of waste electrical and electronic equipment must be observed.

## 5 Commissioning and configuration

### 5.1 Integration in TwinCAT

The procedure for integration in TwinCAT is described in this [Quick start guide](#).

### 5.2 Decommissioning

 **WARNING**

**Risk of electric shock!**

Bring the bus system into a safe, de-energized state before starting disassembly of the devices!

# 6 Appendix

## 6.1 General operating conditions

### Protection degrees (IP-Code)

The standard IEC 60529 (DIN EN 60529) defines the degrees of protection in different classes.

| 1. Number: dust protection and touch guard | Definition  |
|--|---|
| 0  | Non-protected   |
| 1  | Protected against access to hazardous parts with the back of a hand. Protected against solid foreign objects of Ø 50 mm   |
| 2  | Protected against access to hazardous parts with a finger. Protected against solid foreign objects of Ø 12.5 mm.  |
| 3  | Protected against access to hazardous parts with a tool. Protected against solid foreign objects Ø 2.5 mm.  |
| 4  | Protected against access to hazardous parts with a wire. Protected against solid foreign objects Ø 1 mm.  |
| 5  | Protected against access to hazardous parts with a wire. Dust-protected. Intrusion of dust is not totally prevented, but dust shall not penetrate in a quantity to interfere with satisfactory operation of the device or to impair safety. |
| 6  | Protected against access to hazardous parts with a wire. Dust-tight. No intrusion of dust.  |
| 2. Number: water* protection               | Definition  |
| 0  | Non-protected   |
| 1  | Protected against water drops   |
| 2  | Protected against water drops when enclosure tilted up to 15°.  |
| 3  | Protected against spraying water. Water sprayed at an angle up to 60° on either side of the vertical shall have no harmful effects.   |
| 4  | Protected against splashing water. Water splashed against the disclosure from any direction shall have no harmful effects   |
| 5  | Protected against water jets  |
| 6  | Protected against powerful water jets   |
| 7  | Protected against the effects of temporary immersion in water. Intrusion of water in quantities causing harmful effects shall not be possible when the enclosure is temporarily immersed in water for 30 min. in 1 m depth.                 |

\*) These protection classes define only protection against water.

### Chemical Resistance

The Resistance relates to the Housing of the IP67 modules and the used metal parts. In the table below you will find some typical resistance.

| Character                          | Resistance  |
|------------------------------------|---|
| Steam                              | at temperatures >100°C: not resistant                   |
| Sodium base liquor (ph-Value > 12) | at room temperature: resistant<br>> 40°C: not resistant |
| Acetic acid                        | not resistant   |
| Argon (technical clean)            | resistant   |

### Key

- resistant: Lifetime several months
- non inherently resistant: Lifetime several weeks
- not resistant: Lifetime several hours resp. early decomposition

## 6.2 Accessories

### Mounting

| Ordering information | Description   | Link                    |
|----------------------|---------------|-------------------------|
| ZS5300-0011          | Mounting rail | <a href="#">Website</a> |

### Cables

A complete overview of pre-assembled cables for fieldbus components can be found [here](#).

| Ordering information | Description                      | Link                    |
|----------------------|----------------------------------|-------------------------|
| ZK1090-3xxx-xxxx     | EtherCAT cable M8, green         | <a href="#">Website</a> |
| ZK1093-3xxx-xxxx     | EtherCAT cable M8, yellow        | <a href="#">Website</a> |
| ZK2000-6xxx-xxxx     | Sensor cable M12, 4-pin          | <a href="#">Website</a> |
| ZK2000-7xxx-0xxx     | Sensor cable M12, 4-pin + shield | <a href="#">Website</a> |
| ZK2020-3xxx-xxxx     | Power cable M8, 4-pin            | <a href="#">Website</a> |

### Labeling material, protective caps

| Ordering information | Description                                     |
|----------------------|---|
| ZS5000-0010          | Protective cap for M8 sockets, IP67 (50 pieces) |
| ZS5000-0020          | Protective cap for M12 sockets, IP67 (50 pcs.)  |
| ZS5100-0000          | Inscription labels, unprinted, 4 strips of 10   |
| ZS5000-xxxx          | Printed inscription labels on enquiry           |

### Tools

| Ordering information | Description  |
|----------------------|--|
| ZB8801-0000          | Torque wrench for plugs, 0.4...1.0 Nm                                    |
| ZB8801-0001          | Torque cable key for M8 / wrench size 9 for ZB8801-0000                  |
| ZB8801-0002          | Torque cable key for M12 / wrench size 13 for ZB8801-0000                |
| ZB8801-0003          | Torque cable key for M12 field assembly / wrench size 18 for ZB8801-0000 |



#### Further accessories

Further accessories can be found in the price list for fieldbus components from Beckhoff and online at <https://www.beckhoff.com>.

## 6.3 Version identification of EtherCAT devices

### 6.3.1 General notes on marking

#### Designation

A Beckhoff EtherCAT device has a 14-digit designation, made up of

- family key
- type
- version
- revision

| Example          | Family   | Type                                   | Version                       | Revision |
|------------------|--|--|-------------------------------|----------|
| EL3314-0000-0016 | EL terminal<br>(12 mm, non-pluggable connection level) | 3314 (4-channel thermocouple terminal) | 0000 (basic type)             | 0016     |
| ES3602-0010-0017 | ES terminal<br>(12 mm, pluggable connection level)     | 3602 (2-channel voltage measurement)   | 0010 (high-precision version) | 0017     |
| CU2008-0000-0000 | CU device  | 2008 (8-port fast ethernet switch)     | 0000 (basic type)             | 0000     |

#### Notes

- The elements mentioned above result in the **technical designation**. EL3314-0000-0016 is used in the example below.
- EL3314-0000 is the order identifier, in the case of “-0000” usually abbreviated to EL3314. “-0016” is the EtherCAT revision.
- The **order identifier** is made up of
  - family key (EL, EP, CU, ES, KL, CX, etc.)
  - type (3314)
  - version (-0000)
- The **revision** -0016 shows the technical progress, such as the extension of features with regard to the EtherCAT communication, and is managed by Beckhoff.  
 In principle, a device with a higher revision can replace a device with a lower revision, unless specified otherwise, e.g. in the documentation.  
 Associated and synonymous with each revision there is usually a description (ESI, EtherCAT Slave Information) in the form of an XML file, which is available for download from the Beckhoff web site.  
 From 2014/01 the revision is shown on the outside of the IP20 terminals, see Fig. “EL5021 EL terminal, standard IP20 IO device with batch number and revision ID (since 2014/01)”.
- The type, version and revision are read as decimal numbers, even if they are technically saved in hexadecimal.

### 6.3.2 Version identification of EP/EPI/EPP/ER/ERI boxes

The serial number/ data code for Beckhoff IO devices is usually the 8-digit number printed on the device or on a sticker. The serial number indicates the configuration in delivery state and therefore refers to a whole production batch, without distinguishing the individual modules of a batch.

Structure of the serial number: **KK YY FF HH**

KK - week of production (CW, calendar week)

YY - year of production

FF - firmware version

HH - hardware version

Example with serial number 12 06 3A 02:

12 - production week 12

06 - production year 2006

3A - firmware version 3A

02 - hardware version 02

Exceptions can occur in the **IP67 area**, where the following syntax can be used (see respective device documentation):

Syntax: D ww yy x y z u

D - prefix designation

ww - calendar week

yy - year

x - firmware version of the bus PCB

y - hardware version of the bus PCB

z - firmware version of the I/O PCB

u - hardware version of the I/O PCB

Example: D.22081501 calendar week 22 of the year 2008 firmware version of bus PCB: 1 hardware version of bus PCB: 5 firmware version of I/O PCB: 0 (no firmware necessary for this PCB) hardware version of I/O PCB: 1

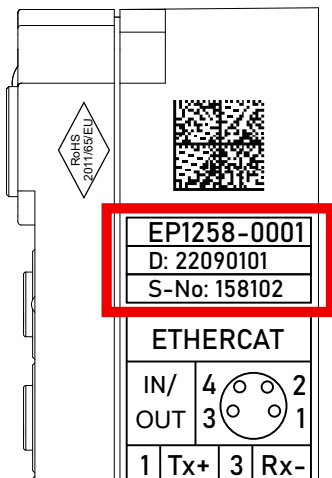

Fig. 14: EP1258-00001 IP67 EtherCAT Box with batch number/DateCode 22090101 and unique serial number 158102



### 6.3.3 Beckhoff Identification Code (BIC)

The Beckhoff Identification Code (BIC) is increasingly being applied to Beckhoff products to uniquely identify the product. The BIC is represented as a Data Matrix Code (DMC, code scheme ECC200), the content is based on the ANSI standard MH10.8.2-2016.

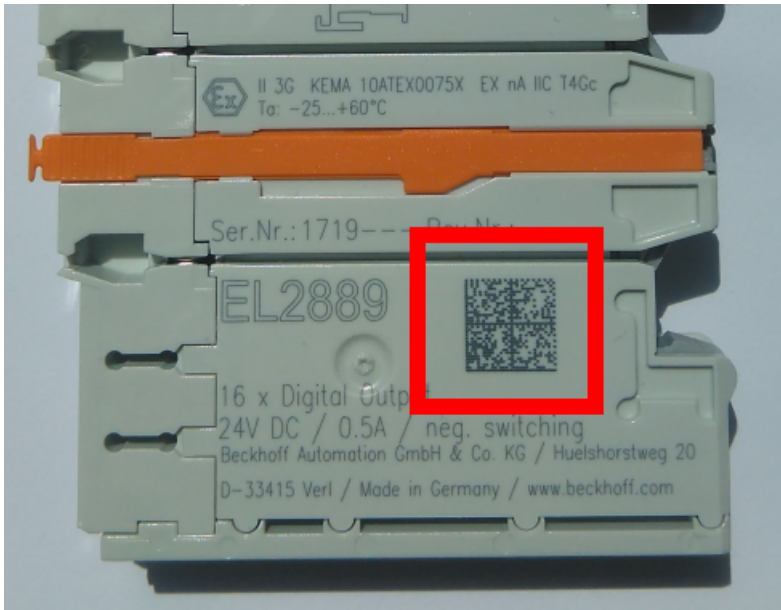

Fig. 15: BIC as data matrix code (DMC, code scheme ECC200)

The BIC will be introduced step by step across all product groups.

Depending on the product, it can be found in the following places:

- on the packaging unit
- directly on the product (if space suffices)
- on the packaging unit and the product

The BIC is machine-readable and contains information that can also be used by the customer for handling and product management.

Each piece of information can be uniquely identified using the so-called data identifier (ANSI MH10.8.2-2016). The data identifier is followed by a character string. Both together have a maximum length according to the table below. If the information is shorter, spaces are added to it.

Following information is possible, positions 1 to 4 are always present, the other according to need of production:

| Position | Type of information                | Explanation   | Data identifier | Number of digits incl. data identifier | Example                 |
|----------|------------------------------------|---|-----------------|--|-------------------------|
| 1        | Beckhoff order number              | <b>Beckhoff order number</b>  | 1P              | 8                                      | <b>1P</b> 072222        |
| 2        | Beckhoff Traceability Number (BTN) | <b>Unique serial number, see note below</b>                           | SBTN            | 12                                     | <b>S</b> BTNk4p562d7    |
| 3        | Article description                | <b>Beckhoff article description, e.g. EL1008</b>                      | 1K              | 32                                     | <b>1K</b> EL1809        |
| 4        | Quantity                           | <b>Quantity in packaging unit, e.g. 1, 10, etc.</b>                   | Q               | 6                                      | <b>Q</b> 1              |
| 5        | Batch number                       | Optional: Year and week of production                                 | 2P              | 14                                     | <b>2P</b> 401503180016  |
| 6        | ID/serial number                   | Optional: Present-day serial number system, e.g. with safety products | 51S             | 12                                     | <b>51S</b> 678294       |
| 7        | Variant number                     | Optional: Product variant number on the basis of standard products    | 30P             | 32                                     | <b>30P</b> F971, 2*K183 |
| ...      |                                    |   |                 |  |                         |

Further types of information and data identifiers are used by Beckhoff and serve internal processes.

### Structure of the BIC

Example of composite information from positions 1 to 4 and with the above given example value on position 6. The data identifiers are highlighted in bold font:

**1P**072222**S**BTNk4p562d7**1K**EL1809 **Q**1 **51S**678294

Accordingly as DMC:



Fig. 16: Example DMC **1P**072222**S**BTNk4p562d7**1K**EL1809 **Q**1 **51S**678294

### BTN

An important component of the BIC is the Beckhoff Traceability Number (BTN, position 2). The BTN is a unique serial number consisting of eight characters that will replace all other serial number systems at Beckhoff in the long term (e.g. batch designations on IO components, previous serial number range for safety products, etc.). The BTN will also be introduced step by step, so it may happen that the BTN is not yet coded in the BIC.

#### NOTE

This information has been carefully prepared. However, the procedure described is constantly being further developed. We reserve the right to revise and change procedures and documentation at any time and without prior notice. No claims for changes can be made from the information, illustrations and descriptions in this information.

### 6.3.4 Electronic access to the BIC (eBIC)

#### Electronic BIC (eBIC)

The Beckhoff Identification Code (BIC) is applied to the outside of Beckhoff products in a visible place. If possible, it should also be electronically readable.

Decisive for the electronic readout is the interface via which the product can be electronically addressed.

#### K-bus devices (IP20, IP67)

Currently, no electronic storage and readout is planned for these devices.

#### EtherCAT devices (IP20, IP67)

All Beckhoff EtherCAT devices have a so-called ESI-EEPROM, which contains the EtherCAT identity with the revision number. Stored in it is the EtherCAT slave information, also colloquially known as ESI/XML configuration file for the EtherCAT master. See the corresponding chapter in the EtherCAT system manual ([Link](#)) for the relationships.

The eBIC is also stored in the ESI-EEPROM. The eBIC was introduced into the Beckhoff I/O production (terminals, box modules) from 2020; widespread implementation is expected in 2021.

The user can electronically access the eBIC (if existent) as follows:

- With all EtherCAT devices, the EtherCAT master (TwinCAT) can read the eBIC from the ESI-EEPROM
  - From TwinCAT 3.1 build 4024.11, the eBIC can be displayed in the online view.
  - To do this, check the checkbox "Show Beckhoff Identification Code (BIC)" under EtherCAT → Advanced Settings → Diagnostics:

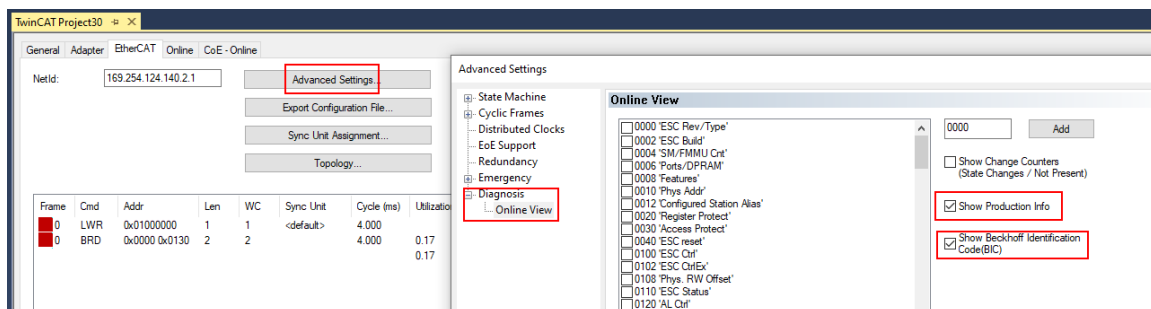

- The BTN and its contents are then displayed:

| No | Addr | Name            | State | CRC | Fw | Hw | Production Data | ItemNo | BTN      | Description | Quantity | BatchNo | SerialNo |
|----|------|-----------------|-------|-----|----|----|-----------------|--------|----------|-------------|----------|---------|----------|
| 1  | 1001 | Term 1 (EK1100) | OP    | 0,0 | 0  | 0  | ---             |        |          |             |          |         |          |
| 2  | 1002 | Term 2 (EL1018) | OP    | 0,0 | 0  | 0  | 2020 KW36 Fr    | 072222 | k4p562d7 | EL1809      | 1        |         | 678294   |
| 3  | 1003 | Term 3 (EL3204) | OP    | 0,0 | 7  | 6  | 2012 KW24 Sa    |        |          |             |          |         |          |
| 4  | 1004 | Term 4 (EL2004) | OP    | 0,0 | 0  | 0  | ---             | 072223 | k4p562d7 | EL2004      | 1        |         | 678295   |
| 5  | 1005 | Term 5 (EL1008) | OP    | 0,0 | 0  | 0  | ---             |        |          |             |          |         |          |
| 6  | 1006 | Term 6 (EL2008) | OP    | 0,0 | 0  | 12 | 2014 KW14 Mo    |        |          |             |          |         |          |
| 7  | 1007 | Term 7 (EK1110) | OP    | 0   | 1  | 8  | 2012 KW25 Mo    |        |          |             |          |         |          |

- Note: as can be seen in the illustration, the production data HW version, FW version and production date, which have been programmed since 2012, can also be displayed with "Show Production Info".
- From TwinCAT 3.1. build 4024.24 the functions *FB\_EcReadBIC* and *FB\_EcReadBTN* for reading into the PLC and further eBIC auxiliary functions are available in the Tc2\_EtherCAT Library from v3.3.19.0.
- In the case of EtherCAT devices with CoE directory, the object 0x10E2:01 can additionally be used to display the device's own eBIC; the PLC can also simply access the information here:

- The device must be in PREOP/SAFEOP/OP for access:

| Index   | Name                                      | Flags | Value   |
|---------|---|-------|---|
| 1000    | Device type                               | RO    | 0x015E1389 (22942601)                           |
| 1008    | Device name                               | RO    | ELM3704-0000                                    |
| 1009    | Hardware version                          | RO    | 00  |
| 100A    | Software version                          | RO    | 01  |
| 100B    | Bootloader version                        | RO    | J0.1.27.0                                       |
| 1011:0  | Restore default parameters                | RO    | > 1 <   |
| 1018:0  | Identity                                  | RO    | > 4 <   |
| 10E2:0  | Manufacturer-specific Identification C... | RO    | > 1 <   |
| 10E2:01 | SubIndex 001                              | RO    | 1P158442SBTN0008jekp1KELM3704 Q1 2P482001000016 |
| 10F0:0  | Backup parameter handling                 | RO    | > 1 <   |
| 10F3:0  | Diagnosis History                         | RO    | > 21 <  |
| 10F8    | Actual Time Stamp                         | RO    | 0x170bf277e                                     |

- the object 0x10E2 will be introduced into stock products in the course of a necessary firmware revision.
- From TwinCAT 3.1. build 4024.24 the functions *FB\_EcCoEReadBIC* and *FB\_EcCoEReadBTN* for reading into the PLC and further eBIC auxiliary functions are available in the *Tc2\_EtherCAT Library* from v3.3.19.0.
- Note: in the case of electronic further processing, the BTN is to be handled as a string(8); the identifier "SBTN" is not part of the BTN.
- Technical background  
The new BIC information is additionally written as a category in the ESI-EEPROM during the device production. The structure of the ESI content is largely dictated by the ETG specifications, therefore the additional vendor-specific content is stored with the help of a category according to ETG.2010. ID 03 indicates to all EtherCAT masters that they must not overwrite these data in case of an update or restore the data after an ESI update.  
The structure follows the content of the BIC, see there. This results in a memory requirement of approx. 50..200 bytes in the EEPROM.
- Special cases
  - If multiple, hierarchically arranged ESCs are installed in a device, only the top-level ESC carries the eBIC Information.
  - If multiple, non-hierarchically arranged ESCs are installed in a device, all ESCs carry the eBIC Information.
  - If the device consists of several sub-devices with their own identity, but only the top-level device is accessible via EtherCAT, the eBIC of the top-level device is located in the CoE object directory 0x10E2:01 and the eBICs of the sub-devices follow in 0x10E2:nn.

### Profibus/Profinet/DeviceNet... Devices

Currently, no electronic storage and readout is planned for these devices.

## 6.4 Support and Service

Beckhoff and their partners around the world offer comprehensive support and service, making available fast and competent assistance with all questions related to Beckhoff products and system solutions.

### Beckhoff's branch offices and representatives

Please contact your Beckhoff branch office or representative for local support and service on Beckhoff products!

The addresses of Beckhoff's branch offices and representatives round the world can be found on her internet pages: <https://www.beckhoff.com>

You will also find further documentation for Beckhoff components there.

### Beckhoff Support

Support offers you comprehensive technical assistance, helping you not only with the application of individual Beckhoff products, but also with other, wide-ranging services:

- support
- design, programming and commissioning of complex automation systems
- and extensive training program for Beckhoff system components

Hotline: +49 5246 963 157  
Fax: +49 5246 963 9157  
e-mail: [support@beckhoff.com](mailto:support@beckhoff.com)

### Beckhoff Service

The Beckhoff Service Center supports you in all matters of after-sales service:

- on-site service
- repair service
- spare parts service
- hotline service

Hotline: +49 5246 963 460  
Fax: +49 5246 963 479  
e-mail: [service@beckhoff.com](mailto:service@beckhoff.com)

### Beckhoff Headquarters

Beckhoff Automation GmbH & Co. KG

Huelshorstweg 20  
33415 Verl  
Germany

Phone: +49 5246 963 0  
Fax: +49 5246 963 198  
e-mail: [info@beckhoff.com](mailto:info@beckhoff.com)  
web: <https://www.beckhoff.com>



More Information:  
[www.beckhoff.com/ep2624-0002](http://www.beckhoff.com/ep2624-0002)

Beckhoff Automation GmbH & Co. KG  
Hülshorstweg 20  
33415 Verl  
Germany  
Phone: +49 5246 9630  
[info@beckhoff.com](mailto:info@beckhoff.com)  
[www.beckhoff.com](http://www.beckhoff.com)

