

Documentation | EN

# EP20xx and EP28xx

EtherCAT Box modules with digital outputs





# Table of contents

<b>1</b>	<b>Foreword</b> .....	<b>7</b>
1.1	Notes on the documentation .....	7
1.2	Safety instructions .....	8
1.3	Documentation issue status .....	9
<b>2</b>	<b>EtherCAT Box - Introduction</b> .....	<b>10</b>
<b>3</b>	<b>Product overview</b> .....	<b>12</b>
3.1	Module overview .....	12
3.2	EP2008-000x .....	13
3.2.1	EP2008-000x - Introduction .....	13
3.2.2	EP2008-000x - Technical data.....	15
3.2.3	EP2008-000x - Scope of supply.....	17
3.2.4	EP2008-000x - Process image .....	17
3.3	EP2008-0022 .....	18
3.3.1	EP2008-0022 - Introduction .....	18
3.3.2	EP2008-0022 - Technical data.....	19
3.3.3	EP2008-0022 - Scope of supply .....	20
3.3.4	EP2008-0022 – Process image .....	21
3.4	EP2028-000x .....	22
3.4.1	EP2028-000x - Introduction .....	22
3.4.2	EP2028-000x - Technical data.....	24
3.4.3	EP2028-000x - Scope of supply.....	25
3.4.4	EP2028-000x - Process image .....	26
3.5	EP2028-0032 .....	27
3.5.1	EP2028-0032 - Introduction .....	27
3.5.2	EP2028-0032 - Technical data.....	28
3.5.3	EP2028-0032 - Scope of supply .....	29
3.5.4	EP2028-0032 - Process image .....	30
3.6	EP2038-000x .....	31
3.6.1	EP2038-000x - Introduction .....	31
3.6.2	EP2038-000x - Technical data.....	33
3.6.3	EP2038-000x - Scope of supply.....	34
3.6.4	EP2038-000x - Status LEDs .....	35
3.6.5	EP2038-000x - Process image .....	36
3.7	EP2038-0042 .....	37
3.7.1	EP2038-0042 - Introduction .....	37
3.7.2	EP2038-0042 - Technical data.....	39
3.7.3	EP2038-0042 - Scope of supply .....	40
3.7.4	EP2038-0042 - Process image .....	41
3.8	EP2809-002x .....	43
3.8.1	EP2809-002x - Introduction .....	43
3.8.2	EP2809-002x - Technical data.....	45
3.8.3	EP2809-002x - Scope of supply.....	46
3.8.4	EP2809-002x - Process image .....	47
3.9	EP2809-0042 .....	48

3.9.1	EP2809-0042 - Introduction .....	48
3.9.2	EP2809-0042 - Technical data.....	49
3.9.3	EP2809-0042 - Scope of supply .....	50
3.9.4	EP2809-0042 - Process image .....	51
3.10	EP2816-00xx.....	52
3.10.1	EP2816-0003 - Introduction .....	52
3.10.2	EP2816-0004 - Introduction .....	53
3.10.3	EP2816-0008 - Introduction .....	54
3.10.4	EP2816-0010 - Introduction .....	55
3.10.5	EP2816-00xx - Technical data .....	56
3.10.6	EP2816-00xx - Scope of supply.....	57
3.10.7	EP2816-0004, EP2816-0008 - Status LEDs .....	58
3.10.8	EP2816-0010 - Status LEDs .....	59
3.10.9	EP2816-00xx - Process image.....	60
3.11	EP2817-0008 .....	64
3.11.1	EP2817-0008 - Introduction .....	64
3.11.2	EP2817-0008 - Technical data.....	65
3.11.3	EP2817-0008 - Scope of supply .....	66
3.11.4	EP2817-0008 - Status LEDs .....	67
3.11.5	EP2817-0008 - Process image .....	68
3.12	EP2839-0022 .....	72
3.12.1	EP2839-0022 - Introduction .....	72
3.12.2	EP2839-0022 - Technical data.....	73
3.12.3	EP2839-0022 - Scope of supply .....	74
3.12.4	EP2839-0022 - Process image .....	75
3.13	EP2839-0042 .....	77
3.13.1	EP2839-0042 - Introduction .....	77
3.13.2	EP2839-0042 - Technical data.....	79
3.13.3	EP2839-0042 - Scope of supply .....	80
3.13.4	EP2839-0042 - Process image .....	81
<b>4</b>	<b>Basic Function Principles .....</b>	<b>83</b>
4.1	Overload protection .....	83
<b>5</b>	<b>Mounting and connection.....</b>	<b>85</b>
5.1	Mounting .....	85
5.1.1	Dimensions EPxxxx-xx0x and EPxxxx-xx1x .....	85
5.1.2	Dimensions EPxxxx-xx2x.....	86
5.1.3	EPxxxx-xx32 dimensions .....	87
5.1.4	EPxxxx-xx42 dimensions .....	88
5.1.5	Fixing.....	89
5.1.6	Functional earth (FE) .....	90
5.2	Connections .....	91
5.2.1	Tightening torques for plug connectors.....	91
5.2.2	Protective caps.....	91
5.2.3	EtherCAT .....	92
5.2.4	Supply voltages.....	94

5.2.5	Digital outputs .....	98
5.3	UL Requirements .....	115
5.4	ATEX notes .....	116
5.4.1	ATEX - Special conditions.....	116
5.4.2	BG2000 - EtherCAT Box protection enclosures.....	117
5.4.3	ATEX Documentation.....	118
5.5	Disposal .....	119
<b>6</b>	<b>Commissioning and configuration .....</b>	<b>120</b>
6.1	Integrating into a TwinCAT project.....	120
6.2	Behavior of the outputs in case of a fault .....	121
6.2.1	Behavior on EtherCAT failure .....	121
6.2.2	Behavior in case of short circuit (EP281x only).....	124
6.2.3	Behavior in case of missing supply voltage (EP281x only).....	125
6.3	Enable additional diagnostic functions .....	126
6.4	Restore the delivery state .....	127
6.5	Decommissioning.....	128
<b>7</b>	<b>CoE parameters.....</b>	<b>129</b>
7.1	EP2038-0042 .....	129
7.1.1	Object overview.....	129
7.1.2	Object description and parameterization.....	135
7.2	EP2816-0008 .....	147
7.2.1	Object overview.....	147
7.2.2	Object description and parameterization.....	152
7.3	EP2817-0008 .....	162
7.3.1	Object overview.....	162
7.3.2	Object description and parameterization.....	168
7.4	EP2839-00x2 .....	182
7.4.1	Object overview.....	182
7.4.2	Object description and parameterization.....	190
<b>8</b>	<b>Appendix.....</b>	<b>209</b>
8.1	General operating conditions .....	209
8.2	Accessories .....	210
8.3	Version identification of EtherCAT devices .....	211
8.3.1	General notes on marking.....	211
8.3.2	Version identification of IP67 modules .....	212
8.3.3	Beckhoff Identification Code (BIC).....	213
8.3.4	Electronic access to the BIC (eBIC).....	215
8.4	Support and Service.....	217



# 1 Foreword

## 1.1 Notes on the documentation

### Intended audience

This description is only intended for the use of trained specialists in control and automation engineering who are familiar with the applicable national standards.

It is essential that the documentation and the following notes and explanations are followed when installing and commissioning these components.

The qualified personnel is obliged to always use the currently valid documentation.

The responsible staff must ensure that the application or use of the products described satisfy all the requirements for safety, including all the relevant laws, regulations, guidelines and standards.

### Disclaimer

The documentation has been prepared with care. The products described are, however, constantly under development.

We reserve the right to revise and change the documentation at any time and without prior announcement.

No claims for the modification of products that have already been supplied may be made on the basis of the data, diagrams and descriptions in this documentation.

### Trademarks

Beckhoff®, TwinCAT®, TwinCAT/BSD®, TC/BSD®, EtherCAT®, EtherCAT G®, EtherCAT G10®, EtherCAT P®, Safety over EtherCAT®, TwinSAFE®, XFC®, XTS® and XPlanar® are registered trademarks of and licensed by Beckhoff Automation GmbH. Other designations used in this publication may be trademarks whose use by third parties for their own purposes could violate the rights of the owners.

### Patent Pending

The EtherCAT Technology is covered, including but not limited to the following patent applications and patents: EP1590927, EP1789857, EP1456722, EP2137893, DE102015105702 with corresponding applications or registrations in various other countries.



EtherCAT® is registered trademark and patented technology, licensed by Beckhoff Automation GmbH, Germany.

### Copyright

© Beckhoff Automation GmbH & Co. KG, Germany.

The reproduction, distribution and utilization of this document as well as the communication of its contents to others without express authorization are prohibited.

Offenders will be held liable for the payment of damages. All rights reserved in the event of the grant of a patent, utility model or design.

## 1.2 Safety instructions

### Safety regulations

Please note the following safety instructions and explanations!  
Product-specific safety instructions can be found on following pages or in the areas mounting, wiring, commissioning etc.

### Exclusion of liability

All the components are supplied in particular hardware and software configurations appropriate for the application. Modifications to hardware or software configurations other than those described in the documentation are not permitted, and nullify the liability of Beckhoff Automation GmbH & Co. KG.

### Personnel qualification

This description is only intended for trained specialists in control, automation and drive engineering who are familiar with the applicable national standards.

### Signal words

The signal words used in the documentation are classified below. In order to prevent injury and damage to persons and property, read and follow the safety and warning notices.

### Personal injury warnings

**⚠ DANGER**

Hazard with high risk of death or serious injury.

**⚠ WARNING**

Hazard with medium risk of death or serious injury.

**⚠ CAUTION**

There is a low-risk hazard that could result in medium or minor injury.

### Warning of damage to property or environment

**NOTICE**

The environment, equipment, or data may be damaged.

### Information on handling the product



This information includes, for example:  
recommendations for action, assistance or further information on the product.



## 1.3 Documentation issue status

Version	Comment
3.10	<ul style="list-style-type: none"> <li>• “Connections” chapter updated</li> </ul>
3.9	<ul style="list-style-type: none"> <li>• Technical data updated</li> </ul>
3.8	<ul style="list-style-type: none"> <li>• EP2839-0022 added</li> <li>• EP2839-0042 added</li> <li>• Technical data updated</li> <li>• Product images updated</li> </ul>
3.7	<ul style="list-style-type: none"> <li>• Technical data updated</li> </ul>
3.6	<ul style="list-style-type: none"> <li>• EP2038-0042 added</li> <li>• Technical data updated</li> </ul>
3.5	<ul style="list-style-type: none"> <li>• Dimensions updated</li> <li>• UL requirements updated</li> </ul>
3.4	<ul style="list-style-type: none"> <li>• EP2028-0032: Information on freedom from interference added</li> <li>• Accessories updated</li> </ul>
3.3	<ul style="list-style-type: none"> <li>• Scope of delivery added</li> </ul>
3.2	<ul style="list-style-type: none"> <li>• EP2028-0032: Imprint updated</li> <li>• EP2817-0008: Connection updated</li> <li>• Status LEDs for the supply voltages updated</li> </ul>
3.1	<ul style="list-style-type: none"> <li>• EP2809-0042: Technical data and connections updated</li> </ul>
3.0	<ul style="list-style-type: none"> <li>• Documentation separated from EP2xxx 2.9.2</li> <li>• EP2809-0042 added</li> <li>• EP2816-0003 added</li> </ul>

### Firmware and hardware versions

This documentation refers to the firmware and hardware version that was applicable at the time the documentation was written.

The module features are continuously improved and developed further. Modules having earlier production statuses cannot have the same properties as modules with the latest status. However, existing properties are retained and are not changed, so that older modules can always be replaced with new ones.

The firmware and hardware version (delivery state) can be found in the batch number (D-number) printed on the side of the EtherCAT Box.

### Syntax of the batch number (D-number)

D: WW YY FF HH

WW - week of production (calendar week)

YY - year of production

FF - firmware version

HH - hardware version

Example with D no. 29 10 02 01:

29 - week of production 29

10 - year of production 2010

02 - firmware version 02

01 - hardware version 01

Further information on this topic: [Version identification of EtherCAT devices \[► 211\]](#).

## 2 EtherCAT Box - Introduction

The EtherCAT system has been extended with EtherCAT Box modules with protection class IP67. Through the integrated EtherCAT interface the modules can be connected directly to an EtherCAT network without an additional Coupler Box. The high-performance of EtherCAT is thus maintained into each module.

The extremely low dimensions of only 126 x 30 x 26.5 mm (h x w x d) are identical to those of the Fieldbus Box extension modules. They are thus particularly suitable for use where space is at a premium. The small mass of the EtherCAT modules facilitates applications with mobile I/O interface (e.g. on a robot arm). The EtherCAT connection is established via screened M8 connectors.

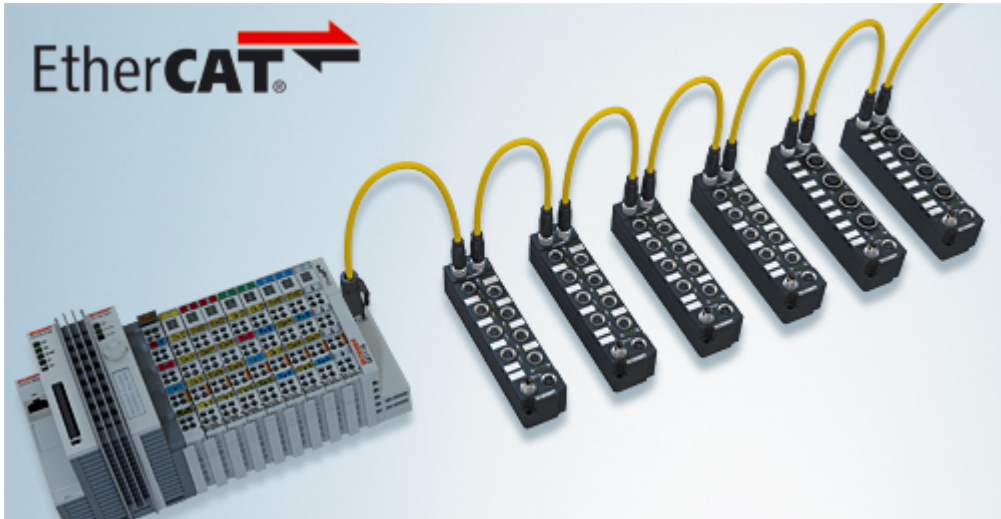

Fig. 1: EtherCAT Box Modules within an EtherCAT network

The robust design of the EtherCAT Box modules enables them to be used directly at the machine. Control cabinets and terminal boxes are now no longer required. The modules are fully sealed and therefore ideally prepared for wet, dirty or dusty conditions.

Pre-assembled cables significantly simplify EtherCAT and signal wiring. Very few wiring errors are made, so that commissioning is optimized. In addition to pre-assembled EtherCAT, power and sensor cables, field-configurable connectors and cables are available for maximum flexibility. Depending on the application, the sensors and actuators are connected through M8 or M12 connectors.

The EtherCAT modules cover the typical range of requirements for I/O signals with protection class IP67:

- digital inputs with different filters (3.0 ms or 10  $\mu$ s)
- digital outputs with 0.5 or 2 A output current
- analog inputs and outputs with 16 bit resolution
- Thermocouple and RTD inputs
- Stepper motor modules

XFC (eXtreme Fast Control Technology) modules, including inputs with time stamp, are also available.



Fig. 2: EtherCAT Box with M8 connections for sensors/actuators



Fig. 3: EtherCAT Box with M12 connections for sensors/actuators

---

**● Basic EtherCAT documentation**

**i** You will find a detailed description of the EtherCAT system in the Basic System Documentation for EtherCAT, which is available for download from our website ([www.beckhoff.com](http://www.beckhoff.com)) under Downloads.

---

## 3 Product overview

### 3.1 Module overview

The following table shows the products described in this documentation and the main distinguishing features.

Module	Signal connection	Number of outputs	Output current		Special features
			per output	Sum	
<a href="#">EP2008-0001 [▶ 13]</a>	8x M8	8	0.5 A	4 A	-
<a href="#">EP2008-0002 [▶ 13]</a>	4x M12	8	0.5 A	4 A	-
<a href="#">EP2008-0022 [▶ 18]</a>	8x M12	8	0.5 A	4 A	-
<a href="#">EP2028-0001 [▶ 22]</a>	8x M8	8	2.0 A	4 A	-
<a href="#">EP2028-0002 [▶ 22]</a>	4x M12	8	2.0 A	4 A	-
<a href="#">EP2028-0032 [▶ 27]</a>	8x M12	8	2.8 A	16 A	-
<a href="#">EP2038-0001 [▶ 31]</a>	8x M8	8	2.0 A	4 A	Diagnosis
<a href="#">EP2038-0002 [▶ 31]</a>	4x M12	8	2.0 A	4 A	Diagnosis
<a href="#">EP2038-0042 [▶ 37]</a>	8x M12	8	2.4 A	16 A	Diagnosis
<a href="#">EP2809-0021 [▶ 43]</a>	16x M8	16	0.5 A	4 A	-
<a href="#">EP2809-0022 [▶ 43]</a>	8x M12	16	0.5 A	4 A	-
<a href="#">EP2809-0042 [▶ 48]</a>	8x M12	16	0.5 A	8 A	-
<a href="#">EP2816-0003 [▶ 52]</a>	2x ZS2001	16	0.5 A	4 A	Diagnosis
<a href="#">EP2816-0004 [▶ 53]</a>	1x M16, 19-pin	16	0.5 A	4 A	Diagnosis
<a href="#">EP2816-0008 [▶ 54]</a>	1x D-sub 25	16	0.5 A	4 A	Diagnosis
<a href="#">EP2816-0010 [▶ 55]</a>	2x D-sub 8	16	0.5 A	4 A	Diagnosis
<a href="#">EP2817-0008 [▶ 64]</a>	1x D-sub 25	24	0.5 A	4 A	Diagnosis
<a href="#">EP2839-0022 [▶ 72]</a>	8x M12	16	0.5 A	4 A	Diagnosis
<a href="#">EP2839-0042 [▶ 77]</a>	8x M12	16	0.5 A	16 A	Diagnosis

### 3.2 EP2008-000x

#### 3.2.1 EP2008-000x - Introduction

##### EP2008-0001

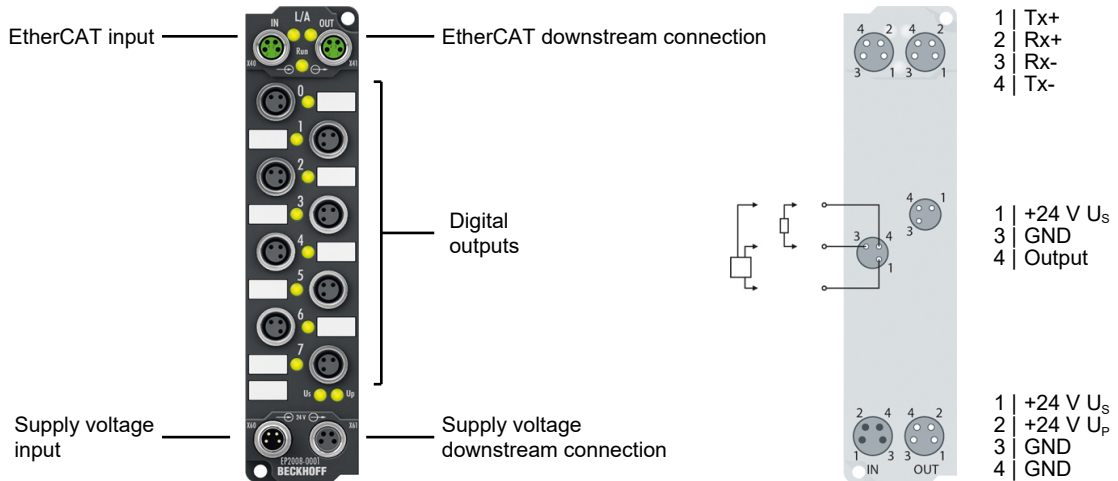

##### EP2008-0002

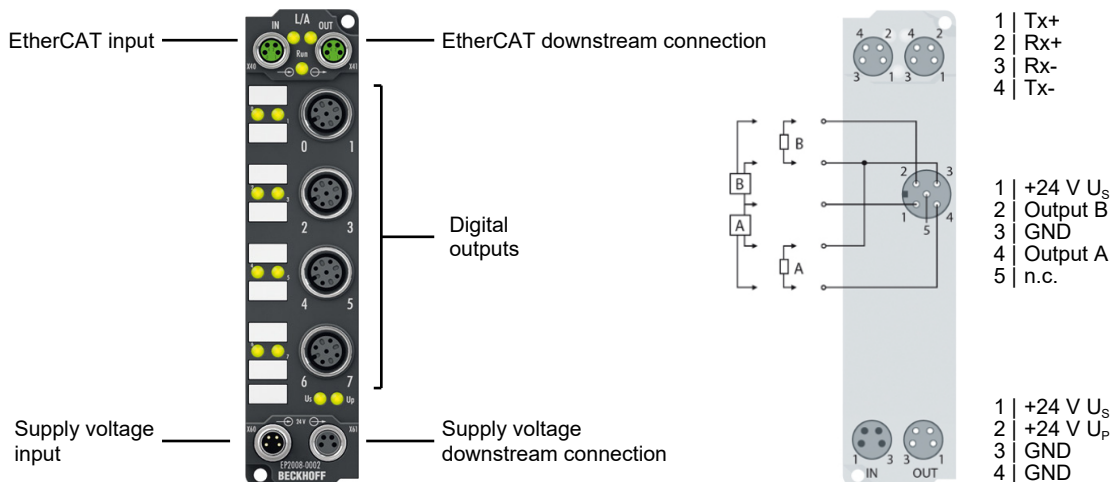

#### 8-channel digital output, 24 V<sub>DC</sub>, 0.5 A

The EP2008-000x EtherCAT Box is designed for processing digital/binary signals. It connects the binary control signals from the automation device on to the actuators at the process level. The outputs handle an output current of up to max. 0.5 A. A short-term overload is possible. The outputs are short-circuit proof. The sum current of all outputs is limited to 4 A.

The signal state of the channels is indicated by LEDs. The signal connection is established via screw-type M8 (EP2008-0001) or M12 (EP2008-0002) connectors.

**Quick links**

[Technical data \[▶ 15\]](#)

[Process image \[▶ 17\]](#)

[Dimensions \[▶ 85\]](#)

[EP2008-0001 Actuator connection \[▶ 98\]](#)

[EP2008-0002 Actuator connection \[▶ 99\]](#)

### 3.2.2 EP2008-000x - Technical data

All values are typical values over the entire temperature range, unless stated otherwise.

EtherCAT	
Connection	2 x M8 socket, 4-pin, A-coded, shielded
Electrical isolation	500 V

Supply voltages	
Connection	Input: M8 connector, 4-pin, A-coded Downstream connection: M8 socket, 4-pin, A-coded
$U_S$ nominal voltage	24 V <sub>DC</sub> (-15 % / +20 %)
$U_S$ sum current: $I_{S,sum}$	max. 4 A
Current consumption from $U_S$	120 mA
Rated voltage $U_P$	24 V <sub>DC</sub> (-15 % / +20 %)
$U_P$ sum current: $I_{P,sum}$	max. 4 A
Current consumption from $U_P$	20 mA + load
Electrical isolation GND <sub>S</sub> / GND <sub>P</sub>	no

Digital outputs	EP2008-0001	EP2008-0002
Number	8	
Connection	8 x M8 socket, 3-pin, A-coded	4 x M12 socket, 5-pin, A-coded
Load type	ohmic, inductive, lamp load	
Nominal output voltage	24 V <sub>DC</sub> from $U_P$	
Output current	max. 0.5 A per channel	
Short-circuit current	1.5 A typ.	
Changeover times	$T_{ON}$ : 50 $\mu$ s typ., $T_{OFF}$ : 100 $\mu$ s typ.	
Auxiliary voltage output	24 V <sub>DC</sub> from $U_S$ , max. 0.5 A in total, short-circuit proof	

Housing data	
Dimensions W x H x D	30 mm x 126 mm x 26.5 mm (without connectors)
Weight	approx. 165 g
Installation position	variable
Material	PA6 (polyamide)

Environmental conditions	
Ambient temperature during operation	-25 ... +60 °C -25 ... +55 °C according to cURus 0 ... +55 °C according to ATEX
Ambient temperature during storage	-40 ... +85 °C
Vibration resistance, shock resistance	conforms to EN 60068-2-6 / EN 60068-2-27 Additional tests [► 16]
EMC immunity / emission	conforms to EN 61000-6-2 / EN 61000-6-4
Protection rating	IP65, IP66, IP67 (according to EN 60529)

Approvals / markings	
Approvals / markings *)	ATEX [► 116], CE, cURus [► 115]

\*) Real applicable approvals/markings see type plate on the side (product marking).

**Additional tests**

The devices have undergone the following additional tests:

<b>Test</b>	<b>Explanation</b>
Vibration	10 frequency sweeps in 3 axes
	5 Hz < f < 60 Hz displacement 0.35 mm, constant amplitude
	60.1 Hz < f < 500 Hz acceleration 5 g, constant amplitude
Shocks	1000 shocks in each direction, in 3 axes
	35 g, 11 ms



### 3.2.3 EP2008-000x - Scope of supply

Make sure that the following components are included in the scope of delivery:

- 1x EtherCAT Box EP2008-000x
- 2x protective cap for EtherCAT socket, M8, green (pre-assembled)
- 1x protective cap for supply voltage input, M8, transparent (pre-assembled)
- 1x protective cap for supply voltage output, M8, black (pre-assembled)
- 10x labels, blank (1 strip of 10)

---

**● Pre-assembled protective caps do not ensure IP67 protection**

**i** Protective caps are pre-assembled at the factory to protect connectors during transport. They may not be tight enough to ensure IP67 protection.

Ensure that the protective caps are correctly seated to ensure IP67 protection.

---

### 3.2.4 EP2008-000x - Process image

#### Channel 1 to Channel 8

Under **Channel 1** to **Channel 8** you will find the 8 digital outputs of the module (here as an example the EP2008-0001).

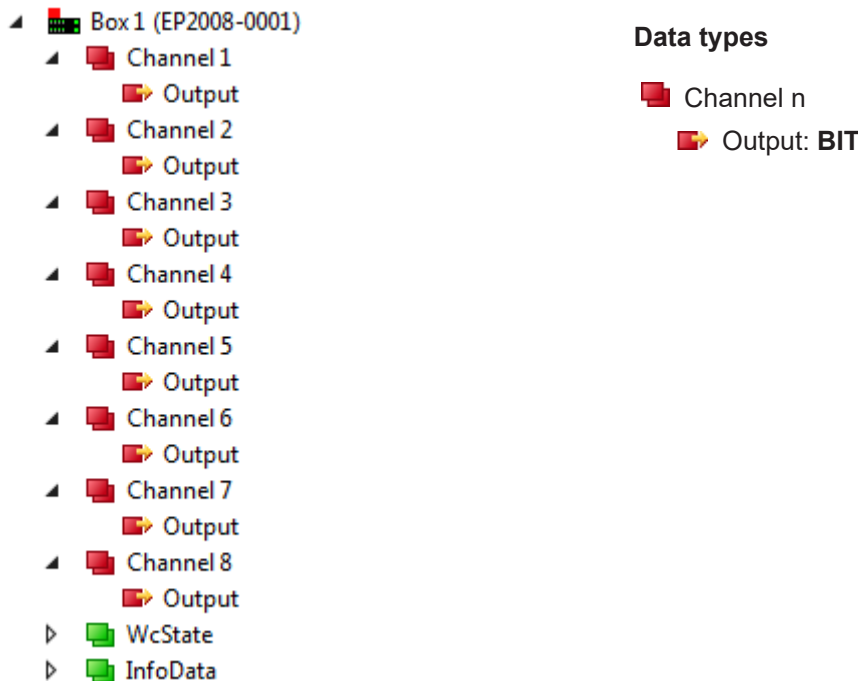

### 3.3 EP2008-0022

#### 3.3.1 EP2008-0022 - Introduction

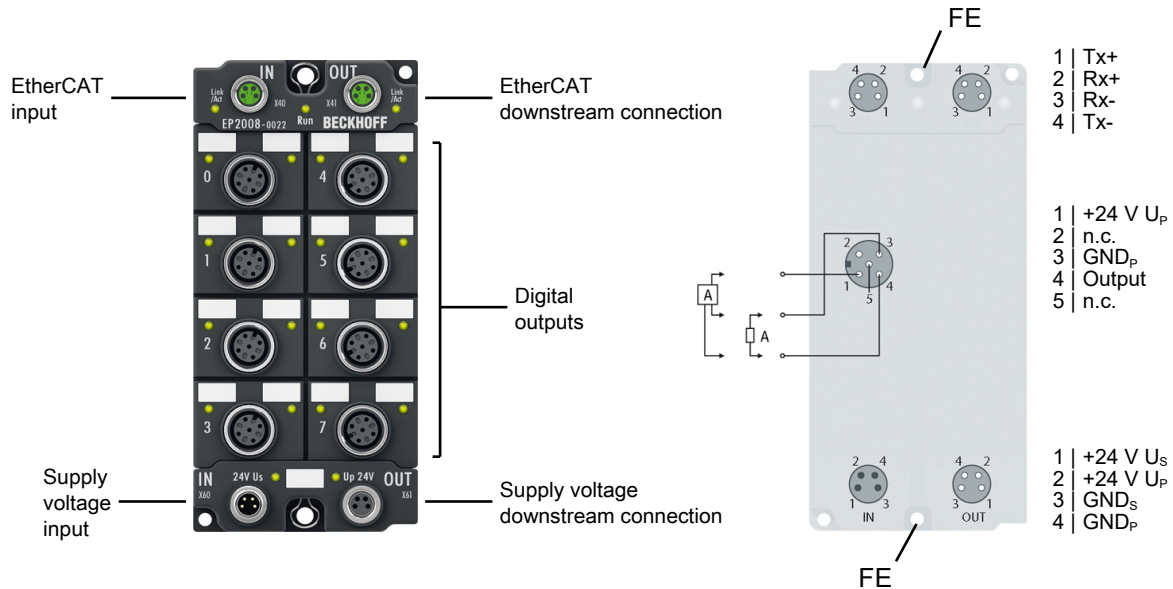

#### 8-channel digital output, 24 V<sub>DC</sub>, 0.5 A

The EP2008-0022 EtherCAT Box is designed for processing digital/binary signals. It connects the binary control signals from the automation device on to the actuators at the process level. The outputs handle an output current of up to max. 0.5 A. A short-term overload is possible. The outputs are short-circuit proof. The sum current of all outputs is limited to 4 A.

The signal state of the channels is indicated by LEDs. The signal connection is established via screw-type M12 connectors. One channel is available per M12 socket.

#### Quick links

[Technical data](#) [▶ 19]

[Process image](#) [▶ 21]

[Dimensions](#) [▶ 86]

[Actuator connection](#) [▶ 101]

### 3.3.2 EP2008-0022 - Technical data

All values are typical values over the entire temperature range, unless stated otherwise.

<b>EtherCAT</b>	
Connection	2 x M8 socket, 4-pin, A-coded, shielded
Electrical isolation	500 V

<b>Supply voltages</b>	
Connection	Input: M8 connector, 4-pin, A-coded Downstream connection: M8 socket, 4-pin, A-coded
$U_S$ nominal voltage	24 V <sub>DC</sub> (-15 % / +20 %)
$U_S$ sum current: $I_{S,sum}$	max. 4 A
Current consumption from $U_S$	130 mA
Rated voltage $U_P$	24 V <sub>DC</sub> (-15 % / +20 %)
$U_P$ sum current: $I_{P,sum}$	max. 4 A
Current consumption from $U_P$	20 mA + load
Electrical isolation GND <sub>S</sub> / GND <sub>P</sub>	yes

<b>Digital outputs</b>	
Number	8
Connection	8 x M12 socket, 5-pin, A-coded
Load type	ohmic, inductive, lamp load
Nominal output voltage	24 V <sub>DC</sub> from $U_P$
Output current	max. 0.5 A per channel
Short-circuit current	1.5 A typ.
Output driver supply	from $U_P$
Changeover times	$T_{ON}$ : 60 µs typ., $T_{OFF}$ : 300 µs typ.
Auxiliary voltage output	24 V <sub>DC</sub> from $U_P$ max. 0.5 A in total, short-circuit proof in total

<b>Housing data</b>	
Dimensions W x H x D	60 mm x 126 mm x 26.5 mm (without plug connectors)
Weight	approx. 250 g
Installation position	variable
Material	PA6 (polyamide)

<b>Environmental conditions</b>	
Ambient temperature during operation	-25 ... +60 °C -25 ... +55 °C according to cURus
Ambient temperature during storage	-40 ... +85 °C
Vibration resistance, shock resistance	conforms to EN 60068-2-6 / EN 60068-2-27 Additional tests [► 20]
EMC immunity / emission	conforms to EN 61000-6-2 / EN 61000-6-4
Protection class	IP65, IP66, IP67 (conforms to EN 60529)

<b>Approvals/markings</b>	
Approvals/markings *)	CE, cURus [► 115]

\*) Real applicable approvals/markings see type plate on the side (product marking).

### Additional tests

The devices have undergone the following additional tests:

Test	Explanation
Vibration	10 frequency sweeps in 3 axes
	5 Hz < f < 60 Hz displacement 0.35 mm, constant amplitude
	60.1 Hz < f < 500 Hz acceleration 5 g, constant amplitude
Shocks	1000 shocks in each direction, in 3 axes
	35 g, 11 ms

### 3.3.3 EP2008-0022 - Scope of supply

Make sure that the following components are included in the scope of delivery:

- 1x EtherCAT Box EP2008-0022
- 2x protective cap for EtherCAT socket, M8, green (pre-assembled)
- 1x protective cap for supply voltage input, M8, transparent (pre-assembled)
- 1x protective cap for supply voltage output, M8, black (pre-assembled)
- 10x labels, blank (1 strip of 10)

---

#### **● Pre-assembled protective caps do not ensure IP67 protection**

**i** Protective caps are pre-assembled at the factory to protect connectors during transport. They may not be tight enough to ensure IP67 protection.



















Ensure that the protective caps are correctly seated to ensure IP67 protection.

---

### 3.3.4 EP2008-0022 – Process image

#### Channel 1 to Channel 8

Under Channel 1 to Channel 8 you will find the digital outputs of the module.

- ▲  Box 1 (EP2008-0022)
  - ▲  Channel 1
    - ▶  Output
  - ▲  Channel 2
    - ▶  Output
  - ▲  Channel 3
    - ▶  Output
  - ▲  Channel 4
    - ▶  Output
  - ▲  Channel 5
    - ▶  Output
  - ▲  Channel 6
    - ▶  Output
  - ▲  Channel 7
    - ▶  Output
  - ▲  Channel 8
    - ▶  Output
  - ▶  WcState
  - ▶  InfoData

#### Data types

-  Channel n
  - ▶  Output: **BIT**

### 3.4 EP2028-000x

#### 3.4.1 EP2028-000x - Introduction

##### EP2008-0001

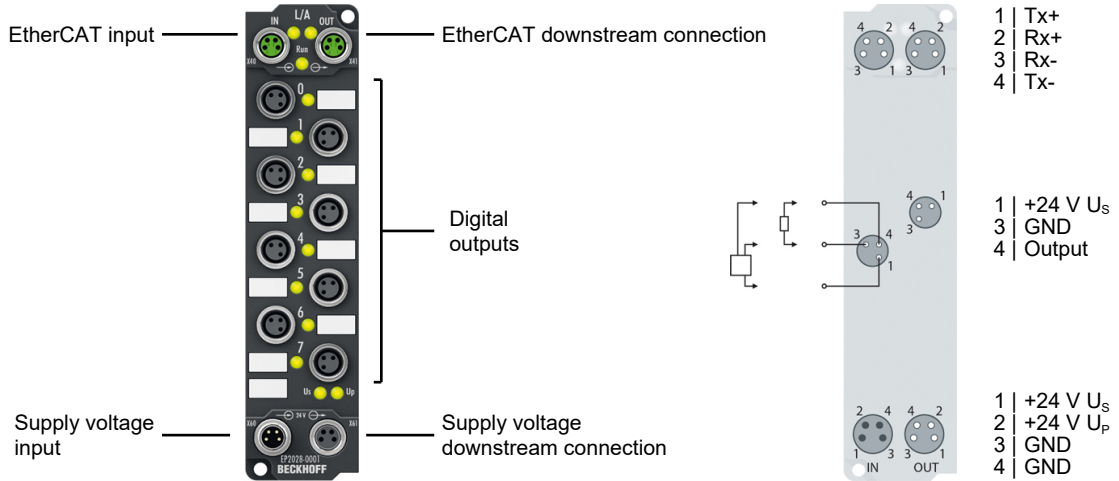

##### EP2028-0002

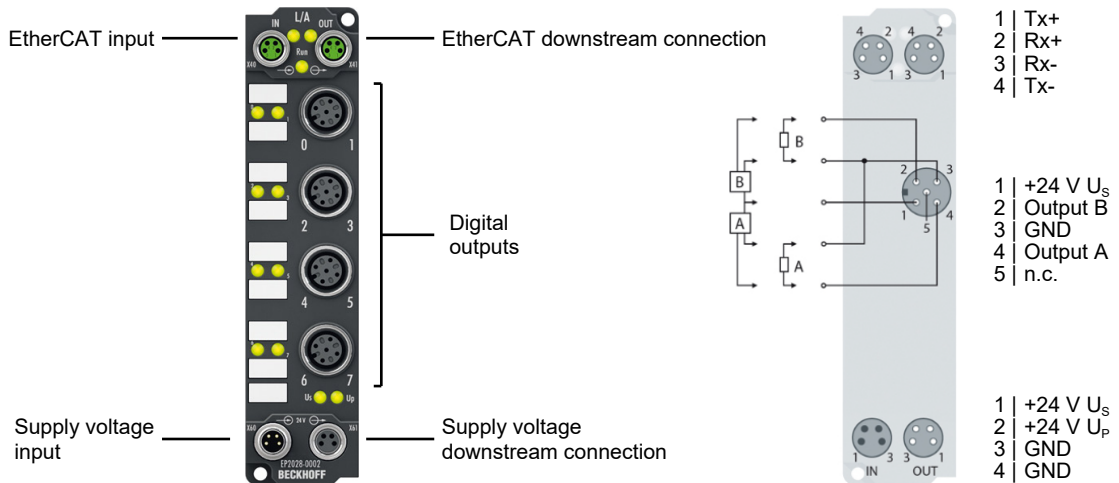

#### 8-channel digital output, 24 V<sub>DC</sub>, 2 A

The EP2028-000x EtherCAT Box is designed for processing digital/binary signals. It connects the binary control signals from the automation device on to the actuators at the process level. The outputs handle an output current of up to max. 2.0 A. A short-term overload is possible. The outputs are short-circuit proof. The sum current of all outputs is limited to 4 A.

The signal state of the channels is indicated by LEDs. The signal connection is established via screw-type M8 (EP2028-0001) or M12 (EP2028-0002) connectors.

**Quick links**

[Technical data \[▶ 24\]](#)

[Process image \[▶ 26\]](#)

[Dimensions \[▶ 85\]](#)

[EP2028-0001 Actuator connection \[▶ 98\]](#)

[EP2028-0002 Actuator connection \[▶ 99\]](#)

### 3.4.2 EP2028-000x - Technical data

All values are typical values over the entire temperature range, unless stated otherwise.

EtherCAT	
Connection	2 x M8 socket, 4-pin, A-coded, shielded
Electrical isolation	500 V

Supply voltages	
Connection	Input: M8 connector, 4-pin, A-coded Downstream connection: M8 socket, 4-pin, A-coded
$U_S$ nominal voltage	24 V <sub>DC</sub> (-15 % / +20 %)
$U_S$ sum current: $I_{S,sum}$	max. 4 A
Current consumption from $U_S$	120 mA
Rated voltage $U_P$	24 V <sub>DC</sub> (-15 % / +20 %)
$U_P$ sum current: $I_{P,sum}$	max. 4 A
Current consumption from $U_P$	20 mA + load
Electrical isolation GND <sub>S</sub> / GND <sub>P</sub>	no

Digital outputs	EP2028-0001	EP2028-0002
Number	8	
Connection	8 x M8 socket, 3-pin, A-coded	4 x M12 socket, 5-pin, A-coded
Load type	ohmic, inductive, lamp load	
Nominal output voltage	24 V <sub>DC</sub> from $U_P$	
Output current	max. 2.0 A per channel Sum current of all outputs max. 4.0 A	
Short-circuit current	15 A typ.	
Output driver supply	from $U_P$	
Changeover times	$T_{ON}$ : 200 $\mu$ s typ., $T_{OFF}$ : 200 $\mu$ s typ.	
Auxiliary voltage output	24 V <sub>DC</sub> from $U_S$ max. 0.5 A in total, short-circuit proof in total	

Housing data	
Dimensions W x H x D	30 mm x 126 mm x 26.5 mm (without connectors)
Weight	approx. 165 g
Installation position	variable
Material	PA6 (polyamide)

Environmental conditions	
Ambient temperature during operation	-25 ... +60 °C -25 ... +55 °C according to cURus 0 ... +55 °C according to ATEX
Ambient temperature during storage	-40 ... +85 °C
Vibration resistance, shock resistance	conforms to EN 60068-2-6 / EN 60068-2-27 Additional tests [► 25]
EMC immunity / emission	conforms to EN 61000-6-2 / EN 61000-6-4
Protection rating	IP65, IP66, IP67 (according to EN 60529)

Approvals / markings	
Approvals / markings *)	ATEX [► 116], CE, cURus [► 115]



\*) Real applicable approvals/markings see type plate on the side (product marking).

**Additional tests**

The devices have undergone the following additional tests:

Test	Explanation
Vibration	10 frequency sweeps in 3 axes
	5 Hz < f < 60 Hz displacement 0.35 mm, constant amplitude
	60.1 Hz < f < 500 Hz acceleration 5 g, constant amplitude
Shocks	1000 shocks in each direction, in 3 axes
	35 g, 11 ms

**3.4.3 EP2028-000x - Scope of supply**

Make sure that the following components are included in the scope of delivery:

- 1x EtherCAT Box EP2028-000x
- 2x protective cap for EtherCAT socket, M8, green (pre-assembled)
- 1x protective cap for supply voltage input, M8, transparent (pre-assembled)
- 1x protective cap for supply voltage output, M8, black (pre-assembled)
- 10x labels, blank (1 strip of 10)

---

**i** **Pre-assembled protective caps do not ensure IP67 protection**  
 Protective caps are pre-assembled at the factory to protect connectors during transport. They may not be tight enough to ensure IP67 protection.



















Ensure that the protective caps are correctly seated to ensure IP67 protection.

---



### 3.4.4 EP2028-000x - Process image

#### Channel 1 to Channel 8

Under **Channel 1** to **Channel 8** you will find the 8 digital outputs of the module (here as an example the EP2028-0001).

- ▲  Box 2 (EP2028-0001)
  - ▲  Channel 1
    - ▶  Output
  - ▲  Channel 2
    - ▶  Output
  - ▲  Channel 3
    - ▶  Output
  - ▲  Channel 4
    - ▶  Output
  - ▲  Channel 5
    - ▶  Output
  - ▲  Channel 6
    - ▶  Output
  - ▲  Channel 7
    - ▶  Output
  - ▲  Channel 8
    - ▶  Output
  - ▶  WcState
  - ▶  InfoData

#### Data types

-  Channel n
  - ▶  Output: **BIT**

### 3.5 EP2028-0032

#### 3.5.1 EP2028-0032 - Introduction

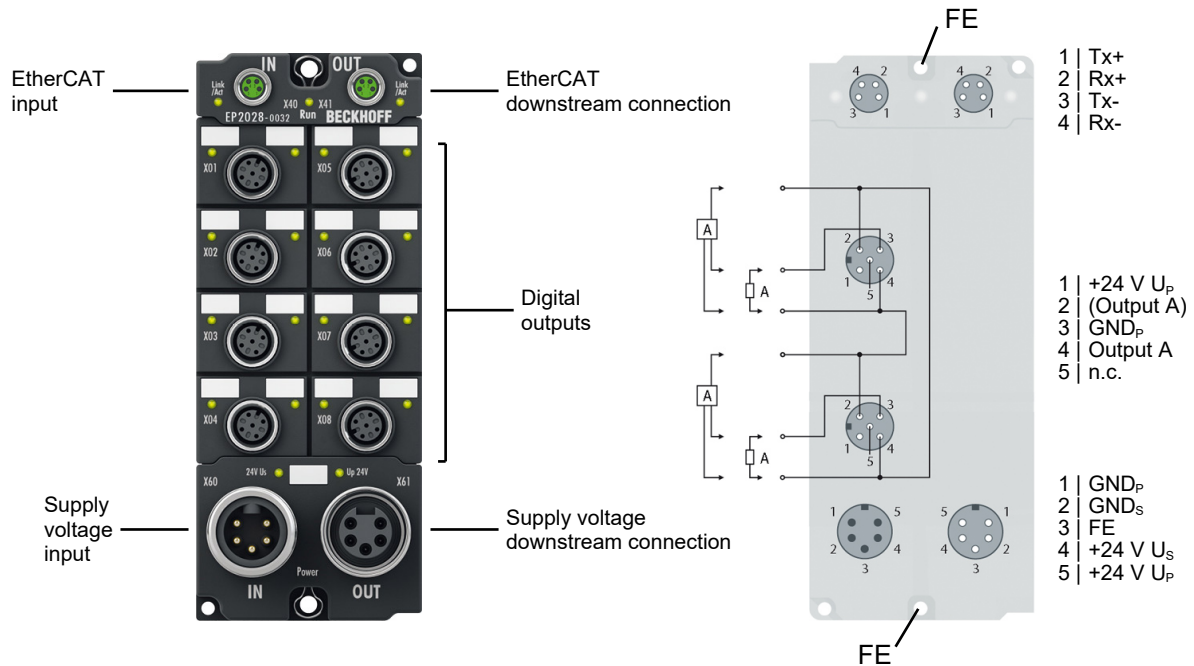

#### 8-channel digital output, 24 V<sub>DC</sub>, 2.8 A

The EP2028-0032 EtherCAT Box is designed for processing digital/binary signals. It connects the binary control signals from the automation device on to the actuators at the process level. The outputs handle an output current of up to max. 2.8 A. A short-term overload is possible. The outputs are short-circuit proof. The sum current of all outputs is limited to 16 A. 7/8" connectors are used to feed in and feed out the supply voltage.

The signal state of the channels is indicated by LEDs. The signal connection is established via screw-type M12 connectors. One channel is available per M12 socket.

Two digital outputs are available on each M12 socket. The same two digital outputs are also available on an adjacent M12 socket. This enables different connection variants, see chapter [M12 sockets of EP2028-0032](#) [► 102]:

- A separate connection cable for each actuator
- One common connection cable for two actuators

The EP2028-0032 is interference-free. You can use the EP2028-0032 instead of an interference-free standard terminal in accordance with the following chapters of the [TwinSAFE Application Guide](#):

- "All-pole disconnection of a potential group with downstream interference-free standard terminals (Category 4, PL e)"
- "Single-pole disconnection of a potential group with downstream interference-free standard terminals with fault exclusion (Category 4, PL e)"
- „EL2911 potential group with interference-free standard terminals (Category 4, PL e)"

#### Quick links

- [Technical data](#) [► 28]
- [Process image](#) [► 30]
- [Dimensions](#) [► 87]
- [Actuator connection](#) [► 102]

### 3.5.2 EP2028-0032 - Technical data

All values are typical values over the entire temperature range, unless stated otherwise.

EtherCAT	
Connection	2 x M8 socket, 4-pin, A-coded, shielded
Electrical isolation	500 V

Supply voltages	
Connection	Input: 7/8" plug, 5-pin, 16-UN thread Downstream connection: 7/8" socket, 5-pin, 16-UN thread
U <sub>S</sub> nominal voltage	24 V <sub>DC</sub> (-15 % / +20 %)
U <sub>S</sub> sum current	max. 16 A at 40 °C
Current consumption from U <sub>S</sub>	130 mA
Rated voltage U <sub>P</sub>	24 V <sub>DC</sub> (-15 % / +20 %)
U <sub>P</sub> sum current	max. 16 A at 40 °C
Current consumption from U <sub>P</sub>	20 mA + load
Electrical isolation GND <sub>S</sub> / GND <sub>P</sub>	yes

Digital outputs	
Number	8
Connection	8 x M12 socket, 5-pin, A-coded
Load type	ohmic, inductive, lamp load
Nominal output voltage	24 V <sub>DC</sub> from U <sub>P</sub>
Output current	max. 2.8 A per channel sum current of all outputs max. 16 A at 40 °C
Short-circuit current	15 A typ.
Output driver supply	from U <sub>P</sub>
Changeover times	T <sub>ON</sub> : 200 µs typ., T <sub>OFF</sub> : 200 µs typ.
Auxiliary voltage output	24 V <sub>DC</sub> from U <sub>P</sub> max. 0.5 A in total, short-circuit proof in total

Housing data	
Dimensions W x H x D	60 mm x 150 mm x 26,5 mm (without connectors)
Weight	approx. 440 g
Installation position	variable
Material	PA6 (polyamide)

Environmental conditions	
Ambient temperature during operation	-25 ... +60 °C
Ambient temperature during storage	-40 ... +85 °C
Vibration / shock resistance	conforms to EN 60068-2-6 / EN 60068-2-27
EMC immunity / emission	conforms to EN 61000-6-2 / EN 61000-6-4
Protection class	IP65, IP66, IP67 conforms to EN 60529

Approvals / markings	
Approvals / markings *)	CE, UL under preparation

\*) Real applicable approvals/markings see type plate on the side (product marking).

**Additional tests**

The devices have undergone the following additional tests:

Test	Explanation
Vibration	10 frequency sweeps in 3 axes
	5 Hz < f < 60 Hz displacement 0.35 mm, constant amplitude
	60.1 Hz < f < 500 Hz acceleration 5 g, constant amplitude
Shocks	1000 shocks in each direction, in 3 axes
	35 g, 11 ms

**3.5.3 EP2028-0032 - Scope of supply**

Make sure that the following components are included in the scope of delivery:

- 1x EtherCAT Box EP2028-0032
- 2x protective cap for EtherCAT socket, M8, green (pre-assembled)
- 1x Protective cap for supply voltage output, 7/8", black (pre-fitted)
- 10x labels, blank (1 strip of 10)

---

**i Pre-assembled protective caps do not ensure IP67 protection**

Protective caps are pre-assembled at the factory to protect connectors during transport. They may not be tight enough to ensure IP67 protection.



















Ensure that the protective caps are correctly seated to ensure IP67 protection.

---



### 3.5.4 EP2028-0032 - Process image

#### Channel 1 to Channel 8

Under **Channel 1** to **Channel 8** you will find the 8 digital outputs of the module (here as an example the EP2028-0001).

- ▲  Box 1 (EP2028-0032)
  - ▲  Channel 1
    - ▶  Output
  - ▲  Channel 2
    - ▶  Output
  - ▲  Channel 3
    - ▶  Output
  - ▲  Channel 4
    - ▶  Output
  - ▲  Channel 5
    - ▶  Output
  - ▲  Channel 6
    - ▶  Output
  - ▲  Channel 7
    - ▶  Output
  - ▲  Channel 8
    - ▶  Output
  - ▶  WcState
  - ▶  InfoData

#### Data types

-  Channel n
  - ▶  Output: **BIT**

### 3.6 EP2038-000x

#### 3.6.1 EP2038-000x - Introduction

##### EP2038-0001

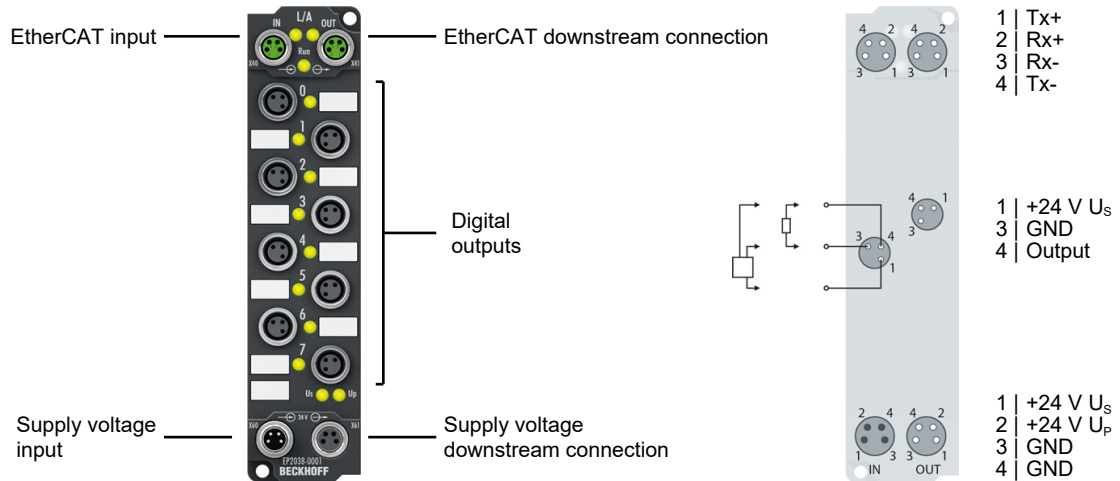

##### EP2038-0002

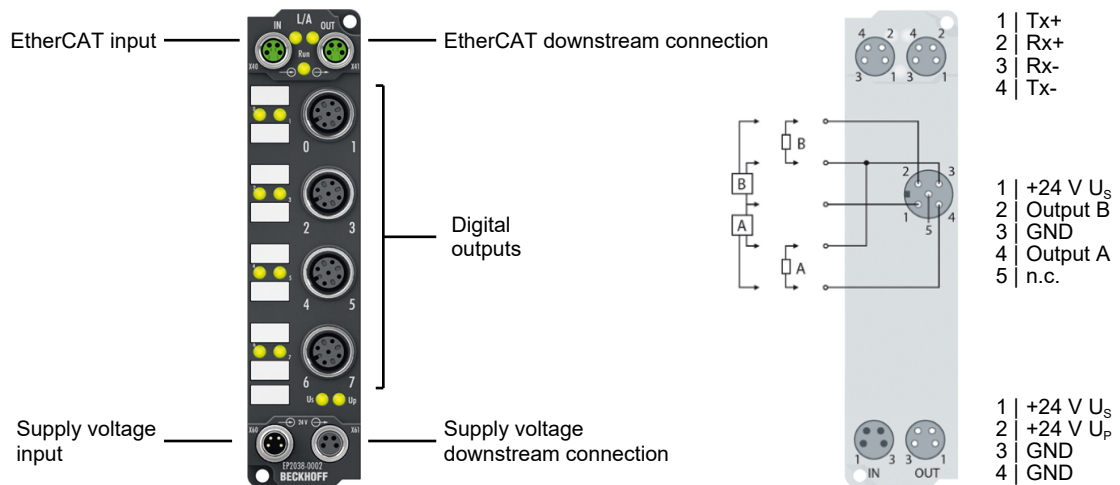

#### 8-channel digital output with diagnosis, 24 V<sub>DC</sub>, 2 A

The EP2038-000x EtherCAT Box is designed for processing digital/binary signals. It connects the binary control signals from the automation device on to the actuators at the process level. The outputs handle an output current of up to max. 2.0 A. A short-term overload is possible. The outputs are short-circuit proof. The sum current of all outputs is limited to 4 A.

The signal state of the channels is indicated by LEDs, see chapter [EP2038-000x - Status LEDs \[► 35\]](#). With channel-based short circuit and open-load/wire break detection, the EPP2038-000x provides effective diagnosis to ensure reliable system availability. The signal connection is established via screw-type M8 (EP2038-0001) or M12 (EP2038-0002) connectors.

**Quick links**

[Technical data \[▶ 24\]](#)

[Process image \[▶ 26\]](#)

[Dimensions \[▶ 85\]](#)

[EP2038-0001 Actuator connection \[▶ 98\]](#)

[EP2038-0002 Actuator connection \[▶ 99\]](#)



### 3.6.2 EP2038-000x - Technical data

All values are typical values over the entire temperature range, unless stated otherwise.

EtherCAT	
Connection	2 x M8 socket, 4-pin, A-coded, shielded
Electrical isolation	500 V

Supply voltages	
Connection	Input: M8 connector, 4-pin, A-coded Downstream connection: M8 socket, 4-pin, A-coded
$U_S$ nominal voltage	24 V <sub>DC</sub> (-15 % / +20 %)
$U_S$ sum current: $I_{S,sum}$	max. 4 A
Current consumption from $U_S$	120 mA
Rated voltage $U_P$	24 V <sub>DC</sub> (-15 % / +20 %)
$U_P$ sum current: $I_{P,sum}$	max. 4 A
Current consumption from $U_P$	20 mA + load
Electrical isolation GND <sub>S</sub> / GND <sub>P</sub>	no

Digital outputs	EP2038-0001	EP2038-0002
Number	8	
Connection	8 x M8 socket, 3-pin, A-coded	4 x M12 socket, 5-pin, A-coded
Load type	ohmic, inductive, lamp load	
Nominal output voltage	24 V <sub>DC</sub> from $U_P$	
Output current	max. 2 A per channel sum current of all outputs max. 4 A	
Minimum permitted load	200 mA	
Short-circuit current	15 A typ.	
Changeover times	$T_{ON}$ : 200 $\mu$ s typ., $T_{OFF}$ : 200 $\mu$ s typ.	
Diagnosis	<ul style="list-style-type: none"> <li>• Short circuit</li> <li>• Wire break detection (min. load &gt; 200 mA)</li> </ul>	
Auxiliary voltage output	24 V <sub>DC</sub> from $U_S$ max. 0.5 A in total, short-circuit proof in total	

Housing data	
Dimensions W x H x D	30 mm x 126 mm x 26.5 mm (without connectors)
Weight	approx. 165 g
Installation position	variable
Material	PA6 (polyamide)

Environmental conditions	
Ambient temperature during operation	-25 ... +60 °C -25 ... +55 °C according to cURus
Ambient temperature during storage	-40 ... +85 °C
Vibration resistance, shock resistance	conforms to EN 60068-2-6 / EN 60068-2-7 <a href="#">Additional tests [► 34]</a>
EMC immunity / emission	conforms to EN 61000-6-2 / EN 61000-6-4
Protection class	IP65, IP66, IP67 (conforms to EN 60529)

Approvals/markings	
Approvals/markings *)	CE, cURus [▶ 115]

\*) Real applicable approvals/markings see type plate on the side (product marking).

### Additional tests

The devices have undergone the following additional tests:

Test	Explanation
Vibration	10 frequency sweeps in 3 axes
	5 Hz < f < 60 Hz displacement 0.35 mm, constant amplitude
	60.1 Hz < f < 500 Hz acceleration 5 g, constant amplitude
Shocks	1000 shocks in each direction, in 3 axes
	35 g, 11 ms

### 3.6.3 EP2038-000x - Scope of supply

Make sure that the following components are included in the scope of delivery:

- 1x EtherCAT Box EP2038-000x
- 2x protective cap for EtherCAT socket, M8, green (pre-assembled)
- 1x protective cap for supply voltage input, M8, transparent (pre-assembled)
- 1x protective cap for supply voltage output, M8, black (pre-assembled)
- 10x labels, blank (1 strip of 10)

#### ● **Pre-assembled protective caps do not ensure IP67 protection**

**i** Protective caps are pre-assembled at the factory to protect connectors during transport. They may not be tight enough to ensure IP67 protection.

Ensure that the protective caps are correctly seated to ensure IP67 protection.

### 3.6.4 EP2038-000x - Status LEDs

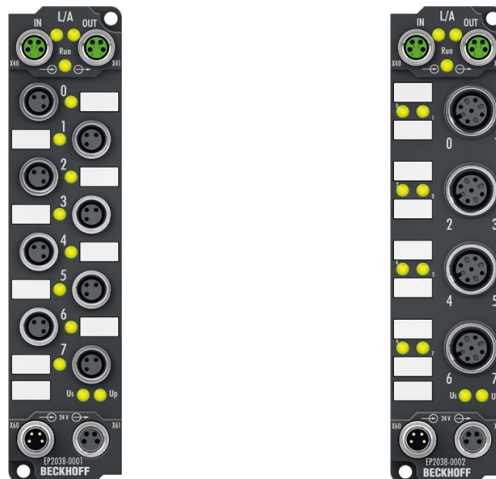

#### LED displays

LED	Display	Meaning
STATUS 0-7	green illuminated	the respective output is active
	red illuminated	the respective output has an error
Us	off	Supply voltage Us is not present
	green illuminated	Supply voltage Us is present
Up	off	Supply voltage Up is not present
	green illuminated	Supply voltage Up is present

### 3.6.5 EP2038-000x - Process image

#### Channel 1 to Channel 8

Under **Diag Channel 1** to **Diag Channel 8** you will find the diagnostic inputs of the 8 digital outputs of the module. Under **Channel 1** to **Channel 8** you will find the 8 digital outputs of the module (here as an example the EP2038-0001).

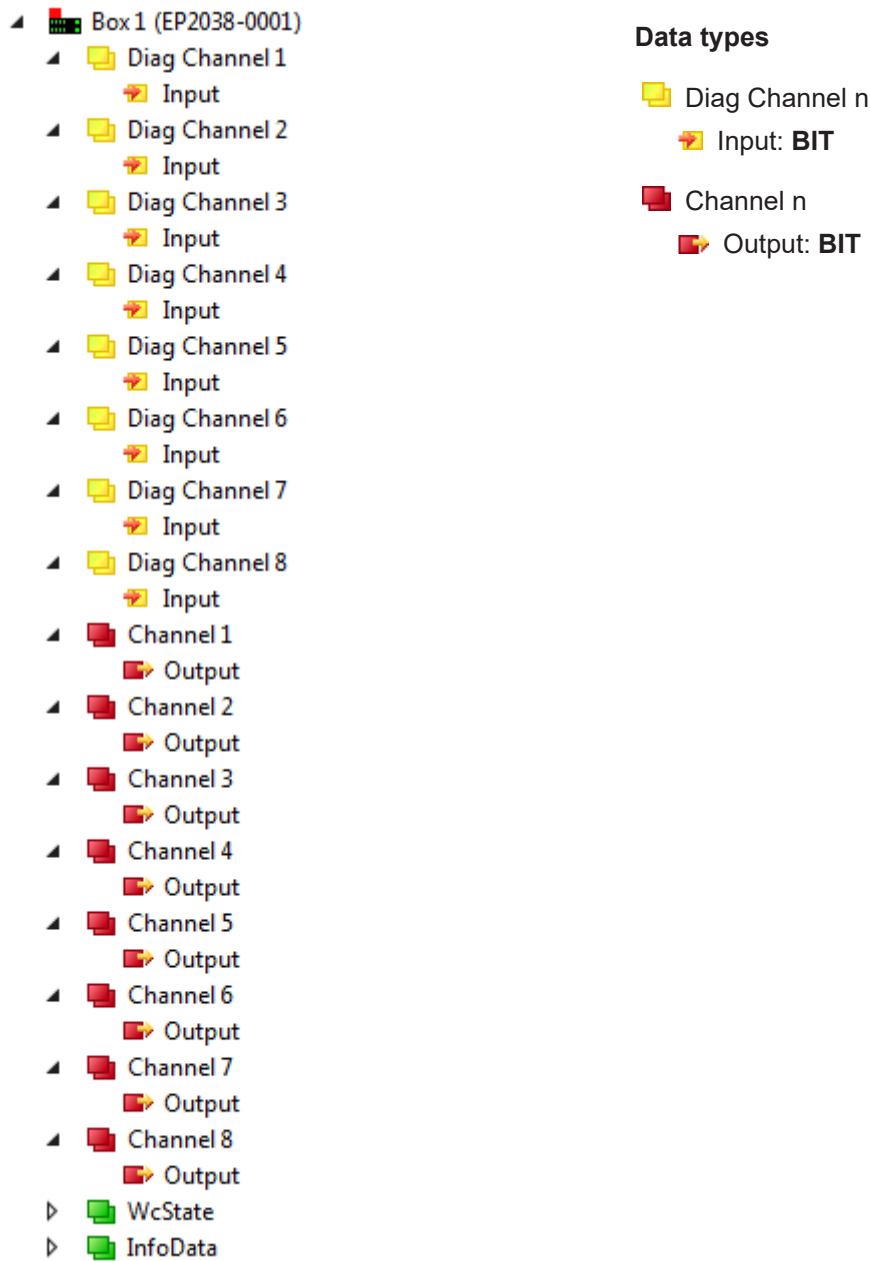

### 3.7 EP2038-0042

#### 3.7.1 EP2038-0042 - Introduction

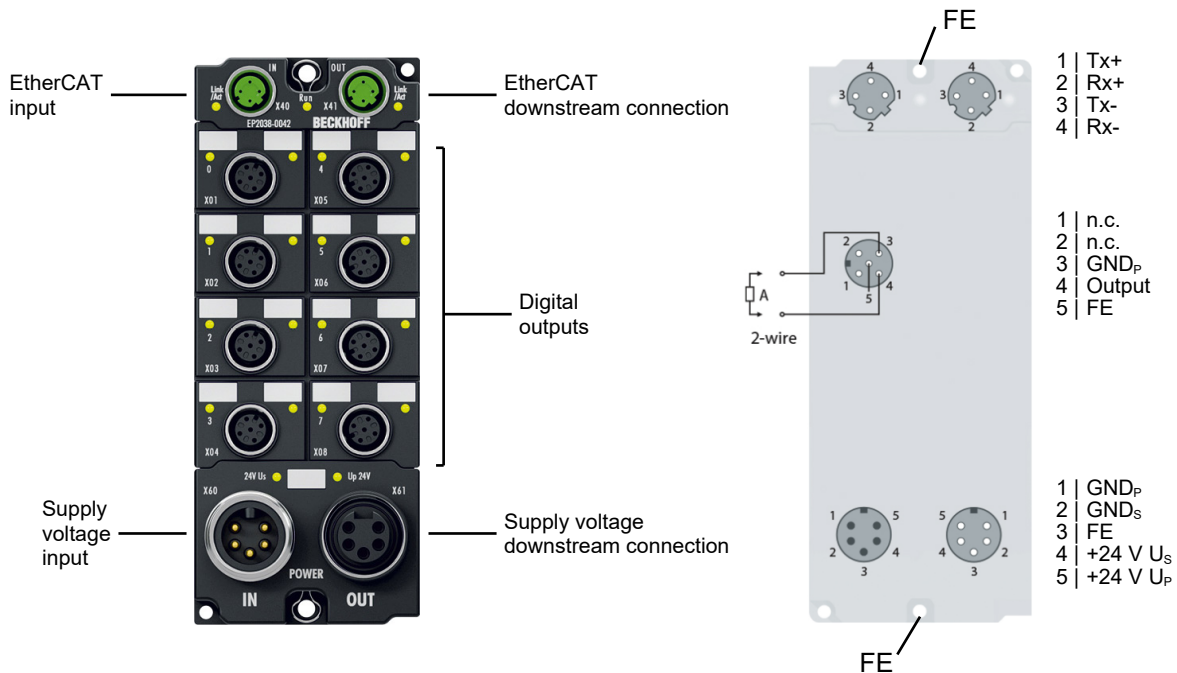

#### 8-channel digital output with diagnosis, 24 V<sub>DC</sub>, 2 A

The EP2038-0042 EtherCAT Box is designed for processing digital/binary signals. It connects the binary control signals from the automation device on to the actuators at the process level. The eight outputs each handle an output current of up to max. 2.4 A. A short-term overload is possible. The outputs are short-circuit proof. The sum current of all outputs is limited to 16 A. The signal state of the channels is indicated by LEDs. The signal connection is established via screw-type M12 connectors. One channel is available per M12 socket. Each output channel reports an "Open load" error or short circuit to the PLC via diagnosis. This diagnosis can be switched off channel by channel. Module-related undervoltage detection of the supply voltage takes place. The EP2038-0042 has M12 D-coded EtherCAT connections and 7/8" connectors for the power supply.

#### Special features

- Short circuit and open-load detection per channel
- Adjustable diagnosis per channel
- Undervoltage detection

The EP2038-0042 is interference-free. You can use the EP2038-0042 instead of an interference-free standard terminal in accordance with the following chapters of the [TwinSAFE Application Guide](#):

- "All-pole disconnection of a potential group with downstream interference-free standard terminals (Category 4, PL e)"
- "Single-pole disconnection of a potential group with downstream interference-free standard terminals with fault exclusion (Category 4, PL e)"
- „EL2911 potential group with interference-free standard terminals (Category 4, PL e)"

**Quick links**

[Technical data \[▶ 39\]](#)

[Process image \[▶ 41\]](#)

[Dimensions \[▶ 88\]](#)

[Actuator connection \[▶ 104\]](#)

[Behavior of the outputs in case of EtherCAT failure \[▶ 121\]](#)

### 3.7.2 EP2038-0042 - Technical data

All values are typical values over the entire temperature range, unless stated otherwise.

EtherCAT	
Connection	2 x M12 socket, 4-pin, D-coded, shielded
Electrical isolation	500 V
Distributed Clocks	yes

Supply voltages	
Connection	Input: 7/8" plug, 5-pin, 16-UN thread Downstream connection: 7/8" socket, 5-pin, 16-UN thread
U <sub>S</sub> nominal voltage	24 V <sub>DC</sub> (-15 % / +20 %)
U <sub>S</sub> sum current	max. 16 A at 40 °C
Current consumption from U <sub>S</sub>	130 mA
Rated voltage U <sub>P</sub>	24 V <sub>DC</sub> (-15 % / +20 %)
U <sub>P</sub> sum current	max. 16 A at 40 °C
Current consumption from U <sub>P</sub>	20 mA + load
Diagnostics	Undervoltage detection.
Electrical isolation GND <sub>S</sub> / GND <sub>P</sub>	yes

Digital outputs	
Number	8
Connection	8 x M12 socket, 5-pin, A-coded
Cable length	max. 30 m from the box to the actuator
Load type	Ohmic, inductive, lamp load up to 24 W
Nominal output voltage	24 V <sub>DC</sub> from U <sub>P</sub>
Output current	max. 2.4 A per channel. Each output is independently short-circuit proof. Sum current of all outputs: max. 16 A at 40 °C
Short-circuit current	3.2 A typ.
Output driver supply	from U <sub>P</sub>
Changeover times	T <sub>ON</sub> : 50 µs typ., T <sub>OFF</sub> : 100 µs typ.
Diagnosis	<ul style="list-style-type: none"> <li>• Short circuit</li> <li>• Open load / wire break</li> </ul>

Housing data	
Dimensions W x H x D	60 mm x 150 mm x 26,5 mm (without connectors)
Weight	approx. 440 g
Installation position	variable
Material	PA6 (polyamide)

Environmental conditions	
Ambient temperature during operation	-25 ... +60 °C
Ambient temperature during storage	-40 ... +85 °C
Vibration / shock resistance	conforms to EN 60068-2-6 / EN 60068-2-27
EMC immunity / emission	conforms to EN 61000-6-2 / EN 61000-6-4
Protection class	IP65, IP66, IP67 conforms to EN 60529

Approvals / markings	
Approvals / markings <sup>*)</sup>	CE, UL under preparation

\*) Real applicable approvals/markings see type plate on the side (product marking).

### Additional tests

The devices have undergone the following additional tests:

Test	Explanation
Vibration	10 frequency sweeps in 3 axes
	5 Hz < f < 60 Hz displacement 0.35 mm, constant amplitude
	60.1 Hz < f < 500 Hz acceleration 5 g, constant amplitude
Shocks	1000 shocks in each direction, in 3 axes
	35 g, 11 ms

### 3.7.3 EP2038-0042 - Scope of supply

Make sure that the following components are included in the scope of delivery:

- 1x EP2038-0042
- 2x protective cap for EtherCAT socket, M12 (pre-assembled)
- 1x Protective cap for supply voltage output, 7/8", black (pre-fitted)
- 10x labels, blank (1 strip of 10)

#### **● Pre-assembled protective caps do not ensure IP67 protection**

**i** Protective caps are pre-assembled at the factory to protect connectors during transport. They may not be tight enough to ensure IP67 protection.

Ensure that the protective caps are correctly seated to ensure IP67 protection.



### 3.7.4 EP2038-0042 - Process image

#### DO Diagnosis

#### NOTICE







































#### Some diagnostic functions are disabled in the factory setting

The following errors are only reported if you enable them beforehand:

"Open load"  
"Short to 24V"

- See chapter [Enable additional diagnostic functions](#) [► 126].













At DO Diagnosis you will find the diagnostic bits of the digital outputs.

- ▲  Box 1 (EP2038-0042)
  - ▲  DO Diagnosis
    - ▶  Channel 1 X01-4 Overcurrent
    - ▶  Channel 1 X01-4 Overload
    - ▶  Channel 1 X01-4 Open load
    - ▶  Channel 1 X01-4 Short to 24V
    - ▶  Channel 2 X02-4 Overcurrent
    - ▶  Channel 2 X02-4 Overload
    - ▶  Channel 2 X02-4 Open load
    - ▶  Channel 2 X02-4 Short to 24V
    - ▶  Channel 3 X03-4 Overcurrent
    - ▶  Channel 3 X03-4 Overload
    - ▶  Channel 3 X03-4 Open load
    - ▶  Channel 3 X03-4 Short to 24V
    - ▶  Channel 4 X04-4 Overcurrent
    - ▶  Channel 4 X04-4 Overload
    - ▶  Channel 4 X04-4 Open load
    - ▶  Channel 4 X04-4 Short to 24V
    - ▶  Channel 5 X05-4 Overcurrent
    - ▶  Channel 5 X05-4 Overload
    - ▶  Channel 5 X05-4 Open load
    - ▶  Channel 5 X05-4 Short to 24V
    - ▶  Channel 6 X06-4 Overcurrent
    - ▶  Channel 6 X06-4 Overload
    - ▶  Channel 6 X06-4 Open load
    - ▶  Channel 6 X06-4 Short to 24V
    - ▶  Channel 7 X07-4 Overcurrent
    - ▶  Channel 7 X07-4 Overload
    - ▶  Channel 7 X07-4 Open load
    - ▶  Channel 7 X07-4 Short to 24V
    - ▶  Channel 8 X08-4 Overcurrent
    - ▶  Channel 8 X08-4 Overload
    - ▶  Channel 8 X08-4 Open load
    - ▶  Channel 8 X08-4 Short to 24V
  - ▶  DEV Inputs Device
  - ▶  DO Outputs
  - ▶  WcState
  - ▶  InfoData

If you do not want to evaluate the diagnostic information, you can also remove this process data object from the process image. To do this, select the Predefined PDO Assignment "8DO" instead of "8DO full diagnosis".















## DEV Inputs Device

At DEV Inputs Device you will find, among other things, the diagnostic bits of the module.

- ▲  Box 1 (EP2038-0042)
  - ▷  DO Diagnosis
  - ▲  DEV Inputs Device
    - ▶  Undervoltage Us
    - ▶  Undervoltage Up
    - ▶  Overtemperature
    - ▶  Diag
    - ▶  TxPDO State
    - ▶  Input cycle counter
  - ▷  DO Outputs
  - ▷  WcState
  - ▷  InfoData

## DO Outputs

The digital outputs can be found under DO Outputs.

- ▲  Box 1 (EP2038-0042)
  - ▷  DO Diagnosis
  - ▷  DEV Inputs Device
  - ▲  DO Outputs
    - ▶  Channel 1 X01-4 Output
    - ▶  Channel 2 X02-4 Output
    - ▶  Channel 3 X03-4 Output
    - ▶  Channel 4 X04-4 Output
    - ▶  Channel 5 X05-4 Output
    - ▶  Channel 6 X06-4 Output
    - ▶  Channel 7 X07-4 Output
    - ▶  Channel 8 X08-4 Output
  - ▷  WcState
  - ▷  InfoData

### 3.8 EP2809-002x

#### 3.8.1 EP2809-002x - Introduction

##### EP2809-0021

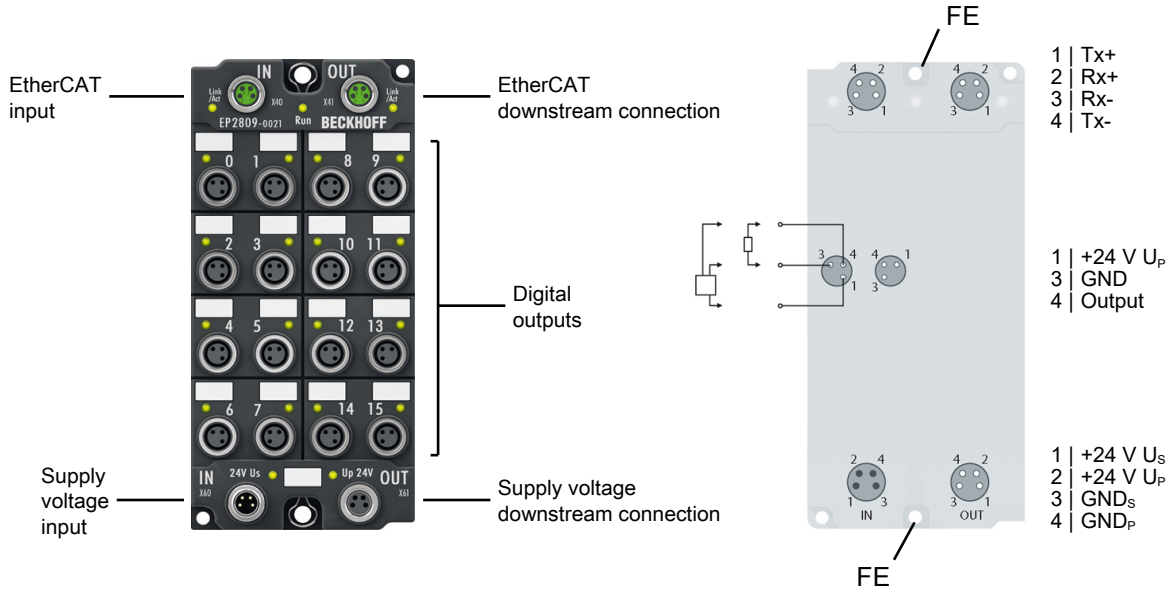

##### EP2809-0022

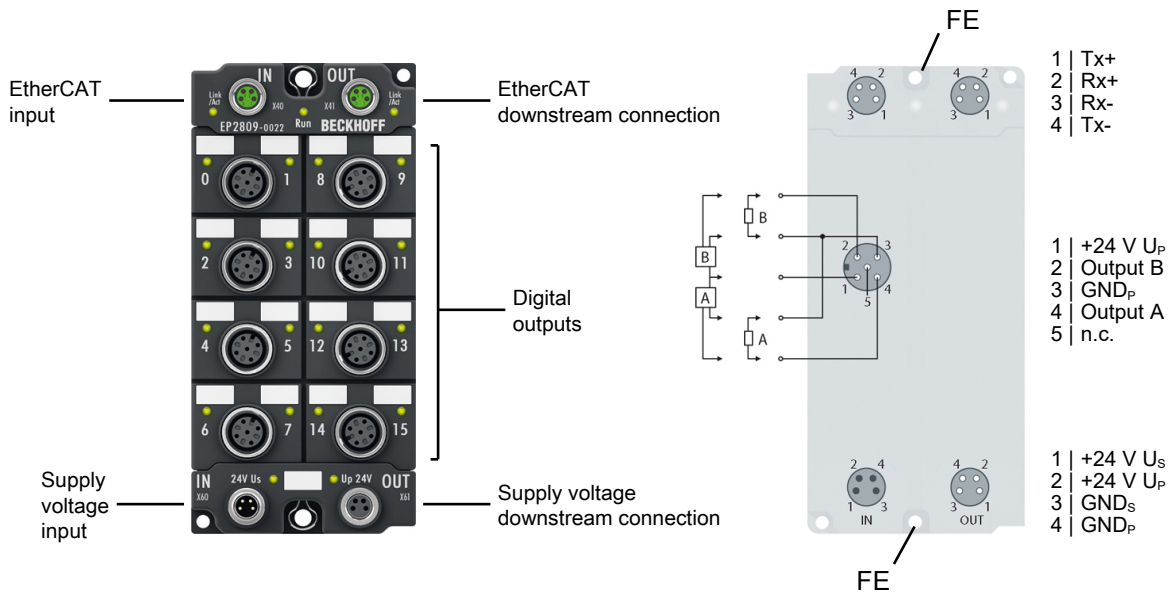

#### 16-channel digital output, 24 V<sub>DC</sub>, 0.5 A (Σ 4 A)

The EP2809-002x EtherCAT Box is designed for processing digital/binary signals. It connects the binary control signals from the automation device on to the actuators at the process level. The outputs handle an output current of up to max. 0.5 A. A short-term overload is possible. The outputs are short-circuit proof. The sum current of all outputs is limited to 4 A.

The signal state of the channels is indicated by LEDs. The signal connection is established via screw-type M8 (EP2809-0021) or M12 (EP2809-0022) connectors.

The 16-channel design offers high channel density in a small space.

**Quick links**

[Technical data \[▶ 45\]](#)

[Process image \[▶ 47\]](#)

[Dimensions \[▶ 86\]](#)

[EP2809-0021 actuator connection \[▶ 98\]](#)

[EP2809-0022 actuator connection \[▶ 99\]](#)

### 3.8.2 EP2809-002x - Technical data

All values are typical values over the entire temperature range, unless stated otherwise.

EtherCAT	
Connection	2 x M8 socket, 4-pin, A-coded, shielded
Electrical isolation	500 V

Supply voltages	
Connection	Input: M8 connector, 4-pin, A-coded Downstream connection: M8 socket, 4-pin, A-coded
$U_S$ nominal voltage	24 V <sub>DC</sub> (-15 % / +20 %)
$U_S$ sum current: $I_{S,sum}$	max. 4 A
Current consumption from $U_S$	120 mA
Rated voltage $U_P$	24 V <sub>DC</sub> (-15 % / +20 %)
$U_P$ sum current: $I_{P,sum}$	max. 4 A
Current consumption from $U_P$	20 mA + load
Electrical isolation GND <sub>S</sub> / GND <sub>P</sub>	yes

Digital outputs	EP2809-0021	EP2809-0022
Number	16	
Connection	16 x M8 socket, 3-pin, A-coded	8 x M12 socket, 5-pin, A-coded
Load type	ohmic, inductive, lamp load	
Nominal output voltage	24 V <sub>DC</sub> from $U_P$	
Output current	max. 0.5 A per channel, sum current of all outputs max. max. 4.0 A in total	
Short-circuit current	maximum 4.0 A	
Output driver supply	from $U_P$	
Changeover times	$T_{ON}$ : 60 μs typ., $T_{OFF}$ : 300 μs typ.	
Auxiliary voltage output	24 V <sub>DC</sub> from the peripheral voltage $U_P$ , max. sum current 0.5 A, short-circuit proof in total	

Housing data	
Dimensions W x H x D	60 mm x 126 mm x 26.5 mm (without plug connectors)
Weight	approx. 250 g
Installation position	variable
Material	PA6 (polyamide)

Environmental conditions	
Ambient temperature during operation	-25 ... +60 °C -25 ... +55 °C according to cURus
Ambient temperature during storage	-40 ... +85 °C
Vibration resistance, shock resistance	conforms to EN 60068-2-6 / EN 60068-2-27 Additional tests [► 46]
EMC immunity / emission	conforms to EN 61000-6-2 / EN 61000-6-4
Protection class	IP65, IP66, IP67 (conforms to EN 60529)

Approvals/markings	
Approvals/markings *)	CE, cURus [► 115]

\*) Real applicable approvals/markings see type plate on the side (product marking).

### Additional tests

The devices have undergone the following additional tests:

Test	Explanation
Vibration	10 frequency sweeps in 3 axes
	5 Hz < f < 60 Hz displacement 0.35 mm, constant amplitude
	60.1 Hz < f < 500 Hz acceleration 5 g, constant amplitude
Shocks	1000 shocks in each direction, in 3 axes
	35 g, 11 ms

### 3.8.3 EP2809-002x - Scope of supply

Make sure that the following components are included in the scope of delivery:

- 1x EtherCAT Box EP2809-002x
- 2x protective cap for EtherCAT socket, M8, green (pre-assembled)
- 1x protective cap for supply voltage input, M8, transparent (pre-assembled)
- 1x protective cap for supply voltage output, M8, black (pre-assembled)
- 10x labels, blank (1 strip of 10)

---

#### **● Pre-assembled protective caps do not ensure IP67 protection**

**i** Protective caps are pre-assembled at the factory to protect connectors during transport. They may not be tight enough to ensure IP67 protection.





















Ensure that the protective caps are correctly seated to ensure IP67 protection.

---



### 3.8.4 EP2809-002x - Process image

#### Channel 1 to Channel 16

Under **Channel 1** to **Channel 16** you will find the 16 digital outputs of the module (here as an example the EP2809-0021).

- ▲  Box 1 (EP2809-0021)
  - ▲  Channel 1
    -  Output
  - ▷  Channel 2
  - ▷  Channel 3
  - ▷  Channel 4
  - ▷  Channel 5
  - ▷  Channel 6
  - ▷  Channel 7
  - ▷  Channel 8
  - ▷  Channel 9
  - ▷  Channel 10
  - ▷  Channel 11
  - ▷  Channel 12
  - ▷  Channel 13
  - ▷  Channel 14
  - ▷  Channel 15
  - ▷  Channel 16
  - ▷  WcState
  - ▷  InfoData

#### Data types

-  Channel n
  -  Output: **BIT**

## 3.9 EP2809-0042

### 3.9.1 EP2809-0042 - Introduction

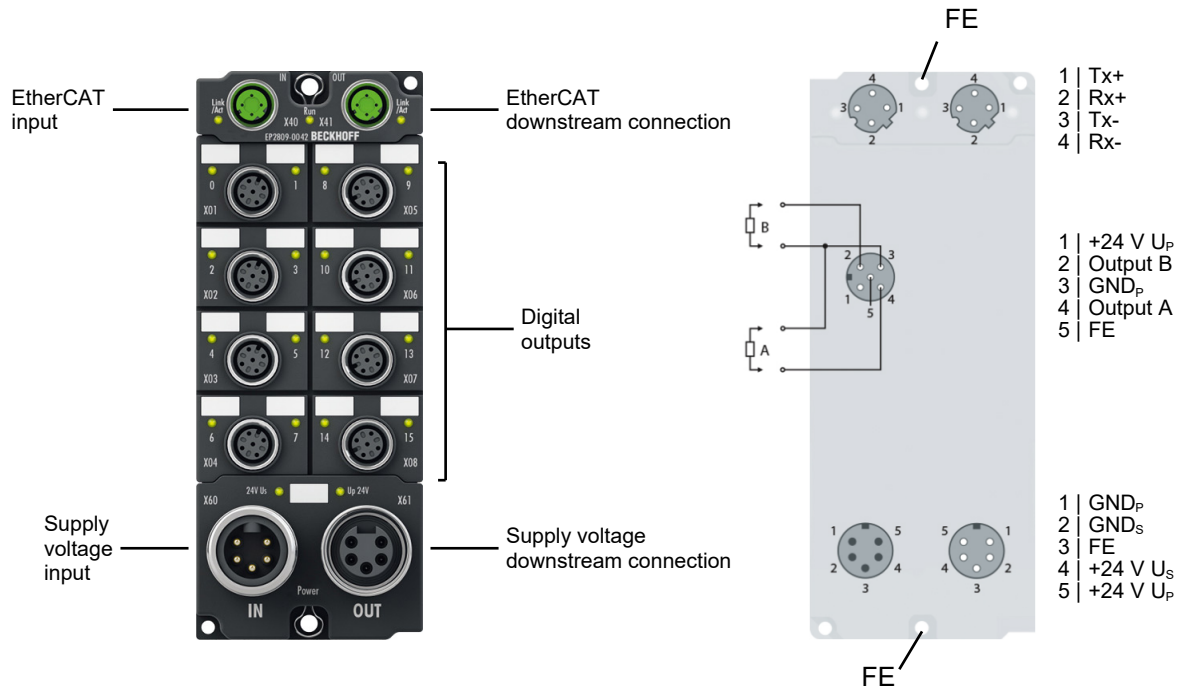

#### 16-channel digital output 24 V<sub>DC</sub>, 0.5 A (Σ 16 A)

The EP2809-0042 EtherCAT Box is designed for processing digital/binary signals. It connects the binary control signals from the automation device on to the actuators at the process level. The outputs handle an output current of up to max. 0.5 A. A short-term overload is possible. The outputs are short-circuit proof. The sum current of all outputs is limited to 16 A. 7/8" connectors are used to feed in and feed out the supply voltage.

The signal state of the channels is indicated by LEDs. The signal connection is established via screw-type M12 connectors. Two channels are available per M12 socket. The 16-channel design offers high channel density in a small space.

The EtherCAT connection is established via D-coded M12 sockets.

The EP2809-0042 is interference-free. You can use the EP2809-0042 instead of an interference-free standard terminal in accordance with the following chapters of the [TwinSAFE Application Guide](#):

- "All-pole disconnection of a potential group with downstream interference-free standard terminals (Category 4, PL e)"
- "Single-pole disconnection of a potential group with downstream interference-free standard terminals with fault exclusion (Category 4, PL e)"
- „EL2911 potential group with interference-free standard terminals (Category 4, PL e)"

#### Quick links

[Technical data](#) [▶ 49]

[Process image](#) [▶ 51]

[Dimensions](#) [▶ 88]

[Actuator connection](#) [▶ 105]



### 3.9.2 EP2809-0042 - Technical data

All values are typical values over the entire temperature range, unless stated otherwise.

EtherCAT	
Connection	2 x M12 socket, 4-pin, D-coded, shielded
Electrical isolation	500 V

Supply voltages	
Connection	Input: 7/8" plug, 5-pin, 16-UN thread Downstream connection: 7/8" socket, 5-pin, 16-UN thread
U <sub>s</sub> nominal voltage	24 V <sub>DC</sub> (-15 % / +20 %)
U <sub>s</sub> sum current	max. 16 A at 40 °C
Current consumption from U <sub>s</sub>	130 mA
Rated voltage U <sub>p</sub>	24 V <sub>DC</sub> (-15 % / +20 %)
U <sub>p</sub> sum current	max. 16 A at 40 °C
Current consumption from U <sub>p</sub>	20 mA + load
Electrical isolation GND <sub>s</sub> / GND <sub>p</sub>	yes

Digital outputs	
Number	16
Connection	8 x M12 socket, 5-pin, A-coded
Load type	ohmic, inductive, lamp load
Nominal output voltage	24 V <sub>DC</sub> from U <sub>p</sub>
Output current	max. 0.5 A on each channel, individually short-circuit proof
Short-circuit current	1.9 A typ.
Output driver supply	from U <sub>p</sub>
Changeover times	T <sub>ON</sub> : 60 µs typ., T <sub>OFF</sub> : 300 µs typ.
Auxiliary voltage output	24 V <sub>DC</sub> from U <sub>p</sub> max. 0.5 A in total, short-circuit proof in total

Housing data	
Dimensions W x H x D	60 mm x 150 mm x 26,5 mm (without connectors)
Weight	approx. 440 g
Installation position	variable
Material	PA6 (polyamide)

Environmental conditions	
Ambient temperature during operation	-25 ... +60 °C
Ambient temperature during storage	-40 ... +85 °C
Vibration / shock resistance	conforms to EN 60068-2-6 / EN 60068-2-27
EMC immunity / emission	conforms to EN 61000-6-2 / EN 61000-6-4
Protection class	IP65, IP66, IP67 conforms to EN 60529

Approvals/markings	
Approvals/markings *)	CE, cURus [ <a href="#">▶ 115</a> ]

\*) Real applicable approvals/markings see type plate on the side (product marking).

#### Additional tests

The devices have undergone the following additional tests:

Test	Explanation
Vibration	10 frequency sweeps in 3 axes
	5 Hz < f < 60 Hz displacement 0.35 mm, constant amplitude
	60.1 Hz < f < 500 Hz acceleration 5 g, constant amplitude
Shocks	1000 shocks in each direction, in 3 axes
	35 g, 11 ms

### 3.9.3 EP2809-0042 - Scope of supply

Make sure that the following components are included in the scope of delivery:

- 1x EtherCAT Box EP2809-0042
- 2x protective cap for EtherCAT socket, M12 (pre-assembled)
- 1x Protective cap for supply voltage output, 7/8", black (pre-fitted)
- 10x labels, blank (1 strip of 10)

---

#### **● Pre-assembled protective caps do not ensure IP67 protection**

**i** Protective caps are pre-assembled at the factory to protect connectors during transport. They may not be tight enough to ensure IP67 protection.

Ensure that the protective caps are correctly seated to ensure IP67 protection.

---

### 3.9.4 EP2809-0042 - Process image

The process image contains a process data object for each digital output.

The name of each process data object contains the name of the socket and the pin number of the corresponding digital output.

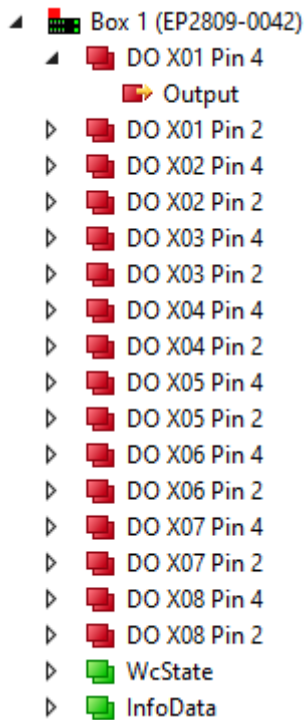
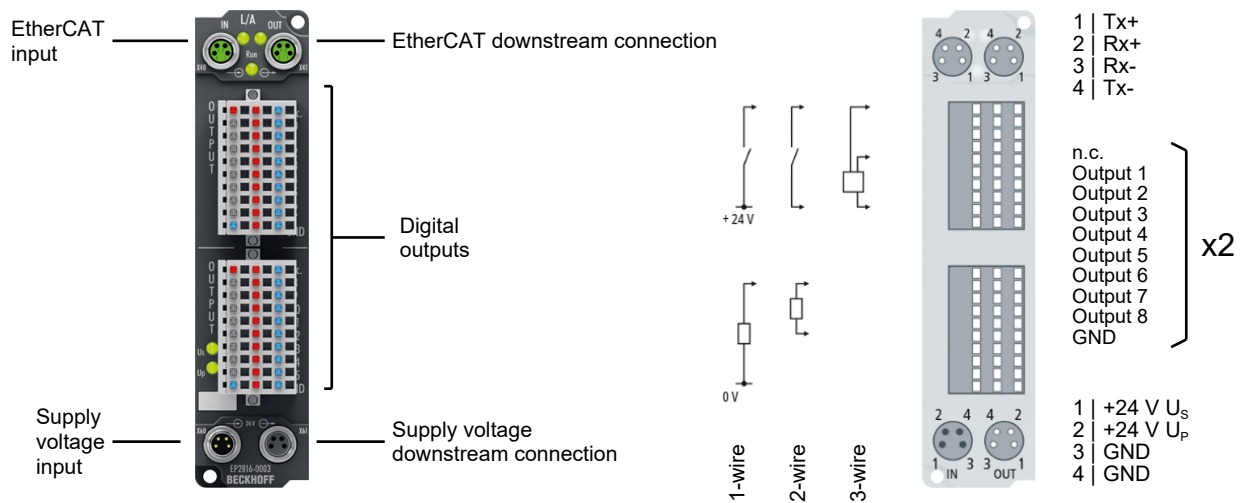

Fig. 4: EP2809-0042 Process image

### 3.10 EP2816-00xx

#### 3.10.1 EP2816-0003 - Introduction



#### 16-channel digital output, 24 V<sub>DC</sub>, 0.5 A (Σ 4 A), IP20 connector

The EP2816-0003 EtherCAT Box is designed for processing digital/binary signals. It connects the binary control signals from the automation device on to the actuators at the process level. The outputs handle an output current of up to max. 0.5 A. A short-term overload is possible. The outputs are short-circuit proof.

An output short circuit is recognized and passed on to the control level.

The sum current of all outputs is limited to 4 A.

The signal state is indicated for signal groups by means of LEDs. The signal connection is established via spring-loaded connectors, optionally available in 1-pin and 3-pin versions. The module is supplied without connectors. The 16-channel design offers high channel density in a small space. The protection rating is limited due to the spring-loaded connector.

#### Quick links

[Technical data \[► 56\]](#)

[Process image \[► 60\]](#)

[Dimensions \[► 85\]](#)

[Actuator connection \[► 107\]](#)

### 3.10.2 EP2816-0004 - Introduction

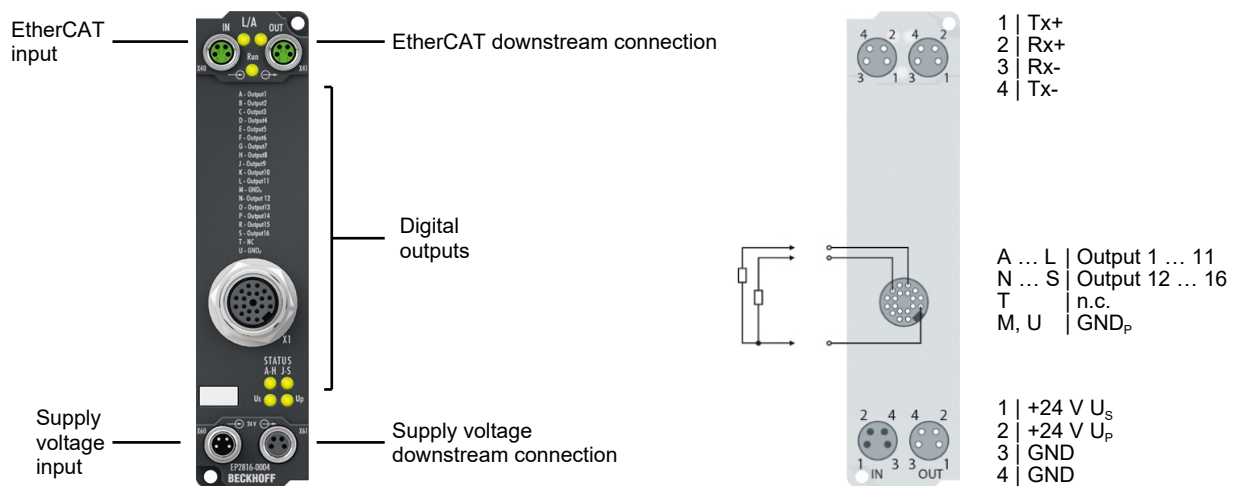

#### 16-channel digital output, 24 V<sub>DC</sub>, 0.5 A (Σ 4 A)

The EP2816-0004 EtherCAT Box is designed for processing digital/binary signals. It connects the binary control signals from the automation device on to the actuators at the process level. The outputs handle an output current of up to max. 0.5 A. A short-term overload is possible. The outputs are short-circuit proof.

An output short circuit is recognized and passed on to the control level.

The sum current of all outputs is limited to 4 A.

The signal state is indicated in groups via LEDs, see chapter [EP2816-0004, EP2816-0008 - Status LEDs](#) [► 58]. The signal connection is established via a 19-pin M16 socket. The 16-channel design offers high channel density in a small space. With IP67 D-sub connectors, 16-channel valve terminals can be connected cost-effectively and decentralized in the field.

#### Quick links

[Technical data](#) [► 56]

[Process image](#) [► 60]

[Dimensions](#) [► 85]

[Actuator connection](#) [► 109]

### 3.10.3 EP2816-0008 - Introduction

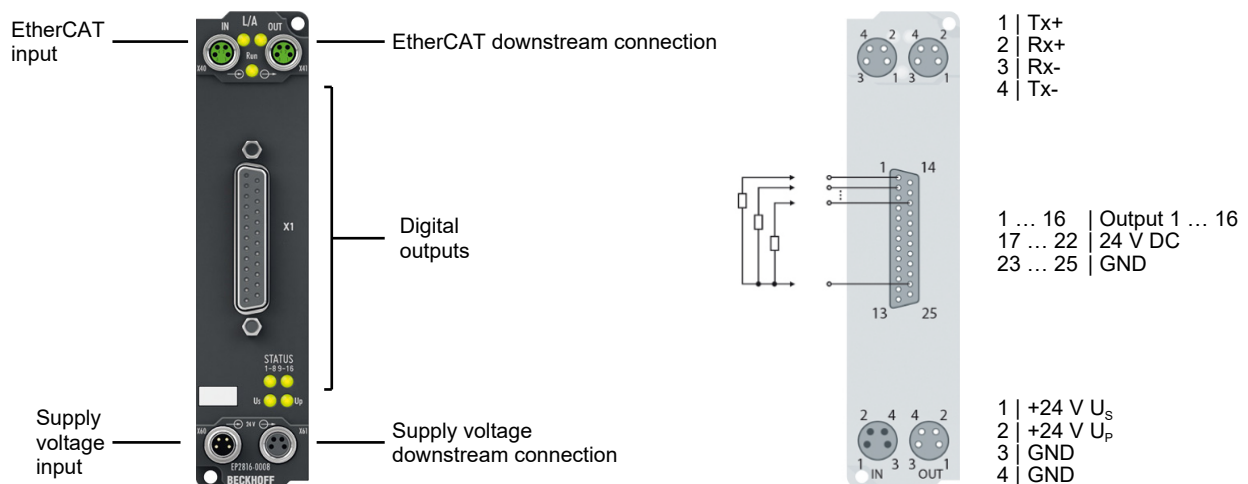

#### 16-channel digital output, 24 V<sub>DC</sub>, 0.5 A (Σ 4 A)

The EP2816-0008 EtherCAT Box is designed for processing digital/binary signals. It connects the binary control signals from the automation device on to the actuators at the process level. The outputs handle an output current of up to max. 0.5 A. A short-term overload is possible. The outputs are short-circuit proof.

An output short circuit is recognized and passed on to the control level.

The sum current of all outputs is limited to 4 A.

The signal state is indicated in groups via LEDs, see chapter [EP2816-0004, EP2816-0008 - Status LEDs](#) [► 58]. The signal connection is established via a 25-pin D-sub socket. The 16-channel design offers high channel density in a small space. With IP67 D-sub connectors, 16-channel valve terminals can be connected cost-effectively and decentralized in the field.

#### Quick links

[Technical data](#) [► 56]

[Process image](#) [► 60]

[Dimensions](#) [► 85]

[Actuator connection](#) [► 111]

### 3.10.4 EP2816-0010 - Introduction

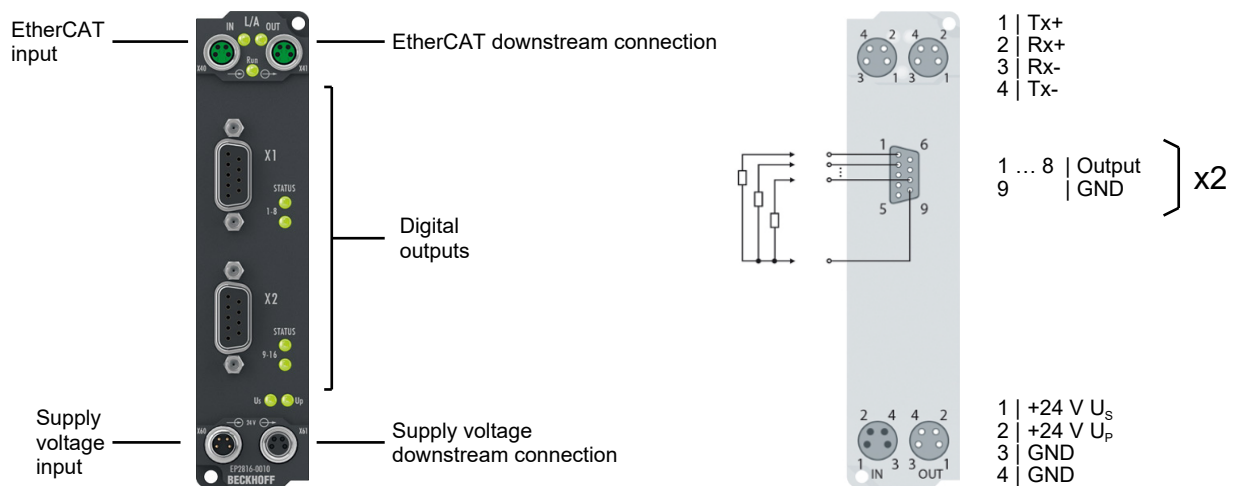

#### 16-channel digital output, 24 V<sub>DC</sub>, 0.5 A (Σ 4 A)

The EP2816-0010 EtherCAT Box is designed for processing digital/binary signals. It connects the binary control signals from the automation device on to the actuators at the process level. The outputs handle an output current of up to max. 0.5 A. A short-term overload is possible. The outputs are short-circuit proof.

An output short circuit is recognized and passed on to the control level.

The sum current of all outputs is limited to 4 A.

The signal state is indicated in groups via LEDs, see chapter [EP2816-0010 - Status LEDs \[► 59\]](#). The signal connection is established through two 9-pin D-sub sockets. The 2x8-channel design offers high channel density in a small space. With two D-sub connectors, 8-channel valve terminals can be connected cost-effectively and decentralized in the field.

#### Quick links

[Technical data \[► 56\]](#)

[Process image \[► 60\]](#)

[Dimensions \[► 85\]](#)

[Actuator connection \[► 110\]](#)

### 3.10.5 EP2816-00xx - Technical data

All values are typical values over the entire temperature range, unless stated otherwise.

EtherCAT	EP2816-0003	EP2816-0004	EP2816-0008	EP2816-0010
Connection	2 x M8 socket, 4-pin, A-coded, shielded			
Electrical isolation	500 V			
Distributed Clocks	-	yes	yes	yes

Supply voltages	
Connection	Input: M8 connector, 4-pin, A-coded Downstream connection: M8 socket, 4-pin, A-coded
$U_S$ nominal voltage	24 V <sub>DC</sub> (-15 % / +20 %)
$U_S$ sum current: $I_{S,sum}$	max. 4 A
Current consumption from $U_S$	120 mA
Rated voltage $U_P$	24 V <sub>DC</sub> (-15 % / +20 %)
$U_P$ sum current: $I_{P,sum}$	max. 4 A
Current consumption from $U_P$	20 mA + load
Electrical isolation GND <sub>S</sub> / GND <sub>P</sub>	no

Digital outputs	EP2816-0003	EP2816-0004	EP2816-0008	EP2816-0010
Number	16			
Connection	2x ZS2001	1x M16 socket, 19-pin	1 x D-sub socket, 25-pin, UNC4-40 thread	2 x D-sub socket, 9-pin
Cable length to the actuator	max. 30 m	-	-	-
Load type	ohmic, inductive, lamp load			
Nominal output voltage	24 V <sub>DC</sub> from $U_P$			
Output current	max. 0.5 A on each channel, individually short-circuit proof max. 4.0 A in total			
Short circuit current	maximum 1.5 A			
Output driver supply	from $U_P$			
Switching times	$T_{ON}$ : 25 $\mu$ s typ., $T_{OFF}$ : 50 $\mu$ s typ.		$T_{ON}$ : 60 $\mu$ s typ., $T_{OFF}$ : 300 $\mu$ s typ.	
Auxiliary voltage output	-	-	24 V <sub>DC</sub> from $U_S$	-

Housing data	
Dimensions W x H x D	30 mm x 126 mm x 26.5 mm (without plug connectors)
Weight	approx. 165 g
Installation position	variable
Material	PA6 (polyamide)

Environmental conditions	EP2816-0003	EP2816-0004	EP2816-0008	EP2816-0010
Ambient temperature during operation	-25...+60 °C -25...+55 °C according to cURus			
Ambient temperature during storage	-40...+85 °C			
Vibration resistance, shock resistance	conforms to EN 60068-2-6 / EN 60068-2-27 Additional checks [► 57]			
EMC immunity / emission	conforms to EN 61000-6-2 / EN 61000-6-4			
Degree of protection	IP20	IP65, IP66, IP67 (conforms to EN 60529)		



Approvals/markings	
Approvals/markings *)	CE, cURus [▶ 115]

\*) Real applicable approvals/markings see type plate on the side (product marking).

**Additional tests**

The devices have undergone the following additional tests:

Test	Explanation
Vibration	10 frequency sweeps in 3 axes
	5 Hz < f < 60 Hz displacement 0.35 mm, constant amplitude
	60.1 Hz < f < 500 Hz acceleration 5 g, constant amplitude
Shocks	1000 shocks in each direction, in 3 axes
	35 g, 11 ms

**3.10.6 EP2816-00xx - Scope of supply**

Make sure that the following components are included in the scope of delivery:

- 1x EtherCAT Box
- 2x protective cap for EtherCAT socket, M8, green (pre-assembled)
- 1x protective cap for supply voltage input, M8, transparent (pre-assembled)
- 1x protective cap for supply voltage output, M8, black (pre-assembled)
- 10x labels, blank (1 strip of 10)

**● Pre-assembled protective caps do not ensure IP67 protection**

**i** Protective caps are pre-assembled at the factory to protect connectors during transport. They may not be tight enough to ensure IP67 protection.

Ensure that the protective caps are correctly seated to ensure IP67 protection.

### 3.10.7 EP2816-0004, EP2816-0008 - Status LEDs



LED	Display	Meaning
STATUS 1-8	green illuminated	at least one of the outputs for channel 1-8 is set
	red illuminated	at least one of the outputs for channel 1-8 has a short-circuit
STATUS 9-16	green illuminated	at least one of the outputs for channel 9-16 is set
	red illuminated	at least one of the outputs for channel 9-16 has a short-circuit
Us	off	The supply voltage, Us, is not present
	green illuminated	The supply voltage, Us, is present
Up	off	The supply voltage, Up, is not present
	green illuminated	The supply voltage, Up, is present

### 3.10.8 EP2816-0010 - Status LEDs



LED	Display	Meaning
STATUS 1-8	green illuminated	at least one of the outputs for channel 1-8 is set
	red illuminated	at least one of the outputs for channel 1-8 has a short-circuit
STATUS 9-16	green illuminated	at least one of the outputs for channel 9-16 is set
	red illuminated	at least one of the outputs for channel 9-16 has a short-circuit
Us	off	The supply voltage, Us, is not present
	green illuminated	The supply voltage, Us, is present
Up	off	The supply voltage, Up, is not present
	green illuminated	The supply voltage, Up, is present

### 3.10.9 EP2816-00xx - Process image

#### DIG Diag Inputs Channel 1

You will find the diagnostic inputs for the module's first 8 digital outputs under **DIG Diag Inputs Channel 1**.

- └─ Box 1 (EP2816-0004)
  - └─ DIG Diag Inputs Channel 1
    - └─ Diag Input 1
    - └─ Diag Input 2
    - └─ Diag Input 3
    - └─ Diag Input 4
    - └─ Diag Input 5
    - └─ Diag Input 6
    - └─ Diag Input 7
    - └─ Diag Input 8
  - └─ DIG Diag Inputs Channel 2
  - └─ DIG Inputs Device
  - └─ DIG Output Channel 1
  - └─ DIG Output Channel 2
  - └─ DIG Outputs Device
  - └─ WcState
  - └─ InfoData

#### Data types

- └─ DIG Diag Inputs Channel 1
  - └─ Diag Input n: **BIT**

#### Diag Input n

Indicates an error on Output n.

#### DIG Diag Inputs Channel 2

You will find the diagnostic inputs for the module's second 8 digital outputs under **DIG Diag Inputs Channel 2**.

- └─ Box 1 (EP2816-0004)
  - └─ DIG Diag Inputs Channel 1
  - └─ DIG Diag Inputs Channel 2
    - └─ Diag Input 1
    - └─ Diag Input 2
    - └─ Diag Input 3
    - └─ Diag Input 4
    - └─ Diag Input 5
    - └─ Diag Input 6
    - └─ Diag Input 7
    - └─ Diag Input 8
  - └─ DIG Inputs Device
  - └─ DIG Output Channel 1
  - └─ DIG Output Channel 2
  - └─ DIG Outputs Device
  - └─ WcState
  - └─ InfoData

#### Data types

- └─ DIG Diag Inputs Channel 2
  - └─ Diag Input n: **BIT**

#### Diag Input n

Indicates an error on Output n.

**DIG Inputs Device**

You will find the module's status inputs under **DIG Inputs Device**.

- ▲ Box 1 (EP2816-0004)
  - ▷ DIG Diag Inputs Channel 1
  - ▷ DIG Diag Inputs Channel 2
  - ▲ DIG Inputs Device
    - Safe state active
    - Error channel 1
    - Error channel 2
    - Sync error
    - TxPDO Toggle
  - ▷ DIG Output Channel 1
  - ▷ DIG Output Channel 2
  - ▷ DIG Outputs Device
  - ▷ WcState
  - ▷ InfoData

**Data types**

- DIG Inputs Device
  - Safe state active: **BIT**
  - Error channel 1: **BIT**
  - Error channel 1: **BIT**
  - Sync error: **BIT**
  - TxPDO Toggle: **BIT**

**Safe state active**

Indicates whether the safe state has been assumed. The display only works if the network transmits process input data, i.e. in the network states Safe-Operational (Safe-OP) and Operational (OP), but not in the network state INIT.

**Error channel X**

Indicates an error on channel X.

**Sync Error**

















See EtherCAT system documentation.

**TxPDO Toggle**



See EtherCAT system documentation.

## DIG Outputs Channel 1

You will find the first 8 digital outputs of the module under **DIG Outputs Channel 1**.

















- └─  Box 1 (EP2816-0004)
  - └─  DIG Diag Inputs Channel 1
  - └─  DIG Diag Inputs Channel 2
  - └─  DIG Inputs Device
  - └─  DIG Output Channel 1
    - └─  Output 1
    - └─  Output 2
    - └─  Output 3
    - └─  Output 4
    - └─  Output 5
    - └─  Output 6
    - └─  Output 7
    - └─  Output 8
  - └─  DIG Output Channel 2
  - └─  DIG Outputs Device
  - └─  WcState
  - └─  InfoData

### Data types



- └─  DIG Output Channel 1
  - └─  Output n: **BIT**

## DIG Outputs Channel 2

You will find the second 8 digital outputs of the module under **DIG Outputs Channel 2**.











- └─  Box 1 (EP2816-0004)
  - └─  DIG Diag Inputs Channel 1
  - └─  DIG Diag Inputs Channel 2
  - └─  DIG Inputs Device
  - └─  DIG Output Channel 1
  - └─  DIG Output Channel 2
    - └─  Output 1
    - └─  Output 2
    - └─  Output 3
    - └─  Output 4
    - └─  Output 5
    - └─  Output 6
    - └─  Output 7
    - └─  Output 8
  - └─  DIG Outputs Device
  - └─  WcState
  - └─  InfoData

### Data types



- └─  DIG Output Channel 2
  - └─  Output n: **BIT**

**DIG Outputs Device**

You will find the module's control outputs under **DIG Outputs Device**.

- ▲  Box 1 (EP2816-0004)
  - ▷  DIG Diag Inputs Channel 1
  - ▷  DIG Diag Inputs Channel 2
  - ▷  DIG Inputs Device
  - ▷  DIG Output Channel 1
  - ▷  DIG Output Channel 2
  - ▲  DIG Outputs Device
    - ▶  Set safe state
    - ▶  Reset outputs
  - ▷  WcState
  - ▷  InfoData

**Data types**

-  DIG Outputs Device
  - ▶  Set safe state: **BIT**
  - ▶  Reset outputs: **BIT**

**Set safe state**

Sets the module to the safe state.

**Reset outputs**

Resets the error bits "Error channel X" of the module. The outputs are reactivated.

## 3.11 EP2817-0008

### 3.11.1 EP2817-0008 - Introduction

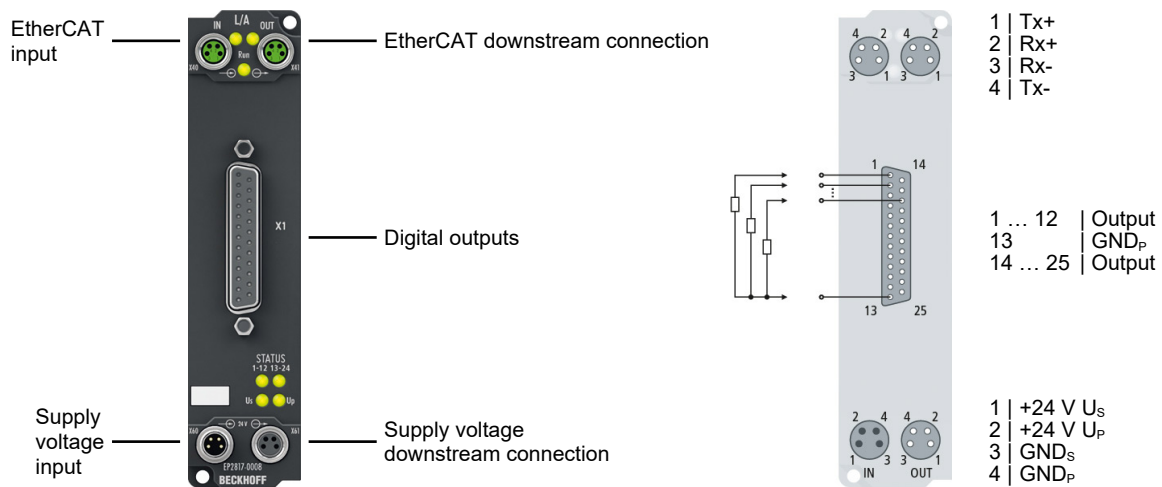

#### 24-channel digital output, 24 V<sub>DC</sub>, 0.5 A (Σ 4 A)

The EP2817-0008 EtherCAT Box is designed for processing digital/binary signals. It connects the binary control signals from the automation device on to the actuators at the process level. The outputs handle an output current of up to max. 0.5 A. A short-term overload is possible. The outputs are short-circuit proof.

An output short circuit is recognized and passed on to the control level.

The sum current of all outputs is limited to 4 A.

The signal state is indicated in groups via LEDs, see chapter [EP2817-0008 - Status LEDs \[▶ 67\]](#). The signal connection is established via a 25-pin D-sub socket. The 24-channel design offers high channel density in a small space. With IP67 D-sub connectors, 24-channel valve terminals can be connected cost-effectively and decentralized in the field.

#### Quick links

[Technical data \[▶ 65\]](#)

[Process image \[▶ 68\]](#)

[Dimensions \[▶ 85\]](#)

[Actuator connection \[▶ 113\]](#)



### 3.11.2 EP2817-0008 - Technical data

All values are typical values over the entire temperature range, unless stated otherwise.

EtherCAT	
Connection	2 x M8 socket, 4-pin, A-coded, shielded
Electrical isolation	500 V
Distributed Clocks	yes

Supply voltages	
Connection	Input: M8 connector, 4-pin, A-coded Downstream connection: M8 socket, 4-pin, A-coded
U <sub>S</sub> nominal voltage	24 V <sub>DC</sub> (-15 % / +20 %)
U <sub>S</sub> sum current: I <sub>S,sum</sub>	max. 4 A
Current consumption from U <sub>S</sub>	120 mA
Rated voltage U <sub>P</sub>	24 V <sub>DC</sub> (-15 % / +20 %)
U <sub>P</sub> sum current: I <sub>P,sum</sub>	max. 4 A
Current consumption from U <sub>P</sub>	20 mA + load
Diagnostics	Undervoltage detection < 18 V <sub>DC</sub> for U <sub>S</sub> and U <sub>P</sub>
Electrical isolation GND <sub>S</sub> / GND <sub>P</sub>	yes

Digital outputs	
Number	24
Connection	D-sub socket, 25-pin, UNC4-40 thread
Load type	ohmic, inductive, lamp load
Nominal output voltage	24 V <sub>DC</sub> from U <sub>P</sub>
Output current	max. 0.5 A on each channel, individually short-circuit proof max. 4.0 A in total
Short circuit current	max. 1.0 A
Switching times	T <sub>ON</sub> : 10 µs typ., T <sub>OFF</sub> : 50 µs typ.

Housing data	
Dimensions W x H x D	30 mm x 126 mm x 26.5 mm (without connectors)
Weight	approx. 165 g
Installation position	variable
Material	PA6 (polyamide)

Environmental conditions	
Ambient temperature during operation	-25 ... +60 °C -25 ... +55 °C according to cURus
Ambient temperature during storage	-40 ... +85 °C
Vibration resistance, shock resistance	conforms to EN 60068-2-6 / EN 60068-2-27 Additional tests [► 66]
EMC immunity / emission	conforms to EN 61000-6-2 / EN 61000-6-4
Protection class	IP65, IP66, IP67 (conforms to EN 60529)

Approvals/markings	
Approvals/markings *)	CE, cURus [► 115]

\*) Real applicable approvals/markings see type plate on the side (product marking).

### Additional tests

The devices have undergone the following additional tests:

Test	Explanation
Vibration	10 frequency sweeps in 3 axes
	5 Hz < f < 60 Hz displacement 0.35 mm, constant amplitude
	60.1 Hz < f < 500 Hz acceleration 5 g, constant amplitude
Shocks	1000 shocks in each direction, in 3 axes
	35 g, 11 ms

### 3.11.3 EP2817-0008 - Scope of supply

Make sure that the following components are included in the scope of delivery:

- 1x EtherCAT Box EP2817-0008
- 2x protective cap for EtherCAT socket, M8, green (pre-assembled)
- 1x protective cap for supply voltage input, M8, transparent (pre-assembled)
- 1x protective cap for supply voltage output, M8, black (pre-assembled)
- 10x labels, blank (1 strip of 10)

---

#### **● Pre-assembled protective caps do not ensure IP67 protection**

**i** Protective caps are pre-assembled at the factory to protect connectors during transport. They may not be tight enough to ensure IP67 protection.

Ensure that the protective caps are correctly seated to ensure IP67 protection.

---

### 3.11.4 EP2817-0008 - Status LEDs



LED	Display	Meaning
STATUS 1-12	green illuminated	at least one of the outputs for channel 1-12 is set
	red illuminated	at least one output of channels 1-12 has an error
STATUS 13-24	green illuminated	at least one of the outputs for channel 13-24 is set
	red illuminated	at least one output of channels 13 - 24 has an error
Us	off	Supply voltage Us is not present
	green illuminated	Supply voltage Us is present
Up	off	Supply voltage Up is not present
	green illuminated	Supply voltage Up is present

### 3.11.5 EP2817-0008 - Process image

#### DIG Diag Inputs Channel 1

Under **DIG Diag Inputs Channel 1 - 3** you will find the diagnostic inputs of the 8 digital outputs (DIG Outputs Channel 1 - 3) of the module.

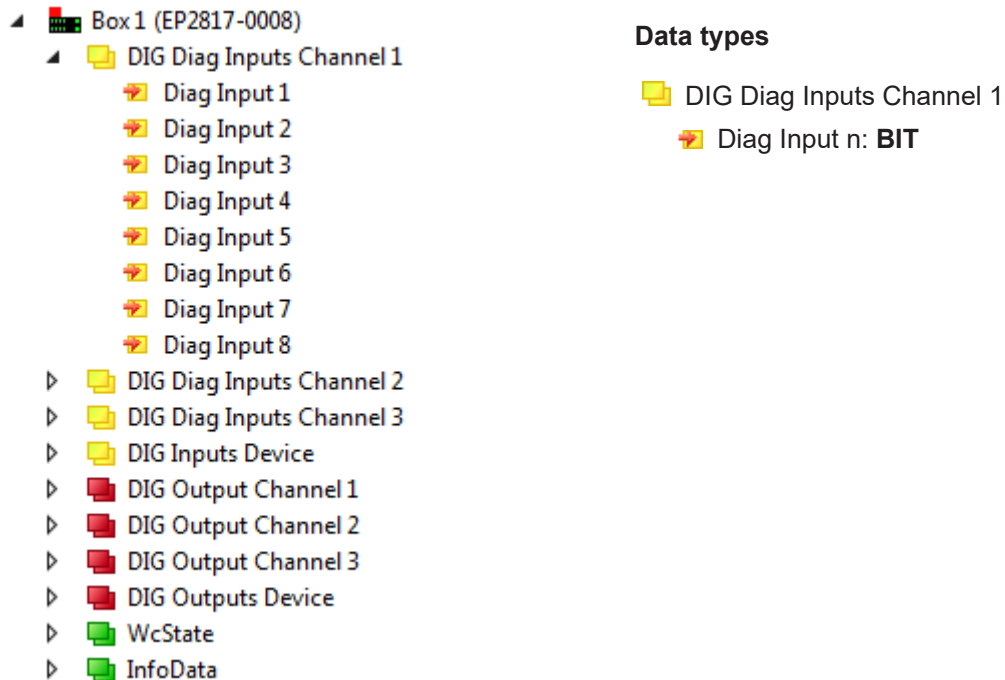

#### Diag Input n

Indicates an error at output n, i.e. an output switched ON is OFF, or an output switched OFF is ON

### DIG Inputs Device

You will find the module's status inputs under **DIG Inputs Device**.

- └─ Box 1 (EP2817-0008)
  - DIG Diag Inputs Channel 1
  - DIG Diag Inputs Channel 2
  - DIG Diag Inputs Channel 3
  - └─ DIG Inputs Device
    - Safe state active
    - Error channel 1
    - Error channel 2
    - Error channel 3
    - Us Undervoltage
    - Up Undervoltage
    - Sync error
    - TxPDO Toggle
  - DIG Output Channel 1
  - DIG Output Channel 2
  - DIG Output Channel 3
  - DIG Outputs Device
  - WcState
  - InfoData

#### Data types

- DIG Inputs Device
  - Safe state active: **BIT**
  - Error channel 1: **BIT**
  - Error channel 2: **BIT**
  - Error channel 3: **BIT**
  - Us Undervoltage: **BIT**
  - Up Undervoltage: **BIT**
  - Sync error: **BIT**
  - TxPDO Toggle: **BIT**

#### Safe state active

Indicates whether the safe state has been assumed. The display only works if the network transmits process input data, i.e. in the network states Pre-Operational (PRE-OP) and Operational (OP), but not in the network state INIT.

#### Error channel n

Indicates an error on channel n.

#### Us Undervoltage

Indicates that the voltage  $U_s < \text{approx. } 18V$ .

#### Up Undervoltage

Indicates that the voltage  $U_p < \text{approx. } 18V$ .

#### Sync Error

See EtherCAT system documentation.

#### TxPDO Toggle

See EtherCAT system documentation.

### DIG Outputs Channel n

Under **DIG Outputs Channel 1 - 3** you will find 8 digital outputs of each module.

- ▲ Box 1 (EP2817-0008)
  - ▶ DIG Diag Inputs Channel 1
  - ▶ DIG Diag Inputs Channel 2
  - ▶ DIG Diag Inputs Channel 3
  - ▶ DIG Inputs Device
  - ▲ DIG Output Channel 1
    - ▶ Output 1
    - ▶ Output 2
    - ▶ Output 3
    - ▶ Output 4
    - ▶ Output 5
    - ▶ Output 6
    - ▶ Output 7
    - ▶ Output 8
  - ▶ DIG Output Channel 2
  - ▶ DIG Output Channel 3
  - ▶ DIG Outputs Device
  - ▶ WcState
  - ▶ InfoData

#### Data types













- ▶ DIG Output Channel 1
  - ▶ Output n: **BIT**

The assignment is always made in pairs on the left and right side of the D-SUB connector in order to systematically connect double-switching valves.



<b>Type</b>	Output 2	Output 4	Output 6	Output 8	Output 10	Output 12	Output 14	Output 16	Output 18	Output 20	Output 22	Output 24	
<b>Pin</b>	14	15	16	17	18	19	20	21	22	23	24	25	
<b>Type</b>	Output 1	Output 3	Output 5	Output 7	Output 9	Output 11	Output 13	Output 15	Output 17	Output 19	Output 21	Output 23	GND
<b>Pin</b>	1	2	3	4	5	6	7	8	9	10	11	12	13

**DIG Outputs Device**

You will find the module's control outputs under **DIG Outputs Device**.

- ▶  DIG Diag Inputs Channel 1
    - ▶  DIG Diag Inputs Channel 2
    - ▶  DIG Diag Inputs Channel 3
    - ▶  DIG Inputs Device
    - ▶  DIG Output Channel 1
    - ▶  DIG Output Channel 2
    - ▶  DIG Output Channel 3
    - ▶  DIG Outputs Device
        - ▶  Set safe state
        - ▶  Reset outputs
    - ▶  WcState
    - ▶  InfoData

**Data types**

- ▶  DIG Outputs Device
    - ▶  Set safe state: **BIT**
    - ▶  Reset outputs: **BIT**

**Set safe state**

Sets the module to the safe state.

**Reset outputs**

Resets the error bits "Error channel X" of the module. The outputs are reactivated.

## 3.12 EP2839-0022

### 3.12.1 EP2839-0022 - Introduction

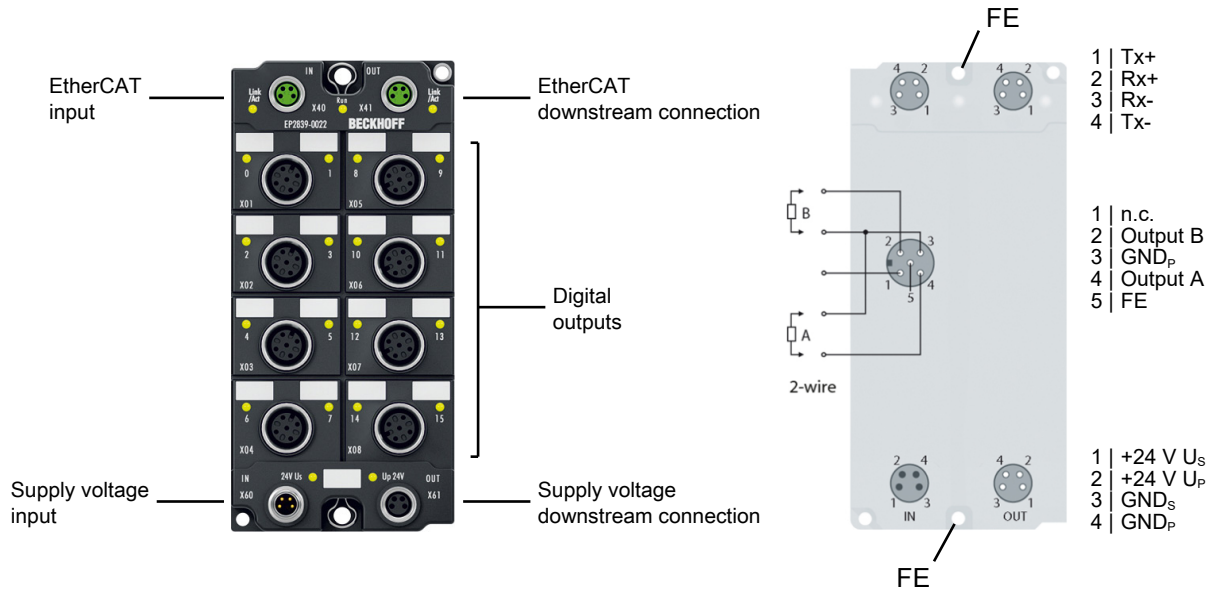

#### 16-channel digital output 24 V<sub>DC</sub> with diagnosis

The EP2839-0022 EtherCAT Box is designed for processing digital/binary signals. It connects the binary control signals from the automation device on to the actuators at the process level. The 16 outputs each handle an output current of up to max. 0.5 A. A short-term overload is possible. The outputs are short-circuit proof. The sum current of all outputs is limited to 4 A. The signal state of the channels is indicated by LEDs. The signal connection is established via screw-type M12 connectors. Two channels are available per M12 socket. Each output channel reports an "Open load" error or short circuit to the PLC via diagnosis. This diagnosis can be switched off channel by channel. Module-related undervoltage detection of the supply voltage takes place. The EP2839-0022 has M8 EtherCAT connections and M8 connectors for the power supply.

Special features:

- Short-circuit and open-load detection per channel
- adjustable diagnosis per channel
- Undervoltage detection

#### Quick links

[Technical data \[▶ 73\]](#)

[Process image \[▶ 75\]](#)

[Dimensions \[▶ 86\]](#)

[Actuator connection \[▶ 106\]](#)



### 3.12.2 EP2839-0022 - Technical data

All values are typical values over the entire temperature range, unless stated otherwise.

EtherCAT	
Connection	2 x M8 socket, 4-pin, A-coded, shielded
Electrical isolation	500 V
Distributed Clocks	yes

Supply voltages	
Connection	Input: M8 connector, 4-pin, A-coded Downstream connection: M8 socket, 4-pin, A-coded
$U_S$ nominal voltage	24 V <sub>DC</sub> (-15 % / +20 %)
$U_S$ sum current: $I_{S,sum}$	max. 4 A
Current consumption from $U_S$	130 mA
Rated voltage $U_P$	24 V <sub>DC</sub> (-15 % / +20 %)
$U_P$ sum current: $I_{P,sum}$	max. 4 A
Current consumption from $U_P$	20 mA + load
Electrical isolation GND <sub>S</sub> / GND <sub>P</sub>	yes

Digital outputs	
Number	16
Connection	8 x M12 socket, 5-pin, A-coded
Load type	Ohmic, inductive, lamp load up to 12 W
Nominal output voltage	24 V <sub>DC</sub>
Output current	max. 0.5 A per channel, individually short-circuit proof. max. 4 A in total.
Output driver supply	From the peripheral voltage $U_P$ .
Changeover times	$T_{ON}$ : 50 μs typ., $T_{OFF}$ : 100 μs typ.
Diagnosis	<ul style="list-style-type: none"> <li>• Short circuit</li> <li>• Open load</li> <li>• Undervoltage</li> </ul>

Housing data	
Dimensions W x H x D	60 mm x 126 mm x 26.5 mm (without plug connectors)
Weight	approx. 250 g
Installation position	variable
Material	PA6 (polyamide)

Environmental conditions	
Ambient temperature during operation	-25 ... +60 °C -25 ... +55 °C according to cURus
Ambient temperature during storage	-40 ... +85 °C
Vibration resistance, shock resistance	conforms to EN 60068-2-6 / EN 60068-2-27 Additional tests [ <a href="#">▶ 74</a> ]
EMC immunity / emission	conforms to EN 61000-6-2 / EN 61000-6-4
Protection class	IP65, IP66, IP67 (conforms to EN 60529)

Approvals/markings	
Approvals/markings <sup>*)</sup>	CE, cURus [ <a href="#">▶ 115</a> ]

\*) Real applicable approvals/markings see type plate on the side (product marking).

### Additional tests

The devices have undergone the following additional tests:

Test	Explanation
Vibration	10 frequency sweeps in 3 axes
	5 Hz < f < 60 Hz displacement 0.35 mm, constant amplitude
	60.1 Hz < f < 500 Hz acceleration 5 g, constant amplitude
Shocks	1000 shocks in each direction, in 3 axes
	35 g, 11 ms

### 3.12.3 EP2839-0022 - Scope of supply

Make sure that the following components are included in the scope of delivery:

- 1x EP2839-0022
- 2x protective cap for EtherCAT socket, M8, green (pre-assembled)
- 1x protective cap for supply voltage input, M8, transparent (pre-assembled)
- 1x protective cap for supply voltage output, M8, black (pre-assembled)
- 10x labels, blank (1 strip of 10)

---

#### **i** Pre-assembled protective caps do not ensure IP67 protection

Protective caps are pre-assembled at the factory to protect connectors during transport. They may not be tight enough to ensure IP67 protection.

Ensure that the protective caps are correctly seated to ensure IP67 protection.

---































### 3.12.4 EP2839-0022 - Process image

#### DO Diagnosis

NOTICE
<p><b>Some diagnostic functions are disabled in the factory setting</b></p> <p>The following errors are only reported if you enable them beforehand:                      "Open load"                      "Short to 24V"</p> <ul style="list-style-type: none"> <li>• See chapter <a href="#">Enable additional diagnostic functions</a> [▶ 126].</li> </ul>













At DO Diagnosis you will find the diagnostic bits of the digital outputs.

If you do not want to evaluate the diagnostic information, you can also remove this process data object from the process image. To do this, select the Predefined PDO Assignment "8DO" instead of "8DO full diagnosis".

- ▲  Box 1 (EP2839-00x2)
  - ▲  DO Diagnosis
    -  Channel 1 X01-4 Overcurrent
    -  Channel 1 X01-4 Overload
    -  Channel 1 X01-4 Open load
    -  Channel 1 X01-4 Short to 24V
    -  Channel 2 X01-2 Overcurrent
    -  Channel 2 X01-2 Overload
    -  Channel 2 X01-2 Open load
    -  Channel 2 X01-2 Short to 24V
    -  Channel 3 X02-4 Overcurrent
    -  Channel 3 X02-4 Overload
    -  Channel 3 X02-4 Open load
    -  Channel 3 X02-4 Short to 24V
  - ⋮
  -  Channel 14 X07-2 Overcurrent
  -  Channel 14 X07-2 Overload
  -  Channel 14 X07-2 Open load
  -  Channel 14 X07-2 Short to 24V
  -  Channel 15 X08-4 Overcurrent
  -  Channel 15 X08-4 Overload
  -  Channel 15 X08-4 Open load
  -  Channel 15 X08-4 Short to 24V
  -  Channel 16 X08-2 Overcurrent
  -  Channel 16 X08-2 Overload
  -  Channel 16 X08-2 Open load
  -  Channel 16 X08-2 Short to 24V
- ▶  DEV Inputs Device
- ▶  DO Outputs
- ▶  WcState
- ▶  InfoData























## DEV Inputs Device

At DEV Inputs Device you will find, among other things, the diagnostic bits of the module.

- ▲  Box 1 (EP2839-00x2)
  - ▷  DO Diagnosis
  - ▲  DEV Inputs Device
    - ▶  Undervoltage Us
    - ▶  Undervoltage Up
    - ▶  Overtemperature
    - ▶  Diag
    - ▶  TxPDO State
    - ▶  Input cycle counter
  - ▷  DO Outputs
  - ▷  WcState
  - ▷  InfoData

## DO Outputs

The digital outputs can be found under DO Outputs.

- ▲  Box 1 (EP2839-00x2)
  - ▷  DO Diagnosis
  - ▷  DEV Inputs Device
  - ▲  DO Outputs
    - ▶  Channel 1 X01-4 Output
    - ▶  Channel 2 X01-2 Output
    - ▶  Channel 3 X02-4 Output
    - ▶  Channel 4 X02-2 Output
    - ▶  Channel 5 X03-4 Output
    - ▶  Channel 6 X03-2 Output
    - ▶  Channel 7 X04-4 Output
    - ▶  Channel 8 X04-2 Output
    - ▶  Channel 9 X05-4 Output
    - ▶  Channel 10 X05-2 Output
    - ▶  Channel 11 X06-4 Output
    - ▶  Channel 12 X06-2 Output
    - ▶  Channel 13 X07-4 Output
    - ▶  Channel 14 X07-2 Output
    - ▶  Channel 15 X08-4 Output
    - ▶  Channel 16 X08-2 Output
  - ▷  WcState
  - ▷  InfoData

### 3.13 EP2839-0042

#### 3.13.1 EP2839-0042 - Introduction

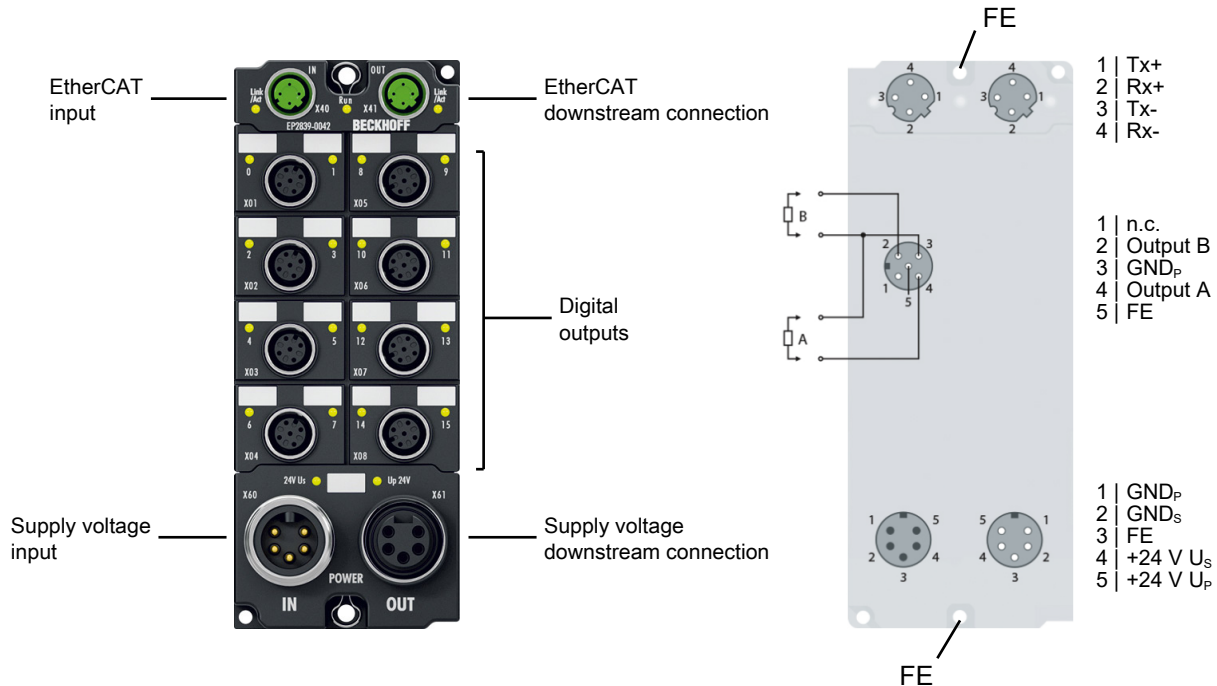

#### 16-channel digital output 24 V<sub>DC</sub> with diagnosis

The EP2839-0042 EtherCAT Box is designed for processing digital/binary signals. It connects the binary control signals from the automation device on to the actuators at the process level. The 16 outputs each handle an output current of up to max. 0.5 A. A short-term overload is possible. The outputs are short-circuit proof. The sum current of all outputs is limited to 16 A. The signal state of the channels is indicated by LEDs. The signal connection is established via screw-type M12 connectors. Two channels are available per M12 socket. Each output channel reports an "Open load" error or short circuit to the PLC via diagnosis. This diagnosis can be switched off channel by channel. Module-related undervoltage detection of the supply voltage takes place. The EP2839-0042 has M12 EtherCAT connections and 7/8-inch connectors for the power supply.

Special features:

- Short-circuit and open-load detection per channel
- adjustable diagnosis per channel
- Undervoltage detection

The EP2839-0042 is interference-free. You can use the EP2839-0042 instead of an interference-free standard terminal in accordance with the following chapters of the [TwinSAFE Application Guide](#):

- "All-pole disconnection of a potential group with downstream interference-free standard terminals (Category 4, PL e)"
- "Single-pole disconnection of a potential group with downstream interference-free standard terminals with fault exclusion (Category 4, PL e)"
- „EL2911 potential group with interference-free standard terminals (Category 4, PL e)"

**Quick links**

[Technical data \[▶ 79\]](#)

[Process image \[▶ 75\]](#)

[Dimensions \[▶ 88\]](#)

[Actuator connection \[▶ 106\]](#)

### 3.13.2 EP2839-0042 - Technical data

All values are typical values over the entire temperature range, unless stated otherwise.

EtherCAT	
Connection	2 x M12 socket, 4-pin, D-coded, shielded
Electrical isolation	500 V
Distributed Clocks	yes

Supply voltages	
Connection	Input: 7/8" plug, 5-pin, 16-UN thread Downstream connection: 7/8" socket, 5-pin, 16-UN thread
U <sub>S</sub> nominal voltage	24 V <sub>DC</sub> (-15 % / +20 %)
U <sub>S</sub> sum current	max. 16 A at 40 °C
Current consumption from U <sub>S</sub>	130 mA
Rated voltage U <sub>P</sub>	24 V <sub>DC</sub> (-15 % / +20 %)
U <sub>P</sub> sum current	max. 16 A at 40 °C
Current consumption from U <sub>P</sub>	20 mA + load
Electrical isolation GND <sub>S</sub> / GND <sub>P</sub>	yes

Digital outputs	
Number	16
Connection	8 x M12 socket, 5-pin, A-coded
Load type	Ohmic, inductive, lamp load up to 12 W
Nominal output voltage	24 V <sub>DC</sub>
Output current	max. 0.5 A per channel, individually short-circuit proof.
Output driver supply	From the peripheral voltage U <sub>P</sub>
Changeover times	T <sub>ON</sub> : 50 µs typ., T <sub>OFF</sub> : 100 µs typ.
Diagnosis	<ul style="list-style-type: none"> <li>• Short circuit</li> <li>• Open load</li> <li>• Undervoltage</li> </ul>

Housing data	
Dimensions W x H x D	60 mm x 150 mm x 26,5 mm (without connectors)
Weight	approx. 440 g
Installation position	variable
Material	PA6 (polyamide)

Environmental conditions	
Ambient temperature during operation	-25 ... +60 °C -25 ... +55 °C according to cURus
Ambient temperature during storage	-40 ... +85 °C
Vibration resistance, shock resistance	conforms to EN 60068-2-6 / EN 60068-2-27 <a href="#">Additional tests [► 80]</a>
EMC immunity / emission	conforms to EN 61000-6-2 / EN 61000-6-4
Protection class	IP65, IP66, IP67 (conforms to EN 60529)

Approvals / markings	
Approvals / markings *)	CE, UL under preparation

\*) Real applicable approvals/markings see type plate on the side (product marking).

**Additional tests**

The devices have undergone the following additional tests:

Test	Explanation
Vibration	10 frequency sweeps in 3 axes
	5 Hz < f < 60 Hz displacement 0.35 mm, constant amplitude
	60.1 Hz < f < 500 Hz acceleration 5 g, constant amplitude
Shocks	1000 shocks in each direction, in 3 axes
	35 g, 11 ms

**3.13.3 EP2839-0042 - Scope of supply**

Make sure that the following components are included in the scope of delivery:

- 1x EP2839-0042
- 2x protective cap for EtherCAT socket, M12 (pre-assembled)
- 1x Protective cap for supply voltage output, 7/8", black (pre-fitted)
- 10x labels, blank (1 strip of 10)

**Pre-assembled protective caps do not ensure IP67 protection**

Protective caps are pre-assembled at the factory to protect connectors during transport. They may not be tight enough to ensure IP67 protection.

Ensure that the protective caps are correctly seated to ensure IP67 protection.

































### 3.13.4 EP2839-0042 - Process image

#### DO Diagnosis

NOTICE
<p><b>Some diagnostic functions are disabled in the factory setting</b></p> <p>The following errors are only reported if you enable them beforehand:                      "Open load"                      "Short to 24V"</p> <ul style="list-style-type: none"> <li>• See chapter <a href="#">Enable additional diagnostic functions</a> [► 126].</li> </ul>













At DO Diagnosis you will find the diagnostic bits of the digital outputs.

If you do not want to evaluate the diagnostic information, you can also remove this process data object from the process image. To do this, select the Predefined PDO Assignment "8DO" instead of "8DO full diagnosis".

- ▲  Box 1 (EP2839-00x2)
  - ▲  DO Diagnosis
    -  Channel 1 X01-4 Overcurrent
    -  Channel 1 X01-4 Overload
    -  Channel 1 X01-4 Open load
    -  Channel 1 X01-4 Short to 24V
    -  Channel 2 X01-2 Overcurrent
    -  Channel 2 X01-2 Overload
    -  Channel 2 X01-2 Open load
    -  Channel 2 X01-2 Short to 24V
    -  Channel 3 X02-4 Overcurrent
    -  Channel 3 X02-4 Overload
    -  Channel 3 X02-4 Open load
    -  Channel 3 X02-4 Short to 24V
  - ⋮
  -  Channel 14 X07-2 Overcurrent
  -  Channel 14 X07-2 Overload
  -  Channel 14 X07-2 Open load
  -  Channel 14 X07-2 Short to 24V
  -  Channel 15 X08-4 Overcurrent
  -  Channel 15 X08-4 Overload
  -  Channel 15 X08-4 Open load
  -  Channel 15 X08-4 Short to 24V
  -  Channel 16 X08-2 Overcurrent
  -  Channel 16 X08-2 Overload
  -  Channel 16 X08-2 Open load
  -  Channel 16 X08-2 Short to 24V
- ▷  DEV Inputs Device
- ▷  DO Outputs
- ▷  WcState
- ▷  InfoData























## DEV Inputs Device

At DEV Inputs Device you will find, among other things, the diagnostic bits of the module.

- ▲  Box 1 (EP2839-00x2)
  - ▷  DO Diagnosis
  - ▲  DEV Inputs Device
    - ▶  Undervoltage Us
    - ▶  Undervoltage Up
    - ▶  Overtemperature
    - ▶  Diag
    - ▶  TxPDO State
    - ▶  Input cycle counter
  - ▷  DO Outputs
  - ▷  WcState
  - ▷  InfoData

## DO Outputs

The digital outputs can be found under DO Outputs.

- ▲  Box 1 (EP2839-00x2)
  - ▷  DO Diagnosis
  - ▷  DEV Inputs Device
  - ▲  DO Outputs
    - ▶  Channel 1 X01-4 Output
    - ▶  Channel 2 X01-2 Output
    - ▶  Channel 3 X02-4 Output
    - ▶  Channel 4 X02-2 Output
    - ▶  Channel 5 X03-4 Output
    - ▶  Channel 6 X03-2 Output
    - ▶  Channel 7 X04-4 Output
    - ▶  Channel 8 X04-2 Output
    - ▶  Channel 9 X05-4 Output
    - ▶  Channel 10 X05-2 Output
    - ▶  Channel 11 X06-4 Output
    - ▶  Channel 12 X06-2 Output
    - ▶  Channel 13 X07-4 Output
    - ▶  Channel 14 X07-2 Output
    - ▶  Channel 15 X08-4 Output
    - ▶  Channel 16 X08-2 Output
  - ▷  WcState
  - ▷  InfoData

## 4 Basic Function Principles

### 4.1 Overload protection

#### Lamp loads

When switching on lamp loads, high starting currents occur that are limited by the output circuit.

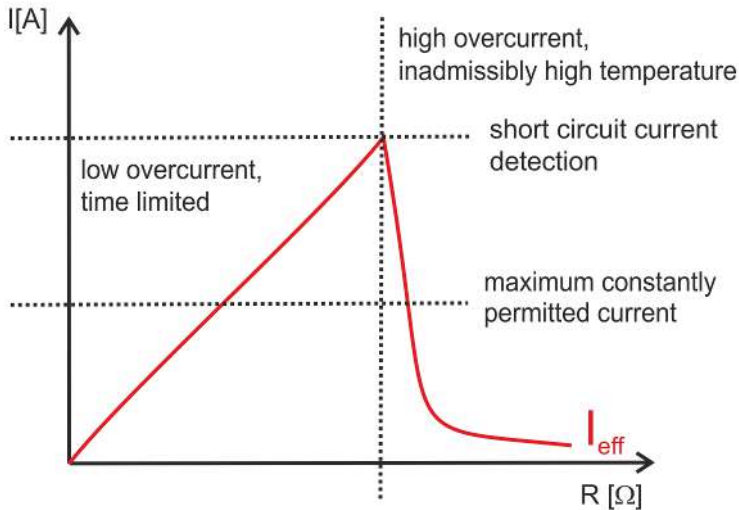

#### Inductive loads

When switching off inductive loads, high induction voltages result from interrupting the current too quickly. These are limited by an integrated free-wheeling. Since the current reduces only slowly, a delayed switch-off can occur in many control applications. For example, a valve remains open for many milliseconds. Switch-off times are realized that correspond, for instance, to the switch-on time of the coil.

#### **i** Protection against high induction voltages

To protect against voltage peaks such as can occur when switching inductive loads, we recommend to provide suitable protective circuits (e.g. with the free-wheeling diode, RC combination or varistor) directly at the actuator.

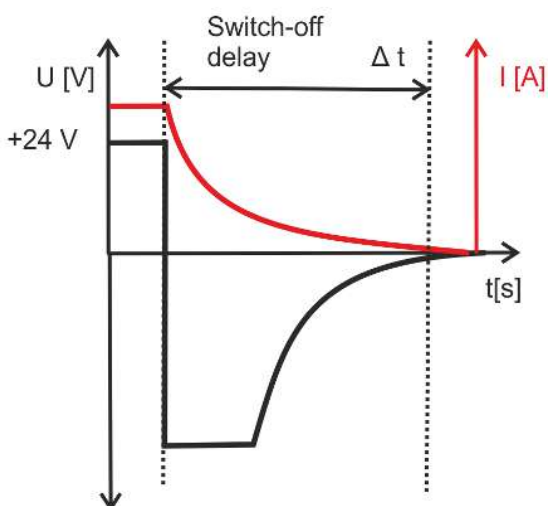

**Thermal shutdown**

In case of a long-term overload and/or short-circuit, the output is protected by the thermal shutdown of the channel.

The output circuit limits the current. It maintains this current until the channel is strongly self-heating.

If the upper limit temperature is exceeded, the channel is switched off.

After the channel has cooled down to the lower limit value of the temperature, the channel is switched on again.

The output signal is clocked until the output is switched off by the controller or the short circuit is eliminated.

The clock frequency depends on the ambient temperature and the loads on the other channels.

Short circuit or prolonged overload on one channel leads to an increase in the device temperature. If several channels are overloaded, this leads to a rapid increase in the device temperature. The overloaded channels are switched off when the upper limit for the device temperature is exceeded. The channels are only switched on again if the temperature falls below the lower limit values for both the device and the channel. The non-overloaded channels continue operating properly.

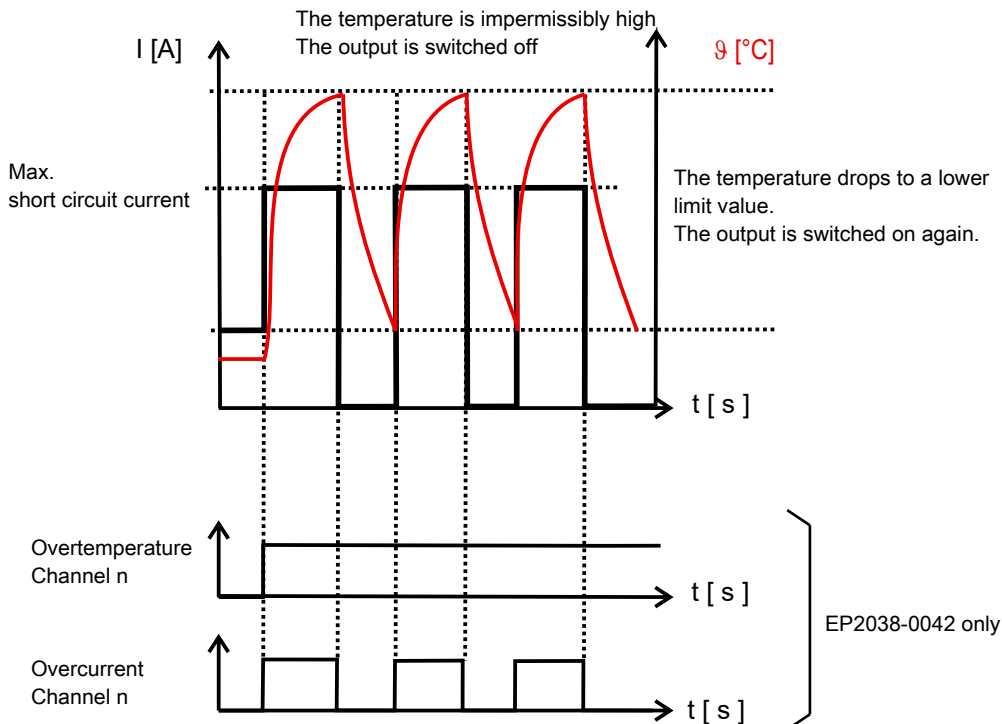

## 5 Mounting and connection

### 5.1 Mounting

#### 5.1.1 Dimensions EPxxxx-xx0x and EPxxxx-xx1x

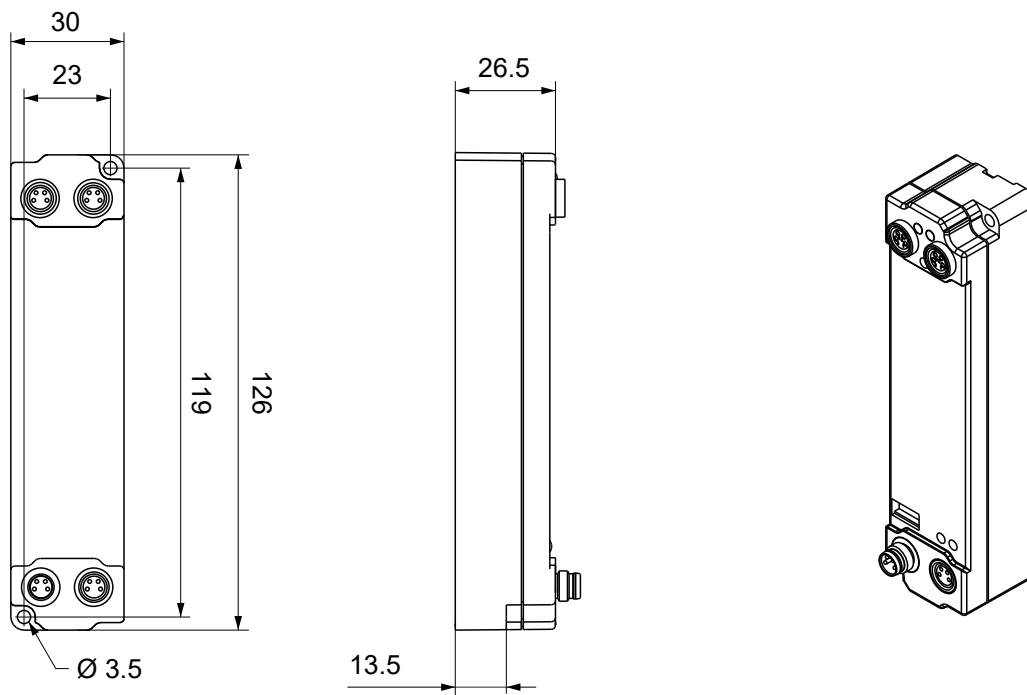

All dimensions are given in millimeters.  
The drawing is not true to scale.

#### Housing features

Housing material	PA6 (polyamide)
Sealing compound	polyurethane
Mounting	two mounting holes Ø 3.5 mm for M3
Metal parts	brass, nickel-plated
Contacts	CuZn, gold-plated
Power feed through	max. 4 A
Installation position	variable
Protection class	IP65, IP66, IP67 (conforms to EN 60529) when screwed together
Dimensions (H x W x D)	approx. 126 x 30 x 26.5 mm (without connectors)

## 5.1.2 Dimensions EPxxxx-xx2x

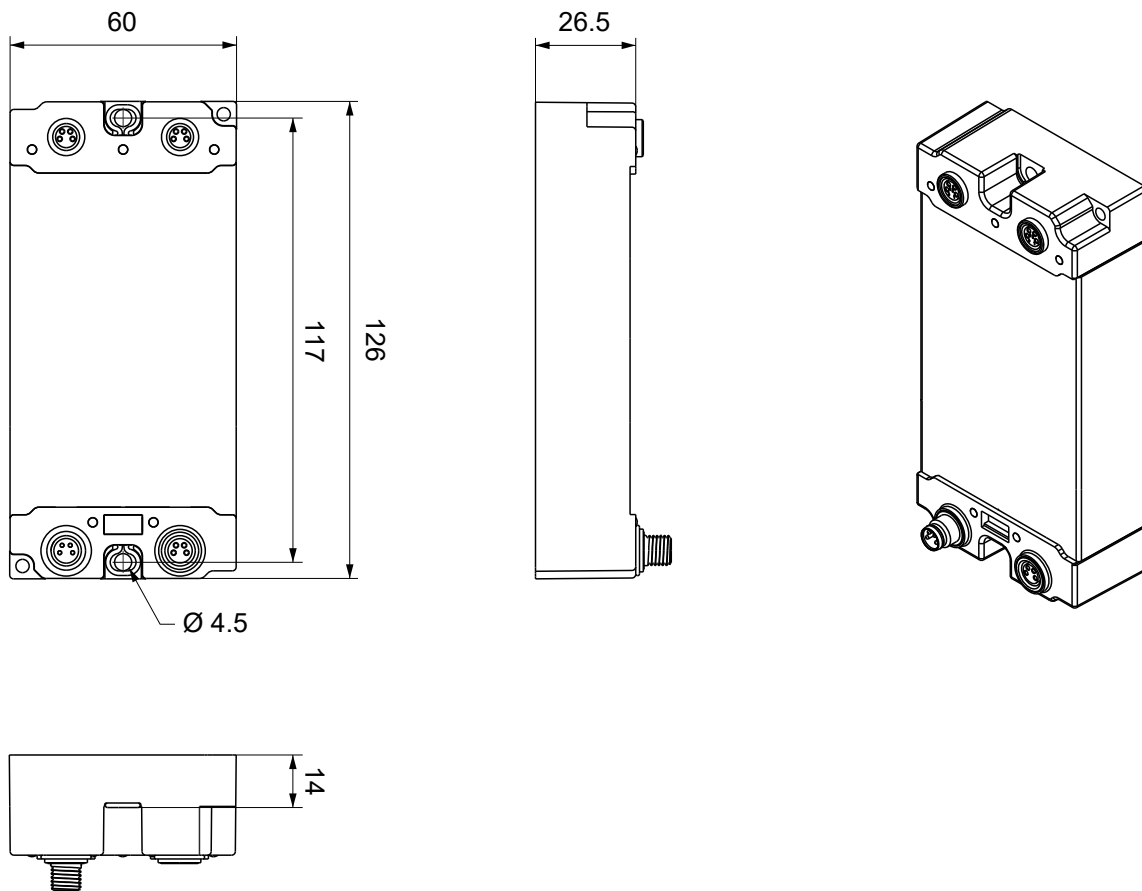

All dimensions are given in millimeters.  
The drawing is not true to scale.

### Housing features

Housing material	PA6 (polyamide)
Sealing compound	polyurethane
Mounting	two mounting holes Ø 4.5 mm for M4
Metal parts	brass, nickel-plated
Contacts	CuZn, gold-plated
Installation position	variable
Protection class	IP65, IP66, IP67 (conforms to EN 60529) when screwed together
Dimensions (H x W x D)	approx. 126 x 60 x 26.5 mm (without connectors)

**5.1.3 EPxxxx-xx32 dimensions**

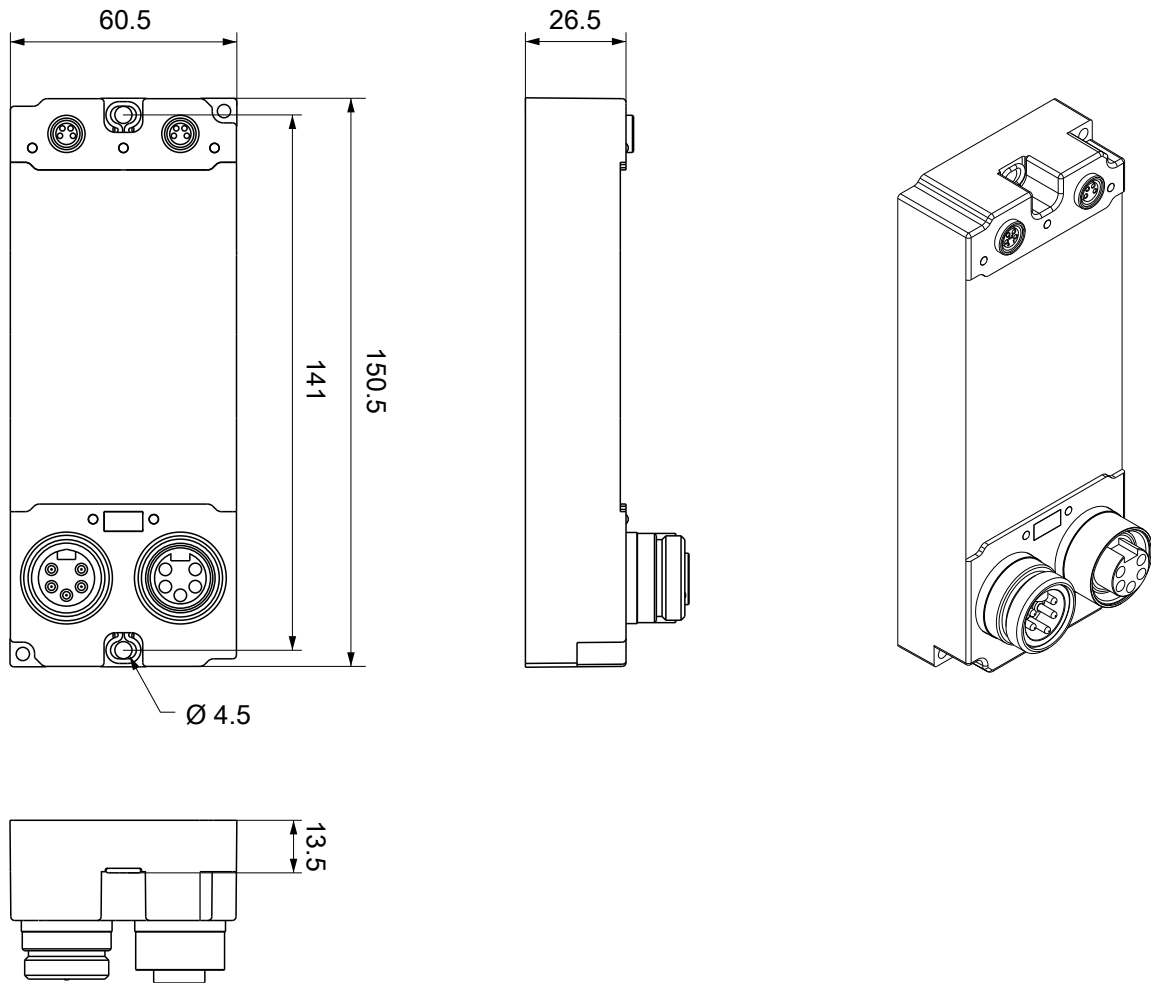

All dimensions are given in millimeters.  
The drawing is not true to scale.

**Housing features**

Housing material	PA6 (polyamide)
Sealing compound	polyurethane
Mounting	two mounting holes $\varnothing 4.5$ mm for M4
Metal parts	brass, nickel-plated
Contacts	CuZn, gold-plated
Power feed through	max. 16 A at 40°C (according to IEC 60512-3)
Installation position	variable
Protection class	IP65, IP66, IP67 (conforms to EN 60529) when screwed together
Dimensions (H x W x D)	approx. 150 x 60 x 26.5 mm (without connectors)

### 5.1.4 EPxxx-xx42 dimensions

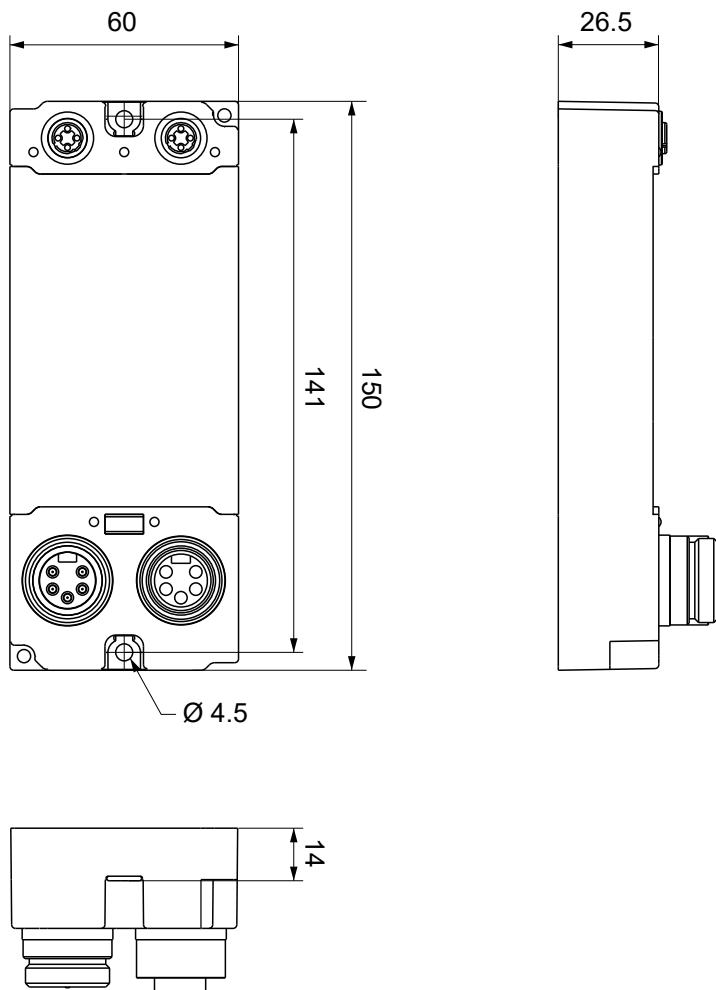

All dimensions are given in millimeters.  
The drawing is not true to scale.

#### Housing features

Housing material	PA6 (polyamide)
Sealing compound	polyurethane
Mounting	two mounting holes Ø 4.5 mm for M4
Metal parts	brass, nickel-plated
Contacts	CuZn, gold-plated
Power feed through	max. 16 A at 40°C (according to IEC 60512-3)
Installation position	variable
Protection class	IP65, IP66, IP67 (conforms to EN 60529) when screwed together
Dimensions (H x W x D)	approx. 150 x 60 x 26.5 mm (without connectors)



## 5.1.5 Fixing

### ● Protection of connectors against contamination!

**i** While mounting the modules, protect all connectors, against contamination! Only with connected cables or plugs the protection class IP67 is guaranteed! Unused connectors have to be protected with the right plugs! See for plug sets in the catalogue.

Modules with narrow housing are mounted with two M3 bolts.

Modules with wide housing are mounted with two M3 bolts to the mounting holes located at the corners or mounted with two M4 bolts to the mounting holes located centrally.

The bolts must be longer than 15 mm. The mounting holes of the modules are not threaded.

When assembling, remember that the fieldbus connectors increases the overall height. See chapter accessories.

### Mounting Rail ZS5300-0001

The mounting rail ZS5300-0001 (500 mm x 129 mm) allows the time saving assembly of modules.

The rail is made of stainless steel, 1.5 mm thick, with already pre-made M3 threads for the modules. The rail has got 5.3 mm slots to mount it via M5 screws to the machine.

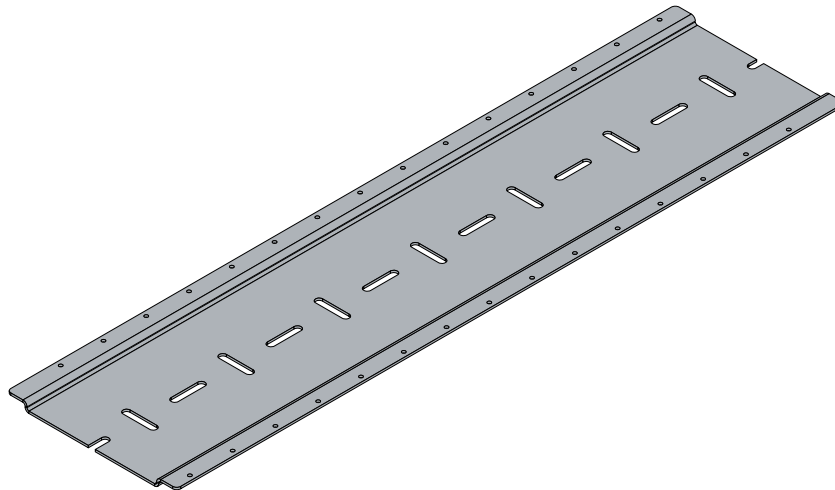

Fig. 5: Mounting Rail ZS5300-000

The mounting rail is 500 mm long, that way 15 narrow modules can be mounted with a distance of 2 mm between two modules. The rail can be cut to length for the application.

### Mounting Rail ZS5300-0011

The mounting rail ZS5300-0011 (500 mm x 129 mm) has in addition to the M3 treads also pre-made M4 treads to fix 60 mm wide modules via their middle holes.

Up to 14 narrow or 7 wide modules may be mixed mounted.

### 5.1.6 Functional earth (FE)

EtherCAT Box modules of types EPxxxx-002x and EPxxxx-0042 must be grounded:

The Fixing also serve as connections for the functional earth (FE).

Make sure that the box is earthed with low impedance via both fastening screws. You can achieve this, for example, by mounting the box on a grounded machine bed.

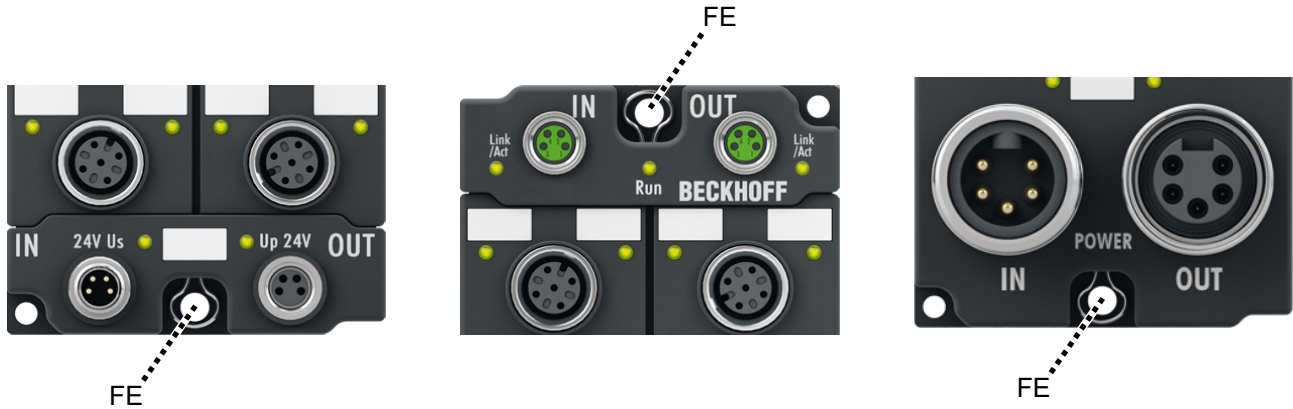

Fig. 6: Functional earth via the fastening holes

## 5.2 Connections

### 5.2.1 Tightening torques for plug connectors

Screw connectors tight with a torque wrench. (e.g. ZB8801 from Beckhoff)

Connector diameter	Tightening torque
M8	0.4 Nm
M12	0.6 Nm
7/8"	1.5 Nm

### 5.2.2 Protective caps

- Seal unused connectors with protective caps.
- Ensure the correct seating of pre-assembled protective caps.  
Protective caps are pre-assembled at the factory to protect connectors during transport. They may not be tight enough to ensure IP67 protection.

## 5.2.3 EtherCAT

### 5.2.3.1 Connectors

**NOTICE**

**Risk of confusion: supply voltages and EtherCAT**

Defect possible through incorrect insertion.

- Observe the color coding of the connectors:  
 black: Supply voltages  
 green: EtherCAT

EtherCAT Box modules have two green M8 or M12 sockets for the incoming and outgoing EtherCAT connections.

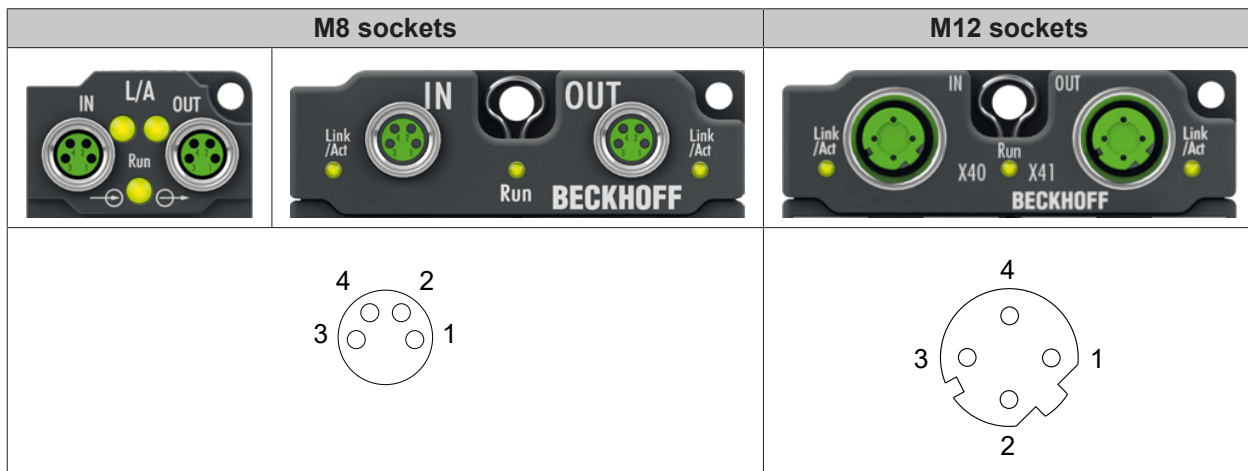

#### Assignment

There are various different standards for the assignment and colors of connectors and cables for EtherCAT.

EtherCAT	Plug connector			Cable		Standard
	M8	M12	RJ45 <sup>1</sup>	ZB9010, ZB9020, ZB9030, ZB9032, ZK1090-6292, ZK1090-3xxx-xxxx	ZB9031 and old versions of ZB9030, ZB9032, ZK1090-3xxx-xxxx	
Signal						TIA-568B
Tx +	Pin 1	Pin 1	Pin 1	yellow <sup>2</sup>	orange/white <sup>3</sup>	white/orange
Tx -	Pin 4	Pin 3	Pin 2	orange <sup>2</sup>	orange <sup>3</sup>	orange
Rx +	Pin 2	Pin 2	Pin 3	white <sup>2</sup>	blue/white <sup>3</sup>	white/green
Rx -	Pin 3	Pin 4	Pin 6	blue <sup>2</sup>	blue <sup>3</sup>	green
Shield	Housing		Shroud	Shield	Shield	Shield

<sup>1</sup>) colored markings according to EN 61918 in the four-pin RJ45 connector ZS1090-0003

<sup>2</sup>) wire colors according to EN 61918

<sup>3</sup>) wire colors

**i Assimilation of color coding for cable ZB9030, ZB9032 and ZK1090-3xxxx-xxxx (with M8 connectors)**

For unification, the prevalent cables ZB9030, ZB9032 and ZK1090-3xxx-xxxx were changed to the colors of EN61918 (yellow, orange, white, blue). So different color coding exists. But the electrical properties are absolutely identical.

**5.2.3.2 Status LEDs**



**L/A (Link/Act)**

A green LED labelled "L/A" is located next to each EtherCAT socket. The LED indicates the communication state of the respective socket:

LED	Meaning
off	no connection to the connected EtherCAT device
lit	LINK: connection to the connected EtherCAT device
flashes	ACT: communication with the connected EtherCAT device

**Run**

Each EtherCAT slave has a green LED labelled "Run". The LED signals the status of the slave in the EtherCAT network:

LED	Meaning
off	Slave is in "Init" state
flashes uniformly	Slave is in "Pre-Operational" state
flashes sporadically	Slave is in "Safe-Operational" state
lit	Slave is in "Operational" state

Description of the EtherCAT slave states

**5.2.3.3 Cables**

For connecting EtherCAT devices only shielded Ethernet cables that meet the requirements of at least category 5 (CAT5) according to EN 50173 or ISO/IEC 11801 should be used.

EtherCAT uses four wires for signal transmission.

Thanks to automatic line detection ("Auto MDI-X"), both symmetrical (1:1) or cross-over cables can be used between Beckhoff EtherCAT.

Detailed recommendations for the cabling of EtherCAT devices

## 5.2.4 Supply voltages

### ⚠ WARNING

#### Power supply from SELV/PELV power supply unit!

SELV/PELV circuits (Safety Extra Low Voltage, Protective Extra Low Voltage) according to IEC 61010-2-201 must be used to supply this device.

Notes:

- SELV/PELV circuits may give rise to further requirements from standards such as IEC 60204-1 et al, for example with regard to cable spacing and insulation.
- A SELV (Safety Extra Low Voltage) supply provides safe electrical isolation and limitation of the voltage without a connection to the protective conductor, a PELV (Protective Extra Low Voltage) supply also requires a safe connection to the protective conductor.

### ⚠ CAUTION

#### Observe the UL requirements

- When operating under UL conditions, observe the warnings in the chapter [UL Requirements](#) [▶ 115].

The EtherCAT Box has one input for two supply voltages:

- **Control voltage  $U_s$**   
The following sub-functions are supplied from the control voltage  $U_s$ :
  - the fieldbus
  - the processor logic
  - typically the inputs and the sensors if the EtherCAT Box has inputs.
- **Peripheral voltage  $U_p$**   
For EtherCAT Box modules with digital outputs the digital outputs are typically supplied from the peripheral voltage  $U_p$ .  $U_p$  can be supplied separately. If  $U_p$  is switched off, the fieldbus function, the function of the inputs and the supply of the sensors are maintained.

The exact assignment of  $U_s$  and  $U_p$  can be found in the pin assignment of the I/O connections.

#### Redirection of the supply voltages

The power IN and OUT connections are bridged in the module. Hence, the supply voltages  $U_s$  and  $U_p$  can be passed from EtherCAT Box to EtherCAT Box in a simple manner.

### NOTICE

#### Note the maximum current!

Ensure that the permitted current for the connectors is not exceeded when routing the supply voltages  $U_s$  and  $U_p$ :

M8 connector: max. 4 A  
7/8" connector: max 16 A





### NOTICE

#### Unintentional cancellation of the electrical isolation possible

In some types of EtherCAT Box modules the ground potentials  $GND_s$  and  $GND_p$  are connected.

- If several EtherCAT Box modules are supplied with the same electrically isolated voltages, check whether there is an EtherCAT Box among them in which the ground potentials are connected.

**5.2.4.1 Connectors**

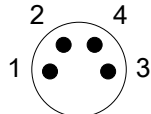
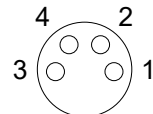
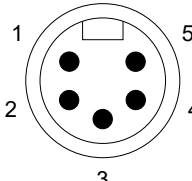
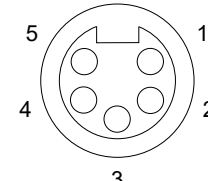
M8 connector		7/8" connector	
			
 <p>Plug Input</p>	 <p>Socket Forwarding</p>	 <p>Plug Feed-in</p>	 <p>Socket Forwarding</p>

Function	M8	7/8"	Description	Core color <sup>1)</sup>
U <sub>s</sub>	1	4	Control voltage	Brown
U <sub>p</sub>	2	5	Peripheral voltage	White
GND <sub>s</sub>	3	2	GND to U <sub>s</sub>	Blue
GND <sub>p</sub>	4	1	GND to U <sub>p</sub>	Black
FE	-	3	Functional earth	Grey

<sup>1)</sup> The core colors apply to cables of the type: Beckhoff ZK2020-xxxx-xxxx

In some modules, GND<sub>s</sub> and GND<sub>p</sub> are connected, in others they are separate. See Technical data of the respective module.

### 5.2.4.2 Status LEDs

Two LEDs indicate the status of the supply voltages.



Fig. 7: Status LEDs for the supply voltages

#### LED $U_s$

Display	Meaning
off	The supply voltage $U_s$ is not available.
green illuminated	The supply voltage $U_s$ is available.
red illuminated	Several possibilities: <ul style="list-style-type: none"> <li>• Undervoltage of the supply voltage <math>U_s</math> (EP2038-0042 only)</li> <li>• Overload on at least one auxiliary voltage output.</li> </ul> As a result, all auxiliary voltage outputs were switched off.

#### LED $U_p$

Display	Meaning
off	The supply voltage $U_p$ is not available
green illuminated	The supply voltage $U_p$ is available
red illuminated (EP2038-0042 only)	Undervoltage of the supply voltage $U_p$ . As a result, all digital outputs were switched off.



### 5.2.4.3 Conductor losses

Take into account the voltage drop on the supply line when planning a system. Avoid the voltage drop being so high that the supply voltage at the box lies below the minimum nominal voltage. Variations in the voltage of the power supply unit must also be taken into account.

#### Voltage drop on cables with M8 connectors

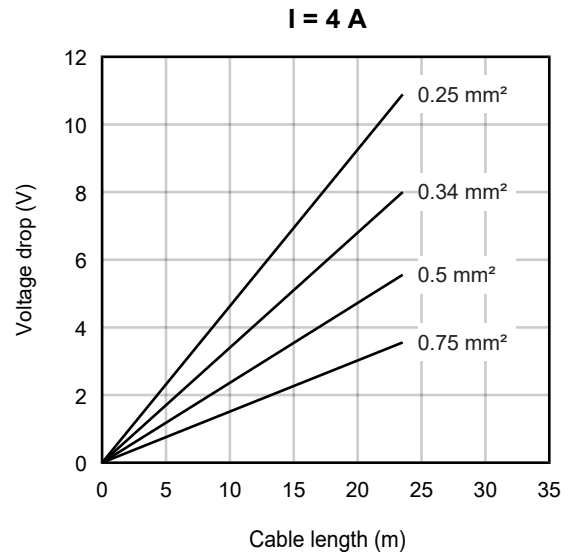
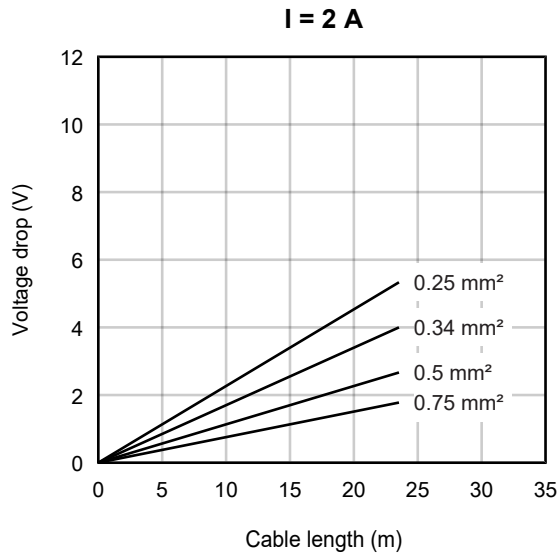

#### Voltage drop on cables with 7/8" connectors

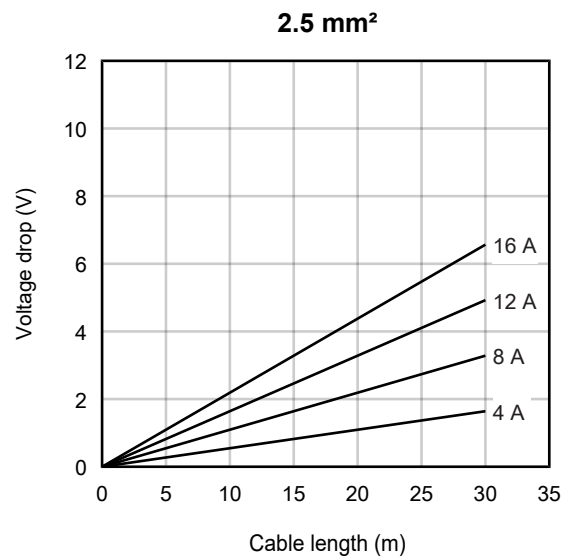
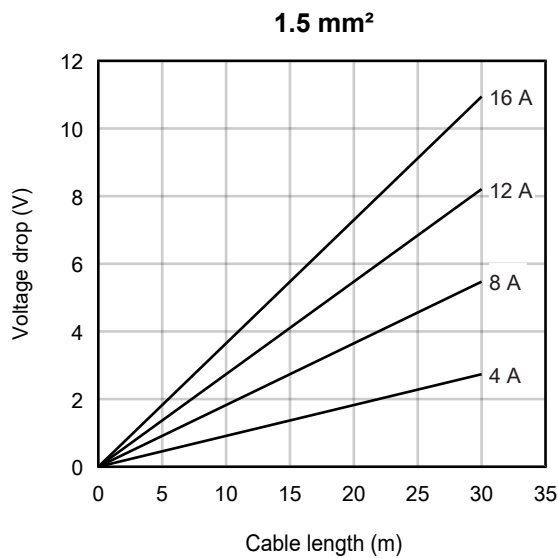

## 5.2.5 Digital outputs

### 5.2.5.1 M8 sockets

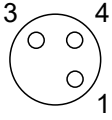

#### EP2xxx-0001 pin assignment

Pin	Function	Core color <sup>1)</sup>
1	+24 V <sub>DC</sub> U <sub>S</sub>	brown
3	GND	blue
4	Output	black

#### EP2xxx-0021 pin assignment

Pin	Function	Core color <sup>1)</sup>
1	+24 V <sub>DC</sub> U <sub>P</sub>	brown
3	GND <sub>P</sub>	blue
4	Output	black

<sup>1)</sup> The core colors apply to sensor cables from Beckhoff. See chapter [Accessories](#) [▶ 210].

#### Connection examples

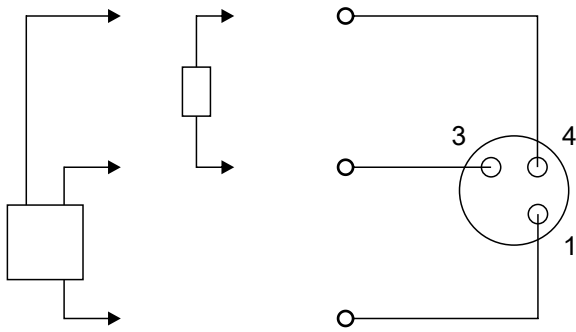

3-wire

2-wire

#### Status LEDs

Next to each M8 socket there is a green LED. The LED lights up when the digital output is switched on.



**5.2.5.2 M12 sockets**

**NOTICE**

**Deviating M12 pin assignments**

The pin assignment shown in this chapter does not apply to all products with M12 sockets.

- Please note the different pin assignments for the following products:

[EP2008-0022](#) [▶ 101]

[EP2028-0032](#) [▶ 102]

[EP2038-0042](#) [▶ 104]

[EP2839x00-2](#) [▶ 106]

**Pin assignment**

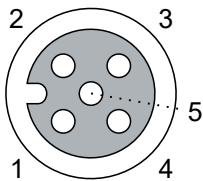

Pin	Function	Core color <sup>1)</sup>
1	+24 V <sub>DC</sub> U <sub>S</sub>	brown
2	Output B	white
3	GND	blue
4	Output A	black
5	-	gray

<sup>1)</sup> The core colors apply to sensor cables from Beckhoff. See chapter [Accessories](#) [▶ 210].

**Connection examples**

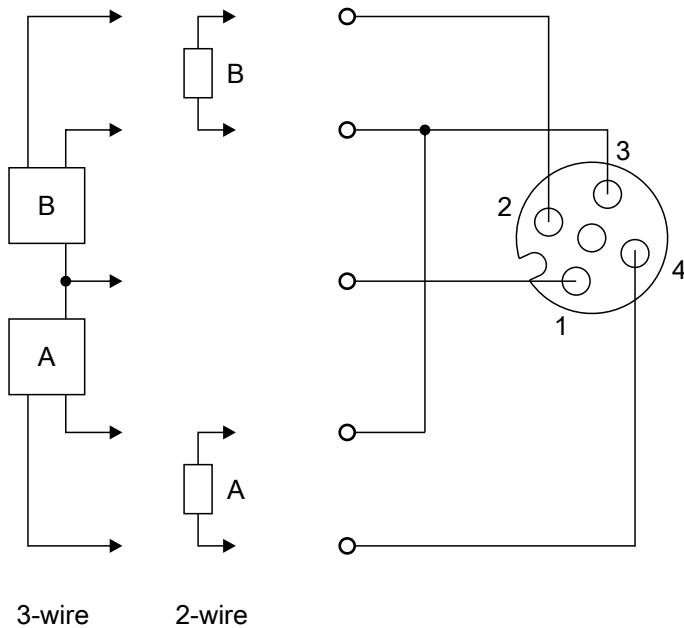

**Status LEDs**

There are two green LEDs next to each M12 socket. An LED lights up when the respective digital output is switched on.

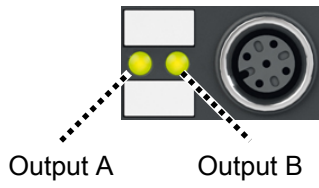

**5.2.5.3 M12 sockets of EP2008-0022**

**Pin assignment**

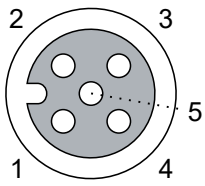

Pin	Function	Core color <sup>1)</sup>
1	+24 V <sub>DC</sub> U <sub>P</sub>	brown
2	-	white
3	GND <sub>P</sub>	blue
4	Output	black
5	-	gray

<sup>1)</sup> The core colors apply to sensor cables from Beckhoff. See chapter [Accessories \[▶ 210\]](#).

**Connection examples**

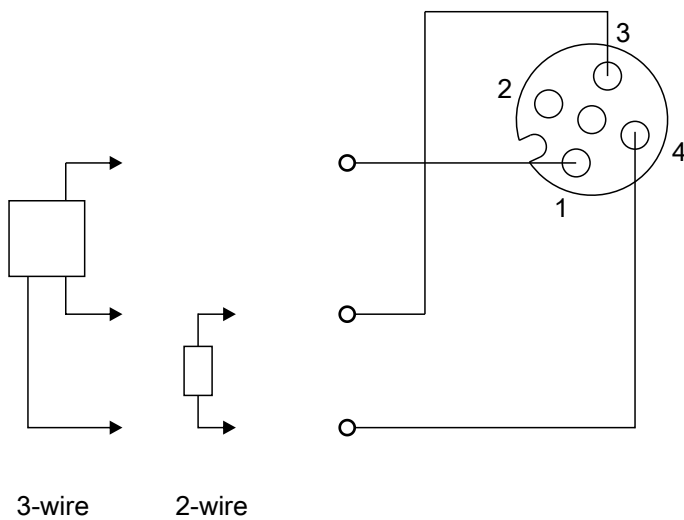

**Status LEDs**

There is a green LED next to each M12 socket. The LED lights up when the digital output is switched on.



### 5.2.5.4 M12 sockets of EP2028-0032

#### Pin assignment

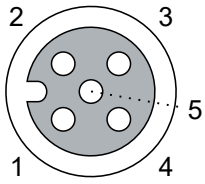

Pin	Function	Core color <sup>1)</sup>
1	+24 V <sub>DC</sub> U <sub>P</sub>	brown
2	(output of an adjacent socket)	white
3	GND <sub>P</sub>	blue
4	Output	black
5	FE	gray

<sup>1)</sup> The core colors apply to sensor cables from Beckhoff. See chapter [Accessories](#) [► 210].

Pins 2 and 4 of the following sockets are each internally connected:

- X01 and X02
- X03 and X04
- X05 and X06
- X07 and X08

Taking the example of X01 and X02:

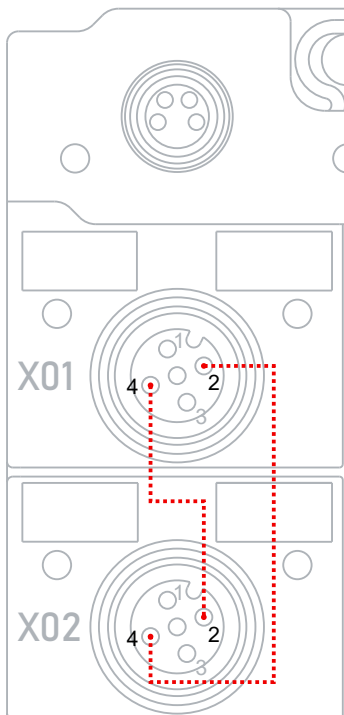

See [connection examples](#) [► 103].

**Connection examples**

Two actuators with two cables

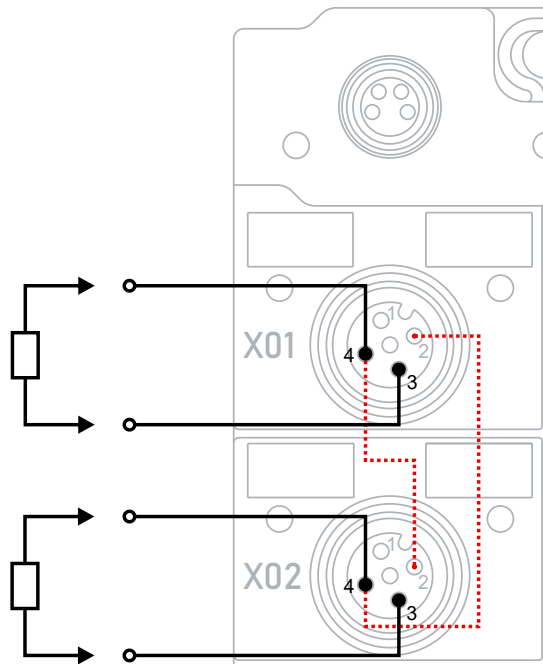

Two actuators with only one cable

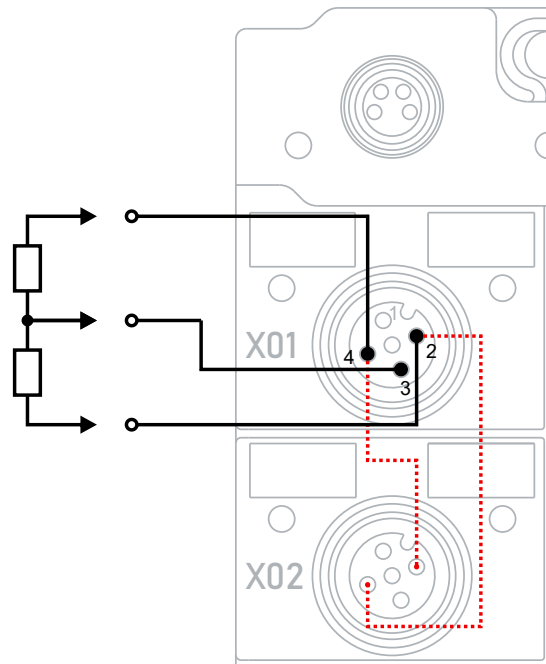

— external connections  
 ..... internal connections

**Status LEDs**

There is a green LED next to each M12 socket. The LED lights up when the digital output is switched on.



### 5.2.5.5 M12 sockets of EP2038-0042

#### Pin assignment

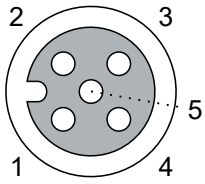

Pin	Function	Core color <sup>1)</sup>
1	-	brown
2	-	white
3	GND <sub>P</sub>	blue
4	Output	black
5	FE	gray

<sup>1)</sup> The core colors apply to sensor cables from Beckhoff. See chapter [Accessories](#) [► 210].

#### Connection example

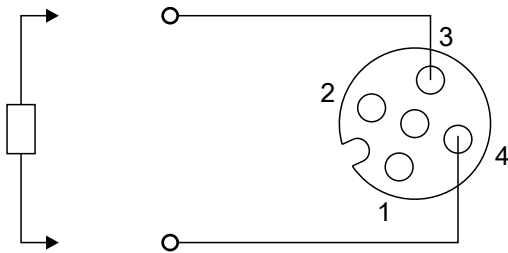

#### Status LEDs

There is a status LED next to each M12 socket.



Signal	Meaning
Off	The output is switched off.
Lights up green	The output is switched on.
Lights up red	Error. Check the diagnostic bits of the affected channel. See chapter Diagnostics per channel.



**5.2.5.6 EP2809-0042 M12 sockets**

**Pin assignment**

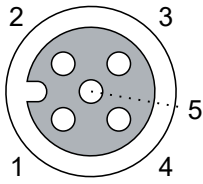

Pin	Function	Core color <sup>1)</sup>
1	+24 VDC U <sub>P</sub>	brown
2	Output B	white
3	GND	blue
4	Output A	black
5	FE	gray

<sup>1)</sup> The core colors apply to sensor cables from Beckhoff. See chapter [Accessories](#) [▶ 210].

**Connection examples**

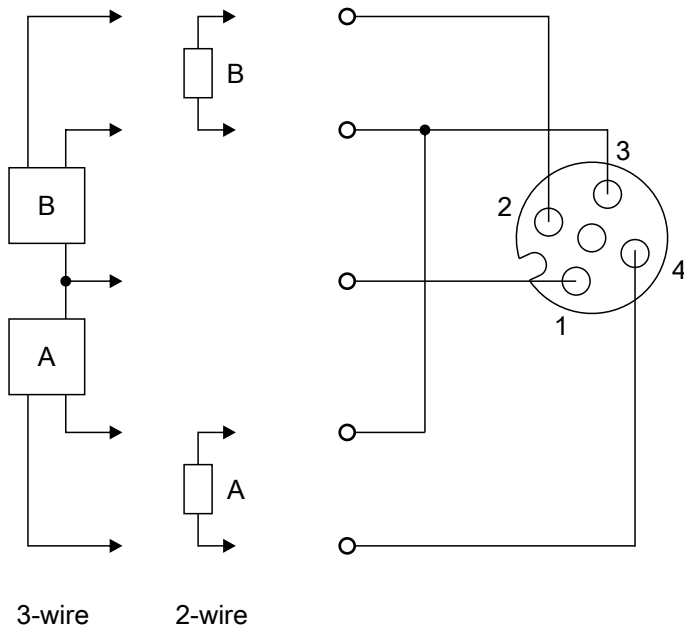

**Status LEDs**

There are two green LEDs next to each M12 socket. An LED lights up when the respective digital output is switched on.

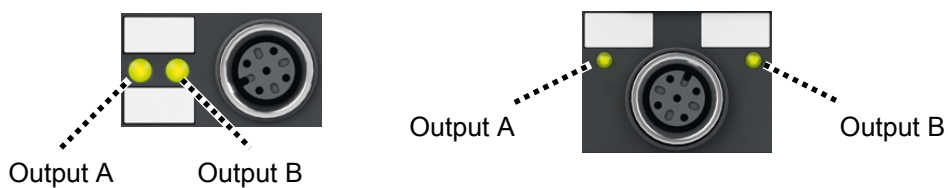

### 5.2.5.7 M12 sockets of EP2839-00x2

#### Pin assignment

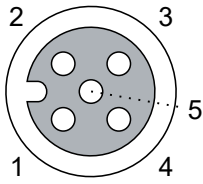

Pin	Function	Core color <sup>1)</sup>
1	-	brown
2	Output B	white
3	GND <sub>P</sub>	blue
4	Output A	black
5	FE	gray

<sup>1)</sup> The core colors apply to sensor cables from Beckhoff. See chapter [Accessories](#) [► 210].

#### Connection examples

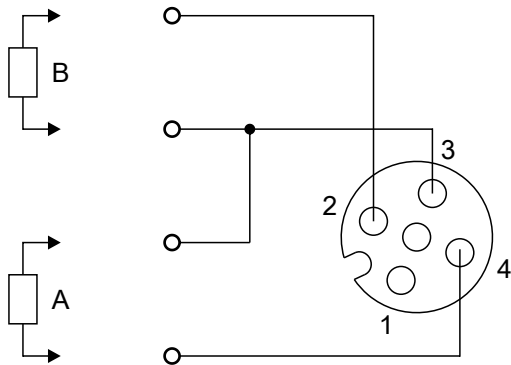

#### Status LEDs

There are two green LEDs next to each M12 socket. An LED lights up when the respective digital output is switched on.



**5.2.5.8 ZS2001**

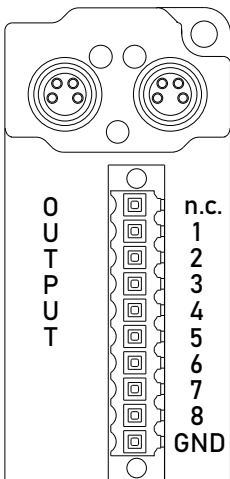

EP2816-0003

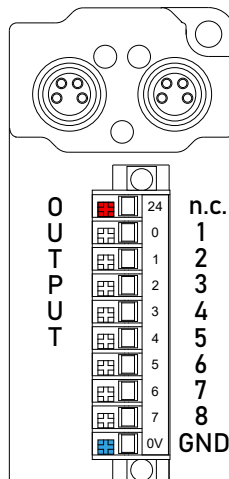

... with ZS2001-0001

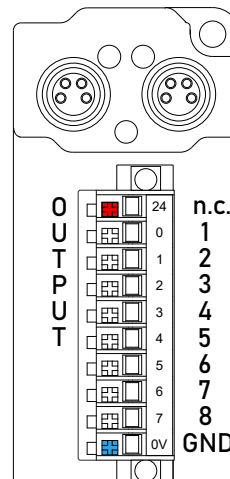

... with ZS2001-0002

The ZS2001 connectors are not included in the scope of delivery. See chapter [Accessories](#) [▶ 210].

**Pin assignment**

**NOTICE**

**Danger of confusion**

The pins are numbered differently on the box than on the ZS2001.

Pin	Imprint on the ZS2001	Description
n.c.	24	-
1	0	Output 1
2	1	Output 2
3	2	Output 3
4	3	Output 4
5	4	Output 5
6	5	Output 6
7	6	Output 7
8	7	Output 8
GND	0 V	GND

**Connection example**

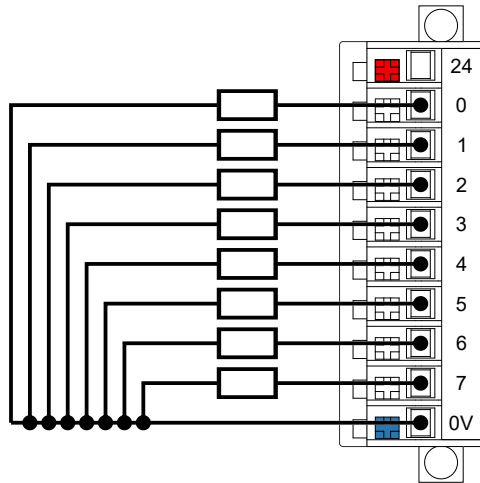

**5.2.5.9 M16 sockets**

**Pin assignment**

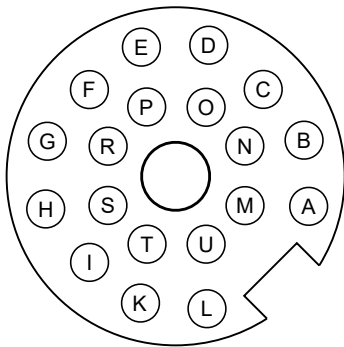

Pin	Description
A	Channel 1, Output 1
B	Channel 1, Output 2
C	Channel 1, Output 3
D	Channel 1, Output 4
E	Channel 1, Output 5
F	Channel 1, Output 6
G	Channel 1, Output 7
H	Channel 1, Output 8
I	Channel 2, Output 1
K	Channel 2, Output 2
L	Channel 2, Output 3
M	GND
N	Channel 2, Output 4
O	Channel 2, Output 5
P	Channel 2, Output 6
R	Channel 2, Output 7
S	Channel 2, Output 8
T	-
U	GND

### 5.2.5.10 D-sub sockets, 9-pin

#### Pin assignment

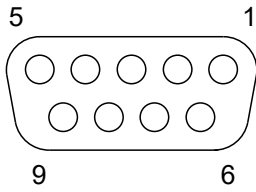

Pin	Function
1	Output 1
2	Output 2
3	Output 3
4	Output 4
5	Output 5
6	Output 6
7	Output 7
8	Output 8
9	GND

#### Connection example

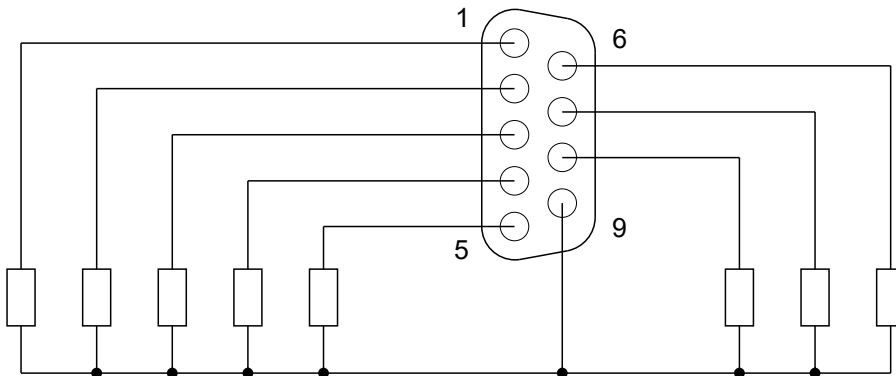

**5.2.5.11 D-Sub sockets, 25-pin (EP2816-0008 only)**

**Pin assignment**

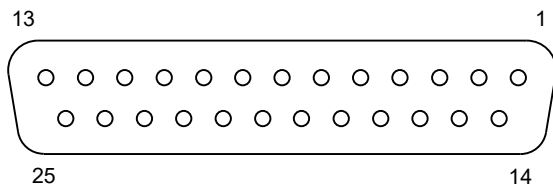

Pin	Function
1	Channel 1, Output 1
2	Channel 1, Output 2
3	Channel 1, Output 3
4	Channel 1, Output 4
5	Channel 1, Output 5
6	Channel 1, Output 6
7	Channel 1, Output 7
8	Channel 1, Output 8
9	Channel 2, Output 1
10	Channel 2, Output 2
11	Channel 2, Output 3
12	Channel 2, Output 4
13	Channel 2, Output 5
14	Channel 2, Output 6
15	Channel 2, Output 7
16	Channel 2, Output 8
17	+24 V <sub>DC</sub> U <sub>S</sub>
18	+24 V <sub>DC</sub> U <sub>S</sub>
19	+24 V <sub>DC</sub> U <sub>S</sub>
20	+24 V <sub>DC</sub> U <sub>S</sub>
21	+24 V <sub>DC</sub> U <sub>S</sub>
22	+24 V <sub>DC</sub> U <sub>S</sub>
23	GND
24	GND
25	GND

**Connection example**

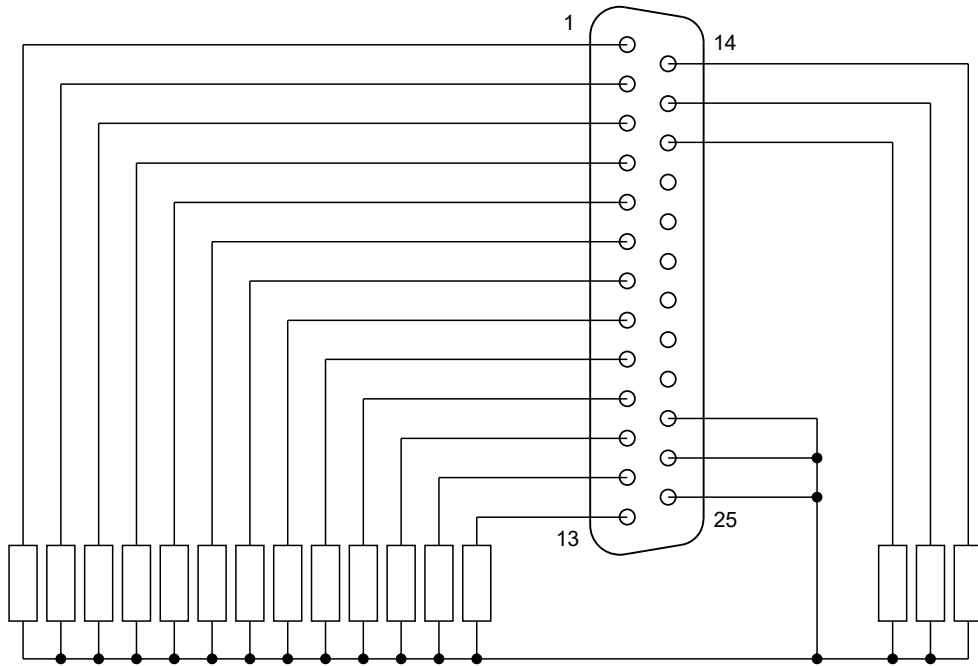



**5.2.5.12 D-Sub sockets, 25-pin (EP2817-0008 only)**

**Pin assignment**

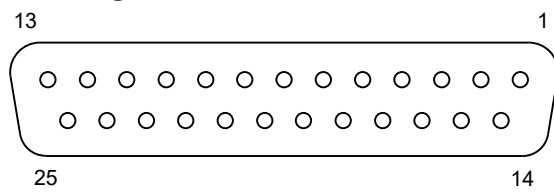

Pin	Function
1	Channel 1, Output 1
2	Channel 1, Output 3
3	Channel 1, Output 5
4	Channel 1, Output 7
5	Channel 2, Output 1
6	Channel 2, Output 3
7	Channel 2, Output 5
8	Channel 2, Output 7
9	Channel 3, Output 1
10	Channel 3, Output 3
11	Channel 3, Output 5
12	Channel 3, Output 7
13	GND <sub>p</sub>
14	Channel 1, Output 2
15	Channel 1, Output 4
16	Channel 1, Output 6
17	Channel 1, Output 8
18	Channel 2, Output 2
19	Channel 2, Output 4
20	Channel 2, Output 6
21	Channel 2, Output 8
22	Channel 3, Output 2
23	Channel 3, Output 4
24	Channel 3, Output 6
25	Channel 3, Output 8

**Connection example**

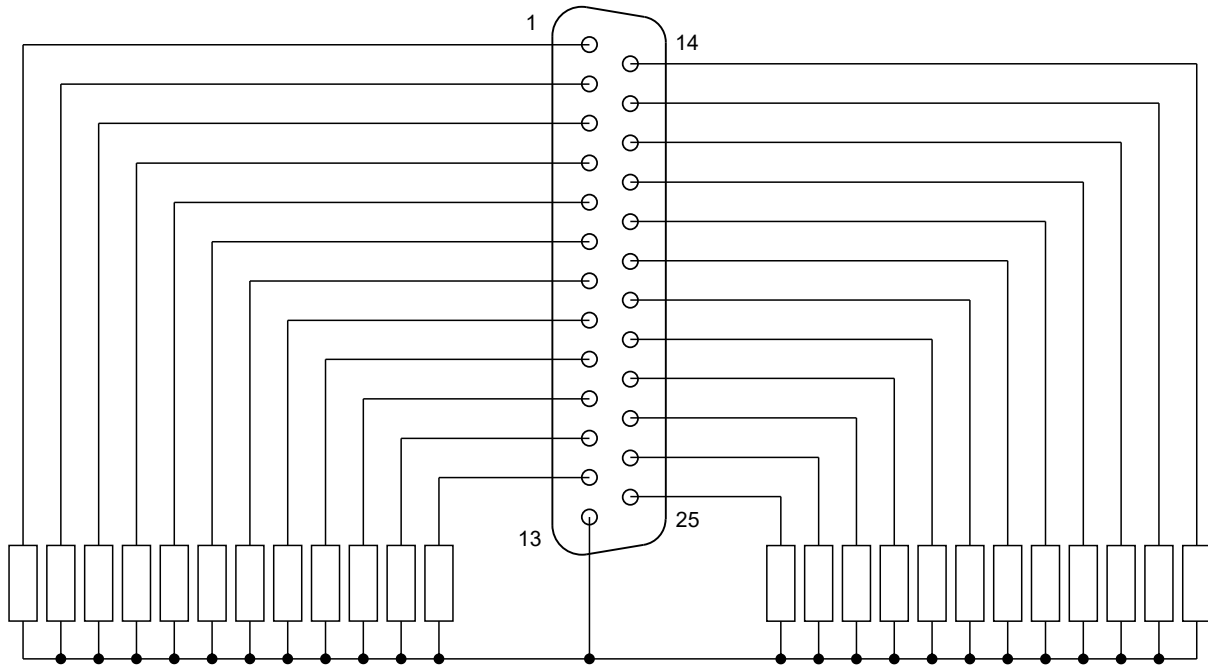

## 5.3 UL Requirements

The installation of the EtherCAT Box Modules certified by UL has to meet the following requirements.

### Supply voltage

#### ⚠ CAUTION

##### CAUTION!

This UL requirements are valid for all supply voltages of all marked EtherCAT Box Modules!  
For the compliance of the UL requirements the EtherCAT Box Modules should only be supplied

- by a 24 V<sub>DC</sub> supply voltage, supplied by an isolating source and protected by means of a fuse (in accordance with UL248), rated maximum 4 Amp, or
- by a 24 V<sub>DC</sub> power source, that has to satisfy *NEC class 2*.  
A *NEC class 2* power supply shall not be connected in series or parallel with another (class 2) power source!

#### ⚠ CAUTION

##### CAUTION!

To meet the UL requirements, the EtherCAT Box Modules must not be connected to unlimited power sources!

### Networks

#### ⚠ CAUTION

##### CAUTION!

To meet the UL requirements, EtherCAT Box Modules must not be connected to telecommunication networks!

### Ambient temperature range

#### ⚠ CAUTION

##### CAUTION!

To meet the UL requirements, EtherCAT Box Modules has to be operated only at an ambient temperature range of -25 °C to +55 °C!

### Marking for UL

All EtherCAT Box Modules certified by UL (Underwriters Laboratories) are marked with the following label.



Fig. 8: UL label

## 5.4 ATEX notes

### 5.4.1 ATEX - Special conditions

#### ⚠ WARNING

**Observe the special conditions for the intended use of EtherCAT Box modules in potentially explosive areas – directive 94/9/EU.**

- The certified components are to be installed with a BG2000-0000 or BG2000-0010 protection enclosure [▶ 117] that guarantees a protection against mechanical hazards!
- If the temperatures during rated operation are higher than 70°C at the feed-in points of cables, lines or pipes, or higher than 80°C at the wire branching points, then cables must be selected whose temperature data correspond to the actual measured temperature values!
- Observe the permissible ambient temperature range of 0 to 55°C for the use of EtherCAT Box modules in potentially explosive areas!
- Measures must be taken to protect against the rated operating voltage being exceeded by more than 40% due to short-term interference voltages!
- The connections of the certified components may only be connected or disconnected if the supply voltage has been switched off or if a non-explosive atmosphere is ensured!

#### Standards

The fundamental health and safety requirements are fulfilled by compliance with the following standards:

- EN 60079-0: 2006
- EN 60079-15: 2005

#### Marking

The EtherCAT Box modules certified for potentially explosive areas bear the following marking:



II 3 G Ex nA II T4 DEKRA 11ATEX0080 X Ta: 0 - 55°C

or



II 3 G Ex nA nC IIC T4 DEKRA 11ATEX0080 X Ta: 0 - 55°C

#### Batch number (D number)

The EtherCAT Box modules bear a batch number (D number) that is structured as follows:

D: WW YY FF HH

WW - week of production (calendar week)

YY - year of production

FF - firmware version

HH - hardware version

Example with batch number 29 10 02 01:

29 - week of production 29

10 - year of production 2010

02 - firmware version 02

01 - hardware version 01

## 5.4.2 BG2000 - EtherCAT Box protection enclosures

### ⚠ WARNING

#### Risk of electric shock and damage of device!

Bring the EtherCAT system into a safe, powered down state before starting installation, disassembly or wiring of the modules!

### ATEX

### ⚠ WARNING

#### Mount a protection enclosure!

To fulfill the special conditions according to ATEX [▶ 116], a BG2000-0000 or BG2000-0010 protection enclosure has to be mounted over the EtherCAT Box.

### Installation

Put the cables for EtherCAT, power supply and sensors/actuators through the hole of the protection enclosure.

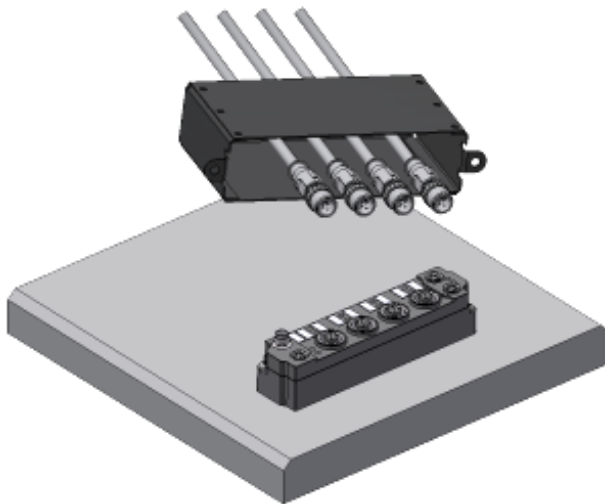

Fig. 9: BG2000 - putting the cables

Fix the wires for EtherCAT, power supply and sensors/actuators to the EtherCAT Box.

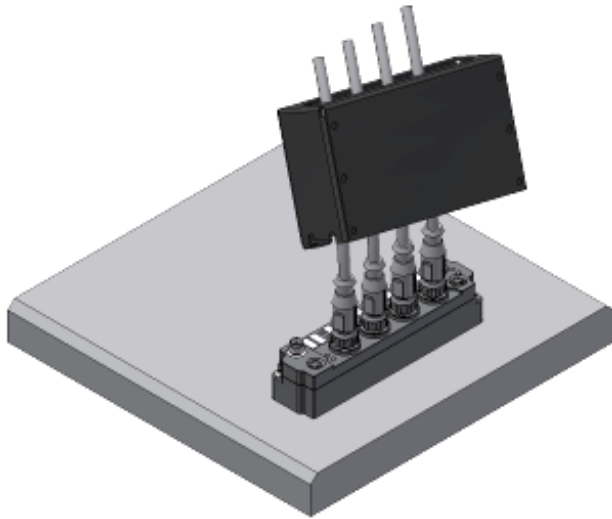

Fig. 10: BG2000 - fixing the cables

Mount the protection enclosure over the EtherCAT Box.

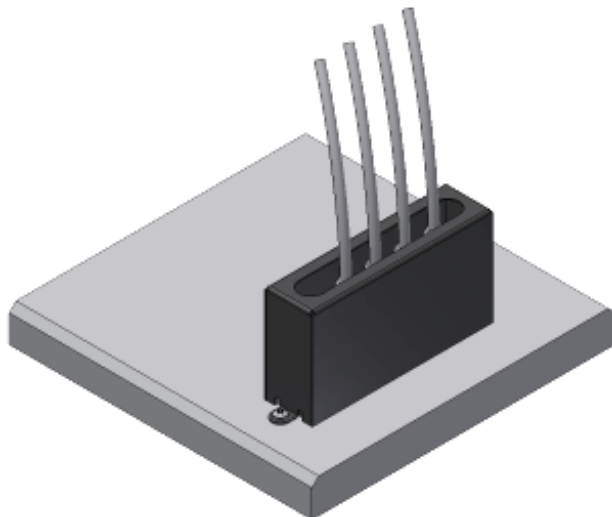

Fig. 11: BG2000 - mounting the protection enclosure

### 5.4.3 ATEX Documentation



#### **Notes about operation of EtherCAT Box Modules (EPxxxx-xxxx) in potentially explosive areas (ATEX)**

Pay also attention to the continuative documentation Notes about operation of EtherCAT Box Modules (EPxxxx-xxxx) in potentially explosive areas (ATEX) that is available in the download area of the Beckhoff homepage <http://www.beckhoff.com>!

## 5.5 Disposal



Products marked with a crossed-out wheeled bin shall not be discarded with the normal waste stream. The device is considered as waste electrical and electronic equipment. The national regulations for the disposal of waste electrical and electronic equipment must be observed.

## **6 Commissioning and configuration**

### **6.1 Integrating into a TwinCAT project**

The procedure for integration in a TwinCAT project is described in this [Quick start guide](#).



## 6.2 Behavior of the outputs in case of a fault

### 6.2.1 Behavior on EtherCAT failure

With the following products you can define which switching state the outputs are to assume in the event of an EtherCAT failure:

- EP2038-0042
- EP2816-0003
- EP2816-0004
- EP2816-0008
- EP2816-0010
- EP2817-0008
- EP2839-0022
- EP2839-0042

#### Functioning

If the EtherCAT state is not OP, the box switches all digital outputs to the switching state "Safe state value". This does not only happen in case of an EtherCAT failure, but also in the following cases, for example:

- EtherCAT start-up phase, e.g. shortly after switching on the supply voltage
- Manual change of the EtherCAT status by the EtherCAT master

#### Configure

In the factory setting the "Safe state value" of all outputs is the value FALSE. The outputs are therefore switched off if the EtherCAT communication fails.

You can set the value for each output individually.

- **EP2038-0042 and EP2839-00x2**

You can set the "Safe state value" in the CoE parameters  $80n00:05_{hex}$ . Example for channel 1:

Index	Name	Flags	Value	Unit
7050:0	DO Output Ch.6	RO	> 1 <	
7060:0	DO Output Ch.7	RO	> 1 <	
7070:0	DO Output Ch.8	RO	> 1 <	
8000:0	DO Settings Ch.1	RW	> 17 <	
8000:01	Detect open wire in off state	RW	FALSE	
8000:02	Detect open wire in on state	RW	FALSE	
8000:03	Detect short to 24V	RW	FALSE	
8000:04	Safe state active	RW	TRUE	
8000:05	Safe state value	RW	FALSE	
8000:11	Safe state delay	RW	0x0000 (0)	
8010:0	DO Settings Ch.2	RW	> 17 <	
8020:0	DO Settings Ch.3	RW	> 17 <	
8030:0	DO Settings Ch.4	RW	> 17 <	
8040:0	DO Settings Ch.5	RW	> 17 <	

Set Value Dialog

Dec: 0

Hex: 0x00

Float:

Bool: 0 1

Binary: 00

Bit Size: 1 8 16 32 64 ?

- **EP281x**

You can set the "Safe state value" in the CoE parameters 8001:0n and 8011:0n. Example for Output 1:

Index	Name	Flags	Value	Unit
7010:0	DIG Outputs Ch.2	RO	> 8 <	
8000:0	DIG Safe state active Ch.1	RW	> 8 <	
8001:0	DIG Safe state value Ch.1	RW	> 8 <	
8001:01	Output 1	RW	FALSE	
8001:02	Output 2	RW	FALSE	
8001:03	Output 3	RW	FALSE	
8001:04	Output 4	RW	FALSE	
8001:05	Output 5	RW	FALSE	
8001:06	Output 6	RW	FALSE	
8001:07	Output 7	RW	FALSE	
8001:08	Output 8	RW	FALSE	
8010:0	DIG Safe state active Ch.2	RW	> 8 <	
8011:0	DIG Safe state value Ch.2	RW	> 8 <	
F000:0	Modular device profile	RO	> 2 <	

**Set Value Dialog**

Dec:

Hex:

Float:

Boot:

Binary:

Bit Size:  1  8  16  32  64  ?

**Deactivate**

If you deactivate the function "Safe state", the respective channel retains after an EtherCAT failure the switching state it had before the communication failure.

In the factory setting, the function "Safe state" is activated for all outputs. You can deactivate them individually for each output.

- **EP2038-0042 and EP2839-00x2**

You can enable or disable the function in the CoE parameters 80n00:04<sub>hex</sub> "Safe state active". Example for channel 1:

Index	Name	Flags	Value	Unit
7050:0	DO Output Ch.6	RO	> 1 <	
7060:0	DO Output Ch.7	RO	> 1 <	
7070:0	DO Output Ch.8	RO	> 1 <	
8000:0	DO Settings Ch.1	RW	> 17 <	
8000:01	Detect open wire in off state	RW	FALSE	
8000:02	Detect open wire in on state	RW	FALSE	
8000:03	Detect short to 24V	RW	FALSE	
8000:04	Safe state active	RW	TRUE	
8000:05	Safe state value	RW	FALSE	
8000:11	Safe state delay	RW	0x0000 (0)	
8010:0	DO Settings Ch.2	RW	> 17 <	
8020:0	DO Settings Ch.3	RW	> 17 <	
8030:0	DO Settings Ch.4	RW	> 17 <	
8040:0	DO Settings Ch.5	RW	> 17 <	

Set Value Dialog

Dec: 0

Hex: 0x00

Float:

Bool: 0 1

Binary: 00

Bit Size: 1 8 16 32 64 ?

- **EP281x**

You can enable or disable the function in the CoE parameters 8000:0n and 8010:0n. Example for Output 1:

Index	Name	Flags	Value	Unit
7000:0	DIG Outputs Ch.1	RO	> 8 <	
7010:0	DIG Outputs Ch.2	RO	> 8 <	
8000:0	DIG Safe state active Ch.1	RW	> 8 <	
8000:01	Output 1	RW	TRUE	
8000:02	Output 2	RW	TRUE	
8000:03	Output 3	RW	TRUE	
8000:04	Output 4	RW	TRUE	
8000:05	Output 5	RW	TRUE	
8000:06	Output 6	RW	TRUE	
8000:07	Output 7	RW	TRUE	
8000:08	Output 8	RW	TRUE	
8001:0	DIG Safe state value Ch.1	RW	> 8 <	
8010:0	DIG Safe state active Ch.2	RW	> 8 <	
8011:0	DIG Safe state value Ch.2	RW	> 8 <	

Set Value Dialog

Dec: 0

Hex: 0x00

Float:

Bool: 0 1

Binary: 00

Bit Size: 1 8 16 32 64 ?

## 6.2.2 Behavior in case of short circuit (EP281x only)

You can set the behavior of the outputs in case of short circuit in the CoE object F800 "DO Settings".

### F800:0 - DO Settings (Safe State Value)

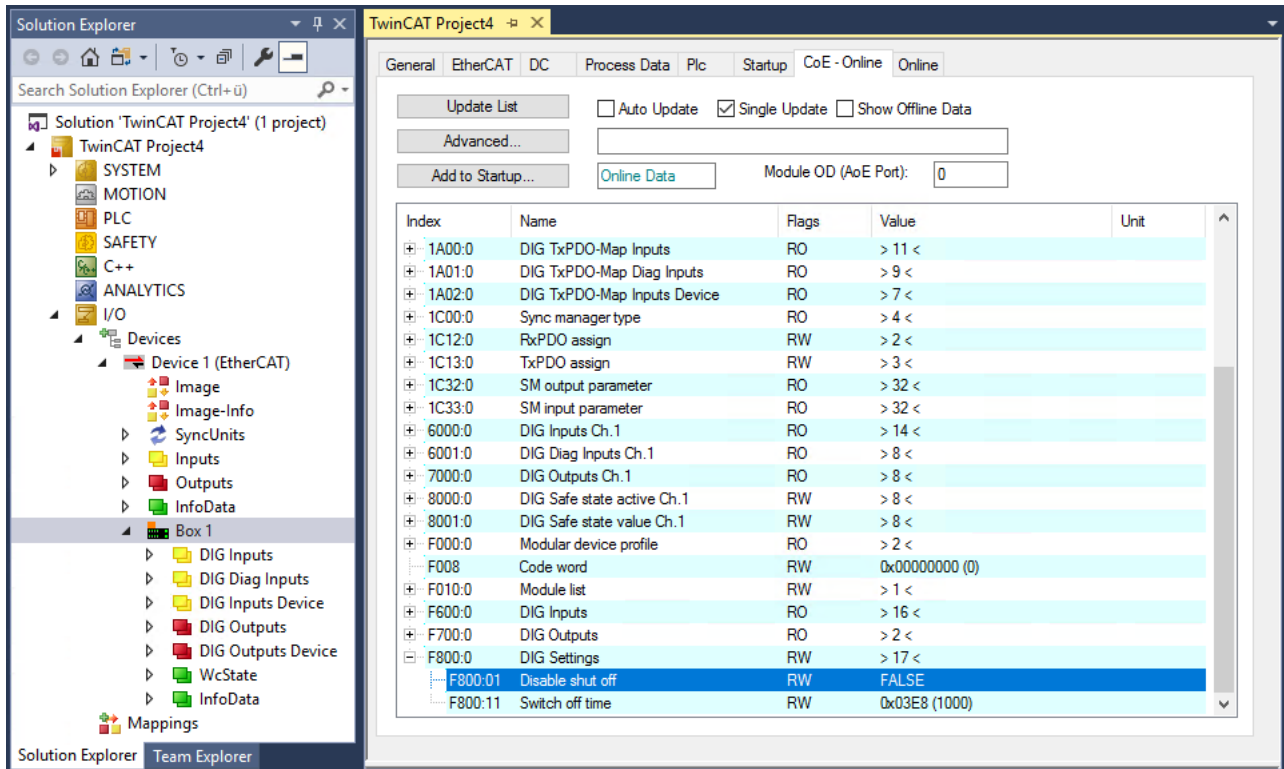

Table 1: F800:01 - Disable shut off (default: FALSE)

Value	Meaning
FALSE	In the event of a short circuit at one output, all outputs of the module are switched off. This disabling can be removed through the process data value <i>Reset Outputs</i> .
TRUE	In the event of a short circuit at an output, only this output of the module is switched off. After rectifying the short circuit, this output is automatically enabled again.

### F800:11 - Switch off time (default: 0x03E8, 1000<sub>dec</sub>)

Here you can enter a time in milliseconds. During this time, the module checks whether the short circuit has been eliminated by switching itself on again.

Default = 1000 ms (depending on module type and internal cycle time). Errors are only displayed after this time.

### 6.2.3 Behavior in case of missing supply voltage (EP281x only)

The digital outputs are supplied from the supply voltage  $U_p$ . If the supply voltage  $U_p$  is not present, the digital outputs cannot output a high level.

If an output is set and does not output a high level, this is detected as a fault. On expiry of the fault reaction time, the fault is reported in the process data:

- The "Diag Input x" bit of the output is set to "1".
- The "Error Channel y" bit of the channel to which the output belongs is set to "1".

In the factory setting, all outputs of a channel in which a fault has occurred are disabled. The outputs also remain disabled when  $U_p$  is switched on again.

#### Re-enabling outputs

There are two ways to re-enable disabled outputs:

- Manual: Apply a positive edge to the variable "Reset outputs".

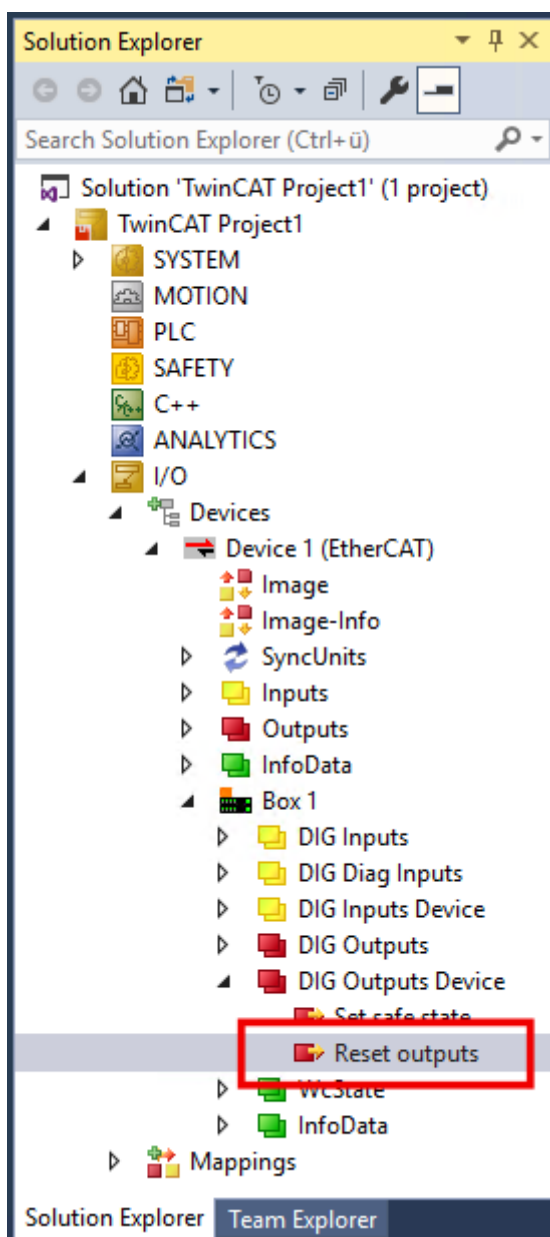

- Automatic: Set the parameter F800:01 to TRUE. All outputs will then be re-enabled as soon as  $U_p$  is switched on.  
Note: F800:01 also influences the behavior in case of short circuit.

### 6.3 Enable additional diagnostic functions

The following products allow advanced diagnostics of their digital outputs:

- EP2038-0042
- EP2839-0022
- EP2839-0042

The following diagnostic functions are disabled in the factory setting of these products:

- "Open load"
- "Short to 24 V"

You can enable these diagnostic functions for each digital output channel individually. Example for channel 1:

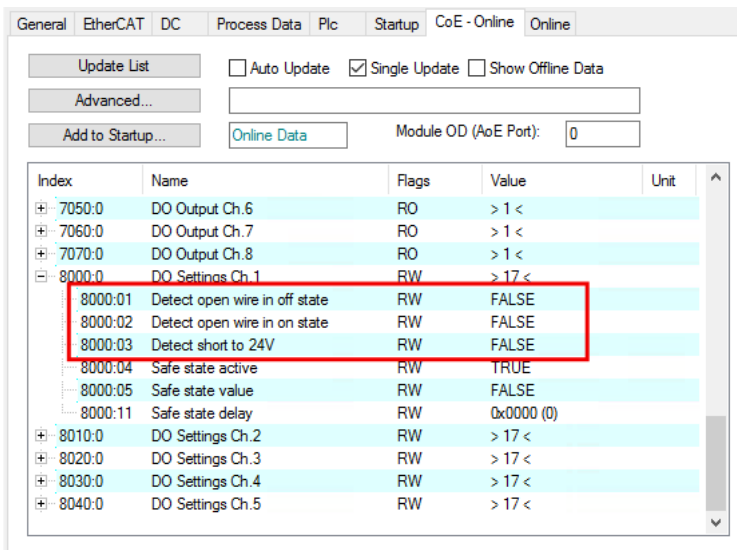

Function	CoE parameters to enable	
Wire break detection with output switched off	80n00:01	Detect open wire in off state
Wire break detection with output switched on	80n00:02	Detect open wire in on state
Detection of short circuits after 24 V	80n00:03	Detect short to 24V

## 6.4 Restore the delivery state

You can restore the delivery state of the backup objects as follows:

1. Ensure that TwinCAT is running in Config mode.
2. In CoE object 1011:0 "Restore default parameters" select parameter 1011:01 "Subindex 001".

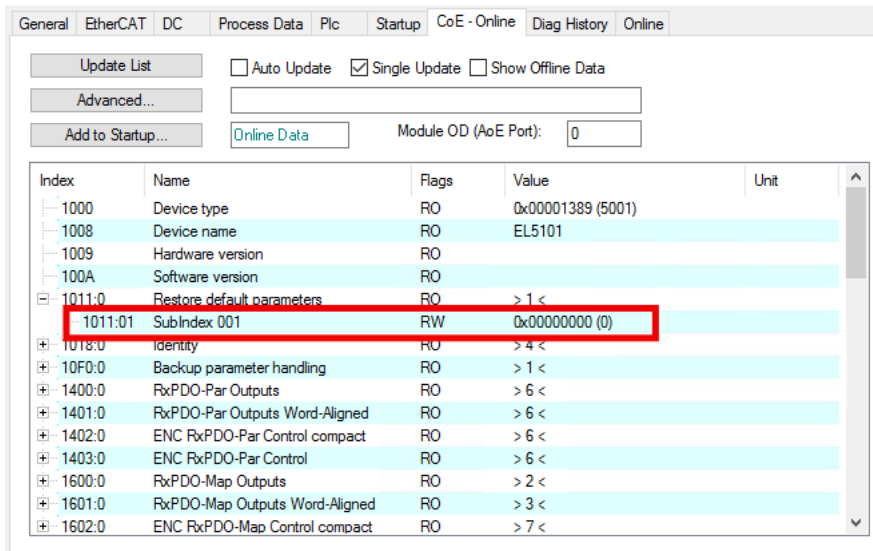

3. Double-click on "Subindex 001".  
⇒ The "Set Value Dialog" dialog box opens.
4. Enter the value 1684107116 in the "Dec" field.  
Alternatively: enter the value 0x64616F6C in the "Hex" field.

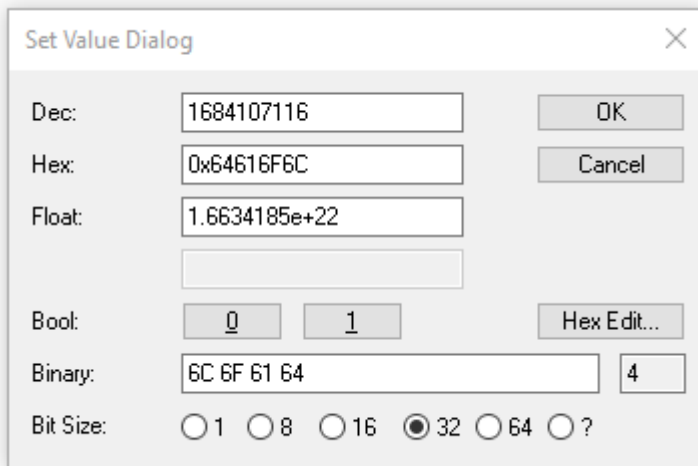

5. Confirm with "OK".  
⇒ All backup objects are reset to the delivery state.

### **i** Alternative restore value

With some older modules the backup objects can be changed with an alternative restore value:

Decimal value: 1819238756

Hexadecimal value: 0x6C6F6164

An incorrect entry for the restore value has no effect.

## 6.5 Decommissioning

**⚠ WARNING****Risk of electric shock!**

Bring the bus system into a safe, de-energized state before starting disassembly of the devices!



## 7 CoE parameters

### 7.1 EP2038-0042

#### 7.1.1 Object overview

Index (hex)	Name	Flags	Default value
1000 <a href="#">▶ 1351</a>	Device type	RO	0x00C81389 (13112201 <sub>dec</sub> )
1008 <a href="#">▶ 1351</a>	Device name	RO	EP2038-0042
1009 <a href="#">▶ 1351</a>	Hardware version	RO	
100A <a href="#">▶ 1351</a>	Software version	RO	00
100B <a href="#">▶ 1351</a>	Bootloader version	RO	N/A
1011:0 <a href="#">▶ 1351</a>	SubIndex	RO	0x01 (1 <sub>dec</sub> )
	1011:01	RW	0x00000000 (0 <sub>dec</sub> )
1018:0 <a href="#">▶ 1351</a>	SubIndex	RO	0x04 (4 <sub>dec</sub> )
	1018:01	RO	0x00000002 (2 <sub>dec</sub> )
	1018:02	RO	0x07F64052 (133578834 <sub>dec</sub> )
	1018:03	RO	0x00000000 (0 <sub>dec</sub> )
	1018:04	RO	0x00000000 (0 <sub>dec</sub> )
10E2:0 <a href="#">▶ 1351</a>	SubIndex	RO	0x01 (1 <sub>dec</sub> )
	10E2:01	RO	
10F0:0 <a href="#">▶ 1361</a>	SubIndex	RO	0x01 (1 <sub>dec</sub> )
	10F0:01	RO	0x00000000 (0 <sub>dec</sub> )
10F3:0 <a href="#">▶ 1361</a>	SubIndex	RO	0x15 (21 <sub>dec</sub> )
	10F3:01	RO	0x00 (0 <sub>dec</sub> )
	10F3:02	RO	0x00 (0 <sub>dec</sub> )
	10F3:03	RW	0x00 (0 <sub>dec</sub> )
	10F3:04	RO	0x00 (0 <sub>dec</sub> )
	10F3:05	RW	0x0000 (0 <sub>dec</sub> )
	10F3:06	RO	{0}
	10F3:07	RO	{0}
	10F3:08	RO	{0}
	10F3:09	RO	{0}
	10F3:0A	RO	{0}
	10F3:0B	RO	{0}
	10F3:0C	RO	{0}
	10F3:0D	RO	{0}
	10F3:0E	RO	{0}
	10F3:0F	RO	{0}
	10F3:10	RO	{0}
	10F3:11	RO	{0}
	10F3:12	RO	{0}
	10F3:13	RO	{0}
	10F3:14	RO	{0}
	10F3:15	RO	{0}
10F8 <a href="#">▶ 1361</a>	Timestamp Object	RO	
10F9:0 <a href="#">▶ 1361</a>	SubIndex	RO	0x01 (1 <sub>dec</sub> )
	10F9:01	RW	

Index (hex)	Name	Flags	Default value
1600:0 [▶ 136]	SubIndex	DO RxPDO-Map Output	RO 0x08 (8 <sub>dec</sub> )
	1600:01	SubIndex 001	RO 0x7000:01, 1
	1600:02	SubIndex 002	RO 0x7010:01, 1
	1600:03	SubIndex 003	RO 0x7020:01, 1
	1600:04	SubIndex 004	RO 0x7030:01, 1
	1600:05	SubIndex 005	RO 0x7040:01, 1
	1600:06	SubIndex 006	RO 0x7050:01, 1
	1600:07	SubIndex 007	RO 0x7060:01, 1
	1600:08	SubIndex 008	RO 0x7070:01, 1
1A00:0 [▶ 137]	SubIndex	DO TxPDO-Map Diagnosis	RO 0x20 (32 <sub>dec</sub> )
	1A00:01	SubIndex 001	RO 0x6002:01, 1
	1A00:02	SubIndex 002	RO 0x6002:02, 1
	1A00:03	SubIndex 003	RO 0x6002:03, 1
	1A00:04	SubIndex 004	RO 0x6002:04, 1
	1A00:05	SubIndex 005	RO 0x6012:01, 1
	1A00:06	SubIndex 006	RO 0x6012:02, 1
	1A00:07	SubIndex 007	RO 0x6012:03, 1
	1A00:08	SubIndex 008	RO 0x6012:04, 1
	1A00:09	SubIndex 009	RO 0x6022:01, 1
	1A00:0A	SubIndex 010	RO 0x6022:02, 1
	1A00:0B	SubIndex 011	RO 0x6022:03, 1
	1A00:0C	SubIndex 012	RO 0x6022:04, 1
	1A00:0D	SubIndex 013	RO 0x6032:01, 1
	1A00:0E	SubIndex 014	RO 0x6032:02, 1
	1A00:0F	SubIndex 015	RO 0x6032:03, 1
	1A00:10	SubIndex 016	RO 0x6032:04, 1
	1A00:11	SubIndex 017	RO 0x6042:01, 1
	1A00:12	SubIndex 018	RO 0x6042:02, 1
	1A00:13	SubIndex 019	RO 0x6042:03, 1
	1A00:14	SubIndex 020	RO 0x6042:04, 1
	1A00:15	SubIndex 021	RO 0x6052:01, 1
	1A00:16	SubIndex 022	RO 0x6052:02, 1
	1A00:17	SubIndex 023	RO 0x6052:03, 1
	1A00:18	SubIndex 024	RO 0x6052:04, 1
	1A00:19	SubIndex 025	RO 0x6062:01, 1
	1A00:1A	SubIndex 026	RO 0x6062:02, 1
	1A00:1B	SubIndex 027	RO 0x6062:03, 1
	1A00:1C	SubIndex 028	RO 0x6062:04, 1
	1A00:1D	SubIndex 029	RO 0x6072:01, 1
	1A00:1E	SubIndex 030	RO 0x6072:02, 1
	1A00:1F	SubIndex 031	RO 0x6072:03, 1
1A00:20	SubIndex 032	RO 0x6072:04, 1	
1A01:0 [▶ 137]	SubIndex	DEV TxPDO-Map Inputs Device	RO 0x07 (7 <sub>dec</sub> )
	1A01:01	SubIndex 001	RO 0xF600:01, 1
	1A01:02	SubIndex 002	RO 0xF600:02, 1
	1A01:03	SubIndex 003	RO 0xF600:03, 1
	1A01:04	SubIndex 004	RO 0x0000:00, 9
	1A01:05	SubIndex 005	RO 0xF600:0D, 1
	1A01:06	SubIndex 006	RO 0xF600:0E, 1
	1A01:07	SubIndex 007	RO 0xF600:0F, 2
1C00:0 [▶ 138]	SubIndex	Sync manager type	RO 0x04 (4 <sub>dec</sub> )
	1C00:01	SubIndex 001	RO 0x01 (1 <sub>dec</sub> )
	1C00:02	SubIndex 002	RO 0x02 (2 <sub>dec</sub> )
	1C00:03	SubIndex 003	RO 0x03 (3 <sub>dec</sub> )
	1C00:04	SubIndex 004	RO 0x04 (4 <sub>dec</sub> )

Index (hex)	Name	Flags	Default value	
1C12:0 ▶ 138]	SubIndex	RxPDO assign	RW	0x01 (1 <sub>dec</sub> )
	1C12:01	SubIndex 001	RW	0x1600 (5632 <sub>dec</sub> )
	1C12:02	SubIndex 002	RW	0x0000 (0 <sub>dec</sub> )
	1C12:03	SubIndex 003	RW	0x0000 (0 <sub>dec</sub> )
	1C12:04	SubIndex 004	RW	0x0000 (0 <sub>dec</sub> )
	1C12:05	SubIndex 005	RW	0x0000 (0 <sub>dec</sub> )
	1C12:06	SubIndex 006	RW	0x0000 (0 <sub>dec</sub> )
	1C12:07	SubIndex 007	RW	0x0000 (0 <sub>dec</sub> )
	1C12:08	SubIndex 008	RW	0x0000 (0 <sub>dec</sub> )
1C13:0 ▶ 138]	SubIndex	TxPDO assign	RW	0x01 (1 <sub>dec</sub> )
	1C13:01	SubIndex 001	RW	0x1A01 (6657 <sub>dec</sub> )
	1C13:02	SubIndex 002	RW	0x0000 (0 <sub>dec</sub> )
	1C13:03	SubIndex 003	RW	0x0000 (0 <sub>dec</sub> )
	1C13:04	SubIndex 004	RW	0x0000 (0 <sub>dec</sub> )
	1C13:05	SubIndex 005	RW	0x0000 (0 <sub>dec</sub> )
	1C13:06	SubIndex 006	RW	0x0000 (0 <sub>dec</sub> )
	1C13:07	SubIndex 007	RW	0x0000 (0 <sub>dec</sub> )
	1C13:08	SubIndex 008	RW	0x0000 (0 <sub>dec</sub> )
	1C13:09	SubIndex 009	RW	0x0000 (0 <sub>dec</sub> )
1C32:0 ▶ 139]	SubIndex	SM output parameter	RO	0x20 (32 <sub>dec</sub> )
	1C32:01	Sync mode	RW	0x0001 (1 <sub>dec</sub> )
	1C32:02	Cycle time	RW	0x000F4240 (1000000 <sub>dec</sub> )
	1C32:03	Shift time	RO	0x00000000 (0 <sub>dec</sub> )
	1C32:04	Sync modes supported	RO	0x440B (17419 <sub>dec</sub> )
	1C32:05	Minimum cycle time	RO	0x000186A0 (100000 <sub>dec</sub> )
	1C32:06	Calc and copy time	RO	0x00000000 (0 <sub>dec</sub> )
	1C32:07	Minimum delay time	RO	0x00000000 (0 <sub>dec</sub> )
	1C32:08	Get Cycle Time	RW	0x0000 (0 <sub>dec</sub> )
	1C32:09	Maximum delay time	RO	0x00000000 (0 <sub>dec</sub> )
	1C32:0B	SM event missed counter	RO	0x0000 (0 <sub>dec</sub> )
	1C32:0C	Cycle exceeded counter	RO	0x0000 (0 <sub>dec</sub> )
	1C32:0D	Shift too short counter	RO	0x0000 (0 <sub>dec</sub> )
	1C32:20	Sync error	RO	0x00 (0 <sub>dec</sub> )
1C33:0 ▶ 140]	SubIndex	SM input parameter	RO	0x20 (32 <sub>dec</sub> )
	1C33:01	Sync mode	RW	0x0022 (34 <sub>dec</sub> )
	1C33:02	Cycle time	RW	0x000F4240 (1000000 <sub>dec</sub> )
	1C33:03	Shift time	RO	0x000186A0 (100000 <sub>dec</sub> )
	1C33:04	Sync modes supported	RO	0x440B (17419 <sub>dec</sub> )
	1C33:05	Minimum cycle time	RO	0x000186A0 (100000 <sub>dec</sub> )
	1C33:06	Calc and copy time	RO	0x00000000 (0 <sub>dec</sub> )
	1C33:07	Minimum delay time	RO	0x00000000 (0 <sub>dec</sub> )
	1C33:08	Get Cycle Time	RW	0x0000 (0 <sub>dec</sub> )
	1C33:09	Maximum delay time	RO	0x00000000 (0 <sub>dec</sub> )
	1C33:0B	SM event missed counter	RO	0x0000 (0 <sub>dec</sub> )
	1C33:0C	Cycle exceeded counter	RO	0x0000 (0 <sub>dec</sub> )
	1C33:0D	Shift too short counter	RO	0x0000 (0 <sub>dec</sub> )
	1C33:20	Sync error	RO	0x00 (0 <sub>dec</sub> )
6002:0 ▶ 140]	SubIndex	DO Diagnosis Ch.1	RO	0x04 (4 <sub>dec</sub> )
	6002:01	Overcurrent	RO	0x00 (0 <sub>dec</sub> )
	6002:02	Overload	RO	0x00 (0 <sub>dec</sub> )
	6002:03	Open load	RO	0x00 (0 <sub>dec</sub> )
	6002:04	Short to 24V	RO	0x00 (0 <sub>dec</sub> )
6012:0 ▶ 141]	SubIndex	DO Diagnosis Ch.2	RO	0x04 (4 <sub>dec</sub> )
	6012:01	Overcurrent	RO	0x00 (0 <sub>dec</sub> )
	6012:02	Overload	RO	0x00 (0 <sub>dec</sub> )
	6012:03	Open load	RO	0x00 (0 <sub>dec</sub> )
	6012:04	Short to 24V	RO	0x00 (0 <sub>dec</sub> )

Index (hex)		Name	Flags	Default value
6022:0 ▶ 141]	SubIndex	DO Diagnosis Ch.3	RO	0x04 (4 <sub>dec</sub> )
	6022:01	Overcurrent	RO	0x00 (0 <sub>dec</sub> )
	6022:02	Overload	RO	0x00 (0 <sub>dec</sub> )
	6022:03	Open load	RO	0x00 (0 <sub>dec</sub> )
	6022:04	Short to 24V	RO	0x00 (0 <sub>dec</sub> )
6032:0 ▶ 141]	SubIndex	DO Diagnosis Ch.4	RO	0x04 (4 <sub>dec</sub> )
	6032:01	Overcurrent	RO	0x00 (0 <sub>dec</sub> )
	6032:02	Overload	RO	0x00 (0 <sub>dec</sub> )
	6032:03	Open load	RO	0x00 (0 <sub>dec</sub> )
	6032:04	Short to 24V	RO	0x00 (0 <sub>dec</sub> )
6042:0 ▶ 141]	SubIndex	DO Diagnosis Ch.5	RO	0x04 (4 <sub>dec</sub> )
	6042:01	Overcurrent	RO	0x00 (0 <sub>dec</sub> )
	6042:02	Overload	RO	0x00 (0 <sub>dec</sub> )
	6042:03	Open load	RO	0x00 (0 <sub>dec</sub> )
	6042:04	Short to 24V	RO	0x00 (0 <sub>dec</sub> )
6052:0 ▶ 141]	SubIndex	DO Diagnosis Ch.6	RO	0x04 (4 <sub>dec</sub> )
	6052:01	Overcurrent	RO	0x00 (0 <sub>dec</sub> )
	6052:02	Overload	RO	0x00 (0 <sub>dec</sub> )
	6052:03	Open load	RO	0x00 (0 <sub>dec</sub> )
	6052:04	Short to 24V	RO	0x00 (0 <sub>dec</sub> )
6062:0 ▶ 141]	SubIndex	DO Diagnosis Ch.7	RO	0x04 (4 <sub>dec</sub> )
	6062:01	Overcurrent	RO	0x00 (0 <sub>dec</sub> )
	6062:02	Overload	RO	0x00 (0 <sub>dec</sub> )
	6062:03	Open load	RO	0x00 (0 <sub>dec</sub> )
	6062:04	Short to 24V	RO	0x00 (0 <sub>dec</sub> )
6072:0 ▶ 142]	SubIndex	DO Diagnosis Ch.8	RO	0x04 (4 <sub>dec</sub> )
	6072:01	Overcurrent	RO	0x00 (0 <sub>dec</sub> )
	6072:02	Overload	RO	0x00 (0 <sub>dec</sub> )
	6072:03	Open load	RO	0x00 (0 <sub>dec</sub> )
	6072:04	Short to 24V	RO	0x00 (0 <sub>dec</sub> )
7000:0 ▶ 142]	SubIndex	DO Output Ch.1	RO	0x01 (1 <sub>dec</sub> )
	7000:01	Output	RO	0x00 (0 <sub>dec</sub> )
7010:0 ▶ 142]	SubIndex	DO Output Ch.2	RO	0x01 (1 <sub>dec</sub> )
	7010:01	Output	RO	0x00 (0 <sub>dec</sub> )
7020:0 ▶ 142]	SubIndex	DO Output Ch.3	RO	0x01 (1 <sub>dec</sub> )
	7020:01	Output	RO	0x00 (0 <sub>dec</sub> )
7030:0 ▶ 142]	SubIndex	DO Output Ch.4	RO	0x01 (1 <sub>dec</sub> )
	7030:01	Output	RO	0x00 (0 <sub>dec</sub> )
7040:0 ▶ 142]	SubIndex	DO Output Ch.5	RO	0x01 (1 <sub>dec</sub> )
	7040:01	Output	RO	0x00 (0 <sub>dec</sub> )
7050:0 ▶ 142]	SubIndex	DO Output Ch.6	RO	0x01 (1 <sub>dec</sub> )
	7050:01	Output	RO	0x00 (0 <sub>dec</sub> )
7060:0 ▶ 142]	SubIndex	DO Output Ch.7	RO	0x01 (1 <sub>dec</sub> )
	7060:01	Output	RO	0x00 (0 <sub>dec</sub> )
7070:0 ▶ 142]	SubIndex	DO Output Ch.8	RO	0x01 (1 <sub>dec</sub> )
	7070:01	Output	RO	0x00 (0 <sub>dec</sub> )
8000:0 ▶ 143]	SubIndex	DO Settings Ch.1	RW	0x11 (17 <sub>dec</sub> )
	8000:01	Detect open wire in off state	RW	0x00 (0 <sub>dec</sub> )
	8000:02	Detect open wire in on state	RW	0x00 (0 <sub>dec</sub> )
	8000:03	Detect short to 24V	RW	0x00 (0 <sub>dec</sub> )
	8000:04	Safe state active	RW	0x01 (1 <sub>dec</sub> )
	8000:05	Safe state value	RW	0x00 (0 <sub>dec</sub> )
	8000:11	Safe state delay	RW	0x0000 (0 <sub>dec</sub> )

Index (hex)	Name	Flags	Default value
8010:0 [▶ 143]	SubIndex DO Settings Ch.2	RW	0x11 (17 <sub>dec</sub> )
	8010:01 Detect open wire in off state	RW	0x00 (0 <sub>dec</sub> )
	8010:02 Detect open wire in on state	RW	0x00 (0 <sub>dec</sub> )
	8010:03 Detect short to 24V	RW	0x00 (0 <sub>dec</sub> )
	8010:04 Safe state active	RW	0x01 (1 <sub>dec</sub> )
	8010:05 Safe state value	RW	0x00 (0 <sub>dec</sub> )
	8010:11 Safe state delay	RW	0x0000 (0 <sub>dec</sub> )
8020:0 [▶ 143]	SubIndex DO Settings Ch.3	RW	0x11 (17 <sub>dec</sub> )
	8020:01 Detect open wire in off state	RW	0x00 (0 <sub>dec</sub> )
	8020:02 Detect open wire in on state	RW	0x00 (0 <sub>dec</sub> )
	8020:03 Detect short to 24V	RW	0x00 (0 <sub>dec</sub> )
	8020:04 Safe state active	RW	0x01 (1 <sub>dec</sub> )
	8020:05 Safe state value	RW	0x00 (0 <sub>dec</sub> )
	8020:11 Safe state delay	RW	0x0000 (0 <sub>dec</sub> )
8030:0 [▶ 144]	SubIndex DO Settings Ch.4	RW	0x11 (17 <sub>dec</sub> )
	8030:01 Detect open wire in off state	RW	0x00 (0 <sub>dec</sub> )
	8030:02 Detect open wire in on state	RW	0x00 (0 <sub>dec</sub> )
	8030:03 Detect short to 24V	RW	0x00 (0 <sub>dec</sub> )
	8030:04 Safe state active	RW	0x01 (1 <sub>dec</sub> )
	8030:05 Safe state value	RW	0x00 (0 <sub>dec</sub> )
	8030:11 Safe state delay	RW	0x0000 (0 <sub>dec</sub> )
8040:0 [▶ 144]	SubIndex DO Settings Ch.5	RW	0x11 (17 <sub>dec</sub> )
	8040:01 Detect open wire in off state	RW	0x00 (0 <sub>dec</sub> )
	8040:02 Detect open wire in on state	RW	0x00 (0 <sub>dec</sub> )
	8040:03 Detect short to 24V	RW	0x00 (0 <sub>dec</sub> )
	8040:04 Safe state active	RW	0x01 (1 <sub>dec</sub> )
	8040:05 Safe state value	RW	0x00 (0 <sub>dec</sub> )
	8040:11 Safe state delay	RW	0x0000 (0 <sub>dec</sub> )
8050:0 [▶ 144]	SubIndex DO Settings Ch.6	RW	0x11 (17 <sub>dec</sub> )
	8050:01 Detect open wire in off state	RW	0x00 (0 <sub>dec</sub> )
	8050:02 Detect open wire in on state	RW	0x00 (0 <sub>dec</sub> )
	8050:03 Detect short to 24V	RW	0x00 (0 <sub>dec</sub> )
	8050:04 Safe state active	RW	0x01 (1 <sub>dec</sub> )
	8050:05 Safe state value	RW	0x00 (0 <sub>dec</sub> )
	8050:11 Safe state delay	RW	0x0000 (0 <sub>dec</sub> )
8060:0 [▶ 145]	SubIndex DO Settings Ch.7	RW	0x11 (17 <sub>dec</sub> )
	8060:01 Detect open wire in off state	RW	0x00 (0 <sub>dec</sub> )
	8060:02 Detect open wire in on state	RW	0x00 (0 <sub>dec</sub> )
	8060:03 Detect short to 24V	RW	0x00 (0 <sub>dec</sub> )
	8060:04 Safe state active	RW	0x01 (1 <sub>dec</sub> )
	8060:05 Safe state value	RW	0x00 (0 <sub>dec</sub> )
	8060:11 Safe state delay	RW	0x0000 (0 <sub>dec</sub> )
8070:0 [▶ 145]	SubIndex DO Settings Ch.8	RW	0x11 (17 <sub>dec</sub> )
	8070:01 Detect open wire in off state	RW	0x00 (0 <sub>dec</sub> )
	8070:02 Detect open wire in on state	RW	0x00 (0 <sub>dec</sub> )
	8070:03 Detect short to 24V	RW	0x00 (0 <sub>dec</sub> )
	8070:04 Safe state active	RW	0x01 (1 <sub>dec</sub> )
	8070:05 Safe state value	RW	0x00 (0 <sub>dec</sub> )
	8070:11 Safe state delay	RW	0x0000 (0 <sub>dec</sub> )
F000:0 [▶ 145]	SubIndex Modular Device Profile	RO	0x02 (2 <sub>dec</sub> )
	F000:01 Index distance	RO	0x0010 (16 <sub>dec</sub> )
	F000:02 Maximum number of modules	RO	0x0008 (8 <sub>dec</sub> )
F008 [▶ 145]	Code word	RW	0x00000000 (0 <sub>dec</sub> )

Index (hex)		Name	Flags	Default value
F600:0 [▶ 146]	SubIndex	DEV Inputs	RO	0x0F (15 <sub>dec</sub> )
	F600:01	Undervoltage Us	RO	0x00 (0 <sub>dec</sub> )
	F600:02	Undervoltage Up	RO	0x00 (0 <sub>dec</sub> )
	F600:03	Overtemperature	RO	0x00 (0 <sub>dec</sub> )
	F600:0D	Diag	RO	0x00 (0 <sub>dec</sub> )
	F600:0E	TxPDO State	RO	0x00 (0 <sub>dec</sub> )
	F600:0F	Input cycle counter	RO	0x00 (0 <sub>dec</sub> )
F800:0 [▶ 146]	SubIndex	DEV Settings	RW	0x12 (18 <sub>dec</sub> )
	F800:10	Us undervoltage detection threshold	RW	0x0000 (0 <sub>dec</sub> )
	F800:12	Up undervoltage detection threshold	RW	0x0000 (0 <sub>dec</sub> )
F900:0 [▶ 146]	SubIndex	DEV Info data	RO	0x05 (5 <sub>dec</sub> )
	F900:02	Internal Temperature	RO	0x00 (0 <sub>dec</sub> )
	F900:04	Voltage Us	RO	0x0000 (0 <sub>dec</sub> )
	F900:05	Voltage Up	RO	0x0000 (0 <sub>dec</sub> )
FB00:0 [▶ 146]	SubIndex	DEV Command	RO	0x03 (3 <sub>dec</sub> )
	FB00:01	Request	RW	{0}
	FB00:02	Status	RO	0x00 (0 <sub>dec</sub> )
	FB00:03	Response	RW	{0}

### Key

Flags:

RO (Read Only): this object can only be read

RW (Read/Write): this object can be read and written to

## 7.1.2 Object description and parameterization

### 7.1.2.1 Standard objects (0x1000-0x1FFF)

The standard objects have the same meaning for all EtherCAT slaves.

#### Index 1000 Device type

Index	Name	Meaning	Data type	Flags	Default
1000:0	Device type	Device type of the EtherCAT slave: the Lo-Word contains the used CoE profile (5001). The Hi-Word contains the module profile according to the modular device profile.	UINT32	RO	0x00C81389 (13112201 <sub>dec</sub> )

#### Index 1008 Device name

Index	Name	Meaning	Data type	Flags	Default
1008:0	Device name	Device name of the EtherCAT slave	STRING	RO	EP2038-0042

#### Index 1009 Hardware version

Index	Name	Meaning	Data type	Flags	Default
1009:0	Hardware version	Hardware version of the EtherCAT slave	STRING	RO	

#### Index 100A Software version

Index	Name	Meaning	Data type	Flags	Default
100A:0	Software version	Firmware version of the EtherCAT slave	STRING	RO	00

#### Index 100B Bootloader version

Index	Name	Meaning	Data type	Flags	Default
100B:0	Bootloader version	Bootloader version	STRING	RO	N/A

#### Index 1011 Restore default parameters

Index	Name	Meaning	Data type	Flags	Default
1011:0	Restore default parameters	Restore default settings	UINT8	RO	0x01 (1 <sub>dec</sub> )
1011:01	SubIndex 001	If this object is set to "0x64616F6C" in the set value dialog, all backup objects are reset to their delivery state.	UINT32	RW	0x00000000 (0 <sub>dec</sub> )

#### Index 1018 Identity

Index	Name	Meaning	Data type	Flags	Default
1018:0	Identity	Information for identifying the slave	UINT8	RO	0x04 (4 <sub>dec</sub> )
1018:01	Vendor ID	Vendor ID of the EtherCAT slave	UINT32	RO	0x00000002 (2 <sub>dec</sub> )
1018:02	Product code	Product code of the EtherCAT slave	UINT32	RO	0x07F64052 (133578834 <sub>dec</sub> )
1018:03	Revision	Revision number of the EtherCAT slave; the Low Word (bit 0-15) indicates the special terminal number, the High Word (bit 16-31) refers to the device description	UINT32	RO	0x00000000 (0 <sub>dec</sub> )
1018:04	Serial number	Serial number of the EtherCAT slave; the Low Byte (bit 0-7) of the Low Word contains the year of production, the High Byte (bit 8-15) of the Low Word contains the week of production, the High Word (bit 16-31) is 0	UINT32	RO	0x00000000 (0 <sub>dec</sub> )

#### Index 10E2 Manufacturer-specific Identification Code

Index	Name	Meaning	Data type	Flags	Default
10E2:0	Manufacturer-specific Identification Code		UINT8	RO	0x01 (1 <sub>dec</sub> )
10E2:01	SubIndex 001		STRING	RO	

**Index 10F0 Backup parameter handling**

Index	Name	Meaning	Data type	Flags	Default
10F0:0	Backup parameter handling	Information for standardized loading and saving of backup entries	UINT8	RO	0x01 (1 <sub>dec</sub> )
10F00:01	Checksum	Checksum across all backup entries of the EtherCAT slave	UINT32	RO	0x00000000 (0 <sub>dec</sub> )

**Index 10F3 Diagnosis History**

Index (hex)	Name	Meaning	Data type	Flags	Default
10F3:0	Diagnosis History	Maximum subindex	UINT8	RO	0x15 (21 <sub>dec</sub> )
10F3:01	Maximum Messages	Maximum number of stored messages A maximum of 16 messages can be stored	UINT8	RO	0x00 (0 <sub>dec</sub> )
10F3:02	Newest Message	Subindex of the latest message	UINT8	RO	0x00 (0 <sub>dec</sub> )
10F3:03	Newest Acknowledged Message	Subindex of the last confirmed message	UINT8	RW	0x00 (0 <sub>dec</sub> )
10F3:04	New Messages Available	Indicates that a new message is available	BOOLEAN	RO	0x00 (0 <sub>dec</sub> )
10F3:05	Flags		UINT16	RW	0x0000 (0 <sub>dec</sub> )
10F3:06	Diagnosis Message 001	Message 1	OCTET-STRING[20]	RO	{0}
...	...	..	...	...	...
10F3:15	Diagnosis Message 016	Message 16	OCTET-STRING[20]	RO	{0}

**Index 10F8 Timestamp Object**

Index	Name	Meaning	Data type	Flags	Default
10F8:0	Timestamp Object		UINT64	RO	

**Index 10F9 Time Distribution Object**

Index	Name	Meaning	Data type	Flags	Default
10F9:0	Time Distribution Object	Max Subindex	UINT8	RO	0x01 (1 <sub>dec</sub> )
10F9:01	Distributed Time Value	Object for time distribution by the EtherCAT master	UINT64	RW	

**Index 1600 DO RxPDO-Map Output**

Index	Name	Meaning	Data type	Flags	Default
1600:0	DO RxPDO-Map Output	PDO Mapping RxPDO 1	UINT8	RO	0x08 (8 <sub>dec</sub> )
1600:01	SubIndex 001	1. PDO Mapping entry (object 0x7000 (DO Output Ch.1), entry 0x01 (Output))	UINT32	RO	0x7000:01, 1
1600:02	SubIndex 002	2. PDO Mapping entry (object 0x7010 (DO Output Ch.2), entry 0x01 (Output))	UINT32	RO	0x7010:01, 1
1600:03	SubIndex 003	3. PDO Mapping entry (object 0x7020 (DO Output Ch.3), entry 0x01 (Output))	UINT32	RO	0x7020:01, 1
1600:04	SubIndex 004	4. PDO Mapping entry (object 0x7030 (DO Output Ch.4), entry 0x01 (Output))	UINT32	RO	0x7030:01, 1
1600:05	SubIndex 005	5. PDO Mapping entry (object 0x7040 (DO Output Ch.5), entry 0x01 (Output))	UINT32	RO	0x7040:01, 1
1600:06	SubIndex 006	6. PDO Mapping entry (object 0x7050 (DO Output Ch.6), entry 0x01 (Output))	UINT32	RO	0x7050:01, 1
1600:07	SubIndex 007	7. PDO Mapping entry (object 0x7060 (DO Output Ch.7), entry 0x01 (Output))	UINT32	RO	0x7060:01, 1
1600:08	SubIndex 008	8. PDO Mapping entry (object 0x7070 (DO Output Ch.8), entry 0x01 (Output))	UINT32	RO	0x7070:01, 1



**Index 1A00 DO TxPDO-Map Diagnosis**

Index	Name	Meaning	Data type	Flags	Default
1A00:0	DO TxPDO-Map Diagnosis	PDO Mapping TxPDO 1	UINT8	RO	0x20 (32 <sub>dec</sub> )
1A00:01	SubIndex 001	1. PDO Mapping entry (object 0x6004, entry 0x01)	UINT32	RO	0x6002:01, 1
1A00:02	SubIndex 002	2. PDO Mapping entry (object 0x6004, entry 0x02)	UINT32	RO	0x6002:02, 1
1A00:03	SubIndex 003	3. PDO Mapping entry (object 0x6004, entry 0x03)	UINT32	RO	0x6002:03, 1
1A00:04	SubIndex 004	4. PDO Mapping entry (object 0x6004, entry 0x04)	UINT32	RO	0x6002:04, 1
1A00:05	SubIndex 005	5. PDO Mapping entry (object 0x6014, entry 0x01)	UINT32	RO	0x6012:01, 1
1A00:06	SubIndex 006	6. PDO Mapping entry (object 0x6014, entry 0x02)	UINT32	RO	0x6012:02, 1
1A00:07	SubIndex 007	7. PDO Mapping entry (object 0x6014, entry 0x03)	UINT32	RO	0x6012:03, 1
1A00:08	SubIndex 008	8. PDO Mapping entry (object 0x6014, entry 0x04)	UINT32	RO	0x6012:04, 1
1A00:09	SubIndex 009	9. PDO Mapping entry (object 0x6024, entry 0x01)	UINT32	RO	0x6022:01, 1
1A00:0A	SubIndex 010	10. PDO Mapping entry (object 0x6024, entry 0x02)	UINT32	RO	0x6022:02, 1
1A00:0B	SubIndex 011	11. PDO Mapping entry (object 0x6024, entry 0x03)	UINT32	RO	0x6022:03, 1
1A00:0C	SubIndex 012	12. PDO Mapping entry (object 0x6024, entry 0x04)	UINT32	RO	0x6022:04, 1
1A00:0D	SubIndex 013	13. PDO Mapping entry (object 0x6034, entry 0x01)	UINT32	RO	0x6032:01, 1
1A00:0E	SubIndex 014	14. PDO Mapping entry (object 0x6034, entry 0x02)	UINT32	RO	0x6032:02, 1
1A00:0F	SubIndex 015	15. PDO Mapping entry (object 0x6034, entry 0x03)	UINT32	RO	0x6032:03, 1
1A00:10	SubIndex 016	16. PDO Mapping entry (object 0x6034, entry 0x04)	UINT32	RO	0x6032:04, 1
1A00:11	SubIndex 017	17. PDO Mapping entry (object 0x6044, entry 0x01)	UINT32	RO	0x6042:01, 1
1A00:12	SubIndex 018	18. PDO Mapping entry (object 0x6044, entry 0x02)	UINT32	RO	0x6042:02, 1
1A00:13	SubIndex 019	19. PDO Mapping entry (object 0x6044, entry 0x03)	UINT32	RO	0x6042:03, 1
1A00:14	SubIndex 020	20. PDO Mapping entry (object 0x6044, entry 0x04)	UINT32	RO	0x6042:04, 1
1A00:15	SubIndex 021	21. PDO Mapping entry (object 0x6054, entry 0x01)	UINT32	RO	0x6052:01, 1
1A00:16	SubIndex 022	22. PDO Mapping entry (object 0x6054, entry 0x02)	UINT32	RO	0x6052:02, 1
1A00:17	SubIndex 023	23. PDO Mapping entry (object 0x6054, entry 0x03)	UINT32	RO	0x6052:03, 1
1A00:18	SubIndex 024	24. PDO Mapping entry (object 0x6054, entry 0x04)	UINT32	RO	0x6052:04, 1
1A00:19	SubIndex 025	25. PDO Mapping entry (object 0x6064, entry 0x01)	UINT32	RO	0x6062:01, 1
1A00:1A	SubIndex 026	26. PDO Mapping entry (object 0x6064, entry 0x02)	UINT32	RO	0x6062:02, 1
1A00:1B	SubIndex 027	27. PDO Mapping entry (object 0x6064, entry 0x03)	UINT32	RO	0x6062:03, 1
1A00:1C	SubIndex 028	28. PDO Mapping entry (object 0x6064, entry 0x04)	UINT32	RO	0x6062:04, 1
1A00:1D	SubIndex 029	29. PDO Mapping entry (object 0x6074, entry 0x01)	UINT32	RO	0x6072:01, 1
1A00:1E	SubIndex 030	30. PDO Mapping entry (object 0x6074, entry 0x02)	UINT32	RO	0x6072:02, 1
1A00:1F	SubIndex 031	31. PDO Mapping entry (object 0x6074, entry 0x03)	UINT32	RO	0x6072:03, 1
1A00:20	SubIndex 032	32. PDO Mapping entry (object 0x6074, entry 0x04)	UINT32	RO	0x6072:04, 1

**Index 1A01 DEV TxPDO-Map Inputs Device**

Index	Name	Meaning	Data type	Flags	Default
1A01:0	DEV TxPDO-Map Inputs Device	PDO Mapping TxPDO 2	UINT8	RO	0x07 (7 <sub>dec</sub> )
1A01:01	SubIndex 001	1. PDO Mapping entry (object 0xF600 (DEV Inputs), entry 0x01 (Undervoltage Us))	UINT32	RO	0xF600:01, 1
1A01:02	SubIndex 002	2. PDO Mapping entry (object 0xF600 (DEV Inputs), entry 0x02 (Undervoltage Up))	UINT32	RO	0xF600:02, 1
1A01:03	SubIndex 003	3. PDO Mapping entry (object 0xF600 (DEV Inputs), entry 0x03 (Overtemperature))	UINT32	RO	0xF600:03, 1
1A01:04	SubIndex 004	4. PDO Mapping entry (9 bits align)	UINT32	RO	0x0000:00, 9
1A01:05	SubIndex 005	5. PDO Mapping entry (object 0xF600 (DEV Inputs), entry 0x0D (Diag))	UINT32	RO	0xF600:0D, 1
1A01:06	SubIndex 006	6. PDO Mapping entry (object 0xF600 (DEV Inputs), entry 0x0E (TxPDO State))	UINT32	RO	0xF600:0E, 1
1A01:07	SubIndex 007	7. PDO Mapping entry (object 0xF600 (DEV Inputs), entry 0x0F (Input cycle counter))	UINT32	RO	0xF600:0F, 2

## Index 1C00 Sync manager type

Index	Name	Meaning	Data type	Flags	Default
1C00:0	Sync manager type	Using the Sync Managers	UINT8	RO	0x04 (4 <sub>dec</sub> )
1C00:01	SubIndex 001	Sync-Manager Type Channel 1: Mailbox Write	UINT8	RO	0x01 (1 <sub>dec</sub> )
1C00:02	SubIndex 002	Sync-Manager Type Channel 2: Mailbox Read	UINT8	RO	0x02 (2 <sub>dec</sub> )
1C00:03	SubIndex 003	Sync-Manager Type Channel 3: Process Data Write (Outputs)	UINT8	RO	0x03 (3 <sub>dec</sub> )
1C00:04	SubIndex 004	Sync-Manager Type Channel 4: Process Data Read (Inputs)	UINT8	RO	0x04 (4 <sub>dec</sub> )

## Index 1C12 RxPDO assign

Index	Name	Meaning	Data type	Flags	Default
1C12:0	RxPDO assign	PDO Assign Outputs	UINT8	RW	0x01 (1 <sub>dec</sub> )
1C12:01	Subindex 001	1. allocated RxPDO (contains the index of the associated RxPDO mapping object)	UINT16	RW	0x1600 (5632 <sub>dec</sub> )
1C12:02	Subindex 002	2. allocated RxPDO (contains the index of the associated RxPDO mapping object)	UINT16	RW	0x0000 (0 <sub>dec</sub> )
1C12:03	Subindex 003	3. allocated RxPDO (contains the index of the associated RxPDO mapping object)	UINT16	RW	0x0000 (0 <sub>dec</sub> )
1C12:04	Subindex 004	4. allocated RxPDO (contains the index of the associated RxPDO mapping object)	UINT16	RW	0x0000 (0 <sub>dec</sub> )
1C12:05	Subindex 005	5. allocated RxPDO (contains the index of the associated RxPDO mapping object)	UINT16	RW	0x0000 (0 <sub>dec</sub> )
1C12:06	Subindex 006	6. allocated RxPDO (contains the index of the associated RxPDO mapping object)	UINT16	RW	0x0000 (0 <sub>dec</sub> )
1C12:07	Subindex 007	7. allocated RxPDO (contains the index of the associated RxPDO mapping object)	UINT16	RW	0x0000 (0 <sub>dec</sub> )
1C12:08	Subindex 008	8. allocated RxPDO (contains the index of the associated RxPDO mapping object)	UINT16	RW	0x0000 (0 <sub>dec</sub> )

## Index 1C13 TxPDO assign

Index	Name	Meaning	Data type	Flags	Default
1C13:0	TxPDO assign	PDO Assign Inputs	UINT8	RW	0x01 (1 <sub>dec</sub> )
1C13:01	Subindex 001	1. allocated TxPDO (contains the index of the associated TxPDO mapping object)	UINT16	RW	0x1A01 (6657 <sub>dec</sub> )
1C13:02	Subindex 002	2. allocated TxPDO (contains the index of the associated TxPDO mapping object)	UINT16	RW	0x0000 (0 <sub>dec</sub> )
1C13:03	Subindex 003	3. allocated TxPDO (contains the index of the associated TxPDO mapping object)	UINT16	RW	0x0000 (0 <sub>dec</sub> )
1C13:04	Subindex 004	4. allocated TxPDO (contains the index of the associated TxPDO mapping object)	UINT16	RW	0x0000 (0 <sub>dec</sub> )
1C13:05	Subindex 005	5. allocated TxPDO (contains the index of the associated TxPDO mapping object)	UINT16	RW	0x0000 (0 <sub>dec</sub> )
1C13:06	Subindex 006	6. allocated TxPDO (contains the index of the associated TxPDO mapping object)	UINT16	RW	0x0000 (0 <sub>dec</sub> )
1C13:07	Subindex 007	7. allocated TxPDO (contains the index of the associated TxPDO mapping object)	UINT16	RW	0x0000 (0 <sub>dec</sub> )
1C13:08	Subindex 008	8. allocated TxPDO (contains the index of the associated TxPDO mapping object)	UINT16	RW	0x0000 (0 <sub>dec</sub> )
1C13:09	Subindex 009	9. allocated TxPDO (contains the index of the associated TxPDO mapping object)	UINT16	RW	0x0000 (0 <sub>dec</sub> )

**Index 1C32 SM output parameter**

Index	Name	Meaning	Data type	Flags	Default
1C32:0	SM output parameter	Synchronization parameters for the outputs	UINT8	RO	0x20 (32 <sub>dec</sub> )
1C32:01	Sync mode	Current synchronization mode: 0: Free Run 1: Synchron with SM 2 Event 2: DC-Mode - Synchron with SYNC0 Event 3: DC-Mode - Synchron with SYNC1 Event	UINT16	RW	0x0001 (1 <sub>dec</sub> )
1C32:02	Cycle time	Cycle time (in ns): Free Run: cycle time of the local timer Synchronous with SM 2 Event: cycle time of the master DC-Mode: SYNC0/SYNC1 Cycle Time	UINT32	RW	0x000F4240 (1000000 <sub>dec</sub> )
1C32:03	Shift time	Time between SYNC0 event and output of the outputs (in ns, DC mode only)	UINT32	RO	0x00000000 (0 <sub>dec</sub> )
1C32:04	Sync modes supported	Supported synchronization modes: Bit 0 = 1: Free Run is supported Bit 1 = 1: Synchron with SM 2 Event is supported Bit 2-3 = 01: DC-Mode is supported Bit 4-5 = 10: Output Shift with SYNC1 event (only DC mode) Bit 14 = 1: dynamic times (measurement through writing of <a href="#">1C32:08</a> <a href="#">▶ 135</a> )	UINT16	RO	0x440B (17419 <sub>dec</sub> )
1C32:05	Minimum cycle time	Minimum cycle time (in ns)	UINT32	RO	0x000186A0 (100000 <sub>dec</sub> )
1C32:06	Calc and copy time	Minimum time between SYNC0 and SYNC1 event (in ns, DC mode only)	UINT32	RO	0x00000000 (0 <sub>dec</sub> )
1C32:07	Minimum delay time		UINT32	RO	0x00000000 (0 <sub>dec</sub> )
1C32:08	Get Cycle Time	0: Measurement of the local cycle time is stopped 1: Measurement of the local cycle time is started  The entries <a href="#">1C32:03</a> <a href="#">▶ 135</a> , <a href="#">1C32:05</a> <a href="#">▶ 135</a> , <a href="#">1C32:06</a> <a href="#">▶ 135</a> , <a href="#">1C32:09</a> <a href="#">▶ 135</a> , <a href="#">1C33:03</a> <a href="#">▶ 135</a> , <a href="#">1C33:06</a> <a href="#">▶ 135</a> , <a href="#">1C33:09</a> <a href="#">▶ 135</a> are updated with the maximum measured values. For a subsequent measurement the measured values are reset	UINT16	RW	0x0000 (0 <sub>dec</sub> )
1C32:09	Maximum delay time	Time between SYNC1 event and output of the outputs (in ns, DC mode only)	UINT32	RO	0x00000000 (0 <sub>dec</sub> )
1C32:0B	SM event missed counter	Number of missed SM events in OPERATIONAL (DC mode only)	UINT16	RO	0x0000 (0 <sub>dec</sub> )
1C32:0C	Cycle exceeded counter	Number of occasions the cycle time was exceeded in OPERATIONAL (cycle was not completed in time or the next cycle began too early)	UINT16	RO	0x0000 (0 <sub>dec</sub> )
1C32:0D	Shift too short counter	Number of occasions that the interval between SYNC0 and SYNC1 event was too short (DC mode only)	UINT16	RO	0x0000 (0 <sub>dec</sub> )
1C32:20	Sync error	The synchronization was not correct in the last cycle (outputs were output too late; DC mode only)	BOOLEAN	RO	0x00 (0 <sub>dec</sub> )

## Index 1C33 SM input parameter

Index	Name	Meaning	Data type	Flags	Default
1C33:0	SM input parameter	Synchronization parameters for the inputs	UINT8	RO	0x20 (32 <sub>dec</sub> )
1C33:01	Sync mode	Current synchronization mode: 0: Free Run 1: Synchron with SM 3 event (no outputs available) 2: DC - Synchron with SYNC0 Event 3: DC - Synchron with SYNC1 Event 34: Synchron with SM 2 event (outputs available)	UINT16	RW	0x0022 (34 <sub>dec</sub> )
1C33:02	Cycle time	as <a href="#">1C32:02</a> [ <a href="#">▶ 135</a> ]	UINT32	RW	0x000F4240 (1000000 <sub>dec</sub> )
1C33:03	Shift time	Time between SYNC0 event and reading of the inputs (in ns, DC mode only)	UINT32	RO	0x000186A0 (100000 <sub>dec</sub> )
1C33:04	Sync modes supported	Supported synchronization modes: Bit 0: Free Run is supported Bit 1: Synchron with SM 2 Event is supported (outputs available) Bit 1: Synchron with SM 3 Event is supported (no outputs available) Bit 2-3 = 01: DC-Mode is supported Bit 4-5 = 01: Input Shift through local event (outputs available) Bit 4-5 = 10: Input Shift with SYNC1 event (no outputs available) Bit 14 = 1: dynamic times (measurement through writing of <a href="#">1C32:08</a> [ <a href="#">▶ 135</a> ] or <a href="#">1C33:08</a> [ <a href="#">▶ 135</a> ])	UINT16	RO	0x440B (17419 <sub>dec</sub> )
1C33:05	Minimum cycle time	as <a href="#">1C32:05</a> [ <a href="#">▶ 135</a> ]	UINT32	RO	0x000186A0 (100000 <sub>dec</sub> )
1C33:06	Calc and copy time	Time between reading of the inputs and availability of the inputs for the master (in ns, only DC mode)	UINT32	RO	0x00000000 (0 <sub>dec</sub> )
1C33:07	Minimum delay time		UINT32	RO	0x00000000 (0 <sub>dec</sub> )
1C33:08	Get Cycle Time	as <a href="#">1C32:08</a> [ <a href="#">▶ 135</a> ]	UINT16	RW	0x0000 (0 <sub>dec</sub> )
1C33:09	Maximum delay time	Time between SYNC1 event and reading of the inputs (in ns, only DC mode)	UINT32	RO	0x00000000 (0 <sub>dec</sub> )
1C33:0B	SM event missed counter	as <a href="#">1C32:11</a> [ <a href="#">▶ 135</a> ]	UINT16	RO	0x0000 (0 <sub>dec</sub> )
1C33:0C	Cycle exceeded counter	as <a href="#">1C32:12</a> [ <a href="#">▶ 135</a> ]	UINT16	RO	0x0000 (0 <sub>dec</sub> )
1C33:0D	Shift too short counter	as <a href="#">1C32:13</a> [ <a href="#">▶ 135</a> ]	UINT16	RO	0x0000 (0 <sub>dec</sub> )
1C33:20	Sync error	as <a href="#">1C32:32</a> [ <a href="#">▶ 135</a> ]	BOOLEAN	RO	0x00 (0 <sub>dec</sub> )

## 7.1.2.2 Profile-specific objects (0x6000-0xFFFF)

The profile-specific objects have the same meaning for all EtherCAT slaves that support the profile 5001.

## Index 6002 DO Diagnosis Ch.1

Index	Name	Meaning	Data type	Flags	Default
6002:0	DO Diagnosis Ch.1	Process data	UINT8	RO	0x04 (4 <sub>dec</sub> )
6002:01	Overcurrent		BOOLEAN	RO	0x00 (0 <sub>dec</sub> )
6002:02	Overload		BOOLEAN	RO	0x00 (0 <sub>dec</sub> )
6002:03	Open load		BOOLEAN	RO	0x00 (0 <sub>dec</sub> )
6002:04	Short to 24V		BOOLEAN	RO	0x00 (0 <sub>dec</sub> )

**Index 6012 DO Diagnosis Ch.2**

Index	Name	Meaning	Data type	Flags	Default
6012:0	DO Diagnosis Ch.2	Process data	UINT8	RO	0x04 (4 <sub>dec</sub> )
6012:01	Overcurrent		BOOLEAN	RO	0x00 (0 <sub>dec</sub> )
6012:02	Overload		BOOLEAN	RO	0x00 (0 <sub>dec</sub> )
6012:03	Open load		BOOLEAN	RO	0x00 (0 <sub>dec</sub> )
6012:04	Short to 24V		BOOLEAN	RO	0x00 (0 <sub>dec</sub> )

**Index 6022 DO Diagnosis Ch.3**

Index	Name	Meaning	Data type	Flags	Default
6022:0	DO Diagnosis Ch.3	Process data	UINT8	RO	0x04 (4 <sub>dec</sub> )
6022:01	Overcurrent		BOOLEAN	RO	0x00 (0 <sub>dec</sub> )
6022:02	Overload		BOOLEAN	RO	0x00 (0 <sub>dec</sub> )
6022:03	Open load		BOOLEAN	RO	0x00 (0 <sub>dec</sub> )
6022:04	Short to 24V		BOOLEAN	RO	0x00 (0 <sub>dec</sub> )

**Index 6032 DO Diagnosis Ch.4**

Index	Name	Meaning	Data type	Flags	Default
6032:0	DO Diagnosis Ch.4	Process data	UINT8	RO	0x04 (4 <sub>dec</sub> )
6032:01	Overcurrent		BOOLEAN	RO	0x00 (0 <sub>dec</sub> )
6032:02	Overload		BOOLEAN	RO	0x00 (0 <sub>dec</sub> )
6032:03	Open load		BOOLEAN	RO	0x00 (0 <sub>dec</sub> )
6032:04	Short to 24V		BOOLEAN	RO	0x00 (0 <sub>dec</sub> )

**Index 6042 DO Diagnosis Ch.5**

Index	Name	Meaning	Data type	Flags	Default
6042:0	DO Diagnosis Ch.5	Process data	UINT8	RO	0x04 (4 <sub>dec</sub> )
6042:01	Overcurrent		BOOLEAN	RO	0x00 (0 <sub>dec</sub> )
6042:02	Overload		BOOLEAN	RO	0x00 (0 <sub>dec</sub> )
6042:03	Open load		BOOLEAN	RO	0x00 (0 <sub>dec</sub> )
6042:04	Short to 24V		BOOLEAN	RO	0x00 (0 <sub>dec</sub> )

**Index 6052 DO Diagnosis Ch.6**

Index	Name	Meaning	Data type	Flags	Default
6052:0	DO Diagnosis Ch.6	Process data	UINT8	RO	0x04 (4 <sub>dec</sub> )
6052:01	Overcurrent		BOOLEAN	RO	0x00 (0 <sub>dec</sub> )
6052:02	Overload		BOOLEAN	RO	0x00 (0 <sub>dec</sub> )
6052:03	Open load		BOOLEAN	RO	0x00 (0 <sub>dec</sub> )
6052:04	Short to 24V		BOOLEAN	RO	0x00 (0 <sub>dec</sub> )

**Index 6062 DO Diagnosis Ch.7**

Index	Name	Meaning	Data type	Flags	Default
6062:0	DO Diagnosis Ch.7	Process data	UINT8	RO	0x04 (4 <sub>dec</sub> )
6062:01	Overcurrent		BOOLEAN	RO	0x00 (0 <sub>dec</sub> )
6062:02	Overload		BOOLEAN	RO	0x00 (0 <sub>dec</sub> )
6062:03	Open load		BOOLEAN	RO	0x00 (0 <sub>dec</sub> )
6062:04	Short to 24V		BOOLEAN	RO	0x00 (0 <sub>dec</sub> )

**Index 6072 DO Diagnosis Ch.8**

Index	Name	Meaning	Data type	Flags	Default
6072:0	DO Diagnosis Ch.8	Process data	UINT8	RO	0x04 (4 <sub>dec</sub> )
6072:01	Overcurrent		BOOLEAN	RO	0x00 (0 <sub>dec</sub> )
6072:02	Overload		BOOLEAN	RO	0x00 (0 <sub>dec</sub> )
6072:03	Open load		BOOLEAN	RO	0x00 (0 <sub>dec</sub> )
6072:04	Short to 24V		BOOLEAN	RO	0x00 (0 <sub>dec</sub> )

**Index 7000 DO Output Ch.1**

Index	Name	Meaning	Data type	Flags	Default
7000:0	DO Output Ch.1	Process data	UINT8	RO	0x01 (1 <sub>dec</sub> )
7000:01	Output		BOOLEAN	RO	0x00 (0 <sub>dec</sub> )

**Index 7010 DO Output Ch.2**

Index	Name	Meaning	Data type	Flags	Default
7010:0	DO Output Ch.2	Process data	UINT8	RO	0x01 (1 <sub>dec</sub> )
7010:01	Output		BOOLEAN	RO	0x00 (0 <sub>dec</sub> )

**Index 7020 DO Output Ch.3**

Index	Name	Meaning	Data type	Flags	Default
7020:0	DO Output Ch.3	Process data	UINT8	RO	0x01 (1 <sub>dec</sub> )
7020:01	Output		BOOLEAN	RO	0x00 (0 <sub>dec</sub> )

**Index 7030 DO Output Ch.4**

Index	Name	Meaning	Data type	Flags	Default
7030:0	DO Output Ch.4	Process data	UINT8	RO	0x01 (1 <sub>dec</sub> )
7030:01	Output		BOOLEAN	RO	0x00 (0 <sub>dec</sub> )

**Index 7040 DO Output Ch.5**

Index	Name	Meaning	Data type	Flags	Default
7040:0	DO Output Ch.5	Process data	UINT8	RO	0x01 (1 <sub>dec</sub> )
7040:01	Output		BOOLEAN	RO	0x00 (0 <sub>dec</sub> )

**Index 7050 DO Output Ch.6**

Index	Name	Meaning	Data type	Flags	Default
7050:0	DO Output Ch.6	Process data	UINT8	RO	0x01 (1 <sub>dec</sub> )
7050:01	Output		BOOLEAN	RO	0x00 (0 <sub>dec</sub> )

**Index 7060 DO Output Ch.7**

Index	Name	Meaning	Data type	Flags	Default
7060:0	DO Output Ch.7	Process data	UINT8	RO	0x01 (1 <sub>dec</sub> )
7060:01	Output		BOOLEAN	RO	0x00 (0 <sub>dec</sub> )

**Index 7070 DO Output Ch.8**

Index	Name	Meaning	Data type	Flags	Default
7070:0	DO Output Ch.8	Process data	UINT8	RO	0x01 (1 <sub>dec</sub> )
7070:01	Output		BOOLEAN	RO	0x00 (0 <sub>dec</sub> )

**Index 8000 DO Settings Ch.1**

Index	Name	Meaning	Data type	Flags	Default
8000:0	DO Settings Ch.1	Parameters for the digital output channel 1 / connection X01.	UINT8	RO	0x11 (17 <sub>dec</sub> )
8000:01	Detect open wire in off state	Enable wire break detection when the output is switched off. See chapter <a href="#">Enable additional diagnostic functions</a> [▶ 126].	BOOLEAN	RW	0
8000:02	Detect open wire in on state	Enable wire break detection when the output is switched on. See chapter <a href="#">Enable additional diagnostic functions</a> [▶ 126].	BOOLEAN	RW	0
8000:03	Detect short to 24V	Enable detection of short circuits after 24 V. See chapter <a href="#">Enable additional diagnostic functions</a> [▶ 126].	BOOLEAN	RW	0
8000:04	Safe state active	Configuration of the behavior in case of EtherCAT failure.	BOOLEAN	RW	1
8000:05	Safe state value		BOOLEAN	RW	0
8000:11	Safe state delay	See chapter <a href="#">Behavior on EtherCAT failure</a> [▶ 121].	UINT16	RW	0

**Index 8010 DO Settings Ch.2**

Index	Name	Meaning	Data type	Flags	Default
8010:0	DO Settings Ch.2	Parameters for the digital output channel 2 / connection X02.	UINT8	RO	0x11 (17 <sub>dec</sub> )
8010:01	Detect open wire in off state	Enable wire break detection when the output is switched off. See chapter <a href="#">Enable additional diagnostic functions</a> [▶ 126].	BOOLEAN	RW	0
8010:02	Detect open wire in on state	Enable wire break detection when the output is switched on. See chapter <a href="#">Enable additional diagnostic functions</a> [▶ 126].	BOOLEAN	RW	0
8010:03	Detect short to 24V	Enable detection of short circuits after 24 V. See chapter <a href="#">Enable additional diagnostic functions</a> [▶ 126].	BOOLEAN	RW	0
8010:04	Safe state active	Configuration of the behavior in case of EtherCAT failure.	BOOLEAN	RW	1
8010:05	Safe state value		BOOLEAN	RW	0
8010:11	Safe state delay	See chapter <a href="#">Behavior on EtherCAT failure</a> [▶ 121].	UINT16	RW	0

**Index 8020 DO Settings Ch.3**

Index	Name	Meaning	Data type	Flags	Default
8020:0	DO Settings Ch.3	Parameters for the digital output channel 3 / connection X03.	UINT8	RO	0x11 (17 <sub>dec</sub> )
8020:01	Detect open wire in off state	Enable wire break detection when the output is switched off. See chapter <a href="#">Enable additional diagnostic functions</a> [▶ 126].	BOOLEAN	RW	0
8020:02	Detect open wire in on state	Enable wire break detection when the output is switched on. See chapter <a href="#">Enable additional diagnostic functions</a> [▶ 126].	BOOLEAN	RW	0
8020:03	Detect short to 24V	Enable detection of short circuits after 24 V. See chapter <a href="#">Enable additional diagnostic functions</a> [▶ 126].	BOOLEAN	RW	0
8020:04	Safe state active	Configuration of the behavior in case of EtherCAT failure.	BOOLEAN	RW	1
8020:05	Safe state value		BOOLEAN	RW	0
8020:11	Safe state delay	See chapter <a href="#">Behavior on EtherCAT failure</a> [▶ 121].	UINT16	RW	0

## Index 8030 DO Settings Ch.4

Index	Name	Meaning	Data type	Flags	Default
8030:0	DO Settings Ch.4	Parameters for the digital output channel 4 / connection X04.	UINT8	RO	0x11 (17 <sub>dec</sub> )
8030:01	Detect open wire in off state	Enable wire break detection when the output is switched off. See chapter <a href="#">Enable additional diagnostic functions</a> [▶ 126].	BOOLEAN	RW	0
8030:02	Detect open wire in on state	Enable wire break detection when the output is switched on. See chapter <a href="#">Enable additional diagnostic functions</a> [▶ 126].	BOOLEAN	RW	0
8030:03	Detect short to 24V	Enable detection of short circuits after 24 V. See chapter <a href="#">Enable additional diagnostic functions</a> [▶ 126].	BOOLEAN	RW	0
8030:04	Safe state active	Configuration of the behavior in case of EtherCAT failure.	BOOLEAN	RW	1
8030:05	Safe state value		BOOLEAN	RW	0
8030:11	Safe state delay	See chapter <a href="#">Behavior on EtherCAT failure</a> [▶ 121].	UINT16	RW	0

## Index 8040 DO Settings Ch.5

Index	Name	Meaning	Data type	Flags	Default
8040:0	DO Settings Ch.5	Parameters for the digital output channel 5 / connection X05.	UINT8	RO	0x11 (17 <sub>dec</sub> )
8040:01	Detect open wire in off state	Enable wire break detection when the output is switched off. See chapter <a href="#">Enable additional diagnostic functions</a> [▶ 126].	BOOLEAN	RW	0
8040:02	Detect open wire in on state	Enable wire break detection when the output is switched on. See chapter <a href="#">Enable additional diagnostic functions</a> [▶ 126].	BOOLEAN	RW	0
8040:03	Detect short to 24V	Enable detection of short circuits after 24 V. See chapter <a href="#">Enable additional diagnostic functions</a> [▶ 126].	BOOLEAN	RW	0
8040:04	Safe state active	Configuration of the behavior in case of EtherCAT failure.	BOOLEAN	RW	1
8040:05	Safe state value		BOOLEAN	RW	0
8040:11	Safe state delay	See chapter <a href="#">Behavior on EtherCAT failure</a> [▶ 121].	UINT16	RW	0

## Index 8050 DO Settings Ch.6

Index	Name	Meaning	Data type	Flags	Default
8050:0	DO Settings Ch.6	Parameters for the digital output channel 6 / connection X06.	UINT8	RO	0x11 (17 <sub>dec</sub> )
8050:01	Detect open wire in off state	Enable wire break detection when the output is switched off. See chapter <a href="#">Enable additional diagnostic functions</a> [▶ 126].	BOOLEAN	RW	0
8050:02	Detect open wire in on state	Enable wire break detection when the output is switched on. See chapter <a href="#">Enable additional diagnostic functions</a> [▶ 126].	BOOLEAN	RW	0
8050:03	Detect short to 24V	Enable detection of short circuits after 24 V. See chapter <a href="#">Enable additional diagnostic functions</a> [▶ 126].	BOOLEAN	RW	0
8050:04	Safe state active	Configuration of the behavior in case of EtherCAT failure.	BOOLEAN	RW	1
8050:05	Safe state value		BOOLEAN	RW	0
8050:11	Safe state delay	See chapter <a href="#">Behavior on EtherCAT failure</a> [▶ 121].	UINT16	RW	0



**Index 8060 DO Settings Ch.7**

Index	Name	Meaning	Data type	Flags	Default
8060:0	DO Settings Ch.7	Parameters for the digital output channel 7 / connection X07.	UINT8	RO	0x11 (17 <sub>dec</sub> )
8060:01	Detect open wire in off state	Enable wire break detection when the output is switched off. See chapter <a href="#">Enable additional diagnostic functions</a> [▶ 126].	BOOLEAN	RW	0
8060:02	Detect open wire in on state	Enable wire break detection when the output is switched on. See chapter <a href="#">Enable additional diagnostic functions</a> [▶ 126].	BOOLEAN	RW	0
8060:03	Detect short to 24V	Enable detection of short circuits after 24 V. See chapter <a href="#">Enable additional diagnostic functions</a> [▶ 126].	BOOLEAN	RW	0
8060:04	Safe state active	Configuration of the behavior in case of EtherCAT failure.	BOOLEAN	RW	1
8060:05	Safe state value		BOOLEAN	RW	0
8060:11	Safe state delay	See chapter <a href="#">Behavior on EtherCAT failure</a> [▶ 121].	UINT16	RW	0

**Index 8070 DO Settings Ch.8**

Index	Name	Meaning	Data type	Flags	Default
8070:0	DO Settings Ch.8	Parameters for the digital output channel 8 / connection X08.	UINT8	RO	0x11 (17 <sub>dec</sub> )
8070:01	Detect open wire in off state	Enable wire break detection when the output is switched off. See chapter <a href="#">Enable additional diagnostic functions</a> [▶ 126].	BOOLEAN	RW	0
8070:02	Detect open wire in on state	Enable wire break detection when the output is switched on. See chapter <a href="#">Enable additional diagnostic functions</a> [▶ 126].	BOOLEAN	RW	0
8070:03	Detect short to 24V	Enable detection of short circuits after 24 V. See chapter <a href="#">Enable additional diagnostic functions</a> [▶ 126].	BOOLEAN	RW	0
8070:04	Safe state active	Configuration of the behavior in case of EtherCAT failure.	BOOLEAN	RW	1
8070:05	Safe state value		BOOLEAN	RW	0
8070:11	Safe state delay	See chapter <a href="#">Behavior on EtherCAT failure</a> [▶ 121].	UINT16	RW	0

**Index F000 Modular Device Profile**

Index	Name	Meaning	Data type	Flags	Default
F000:0	Modular Device Profile	General information for the modular device profile	UINT8	RO	0x02 (2 <sub>dec</sub> )
F000:01	Index distance	Index distance of the objects of the individual channels	UINT16	RO	0x0010 (16 <sub>dec</sub> )
F000:02	Maximum number of modules	Number of channels.	UINT16	RO	0x0008 (8 <sub>dec</sub> )

**Index F008 Code word**

Index	Name	Meaning	Data type	Flags	Default
F008:0	Code word	reserved	UINT32	RW	0x00000000 (0 <sub>dec</sub> )

**Index F600 DEV Inputs**

Index	Name	Meaning	Data type	Flags	Default
F600:0	DEV Inputs	Process data	UINT8	RO	0x0F (15 <sub>dec</sub> )
F600:01	Undervoltage Us		BOOLEAN	RO	0x00 (0 <sub>dec</sub> )
F600:02	Undervoltage Up		BOOLEAN	RO	0x00 (0 <sub>dec</sub> )
F600:03	Overtemperature		BOOLEAN	RO	0x00 (0 <sub>dec</sub> )
F600:0D	Diag		BOOLEAN	RO	0x00 (0 <sub>dec</sub> )
F600:0E	TxPDO State		BOOLEAN	RO	0x00 (0 <sub>dec</sub> )
F600:0F	Input cycle counter		BIT2	RO	0x00 (0 <sub>dec</sub> )

**Index F800 DEV Settings**

Index	Name	Meaning	Data type	Flags	Default
F800:0	DEV Settings		UINT8	RO	0x12 (18 <sub>dec</sub> )
F800:10	Us undervoltage detection threshold	reserved	UINT16	RW	0x0000 (0 <sub>dec</sub> )
F800:12	Up undervoltage detection threshold	reserved	UINT16	RW	0x0000 (0 <sub>dec</sub> )

**Index F900 DEV Info data**

Index	Name	Meaning	Data type	Flags	Default
F900:0	DEV Info data		UINT8	RO	0x05 (5 <sub>dec</sub> )
F900:02	Internal Temperature		INT8	RO	0x00 (0 <sub>dec</sub> )
F900:04	Voltage Us		UINT16	RO	0x0000 (0 <sub>dec</sub> )
F900:05	Voltage Up		UINT16	RO	0x0000 (0 <sub>dec</sub> )

**Index FB00 DEV Command**

Index	Name	Meaning	Data type	Flags	Default
FB00:0	DEV Command	Command interface	UINT8	RO	0x03 (3 <sub>dec</sub> )
FB00:01	Request	Request	OCTET-STRING[2]	RW	{0}
FB00:02	Status	Status	UINT8	RO	0x00 (0 <sub>dec</sub> )
FB00:03	Response	Response	OCTET-STRING[8]	RW	{0}

## 7.2 EP2816-0008

### 7.2.1 Object overview

#### ● EtherCAT XML Device Description

**i** The display matches that of the CoE objects from the EtherCAT XML Device Description. We recommend downloading the latest XML file from the download area of the Beckhoff website and installing it according to installation instructions.

Index	Name	Flags	Default value	
1000 <a href="#">▶ 154</a>	Device type	RO	0x01181389 (18355081 <sub>dec</sub> )	
1008 <a href="#">▶ 155</a>	Device name	RO	EP2816-0008	
1009 <a href="#">▶ 155</a>	Hardware version	RO	02	
100A <a href="#">▶ 155</a>	Software version	RO	05	
1011:0 <a href="#">▶ 152</a>	<b>Subindex</b>	Restore default parameters	RO	0x01 (1 <sub>dec</sub> )
	1011:01	SubIndex 001	RW	0x00000000 (0 <sub>dec</sub> )
1018:0 <a href="#">▶ 155</a>	<b>Subindex</b>	Identity	RO	0x04 (4 <sub>dec</sub> )
	1018:01	Vendor ID	RO	0x00000002 (2 <sub>dec</sub> )
	1018:02	Product code	RO	0x0B004052 (184565842 <sub>dec</sub> )
	1018:03	Revision	RO	0x00130008 (1245192 <sub>dec</sub> )
	1018:04	Serial number	RO	0x00000000 (0 <sub>dec</sub> )
10F0:0 <a href="#">▶ 155</a>	<b>Subindex</b>	Backup parameter handling	RO	0x01 (1 <sub>dec</sub> )
	10F0:01	Checksum	RO	0x00000000 (0 <sub>dec</sub> )
1600:0 <a href="#">▶ 155</a>	<b>Subindex</b>	DIG RxPDO-Map Outputs Ch.1	RO	0x09 (9 <sub>dec</sub> )
	1600:01	SubIndex 001	RO	0x7000:01, 1
	1600:02	SubIndex 002	RO	0x7000:02, 1
	1600:03	SubIndex 003	RO	0x7000:03, 1
	1600:04	SubIndex 004	RO	0x7000:04, 1
	1600:05	SubIndex 005	RO	0x7000:05, 1
	1600:06	SubIndex 006	RO	0x7000:06, 1
	1600:07	SubIndex 007	RO	0x7000:07, 1
	1600:08	SubIndex 008	RO	0x7000:08, 1
	1600:09	SubIndex 009	RO	0x0000:00, 8
1601:0 <a href="#">▶ 156</a>	<b>Subindex</b>	DIG RxPDO-Map Outputs Ch.2	RO	0x09 (9 <sub>dec</sub> )
	1601:01	SubIndex 001	RO	0x7010:01, 1
	1601:02	SubIndex 002	RO	0x7010:02, 1
	1601:03	SubIndex 003	RO	0x7010:03, 1
	1601:04	SubIndex 004	RO	0x7010:04, 1
	1601:05	SubIndex 005	RO	0x7010:05, 1
	1601:06	SubIndex 006	RO	0x7010:06, 1
	1601:07	SubIndex 007	RO	0x7010:07, 1
	1601:08	SubIndex 008	RO	0x7010:08, 1
	1601:09	SubIndex 009	RO	0x0000:00, 8
1602:0 <a href="#">▶ 156</a>	<b>Subindex</b>	DIG RxPDO-Map Outputs Device	RO	0x03 (3 <sub>dec</sub> )
	1602:01	SubIndex 001	RO	0xF700:01, 1
	1602:02	SubIndex 002	RO	0xF700:02, 1
	1602:03	SubIndex 003	RO	0x0000:00, 14

Index		Name	Flags	Default value
1A00:0 [▶ 156]	<b>Subindex</b>	DIG TxPDO-Map Diag Inputs Ch.1	RO	0x09 (9 <sub>dec</sub> )
	1A00:01	SubIndex 001	RO	0x6001:01, 1
	1A00:02	SubIndex 002	RO	0x6001:02, 1
	1A00:03	SubIndex 003	RO	0x6001:03, 1
	1A00:04	SubIndex 004	RO	0x6001:04, 1
	1A00:05	SubIndex 005	RO	0x6001:05, 1
	1A00:06	SubIndex 006	RO	0x6001:06, 1
	1A00:07	SubIndex 007	RO	0x6001:07, 1
	1A00:08	SubIndex 008	RO	0x6001:08, 1
	1A00:09	SubIndex 009	RO	0x0000:00, 8
1A01:0 [▶ 157]	<b>Subindex</b>	DIG TxPDO-Map Diag Inputs Ch.2	RO	0x09 (9 <sub>dec</sub> )
	1A01:01	SubIndex 001	RO	0x6011:01, 1
	1A01:02	SubIndex 002	RO	0x6011:02, 1
	1A01:03	SubIndex 003	RO	0x6011:03, 1
	1A01:04	SubIndex 004	RO	0x6011:04, 1
	1A01:05	SubIndex 005	RO	0x6011:05, 1
	1A01:06	SubIndex 006	RO	0x6011:06, 1
	1A01:07	SubIndex 007	RO	0x6011:07, 1
	1A01:08	SubIndex 008	RO	0x6011:08, 1
	1A01:09	SubIndex 009	RO	0x0000:00, 8
1A02:0 [▶ 157]	<b>Subindex</b>	DIG TxPDO-Map Inputs Device	RO	0x07 (7 <sub>dec</sub> )
	1A02:01	SubIndex 001	RO	0xF600:01, 1
	1A02:02	SubIndex 002	RO	0xF600:02, 1
	1A02:03	SubIndex 003	RO	0xF600:03, 1
	1A02:04	SubIndex 004	RO	0x0000:00, 10
	1A02:05	SubIndex 005	RO	0x1C32:20, 1
	1A02:06	SubIndex 006	RO	0x0000:00, 1
	1A02:07	SubIndex 007	RO	0x1800:09, 1
1C00:0 [▶ 157]	<b>Subindex</b>	Sync manager type	RO	0x04 (4 <sub>dec</sub> )
	1C00:01	SubIndex 001	RO	0x01 (1 <sub>dec</sub> )
	1C00:02	SubIndex 002	RO	0x02 (2 <sub>dec</sub> )
	1C00:03	SubIndex 003	RO	0x03 (3 <sub>dec</sub> )
	1C00:04	SubIndex 004	RO	0x04 (4 <sub>dec</sub> )
1C12:0 [▶ 157]	<b>Subindex</b>	RxPDO assign	RW	0x03 (3 <sub>dec</sub> )
	1C12:01	SubIndex 001	RW	0x1600 (5632 <sub>dec</sub> )
	1C12:02	SubIndex 002	RW	0x1601 (5633 <sub>dec</sub> )
	1C12:03	SubIndex 003	RW	0x1602 (5634 <sub>dec</sub> )
1C13:0 [▶ 158]	<b>Subindex</b>	TxPDO assign	RW	0x03 (3 <sub>dec</sub> )
	1C13:01	SubIndex 001	RW	0x1A00 (6656 <sub>dec</sub> )
	1C13:02	SubIndex 002	RW	0x1A01 (6657 <sub>dec</sub> )
	1C13:03	SubIndex 003	RW	0x1A02 (6658 <sub>dec</sub> )
1C32:0 [▶ 158]	<b>Subindex</b>	SM output parameter	RO	0x20 (32 <sub>dec</sub> )
	1C32:01	Sync mode	RW	0x0001 (1 <sub>dec</sub> )
	1C32:02	Cycle time	RW	0x000F4240 (1000000 <sub>dec</sub> )
	1C32:03	Shift time	RO	0x00020F58 (135000 <sub>dec</sub> )
	1C32:04	Sync modes supported	RO	0xC007 (49159 <sub>dec</sub> )
	1C32:05	Minimum cycle time	RO	0x00030D40 (200000 <sub>dec</sub> )
	1C32:06	Calc and copy time	RO	0x00000000 (0 <sub>dec</sub> )
	1C32:07	Minimum delay time	RO	0x00020F58 (135000 <sub>dec</sub> )
	1C32:08	Command	RW	0x0000 (0 <sub>dec</sub> )
	1C32:09	Maximum Delay time	RO	0x00020F58 (135000 <sub>dec</sub> )
	1C32:0B	SM event missed counter	RO	0x0000 (0 <sub>dec</sub> )
	1C32:0C	Cycle exceeded counter	RO	0x0000 (0 <sub>dec</sub> )
	1C32:0D	Shift too short counter	RO	0x0000 (0 <sub>dec</sub> )
	1C32:20	Sync error	RO	0x00 (0 <sub>dec</sub> )

Index	Name	Flags	Default value	
1C33:0 [▶ 159]	<b>Subindex</b>	SM input parameter	RO	0x20 (32 <sub>dec</sub> )
	1C33:01	Sync mode	RW	0x0022 (34 <sub>dec</sub> )
	1C33:02	Cycle time	RW	0x000F4240 (1000000 <sub>dec</sub> )
	1C33:03	Shift time	RO	0x00000000 (0 <sub>dec</sub> )
	1C33:04	Sync modes supported	RO	0xC007 (49159 <sub>dec</sub> )
	1C33:05	Minimum cycle time	RO	0x00030D40 (200000 <sub>dec</sub> )
	1C33:06	Calc and copy time	RO	0x00000000 (0 <sub>dec</sub> )
	1C33:07	Minimum delay time	RO	0x00000000 (0 <sub>dec</sub> )
	1C33:08	Command	RW	0x0000 (0 <sub>dec</sub> )
	1C33:09	Maximum Delay time	RO	0x00000000 (0 <sub>dec</sub> )
	1C33:0B	SM event missed counter	RO	0x0000 (0 <sub>dec</sub> )
	1C33:0C	Cycle exceeded counter	RO	0x0000 (0 <sub>dec</sub> )
	1C33:0D	Shift too short counter	RO	0x0000 (0 <sub>dec</sub> )
1C33:20	Sync error	RO	0x00 (0 <sub>dec</sub> )	
6001:0 [▶ 159]	<b>Subindex</b>	DIG Diag Inputs Ch.1	RO	0x08 (8 <sub>dec</sub> )
	6001:01	Diag Input 1	RO	0x00 (0 <sub>dec</sub> )
	6001:02	Diag Input 2	RO	0x00 (0 <sub>dec</sub> )
	6001:03	Diag Input 3	RO	0x00 (0 <sub>dec</sub> )
	6001:04	Diag Input 4	RO	0x00 (0 <sub>dec</sub> )
	6001:05	Diag Input 5	RO	0x00 (0 <sub>dec</sub> )
	6001:06	Diag Input 6	RO	0x00 (0 <sub>dec</sub> )
	6001:07	Diag Input 7	RO	0x00 (0 <sub>dec</sub> )
	6001:08	Diag Input 8	RO	0x00 (0 <sub>dec</sub> )
6011:0 [▶ 160]	<b>Subindex</b>	DIG Diag Inputs Ch.2	RO	0x08 (8 <sub>dec</sub> )
	6011:01	Diag Input 1	RO	0x00 (0 <sub>dec</sub> )
	6011:02	Diag Input 2	RO	0x00 (0 <sub>dec</sub> )
	6011:03	Diag Input 3	RO	0x00 (0 <sub>dec</sub> )
	6011:04	Diag Input 4	RO	0x00 (0 <sub>dec</sub> )
	6011:05	Diag Input 5	RO	0x00 (0 <sub>dec</sub> )
	6011:06	Diag Input 6	RO	0x00 (0 <sub>dec</sub> )
	6011:07	Diag Input 7	RO	0x00 (0 <sub>dec</sub> )
	6011:08	Diag Input 8	RO	0x00 (0 <sub>dec</sub> )
7000:0 [▶ 160]	<b>Subindex</b>	DIG Outputs Ch.1	RO	0x08 (8 <sub>dec</sub> )
	7000:01	Output 1	RO	0x00 (0 <sub>dec</sub> )
	7000:02	Output 2	RO	0x00 (0 <sub>dec</sub> )
	7000:03	Output 3	RO	0x00 (0 <sub>dec</sub> )
	7000:04	Output 4	RO	0x00 (0 <sub>dec</sub> )
	7000:05	Output 5	RO	0x00 (0 <sub>dec</sub> )
	7000:06	Output 6	RO	0x00 (0 <sub>dec</sub> )
	7000:07	Output 7	RO	0x00 (0 <sub>dec</sub> )
	7000:08	Output 8	RO	0x00 (0 <sub>dec</sub> )
7010:0 [▶ 160]	<b>Subindex</b>	DIG Outputs Ch.2	RO	0x08 (8 <sub>dec</sub> )
	7010:01	Output 1	RO	0x00 (0 <sub>dec</sub> )
	7010:02	Output 2	RO	0x00 (0 <sub>dec</sub> )
	7010:03	Output 3	RO	0x00 (0 <sub>dec</sub> )
	7010:04	Output 4	RO	0x00 (0 <sub>dec</sub> )
	7010:05	Output 5	RO	0x00 (0 <sub>dec</sub> )
	7010:06	Output 6	RO	0x00 (0 <sub>dec</sub> )
	7010:07	Output 7	RO	0x00 (0 <sub>dec</sub> )
	7010:08	Output 8	RO	0x00 (0 <sub>dec</sub> )

Index		Name	Flags	Default value
8000:0 [▶ 152]	<b>Subindex</b>	DIG Safe state active Ch.1	RW	0x08 (8 <sub>dec</sub> )
	8000:01	Output 1	RW	0x01 (1 <sub>dec</sub> )
	8000:02	Output 2	RW	0x01 (1 <sub>dec</sub> )
	8000:03	Output 3	RW	0x01 (1 <sub>dec</sub> )
	8000:04	Output 4	RW	0x01 (1 <sub>dec</sub> )
	8000:05	Output 5	RW	0x01 (1 <sub>dec</sub> )
	8000:06	Output 6	RW	0x01 (1 <sub>dec</sub> )
	8000:07	Output 7	RW	0x01 (1 <sub>dec</sub> )
	8000:08	Output 8	RW	0x01 (1 <sub>dec</sub> )
8001:0 [▶ 153]	<b>Subindex</b>	DIG Safe state value Ch.1	RW	0x08 (8 <sub>dec</sub> )
	8001:01	Output 1	RW	0x00 (0 <sub>dec</sub> )
	8001:02	Output 2	RW	0x00 (0 <sub>dec</sub> )
	8001:03	Output 3	RW	0x00 (0 <sub>dec</sub> )
	8001:04	Output 4	RW	0x00 (0 <sub>dec</sub> )
	8001:05	Output 5	RW	0x00 (0 <sub>dec</sub> )
	8001:06	Output 6	RW	0x00 (0 <sub>dec</sub> )
	8001:07	Output 7	RW	0x00 (0 <sub>dec</sub> )
	8001:08	Output 8	RW	0x00 (0 <sub>dec</sub> )
8010:0 [▶ 153]	<b>Subindex</b>	DIG Safe state active Ch.2	RW	0x08 (8 <sub>dec</sub> )
	8010:01	Output 9	RW	0x01 (1 <sub>dec</sub> )
	8010:02	Output 10	RW	0x01 (1 <sub>dec</sub> )
	8010:03	Output 11	RW	0x01 (1 <sub>dec</sub> )
	8010:04	Output 12	RW	0x01 (1 <sub>dec</sub> )
	8010:05	Output 13	RW	0x01 (1 <sub>dec</sub> )
	8010:06	Output 14	RW	0x01 (1 <sub>dec</sub> )
	8010:07	Output 15	RW	0x01 (1 <sub>dec</sub> )
	8010:08	Output 16	RW	0x01 (1 <sub>dec</sub> )
8011:0 [▶ 154]	<b>Subindex</b>	DIG Safe state value Ch.2	RW	0x08 (8 <sub>dec</sub> )
	8011:01	Output 9	RW	0x00 (0 <sub>dec</sub> )
	8011:02	Output 10	RW	0x00 (0 <sub>dec</sub> )
	8011:03	Output 11	RW	0x00 (0 <sub>dec</sub> )
	8011:04	Output 12	RW	0x00 (0 <sub>dec</sub> )
	8011:05	Output 13	RW	0x00 (0 <sub>dec</sub> )
	8011:06	Output 14	RW	0x00 (0 <sub>dec</sub> )
	8011:07	Output 15	RW	0x00 (0 <sub>dec</sub> )
	8011:08	Output 16	RW	0x00 (0 <sub>dec</sub> )
F000:0 [▶ 160]	<b>Subindex</b>	Modular device profile	RO	0x02 (2 <sub>dec</sub> )
	F000:01	Module index distance	RO	0x0010 (16 <sub>dec</sub> )
	F000:02	Maximum number of modules	RO	0x0002 (2 <sub>dec</sub> )
F008 [▶ 160]		Code word	RW	0x00000000 (0 <sub>dec</sub> )
F010:0 [▶ 161]	<b>Subindex</b>	Module list	RW	0x02 (2 <sub>dec</sub> )
	F010:01	SubIndex 001	RW	0x00000118 (280 <sub>dec</sub> )
	F010:02	SubIndex 002	RW	0x00000118 (280 <sub>dec</sub> )
F600:0 [▶ 161]	<b>Subindex</b>	DIG Inputs	RO	0x10 (16 <sub>dec</sub> )
	F600:01	Safe state active	RO	0x00 (0 <sub>dec</sub> )
	F600:02	Error channel 1	RO	0x00 (0 <sub>dec</sub> )
	F600:03	Error channel 2	RO	0x00 (0 <sub>dec</sub> )
	F600:0E	Sync error	RO	0x00 (0 <sub>dec</sub> )
	F600:10	TxPDO Toggle	RO	0x00 (0 <sub>dec</sub> )
F700:0 [▶ 161]	<b>Subindex</b>	DIG Outputs	RO	0x02 (2 <sub>dec</sub> )
	F700:01	Set safe state	RO	0x00 (0 <sub>dec</sub> )
	F700:02	Reset outputs	RO	0x00 (0 <sub>dec</sub> )
F800:0 [▶ 161]	<b>Subindex</b>	DIG Settings	RW	0x11 (17 <sub>dec</sub> )
	F800:01	Disable shut off	RW	0x00 (0 <sub>dec</sub> )
	F800:11	Switch off time	RW	0x03E8 (1000 <sub>dec</sub> )

**Key**

Flags:

RO = Read only

RW = Read/Write

## 7.2.2 Object description and parameterization

### ● Parameterization

**i** The terminal is parameterized via the CoE - Online tab (double-click on the respective object) or via the Process Data tab (assignment of PDOs).

### ● EtherCAT XML Device Description

**i** The display matches that of the CoE objects from the EtherCAT XML Device Description. It is strongly recommended to download the latest revision of the corresponding XML file from the Beckhoff website (<http://www.beckhoff.com/english/default.htm?download/elconfg.htm>) and follow the installation instructions.

### Introduction

The CoE overview contains objects for different intended applications:

- [Objects required for parameterization \[► 152\]](#) during commissioning
- [Objects intended for regular operation \[► 154\]](#), e.g. through ADS access
- [Objects for indicating internal settings \[► 154\]](#) (may be fixed)
- Further [profile-specific objects \[► 159\]](#) indicating inputs, outputs and status information

The following section first describes the objects required for normal operation, followed by a complete overview of missing objects.

### Objects to be parameterized during commissioning

#### Index 1011 Restore default parameters

Index	Name	Meaning	Data type	Flags	Default
1011:0	Restore default parameters	Restore default settings	UINT8	RO	0x01 (1 <sub>dec</sub> )
1011:01	SubIndex 001	If this object is set to " <b>0x64616F6C</b> " in the Set Value Dialog, all backup objects are reset to their delivery state.	UINT32	RW	0x00000000 (0 <sub>dec</sub> )

#### Index 8000 DIG Safe state active Ch.1

The outputs for which the *DIG Safe state active* bit is set are switched to the values specified in *Safe state value* in the event that the Operational (OP) status is left.

Status Operational (OP) is left if communication to the master is interrupted, for example at power breakdown at the master or cable breakage.



Index	Name	Meaning	Data type	Flags	Default
8000:0	DIG Safe state active		UINT8	RO	0x08 (8 <sub>dec</sub> )
8000:01	Output 1	0 <sub>bin</sub> : DIG Safe state for output 1 is switched off 1 <sub>bin</sub> : DIG Safe state for output 1 is switched on	boolean	RW	1 <sub>bin</sub>
8000:02	Output 2	0 <sub>bin</sub> : DIG Safe state for output 2 is switched off 1 <sub>bin</sub> : DIG Safe state for output 2 is switched on	boolean	RW	1 <sub>bin</sub>
8000:03	Output 3	0 <sub>bin</sub> : DIG Safe state for output 3 is switched off 1 <sub>bin</sub> : DIG Safe state for output 3 is switched on	boolean	RW	1 <sub>bin</sub>
8000:04	Output 4	0 <sub>bin</sub> : DIG Safe state for output 4 is switched off 1 <sub>bin</sub> : DIG Safe state for output 4 is switched on	boolean	RW	1 <sub>bin</sub>
8000:05	Output 5	0 <sub>bin</sub> : DIG Safe state for output 5 is switched off 1 <sub>bin</sub> : DIG Safe state for output 5 is switched on	boolean	RW	1 <sub>bin</sub>
8000:06	Output 6	0 <sub>bin</sub> : DIG Safe state for output 6 is switched off 1 <sub>bin</sub> : DIG Safe state for output 6 is switched on	boolean	RW	1 <sub>bin</sub>
8000:07	Output 7	0 <sub>bin</sub> : DIG Safe state for output 7 is switched off 1 <sub>bin</sub> : DIG Safe state for output 7 is switched on	boolean	RW	1 <sub>bin</sub>
8000:08	Output 8	0 <sub>bin</sub> : DIG Safe state for output 8 is switched off 1 <sub>bin</sub> : DIG Safe state for output 8 is switched on	boolean	RW	1 <sub>bin</sub>

### Index 8001 DIG Safe state value Ch.1

The values to which the outputs are switched when the status Operational (OP) is left are specified here.

Index	Name	Meaning	Data type	Flags	Default
8001:0	DIG Safe state value		UINT8	RO	0x08 (8 <sub>dec</sub> )
8001:01	Output 1	0 <sub>bin</sub> : DIG Safe state value for output 1 = 0 1 <sub>bin</sub> : DIG Safe state value for output 1 = 1	boolean	RW	0x00 (0 <sub>dec</sub> )
8001:02	Output 2	0 <sub>bin</sub> : DIG Safe state value for output 2 = 0 1 <sub>bin</sub> : DIG Safe state value for output 2 = 1	boolean	RW	0x00 (0 <sub>dec</sub> )
8001:03	Output 3	0 <sub>bin</sub> : DIG Safe state value for output 3 = 0 1 <sub>bin</sub> : DIG Safe state value for output 3 = 1	boolean	RW	0x00 (0 <sub>dec</sub> )
8001:04	Output 4	0 <sub>bin</sub> : DIG Safe state value for output 4 = 0 1 <sub>bin</sub> : DIG Safe state value for output 4 = 1	boolean	RW	0x00 (0 <sub>dec</sub> )
8001:05	Output 5	0 <sub>bin</sub> : DIG Safe state value for output 5 = 0 1 <sub>bin</sub> : DIG Safe state value for output 5 = 1	boolean	RW	0x00 (0 <sub>dec</sub> )
8001:06	Output 6	0 <sub>bin</sub> : DIG Safe state value for output 6 = 0 1 <sub>bin</sub> : DIG Safe state value for output 6 = 1	boolean	RW	0x00 (0 <sub>dec</sub> )
8001:07	Output 7	0 <sub>bin</sub> : DIG Safe state value for output 7 = 0 1 <sub>bin</sub> : DIG Safe state value for output 7 = 1	boolean	RW	0x00 (0 <sub>dec</sub> )
8001:08	Output 8	0 <sub>bin</sub> : DIG Safe state value for output 8 = 0 1 <sub>bin</sub> : DIG Safe state value for output 8 = 1	boolean	RW	0x00 (0 <sub>dec</sub> )

### Index 8010 DIG Safe state active Ch.2

The outputs for which the *DIG Safe state active* bit is set are switched to the values specified in *Safe state value* in the event that the Operational (OP) status is left.

Status Operational (OP) is left if communication to the master is interrupted, for example at power breakdown at the master or wire breakage.

Index	Name	Meaning	Data type	Flags	Default
8010:0	DIG Safe state active		UINT8	RO	0x08 (8 <sub>dec</sub> )
8010:01	Output 9	0 <sub>bin</sub> : DIG Safe state for output 9 is switched off 1 <sub>bin</sub> : DIG Safe state for output 9 is switched on	boolean	RW	1 <sub>bin</sub>
8010:02	Output 10	0 <sub>bin</sub> : DIG Safe state for output 10 is switched off 1 <sub>bin</sub> : DIG Safe state for output 10 is switched on	boolean	RW	1 <sub>bin</sub>
8010:03	Output 11	0 <sub>bin</sub> : DIG Safe state for output 11 is switched off 1 <sub>bin</sub> : DIG Safe state for output 11 is switched on	boolean	RW	1 <sub>bin</sub>
8010:04	Output 12	0 <sub>bin</sub> : DIG Safe state for output 12 is switched off 1 <sub>bin</sub> : DIG Safe state for output 12 is switched on	boolean	RW	1 <sub>bin</sub>
8010:05	Output 13	0 <sub>bin</sub> : DIG Safe state for output 13 is switched off 1 <sub>bin</sub> : DIG Safe state for output 13 is switched on	boolean	RW	1 <sub>bin</sub>
8010:06	Output 14	0 <sub>bin</sub> : DIG Safe state for output 14 is switched off 1 <sub>bin</sub> : DIG Safe state for output 14 is switched on	boolean	RW	1 <sub>bin</sub>
8010:07	Output 15	0 <sub>bin</sub> : DIG Safe state for output 15 is switched off 1 <sub>bin</sub> : DIG Safe state for output 15 is switched on	boolean	RW	1 <sub>bin</sub>
8010:08	Output 16	0 <sub>bin</sub> : DIG Safe state for output 16 is switched off 1 <sub>bin</sub> : DIG Safe state for output 16 is switched on	boolean	RW	1 <sub>bin</sub>

### Index 8011 DIG Safe state value Ch.2

The values to which the outputs are switched when the status Operational (OP) is left are specified here.

Index	Name	Meaning	Data type	Flags	Default
8011:0	DIG Safe state value		UINT8	RO	0x08 (8 <sub>dec</sub> )
8011:01	Output 9	0 <sub>bin</sub> : DIG Safe state value for output 9 = 0 1 <sub>bin</sub> : DIG Safe state value for output 9 = 1	boolean	RW	0x00 (0 <sub>dec</sub> )
8011:02	Output 10	0 <sub>bin</sub> : DIG Safe state value for output 10 = 0 1 <sub>bin</sub> : DIG Safe state value for output 10 = 1	boolean	RW	0x00 (0 <sub>dec</sub> )
8011:03	Output 11	0 <sub>bin</sub> : DIG Safe state value for output 11 = 0 1 <sub>bin</sub> : DIG Safe state value for output 11 = 1	boolean	RW	0x00 (0 <sub>dec</sub> )
8011:04	Output 12	0 <sub>bin</sub> : DIG Safe state value for output 12 = 0 1 <sub>bin</sub> : DIG Safe state value for output 12 = 1	boolean	RW	0x00 (0 <sub>dec</sub> )
8011:05	Output 13	0 <sub>bin</sub> : DIG Safe state value for output 13 = 0 1 <sub>bin</sub> : DIG Safe state value for output 13 = 1	boolean	RW	0x00 (0 <sub>dec</sub> )
8011:06	Output 14	0 <sub>bin</sub> : DIG Safe state value for output 14 = 0 1 <sub>bin</sub> : DIG Safe state value for output 14 = 1	boolean	RW	0x00 (0 <sub>dec</sub> )
8011:07	Output 15	0 <sub>bin</sub> : DIG Safe state value for output 15 = 0 1 <sub>bin</sub> : DIG Safe state value for output 15 = 1	boolean	RW	0x00 (0 <sub>dec</sub> )
8011:08	Output 16	0 <sub>bin</sub> : DIG Safe state value for output 16 = 0 1 <sub>bin</sub> : DIG Safe state value for output 16 = 1	boolean	RW	0x00 (0 <sub>dec</sub> )

### Objects for regular operation

The EP2xxx have no such objects.

### Additional objects

#### Standard objects (0x1000-0x1FFF)

The standard objects have the same meaning for all EtherCAT slaves.

### Index 1000 Device type

Index	Name	Meaning	Data type	Flags	Default
1000:0	Device type	Device type of the EtherCAT slave: The Lo-Word contains the CoE profile used (5001). The Hi-Word contains the module profile according to the modular device profile.	UINT32	RO	0x01181389 (18355081 <sub>dec</sub> )

**Index 1008 Device name**

Index	Name	Meaning	Data type	Flags	Default
1008:0	Device name	Device name of the EtherCAT slave	string	RO	EP2816-0008

**Index 1009 Hardware version**

Index	Name	Meaning	Data type	Flags	Default
1009:0	Hardware version	Hardware version of the EtherCAT slave	string	RO	02

**Index 100A Software Version**

Index	Name	Meaning	Data type	Flags	Default
100A:0	Software version	Firmware version of the EtherCAT slave	string	RO	05

**Index 1018 Identity**

Index	Name	Meaning	Data type	Flags	Default
1018:0	Identity	Information for identifying the slave	UINT8	RO	0x04 (4 <sub>dec</sub> )
1018:01	Vendor ID	Vendor ID of the EtherCAT slave	UINT32	RO	0x00000002 (2 <sub>dec</sub> )
1018:02	Product code	Product code of the EtherCAT slave	UINT32	RO	0x0B004052 (184565842 <sub>dec</sub> )
1018:03	Revision	Revision number of the EtherCAT slave; the low word (bit 0-15) indicates the special terminal number, the high word (bit 16-31) refers to the device description	UINT32	RO	0x00130008 (1245192 <sub>dec</sub> )
1018:04	Serial number	Serial number of the EtherCAT slave; the Low Byte (bit 0-7) of the Low Word contains the year of production, the High Byte (bit 8-15) of the Low Word contains the week of production, the High Word (bit 16-31) is 0	UINT32	RO	0x00000000 (0 <sub>dec</sub> )

**Index 10F0 Backup parameter handling**

Index	Name	Meaning	Data type	Flags	Default
10F0:0	Backup parameter handling	Information for standardized loading and saving of backup entries	UINT8	RO	0x01 (1 <sub>dec</sub> )
10F0:01	Checksum	Checksum across all backup entries of the EtherCAT slave	UINT32	RO	0x00000000 (0 <sub>dec</sub> )

**Index 1600 DIG RxPDO-Map Outputs Ch.1**

Index	Name	Meaning	Data type	Flags	Default
1600:0	DIG RxPDO-Map Outputs Ch.1	PDO Mapping RxPDO 1	UINT8	RO	0x09 (9 <sub>dec</sub> )
1600:01	SubIndex 001	1. PDO Mapping entry (object 0x7000 (DO Outputs Ch.1), entry 0x01 (Output 1))	UINT32	RO	0x7000:01, 1
1600:02	SubIndex 002	2. PDO Mapping entry (object 0x7000 (DO Outputs Ch.1), entry 0x02 (Output 2))	UINT32	RO	0x7000:02, 1
1600:03	SubIndex 003	3. PDO Mapping entry (object 0x7000 (DO Outputs Ch.1), entry 0x03 (Output 3))	UINT32	RO	0x7000:03, 1
1600:04	SubIndex 004	4. PDO Mapping entry (object 0x7000 (DO Outputs Ch.1), entry 0x04 (Output 4))	UINT32	RO	0x7000:04, 1
1600:05	SubIndex 005	5. PDO Mapping entry (object 0x7000 (DO Outputs Ch.1), entry 0x05 (Output 5))	UINT32	RO	0x7000:05, 1
1600:06	SubIndex 006	6. PDO Mapping entry (object 0x7000 (DO Outputs Ch.1), entry 0x06 (Output 6))	UINT32	RO	0x7000:06, 1
1600:07	SubIndex 007	7. PDO Mapping entry (object 0x7000 (DO Outputs Ch.1), entry 0x07 (Output 7))	UINT32	RO	0x7000:07, 1
1600:08	SubIndex 008	8. PDO Mapping entry (object 0x7000 (DO Outputs Ch.1), entry 0x08 (Output 8))	UINT32	RO	0x7000:08, 1
1600:09	SubIndex 009	9. PDO Mapping entry (8 bits align)	UINT32	RO	0x0000:00, 8

## Index 1601 DIG RxPDO-Map Outputs Ch.2

Index	Name	Meaning	Data type	Flags	Default
1601:0	DIG RxPDO-Map Outputs Ch.2	PDO Mapping RxPDO 2	UINT8	RO	0x09 (9 <sub>dec</sub> )
1601:01	SubIndex 001	1. PDO Mapping entry (object 0x7010 (DO Outputs Ch.2), entry 0x01 (Output 1))	UINT32	RO	0x7010:01, 1
1601:02	SubIndex 002	2. PDO Mapping entry (object 0x7010 (DO Outputs Ch.2), entry 0x02 (Output 2))	UINT32	RO	0x7010:02, 1
1601:03	SubIndex 003	3. PDO Mapping entry (object 0x7010 (DO Outputs Ch.2), entry 0x03 (Output 3))	UINT32	RO	0x7010:03, 1
1601:04	SubIndex 004	4. PDO Mapping entry (object 0x7010 (DO Outputs Ch.2), entry 0x04 (Output 4))	UINT32	RO	0x7010:04, 1
1601:05	SubIndex 005	5. PDO Mapping entry (object 0x7010 (DO Outputs Ch.2), entry 0x05 (Output 5))	UINT32	RO	0x7010:05, 1
1601:06	SubIndex 006	6. PDO Mapping entry (object 0x7010 (DO Outputs Ch.2), entry 0x06 (Output 6))	UINT32	RO	0x7010:06, 1
1601:07	SubIndex 007	7. PDO Mapping entry (object 0x7010 (DO Outputs Ch.2), entry 0x07 (Output 7))	UINT32	RO	0x7010:07, 1
1601:08	SubIndex 008	8. PDO Mapping entry (object 0x7010 (DO Outputs Ch.2), entry 0x08 (Output 8))	UINT32	RO	0x7010:08, 1
1601:09	SubIndex 009	9. PDO Mapping entry (8 bits align)	UINT32	RO	0x0000:00, 8

## Index 1602 DIG RxPDO-Map Outputs Device

Index	Name	Meaning	Data type	Flags	Default
1602:0	DIG RxPDO-Map Outputs Device	PDO Mapping RxPDO 3	UINT8	RO	0x03 (3 <sub>dec</sub> )
1602:01	SubIndex 001	1. PDO Mapping entry (object 0xF700 (DO Outputs), entry 0x01 (Set safe state))	UINT32	RO	0xF700:01, 1
1602:02	SubIndex 002	2. PDO Mapping entry (object 0xF700 (DO Outputs), entry 0x02 (Reset outputs))	UINT32	RO	0xF700:02, 1
1602:03	SubIndex 003	3. PDO Mapping entry (14 bits align)	UINT32	RO	0x0000:00, 14

## Index 1A00 DIG TxPDO-Map Diag Inputs Ch.1

Index	Name	Meaning	Data type	Flags	Default
1A00:0	DIG TxPDO-Map Diag Inputs Ch.1	PDO Mapping TxPDO 1	UINT8	RO	0x09 (9 <sub>dec</sub> )
1A00:01	SubIndex 001	1. PDO Mapping entry (object 0x6000 (DI Inputs Ch.1), entry 0x01 (Input 1))	UINT32	RO	0x6001:01, 1
1A00:02	SubIndex 002	2. PDO Mapping entry (object 0x6000 (DO Inputs Ch.1), entry 0x02 (Input 2))	UINT32	RO	0x6001:02, 1
1A00:03	SubIndex 003	3. PDO Mapping entry (object 0x6000 (DO Inputs Ch.1), entry 0x03 (Input 3))	UINT32	RO	0x6001:03, 1
1A00:04	SubIndex 004	4. PDO Mapping entry (object 0x6000 (DO Inputs Ch.1), entry 0x04 (Input 4))	UINT32	RO	0x6001:04, 1
1A00:05	SubIndex 005	5. PDO Mapping entry (object 0x6000 (DO Inputs Ch.1), entry 0x05 (Input 5))	UINT32	RO	0x6001:05, 1
1A00:06	SubIndex 006	6. PDO Mapping entry (object 0x6000 (DO Inputs Ch.1), entry 0x06 (Input 6))	UINT32	RO	0x6001:06, 1
1A00:07	SubIndex 007	7. PDO Mapping entry (object 0x6000 (DO Inputs Ch.1), entry 0x07 (Input 7))	UINT32	RO	0x6001:07, 1
1A00:08	SubIndex 008	8. PDO Mapping entry (object 0x6000 (DO Inputs Ch.1), entry 0x08 (Input 8))	UINT32	RO	0x6001:08, 1
1A00:09	SubIndex 009	9. PDO Mapping entry (5 bits align)	UINT32	RO	0x0000:00, 8

**Index 1A01 DIG TxPDO-Map Diag Inputs Ch.2**

Index	Name	Meaning	Data type	Flags	Default
1A01:0	DIG TxPDO-Map Diag Inputs Ch.2	PDO Mapping TxPDO 2	UINT8	RO	0x09 (9 <sub>dec</sub> )
1A01:01	SubIndex 001	1. PDO Mapping entry (object 0x6010 (DO Inputs Ch.2), entry 0x01 (Input 1))	UINT32	RO	0x6011:01, 1
1A01:02	SubIndex 002	2. PDO Mapping entry (object 0x6010 (DO Inputs Ch.2), entry 0x02 (Input 2))	UINT32	RO	0x6011:02, 1
1A01:03	SubIndex 003	3. PDO Mapping entry (object 0x6010 (DO Inputs Ch.2), entry 0x03 (Input 3))	UINT32	RO	0x6011:03, 1
1A01:04	SubIndex 004	4. PDO Mapping entry (object 0x6010 (DO Inputs Ch.2), entry 0x04 (Input 4))	UINT32	RO	0x6011:04, 1
1A01:05	SubIndex 005	5. PDO Mapping entry (object 0x6010 (DO Inputs Ch.2), entry 0x05 (Input 5))	UINT32	RO	0x6011:05, 1
1A01:06	SubIndex 006	6. PDO Mapping entry (object 0x6010 (DO Inputs Ch.2), entry 0x06 (Input 6))	UINT32	RO	0x6011:06, 1
1A01:07	SubIndex 007	7. PDO Mapping entry (object 0x6010 (DO Inputs Ch.2), entry 0x07 (Input 7))	UINT32	RO	0x6011:07, 1
1A01:08	SubIndex 008	8. PDO Mapping entry (object 0x6010 (DO Inputs Ch.2), entry 0x08 (Input 8))	UINT32	RO	0x6011:08, 1
1A01:09	SubIndex 009	9. PDO Mapping entry (5 bits align)	UINT32	RO	0x0000:00, 8

**Index 1A02 DIG TxPDO-Map Inputs Device**

Index	Name	Meaning	Data type	Flags	Default
1A02:0	DIG TxPDO-Map Inputs Device	PDO Mapping TxPDO 3	UINT8	RO	0x07 (7 <sub>dec</sub> )
1A02:01	SubIndex 001	1. PDO Mapping entry (object 0xF600 (DO Inputs), entry 0x01 (Safe state active))	UINT32	RO	0xF600:01, 1
1A02:02	SubIndex 002	2. PDO Mapping entry (object 0xF600 (DO Inputs), entry 0x02 (Error channel 1))	UINT32	RO	0xF600:02, 1
1A02:03	SubIndex 003	3. PDO Mapping entry (object 0xF600 (DO Inputs), entry 0x03 (Error channel 2))	UINT32	RO	0xF600:03, 1
1A02:04	SubIndex 004	4. PDO Mapping entry (10 bits align)	UINT32	RO	0x0000:00, 10
1A02:05	SubIndex 005	5. PDO Mapping entry (object 0xF600 (DO Inputs), entry 0x0E (Sync Error))	UINT32	RO	0x1C32:20, 1
1A02:06	SubIndex 006	6. PDO Mapping entry (1 bits align)	UINT32	RO	0x0000:00, 1
1A02:07	SubIndex 007	7. PDO Mapping entry (object 0x1800, entry 0x09)	UINT32	RO	0x1800:09, 1

**Index 1C00 Sync manager type**

Index	Name	Meaning	Data type	Flags	Default
1C00:0	Sync manager type	Using the Sync Managers	UINT8	RO	0x04 (4 <sub>dec</sub> )
1C00:01	SubIndex 001	Sync-Manager Type Channel 1: Mailbox Write	UINT8	RO	0x01 (1 <sub>dec</sub> )
1C00:02	SubIndex 002	Sync-Manager Type Channel 2: Mailbox Read	UINT8	RO	0x02 (2 <sub>dec</sub> )
1C00:03	SubIndex 003	Sync-Manager Type Channel 3: Process Data Write (Outputs)	UINT8	RO	0x03 (3 <sub>dec</sub> )
1C00:04	SubIndex 004	Sync-Manager Type Channel 4: Process Data Read (Inputs)	UINT8	RO	0x04 (4 <sub>dec</sub> )

**Index 1C12 RxPDO assign**

Index	Name	Meaning	Data type	Flags	Default
1C12:0	RxPDO assign	PDO Assign Outputs	UINT8	RW	0x03 (3 <sub>dec</sub> )
1C12:01	Subindex 001	1. allocated RxPDO (contains the index of the associated RxPDO mapping object)	UINT16	RW	0x1600 (5632 <sub>dec</sub> )
1C12:02	Subindex 002	2. allocated RxPDO (contains the index of the associated RxPDO mapping object)	UINT16	RW	0x1601 (5633 <sub>dec</sub> )
1C12:03	Subindex 003	3. allocated RxPDO (contains the index of the associated RxPDO mapping object)	UINT16	RW	0x1602 (5634 <sub>dec</sub> )

## Index 1C13 TxPDO assign

Index	Name	Meaning	Data type	Flags	Default
1C13:0	TxPDO assign	PDO Assign Inputs	UINT8	RW	0x03 (3 <sub>dec</sub> )
1C13:01	Subindex 001	1. allocated TxPDO (contains the index of the associated TxPDO mapping object)	UINT16	RW	0x1A00 (6656 <sub>dec</sub> )
1C13:02	Subindex 002	2. allocated TxPDO (contains the index of the associated TxPDO mapping object)	UINT16	RW	0x1A01 (6657 <sub>dec</sub> )
1C13:03	Subindex 003	3. allocated TxPDO (contains the index of the associated TxPDO mapping object)	UINT16	RW	0x1A02 (6658 <sub>dec</sub> )

## Index 1C32 SM output parameter

Index	Name	Meaning	Data type	Flags	Default
1C32:0	SM output parameter	Synchronization parameters for the outputs	UINT8	RO	0x20 (32 <sub>dec</sub> )
1C32:01	Sync mode	Current synchronization mode: <ul style="list-style-type: none"> <li>0: Free Run</li> <li>1: Synchron with SM 2 Event</li> <li>2: DC-Mode - Synchron with SYNC0 Event</li> <li>3: DC-Mode - Synchron with SYNC1 Event</li> </ul>	UINT16	RW	0x0001 (1 <sub>dec</sub> )
1C32:02	Cycle time	Cycle time (in ns): <ul style="list-style-type: none"> <li>Free Run: Cycle time of the local timer</li> <li>Synchron with SM 2 Event: Master cycle time</li> <li>DC mode: SYNC0/SYNC1 Cycle Time</li> </ul>	UINT32	RW	0x000F4240 (1000000 <sub>dec</sub> )
1C32:03	Shift time	Time between SYNC0 event and output of the outputs (in ns, DC mode only)	UINT32	RO	0x00020F58 (135000 <sub>dec</sub> )
1C32:04	Sync modes supported	Supported synchronization modes: <ul style="list-style-type: none"> <li>Bit 0 = 1: free run is supported</li> <li>Bit 1 = 1: Synchron with SM 2 Event is supported</li> <li>Bit 2-3 = 01: DC mode is supported</li> <li>Bit 4-5 = 10: Output Shift with SYNC1 event (only DC mode)</li> <li>Bit 14 = 1: dynamic times (measurement through writing of <a href="#">1C32:08</a> [<a href="#">▶ 158</a>])</li> </ul>	UINT16	RO	0xC007 (49159 <sub>dec</sub> )
1C32:05	Minimum cycle time	Minimum cycle time (in ns)	UINT32	RO	0x00030D40 (200000 <sub>dec</sub> )
1C32:06	Calc and copy time	Minimum time between SYNC0 and SYNC1 event (in ns, DC mode only)	UINT32	RO	0x00000000 (0 <sub>dec</sub> )
1C32:07	Minimum delay time		UINT32	RO	0x00020F58 (135000 <sub>dec</sub> )
1C32:08	Command	<ul style="list-style-type: none"> <li>0: Measurement of the local cycle time is stopped</li> <li>1: Measurement of the local cycle time is started</li> </ul> <p>The entries <a href="#">1C32:03</a> [<a href="#">▶ 158</a>], <a href="#">1C32:05</a> [<a href="#">▶ 158</a>], <a href="#">1C32:06</a> [<a href="#">▶ 158</a>], <a href="#">1C32:09</a> [<a href="#">▶ 158</a>], <a href="#">1C33:03</a> [<a href="#">▶ 159</a>], <a href="#">1C33:06</a> [<a href="#">▶ 158</a>], <a href="#">1C33:09</a> [<a href="#">▶ 159</a>] are updated with the maximum measured values. For a subsequent measurement the measured values are reset</p>	UINT16	RW	0x0000 (0 <sub>dec</sub> )
1C32:09	Maximum Delay time	Time between SYNC1 event and output of the outputs (in ns, DC mode only)	UINT32	RO	0x00020F58 (135000 <sub>dec</sub> )
1C32:0B	SM event missed counter	Number of missed SM events in OPERATIONAL (DC mode only)	UINT16	RO	0x0000 (0 <sub>dec</sub> )
1C32:0C	Cycle exceeded counter	Number of occasions the cycle time was exceeded in OPERATIONAL (cycle was not completed in time or the next cycle began too early)	UINT16	RO	0x0000 (0 <sub>dec</sub> )
1C32:0D	Shift too short counter	Number of occasions that the interval between SYNC0 and SYNC1 event was too short (DC mode only)	UINT16	RO	0x0000 (0 <sub>dec</sub> )
1C32:20	Sync error	The synchronization was not correct in the last cycle (outputs were output too late; DC mode only)	boolean	RO	0x00 (0 <sub>dec</sub> )

**Index 1C33 SM input parameter**

Index	Name	Meaning	Data type	Flags	Default
1C33:0	SM input parameter	Synchronization parameters for the inputs	UINT8	RO	0x20 (32 <sub>dec</sub> )
1C33:01	Sync mode	Current synchronization mode: <ul style="list-style-type: none"> <li>0: Free Run</li> <li>1: Synchron with SM 3 Event (no outputs available)</li> <li>2: DC - Synchron with SYNC0 Event</li> <li>3: DC - Synchron with SYNC1 Event</li> <li>34: Synchron with SM 2 Event (outputs available)</li> </ul>	UINT16	RW	0x0022 (34 <sub>dec</sub> )
1C33:02	Cycle time	as <a href="#">1C32:02</a> [ <a href="#">▶ 158</a> ]	UINT32	RW	0x000F4240 (1000000 <sub>dec</sub> )
1C33:03	Shift time	Time between SYNC0 event and reading of the inputs (in ns, only DC mode)	UINT32	RO	0x00000000 (0 <sub>dec</sub> )
1C33:04	Sync modes supported	Supported synchronization modes: <ul style="list-style-type: none"> <li>Bit 0: free run is supported</li> <li>Bit 1: Synchron with SM 2 Event is supported (outputs available)</li> <li>Bit 1: Synchron with SM 3 Event is supported (no outputs available)</li> <li>Bit 2-3 = 01: DC mode is supported</li> <li>Bit 4-5 = 01: Input Shift through local event (outputs available)</li> <li>Bit 4-5 = 10: Input Shift with SYNC1 event (no outputs available)</li> <li>Bit 14 = 1: dynamic times (measurement through writing of <a href="#">1C32:08</a> [<a href="#">▶ 158</a>] or <a href="#">1C33:08</a> [<a href="#">▶ 159</a>])</li> </ul>	UINT16	RO	0xC007 (49159 <sub>dec</sub> )
1C33:05	Minimum cycle time	as <a href="#">1C32:05</a> [ <a href="#">▶ 158</a> ]	UINT32	RO	0x00030D40 (200000 <sub>dec</sub> )
1C33:06	Calc and copy time	Time between reading of the inputs and availability of the inputs for the master (in ns, only DC mode)	UINT32	RO	0x00000000 (0 <sub>dec</sub> )
1C33:07	Minimum delay time		UINT32	RO	0x00000000 (0 <sub>dec</sub> )
1C33:08	Command	as <a href="#">1C32:08</a> [ <a href="#">▶ 158</a> ]	UINT16	RW	0x0000 (0 <sub>dec</sub> )
1C33:09	Maximum Delay time	Time between SYNC1 event and reading of the inputs (in ns, only DC mode)	UINT32	RO	0x00000000 (0 <sub>dec</sub> )
1C33:0B	SM event missed counter	as <a href="#">1C32:11</a> [ <a href="#">▶ 158</a> ]	UINT16	RO	0x0000 (0 <sub>dec</sub> )
1C33:0C	Cycle exceeded counter	as <a href="#">1C32:12</a> [ <a href="#">▶ 158</a> ]	UINT16	RO	0x0000 (0 <sub>dec</sub> )
1C33:0D	Shift too short counter	as <a href="#">1C32:13</a> [ <a href="#">▶ 158</a> ]	UINT16	RO	0x0000 (0 <sub>dec</sub> )
1C33:20	Sync error	as <a href="#">1C32:32</a> [ <a href="#">▶ 158</a> ]	boolean	RO	0x00 (0 <sub>dec</sub> )

**Profile-specific objects (0x6000-0xFFFF)**

The profile-specific objects have the same meaning for all EtherCAT slaves that support the profile 5001.

**Index 6001 DIG Diag Inputs Ch.1**

Index	Name	Meaning	Data type	Flags	Default
6001:0	DIG Diag Inputs Ch.1		UINT8	RO	0x08 (8 <sub>dec</sub> )
6001:01	Diag Input 1		boolean	RO	0x00 (0 <sub>dec</sub> )
6001:02	Diag Input 2		boolean	RO	0x00 (0 <sub>dec</sub> )
6001:03	Diag Input 3		boolean	RO	0x00 (0 <sub>dec</sub> )
6001:04	Diag Input 4		boolean	RO	0x00 (0 <sub>dec</sub> )
6001:05	Diag Input 5		boolean	RO	0x00 (0 <sub>dec</sub> )
6001:06	Diag Input 6		boolean	RO	0x00 (0 <sub>dec</sub> )
6001:07	Diag Input 7		boolean	RO	0x00 (0 <sub>dec</sub> )
6001:08	Diag Input 8		boolean	RO	0x00 (0 <sub>dec</sub> )

**Index 6011 DIG Diag Inputs Ch.2**

Index	Name	Meaning	Data type	Flags	Default
6011:0	DIG Diag Inputs Ch.2		UINT8	RO	0x08 (8 <sub>dec</sub> )
6011:01	Diag Input 1		boolean	RO	0x00 (0 <sub>dec</sub> )
6011:02	Diag Input 2		boolean	RO	0x00 (0 <sub>dec</sub> )
6011:03	Diag Input 3		boolean	RO	0x00 (0 <sub>dec</sub> )
6011:04	Diag Input 4		boolean	RO	0x00 (0 <sub>dec</sub> )
6011:05	Diag Input 5		boolean	RO	0x00 (0 <sub>dec</sub> )
6011:06	Diag Input 6		boolean	RO	0x00 (0 <sub>dec</sub> )
6011:07	Diag Input 7		boolean	RO	0x00 (0 <sub>dec</sub> )
6011:08	Diag Input 8		boolean	RO	0x00 (0 <sub>dec</sub> )

**Index 7000 DIG Outputs Ch.1**

Index	Name	Meaning	Data type	Flags	Default
7000:0	DIG Outputs Ch.1		UINT8	RO	0x08 (8 <sub>dec</sub> )
7000:01	Output 1		boolean	RO	0x00 (0 <sub>dec</sub> )
7000:02	Output 2		boolean	RO	0x00 (0 <sub>dec</sub> )
7000:03	Output 3		boolean	RO	0x00 (0 <sub>dec</sub> )
7000:04	Output 4		boolean	RO	0x00 (0 <sub>dec</sub> )
7000:05	Output 5		boolean	RO	0x00 (0 <sub>dec</sub> )
7000:06	Output 6		boolean	RO	0x00 (0 <sub>dec</sub> )
7000:07	Output 7		boolean	RO	0x00 (0 <sub>dec</sub> )
7000:08	Output 8		boolean	RO	0x00 (0 <sub>dec</sub> )

**Index 7010 DIG Outputs Ch.2**

Index	Name	Meaning	Data type	Flags	Default
7010:0	DIG Outputs Ch.2		UINT8	RO	0x08 (8 <sub>dec</sub> )
7010:01	Output 1		boolean	RO	0x00 (0 <sub>dec</sub> )
7010:02	Output 2		boolean	RO	0x00 (0 <sub>dec</sub> )
7010:03	Output 3		boolean	RO	0x00 (0 <sub>dec</sub> )
7010:04	Output 4		boolean	RO	0x00 (0 <sub>dec</sub> )
7010:05	Output 5		boolean	RO	0x00 (0 <sub>dec</sub> )
7010:06	Output 6		boolean	RO	0x00 (0 <sub>dec</sub> )
7010:07	Output 7		boolean	RO	0x00 (0 <sub>dec</sub> )
7010:08	Output 8		boolean	RO	0x00 (0 <sub>dec</sub> )

**Index F000 Modular device profile**

Index	Name	Meaning	Data type	Flags	Default
F000:0	Modular device profile	General information for the modular device profile	UINT8	RO	0x02 (2 <sub>dec</sub> )
F000:01	Module index distance	Index distance of the objects of the individual channels	UINT16	RO	0x0010 (16 <sub>dec</sub> )
F000:02	Maximum number of modules	Number of channels	UINT16	RO	0x0002 (2 <sub>dec</sub> )

**Index F008 Code word**

Index	Name	Meaning	Data type	Flags	Default
F008:0	Code word		UINT32	RW	0x00000000 (0 <sub>dec</sub> )



**Index F010 Module list**

Index	Name	Meaning	Data type	Flags	Default
F010:0	Module list		UINT8	RW	0x02 (2 <sub>dec</sub> )
F010:01	SubIndex 001		UINT32	RW	0x00000118 (280 <sub>dec</sub> )
F010:02	SubIndex 002		UINT32	RW	0x00000118 (280 <sub>dec</sub> )

**Index F600 DIG Inputs**

Index	Name	Meaning	Data type	Flags	Default
F600:0	DIG Inputs		UINT8	RO	0x10 (16 <sub>dec</sub> )
F600:01	Safe state active		boolean	RO	0x00 (0 <sub>dec</sub> )
F600:02	Error channel 1		boolean	RO	0x00 (0 <sub>dec</sub> )
F600:03	Error channel 2		boolean	RO	0x00 (0 <sub>dec</sub> )
F600:0E	Sync error		boolean	RO	0x00 (0 <sub>dec</sub> )
F600:10	TxPDO Toggle		boolean	RO	0x00 (0 <sub>dec</sub> )

**Index F700 DIG Outputs**

Index	Name	Meaning	Data type	Flags	Default
F700:0	DIG Outputs		UINT8	RO	0x02 (2 <sub>dec</sub> )
F700:01	Set safe state		boolean	RO	0x00 (0 <sub>dec</sub> )
F700:02	Reset outputs		boolean	RO	0x00 (0 <sub>dec</sub> )

**Index F800 DIG Settings**

Index	Name	Meaning	Data type	Flags	Default
F800:0	DIG Settings		UINT8	RO	0x11 (17 <sub>dec</sub> )
F800:01	Disable shut off		boolean	RW	0x00 (0 <sub>dec</sub> )
F800:11	Switch off time		UINT16	RW	0x03E8 (1000 <sub>dec</sub> )

## 7.3 EP2817-0008

### 7.3.1 Object overview

#### ● EtherCAT XML Device Description



The display matches that of the CoE objects from the EtherCAT XML Device Description. We recommend downloading the latest XML file from the download area of the Beckhoff website and installing it according to the installation instructions.

Index	Name	Flags	Default value
1000 [▶ 171]	Device type	RO	0x01181389 (18355081 <sub>dec</sub> )
1008 [▶ 171]	Device name	RO	EP2817-0008
1009 [▶ 171]	Hardware version	RO	
100A [▶ 171]	Software version	RO	00
1011:0 [▶ 168]	<b>Subindex</b> Restore default parameters	RO	0x01 (1 <sub>dec</sub> )
	1011:01 SubIndex 001	RW	0x00000000 (0 <sub>dec</sub> )
1018:0 [▶ 172]	<b>Subindex</b> Identity	RO	0x04 (4 <sub>dec</sub> )
	1018:01 Vendor ID	RO	0x00000002 (2 <sub>dec</sub> )
	1018:02 Product code	RO	0x0B014052 (184631378 <sub>dec</sub> )
	1018:03 Revision	RO	0x00000000 (0 <sub>dec</sub> )
	1018:04 Serial number	RO	0x00000000 (0 <sub>dec</sub> )
10F0:0 [▶ 172]	<b>Subindex</b> Backup parameter handling	RO	0x01 (1 <sub>dec</sub> )
	10F0:01 Checksum	RO	0x00000000 (0 <sub>dec</sub> )
1600:0 [▶ 172]	<b>Subindex</b> DIG RxPDO-Map OutputsCh.1	RO	0x09 (9 <sub>dec</sub> )
	1600:01 SubIndex 001	RO	0x7000:01, 1
	1600:02 SubIndex 002	RO	0x7000:02, 1
	1600:03 SubIndex 003	RO	0x7000:03, 1
	1600:04 SubIndex 004	RO	0x7000:04, 1
	1600:05 SubIndex 005	RO	0x7000:05, 1
	1600:06 SubIndex 006	RO	0x7000:06, 1
	1600:07 SubIndex 007	RO	0x7000:07, 1
	1600:08 SubIndex 008	RO	0x7000:08, 1
	1600:09 SubIndex 009	RO	0x0000:00, 8
1601:0 [▶ 173]	<b>Subindex</b> DIG RxPDO-Map OutputsCh.2	RO	0x09 (9 <sub>dec</sub> )
	1601:01 SubIndex 001	RO	0x7010:01, 1
	1601:02 SubIndex 002	RO	0x7010:02, 1
	1601:03 SubIndex 003	RO	0x7010:03, 1
	1601:04 SubIndex 004	RO	0x7010:04, 1
	1601:05 SubIndex 005	RO	0x7010:05, 1
	1601:06 SubIndex 006	RO	0x7010:06, 1
	1601:07 SubIndex 007	RO	0x7010:07, 1
	1601:08 SubIndex 008	RO	0x7010:08, 1
	1601:09 SubIndex 009	RO	0x0000:00, 8
1602:0 [▶ 173]	<b>Subindex</b> DIG RxPDO-Map OutputsCh.3	RO	0x09 (9 <sub>dec</sub> )
	1602:01 SubIndex 001	RO	0x7020:01, 1
	1602:02 SubIndex 002	RO	0x7020:02, 1
	1602:03 SubIndex 003	RO	0x7020:03, 1
	1602:04 SubIndex 004	RO	0x7020:04, 1
	1602:05 SubIndex 005	RO	0x7020:05, 1
	1602:06 SubIndex 006	RO	0x7020:06, 1
	1602:07 SubIndex 007	RO	0x7020:07, 1
	1602:08 SubIndex 008	RO	0x7020:08, 1
	1602:09 SubIndex 009	RO	0x0000:00, 8

Index		Name	Flags	Default value
1603:0 [▶ 173]	<b>Subindex</b>	DIG RxPDO-Map Outputs Device	RO	0x03 (3 <sub>dec</sub> )
	1603:01	SubIndex 001	RO	0xF700:01, 1
	1603:02	SubIndex 002	RO	0xF700:02, 1
	1603:03	SubIndex 003	RO	0x0000:00, 14
1A00:0 [▶ 174]	<b>Subindex</b>	DIG TxPDO-Map Diag Inputs Ch.1	RO	0x09 (9 <sub>dec</sub> )
	1A00:01	SubIndex 001	RO	0x6001:01, 1
	1A00:02	SubIndex 002	RO	0x6001:02, 1
	1A00:03	SubIndex 003	RO	0x6001:03, 1
	1A00:04	SubIndex 004	RO	0x6001:04, 1
	1A00:05	SubIndex 005	RO	0x6001:05, 1
	1A00:06	SubIndex 006	RO	0x6001:06, 1
	1A00:07	SubIndex 007	RO	0x6001:07, 1
	1A00:08	SubIndex 008	RO	0x6001:08, 1
	1A00:09	SubIndex 009	RO	0x0000:00, 8
1A01:0 [▶ 174]	<b>Subindex</b>	DIG TxPDO-Map Diag Inputs Ch.2	RO	0x09 (9 <sub>dec</sub> )
	1A01:01	SubIndex 001	RO	0x6011:01, 1
	1A01:02	SubIndex 002	RO	0x6011:02, 1
	1A01:03	SubIndex 003	RO	0x6011:03, 1
	1A01:04	SubIndex 004	RO	0x6011:04, 1
	1A01:05	SubIndex 005	RO	0x6011:05, 1
	1A01:06	SubIndex 006	RO	0x6011:06, 1
	1A01:07	SubIndex 007	RO	0x6011:07, 1
	1A01:08	SubIndex 008	RO	0x6011:08, 1
	1A01:09	SubIndex 009	RO	0x0000:00, 8
1A02:0 [▶ 175]	<b>Subindex</b>	DIG TxPDO-Map Diag Inputs Ch.3	RO	0x09 (9 <sub>dec</sub> )
	1A02:01	SubIndex 001	RO	0x6021:01, 1
	1A02:02	SubIndex 002	RO	0x6021:02, 1
	1A02:03	SubIndex 003	RO	0x6021:03, 1
	1A02:04	SubIndex 004	RO	0x6021:04, 1
	1A02:05	SubIndex 005	RO	0x6021:05, 1
	1A02:06	SubIndex 006	RO	0x6021:06, 1
	1A02:07	SubIndex 007	RO	0x6021:07, 1
	1A02:08	SubIndex 008	RO	0x6021:08, 1
	1A02:09	SubIndex 009	RO	0x0000:00, 8
1A03:0 [▶ 175]	<b>Subindex</b>	DIG TxPDO-Map Inputs Device	RO	0x0A (10 <sub>dec</sub> )
	1A03:01	SubIndex 001	RO	0xF600:01, 1
	1A03:02	SubIndex 002	RO	0xF600:02, 1
	1A03:03	SubIndex 003	RO	0xF600:03, 1
	1A03:04	SubIndex 004	RO	0xF600:04, 1
	1A03:05	SubIndex 005	RO	0xF600:05, 1
	1A03:06	SubIndex 006	RO	0xF600:06, 1
	1A03:07	SubIndex 007	RO	0x0000:00, 7
	1A03:08	SubIndex 008	RO	0xF600:0E, 1
	1A03:09	SubIndex 009	RO	0x0000:00, 1
	1A03:0A	SubIndex 010	RO	0xF600:10, 1
1C00:0 [▶ 175]	<b>Subindex</b>	Sync manager type	RO	0x04 (4 <sub>dec</sub> )
	1C00:01	SubIndex 001	RO	0x01 (1 <sub>dec</sub> )
	1C00:02	SubIndex 002	RO	0x02 (2 <sub>dec</sub> )
	1C00:03	SubIndex 003	RO	0x03 (3 <sub>dec</sub> )
	1C00:04	SubIndex 004	RO	0x04 (4 <sub>dec</sub> )
1C12:0 [▶ 176]	<b>Subindex</b>	RxPDO assign	RW	0x04 (4 <sub>dec</sub> )
	1C12:01	SubIndex 001	RW	0x1600 (5632 <sub>dec</sub> )
	1C12:02	SubIndex 002	RW	0x1601 (5633 <sub>dec</sub> )
	1C12:03	SubIndex 003	RW	0x1602 (5634 <sub>dec</sub> )
	1C12:04	SubIndex 004	RW	0x1603 (5635 <sub>dec</sub> )

Index		Name	Flags	Default value
1C13:0 [▶ 176]	<b>Subindex</b>	TxPDO assign	RW	0x04 (4 <sub>dec</sub> )
	1C13:01	SubIndex 001	RW	0x1A00 (6656 <sub>dec</sub> )
	1C13:02	SubIndex 002	RW	0x1A01 (6657 <sub>dec</sub> )
	1C13:03	SubIndex 003	RW	0x1A02 (6658 <sub>dec</sub> )
	1C13:04	SubIndex 004	RW	0x1A03 (6659 <sub>dec</sub> )
1C32:0 [▶ 177]	<b>Subindex</b>	SM output parameter	RO	0x20 (32 <sub>dec</sub> )
	1C32:01	Sync mode	RW	0x0001 (1 <sub>dec</sub> )
	1C32:02	Cycle time	RW	0x003D0900 (4000000 <sub>dec</sub> )
	1C32:03	Shift time	RO	0x00000000 (0 <sub>dec</sub> )
	1C32:04	Sync modes supported	RO	0x000A (10 <sub>dec</sub> )
	1C32:05	Minimum cycle time	RO	0x000493E0 (300000 <sub>dec</sub> )
	1C32:06	Calc and copy time	RO	0x00000000 (0 <sub>dec</sub> )
	1C32:07	Minimum delay time	RO	0x00000000 (0 <sub>dec</sub> )
	1C32:08	Command	RW	0x0000 (0 <sub>dec</sub> )
	1C32:09	Maximum delay time	RO	0x00000000 (0 <sub>dec</sub> )
	1C32:0B	SM event missed counter	RO	0x0000 (0 <sub>dec</sub> )
	1C32:0C	Cycle exceeded counter	RO	0x0000 (0 <sub>dec</sub> )
	1C32:0D	Shift too short counter	RO	0x0000 (0 <sub>dec</sub> )
	1C32:20	Sync error	RO	0x00 (0 <sub>dec</sub> )
1C33:0 [▶ 178]	<b>Subindex</b>	SM input parameter	RO	0x20 (32 <sub>dec</sub> )
	1C33:01	Sync mode	RW	0x0022 (34 <sub>dec</sub> )
	1C33:02	Cycle time	RW	0x003D0900 (4000000 <sub>dec</sub> )
	1C33:03	Shift time	RO	0x00000000 (0 <sub>dec</sub> )
	1C33:04	Sync modes supported	RO	0x000A (10 <sub>dec</sub> )
	1C33:05	Minimum cycle time	RO	0x000493E0 (300000 <sub>dec</sub> )
	1C33:06	Calc and copy time	RO	0x00000000 (0 <sub>dec</sub> )
	1C33:07	Minimum delay time	RO	0x00000000 (0 <sub>dec</sub> )
	1C33:08	Command	RW	0x0000 (0 <sub>dec</sub> )
	1C33:09	Maximum delay time	RO	0x00000000 (0 <sub>dec</sub> )
	1C33:0B	SM event missed counter	RO	0x0000 (0 <sub>dec</sub> )
	1C33:0C	Cycle exceeded counter	RO	0x0000 (0 <sub>dec</sub> )
	1C33:0D	Shift too short counter	RO	0x0000 (0 <sub>dec</sub> )
	1C33:20	Sync error	RO	0x00 (0 <sub>dec</sub> )
6001:0 [▶ 179]	<b>Subindex</b>	DIG Diag Inputs Ch.1	RO	0x08 (8 <sub>dec</sub> )
	6001:01	Diag Input 1	RO	0x00 (0 <sub>dec</sub> )
	6001:02	Diag Input 2	RO	0x00 (0 <sub>dec</sub> )
	6001:03	Diag Input 3	RO	0x00 (0 <sub>dec</sub> )
	6001:04	Diag Input 4	RO	0x00 (0 <sub>dec</sub> )
	6001:05	Diag Input 5	RO	0x00 (0 <sub>dec</sub> )
	6001:06	Diag Input 6	RO	0x00 (0 <sub>dec</sub> )
	6001:07	Diag Input 7	RO	0x00 (0 <sub>dec</sub> )
	6001:08	Diag Input 8	RO	0x00 (0 <sub>dec</sub> )
6011:0 [▶ 179]	<b>Subindex</b>	DIG Diag Inputs Ch.2	RO	0x08 (8 <sub>dec</sub> )
	6011:01	Diag Input 1	RO	0x00 (0 <sub>dec</sub> )
	6011:02	Diag Input 2	RO	0x00 (0 <sub>dec</sub> )
	6011:03	Diag Input 3	RO	0x00 (0 <sub>dec</sub> )
	6011:04	Diag Input 4	RO	0x00 (0 <sub>dec</sub> )
	6011:05	Diag Input 5	RO	0x00 (0 <sub>dec</sub> )
	6011:06	Diag Input 6	RO	0x00 (0 <sub>dec</sub> )
	6011:07	Diag Input 7	RO	0x00 (0 <sub>dec</sub> )
	6011:08	Diag Input 8	RO	0x00 (0 <sub>dec</sub> )

Index		Name	Flags	Default value
6021:0 <a href="#">▶ 179</a>	<b>Subindex</b>	DIG Diag Inputs Ch.3	RO	0x08 (8 <sub>dec</sub> )
	6021:01	Diag Input 1	RO	0x00 (0 <sub>dec</sub> )
	6021:02	Diag Input 2	RO	0x00 (0 <sub>dec</sub> )
	6021:03	Diag Input 3	RO	0x00 (0 <sub>dec</sub> )
	6021:04	Diag Input 4	RO	0x00 (0 <sub>dec</sub> )
	6021:05	Diag Input 5	RO	0x00 (0 <sub>dec</sub> )
	6021:06	Diag Input 6	RO	0x00 (0 <sub>dec</sub> )
	6021:07	Diag Input 7	RO	0x00 (0 <sub>dec</sub> )
	6021:08	Diag Input 8	RO	0x00 (0 <sub>dec</sub> )
7000:0 <a href="#">▶ 179</a>	<b>Subindex</b>	DIG Outputs Ch. 1	RO	0x08 (8 <sub>dec</sub> )
	7000:01	Output 1	RO	0x00 (0 <sub>dec</sub> )
	7000:02	Output 2	RO	0x00 (0 <sub>dec</sub> )
	7000:03	Output 3	RO	0x00 (0 <sub>dec</sub> )
	7000:04	Output 4	RO	0x00 (0 <sub>dec</sub> )
	7000:05	Output 5	RO	0x00 (0 <sub>dec</sub> )
	7000:06	Output 6	RO	0x00 (0 <sub>dec</sub> )
	7000:07	Output 7	RO	0x00 (0 <sub>dec</sub> )
	7000:08	Output 8	RO	0x00 (0 <sub>dec</sub> )
7010:0 <a href="#">▶ 180</a>	<b>Subindex</b>	DIG Outputs Ch.2	RO	0x08 (8 <sub>dec</sub> )
	7010:01	Output 1	RO	0x00 (0 <sub>dec</sub> )
	7010:02	Output 2	RO	0x00 (0 <sub>dec</sub> )
	7010:03	Output 3	RO	0x00 (0 <sub>dec</sub> )
	7010:04	Output 4	RO	0x00 (0 <sub>dec</sub> )
	7010:05	Output 5	RO	0x00 (0 <sub>dec</sub> )
	7010:06	Output 6	RO	0x00 (0 <sub>dec</sub> )
	7010:07	Output 7	RO	0x00 (0 <sub>dec</sub> )
	7010:08	Output 8	RO	0x00 (0 <sub>dec</sub> )
7020:0 <a href="#">▶ 180</a>	<b>Subindex</b>	DIG Outputs Ch.3	RO	0x08 (8 <sub>dec</sub> )
	7020:01	Output 1	RO	0x00 (0 <sub>dec</sub> )
	7020:02	Output 2	RO	0x00 (0 <sub>dec</sub> )
	7020:03	Output 3	RO	0x00 (0 <sub>dec</sub> )
	7020:04	Output 4	RO	0x00 (0 <sub>dec</sub> )
	7020:05	Output 5	RO	0x00 (0 <sub>dec</sub> )
	7020:06	Output 6	RO	0x00 (0 <sub>dec</sub> )
	7020:07	Output 7	RO	0x00 (0 <sub>dec</sub> )
	7020:08	Output 8	RO	0x00 (0 <sub>dec</sub> )
8000:0 <a href="#">▶ 168</a>	<b>Subindex</b>	DIG Safe state active Ch.1	RW	0x08 (8 <sub>dec</sub> )
	8000:01	Output 1	RW	0x01 (1 <sub>dec</sub> )
	8000:02	Output 2	RW	0x01 (1 <sub>dec</sub> )
	8000:03	Output 3	RW	0x01 (1 <sub>dec</sub> )
	8000:04	Output 4	RW	0x01 (1 <sub>dec</sub> )
	8000:05	Output 5	RW	0x01 (1 <sub>dec</sub> )
	8000:06	Output 6	RW	0x01 (1 <sub>dec</sub> )
	8000:07	Output 7	RW	0x01 (1 <sub>dec</sub> )
	8000:08	Output 8	RW	0x01 (1 <sub>dec</sub> )
8001:0 <a href="#">▶ 169</a>	<b>Subindex</b>	DIG Safe state value Ch.1	RW	0x08 (8 <sub>dec</sub> )
	8001:01	Output 1	RW	0x00 (0 <sub>dec</sub> )
	8001:02	Output 2	RW	0x00 (0 <sub>dec</sub> )
	8001:03	Output 3	RW	0x00 (0 <sub>dec</sub> )
	8001:04	Output 4	RW	0x00 (0 <sub>dec</sub> )
	8001:05	Output 5	RW	0x00 (0 <sub>dec</sub> )
	8001:06	Output 6	RW	0x00 (0 <sub>dec</sub> )
	8001:07	Output 7	RW	0x00 (0 <sub>dec</sub> )
	8001:08	Output 8	RW	0x00 (0 <sub>dec</sub> )

Index		Name	Flags	Default value
8010:0 [▶ 169]	<b>Subindex</b>	DIG Safe state active Ch.2	RW	0x08 (8 <sub>dec</sub> )
	8010:01	Output 1	RW	0x01 (1 <sub>dec</sub> )
	8010:02	Output 2	RW	0x01 (1 <sub>dec</sub> )
	8010:03	Output 3	RW	0x01 (1 <sub>dec</sub> )
	8010:04	Output 4	RW	0x01 (1 <sub>dec</sub> )
	8010:05	Output 5	RW	0x01 (1 <sub>dec</sub> )
	8010:06	Output 6	RW	0x01 (1 <sub>dec</sub> )
	8010:07	Output 7	RW	0x01 (1 <sub>dec</sub> )
	8010:08	Output 8	RW	0x01 (1 <sub>dec</sub> )
8011:0 [▶ 169]	<b>Subindex</b>	DIG Safe state value Ch.2	RW	0x08 (8 <sub>dec</sub> )
	8011:01	Output 1	RW	0x00 (0 <sub>dec</sub> )
	8011:02	Output 2	RW	0x00 (0 <sub>dec</sub> )
	8011:03	Output 3	RW	0x00 (0 <sub>dec</sub> )
	8011:04	Output 4	RW	0x00 (0 <sub>dec</sub> )
	8011:05	Output 5	RW	0x00 (0 <sub>dec</sub> )
	8011:06	Output 6	RW	0x00 (0 <sub>dec</sub> )
	8011:07	Output 7	RW	0x00 (0 <sub>dec</sub> )
	8011:08	Output 8	RW	0x00 (0 <sub>dec</sub> )
8020:0 [▶ 170]	<b>Subindex</b>	DIG Safe state active Ch.3	RW	0x08 (8 <sub>dec</sub> )
	8020:01	Output 1	RW	0x01 (1 <sub>dec</sub> )
	8020:02	Output 2	RW	0x01 (1 <sub>dec</sub> )
	8020:03	Output 3	RW	0x01 (1 <sub>dec</sub> )
	8020:04	Output 4	RW	0x01 (1 <sub>dec</sub> )
	8020:05	Output 5	RW	0x01 (1 <sub>dec</sub> )
	8020:06	Output 6	RW	0x01 (1 <sub>dec</sub> )
	8020:07	Output 7	RW	0x01 (1 <sub>dec</sub> )
	8020:08	Output 8	RW	0x01 (1 <sub>dec</sub> )
8021:0 [▶ 170]	<b>Subindex</b>	DIG Safe state value Ch.3	RW	0x08 (8 <sub>dec</sub> )
	8021:01	Output 1	RW	0x00 (0 <sub>dec</sub> )
	8021:02	Output 2	RW	0x00 (0 <sub>dec</sub> )
	8021:03	Output 3	RW	0x00 (0 <sub>dec</sub> )
	8021:04	Output 4	RW	0x00 (0 <sub>dec</sub> )
	8021:05	Output 5	RW	0x00 (0 <sub>dec</sub> )
	8021:06	Output 6	RW	0x00 (0 <sub>dec</sub> )
	8021:07	Output 7	RW	0x00 (0 <sub>dec</sub> )
	8021:08	Output 8	RW	0x00 (0 <sub>dec</sub> )
F000:0 [▶ 180]	<b>Subindex</b>	Modular device profile	RO	0x02 (2 <sub>dec</sub> )
	F000:01	Module index distance	RO	0x0010 (16 <sub>dec</sub> )
	F000:02	Maximum number of modules	RO	0x0003 (3 <sub>dec</sub> )
F008 [▶ 180]		Code word	RW	0x00000000 (0 <sub>dec</sub> )

F010:0 [▶ 180]	<b>Subindex</b>	Module list	RW	0x03 (3 <sub>dec</sub> )
	F010:01	SubIndex 001	RW	0x00000118 (280 <sub>dec</sub> )
	F010:02	SubIndex 002	RW	0x00000118 (280 <sub>dec</sub> )
	F010:03	SubIndex 003	RW	0x00000118 (280 <sub>dec</sub> )
F600:0 [▶ 181]	<b>Subindex</b>	DIG Inputs	RO	0x10 (16 <sub>dec</sub> )
	F600:01	Safe state active	RO	0x00 (0 <sub>dec</sub> )
	F600:02	Error channel 1	RO	0x00 (0 <sub>dec</sub> )
	F600:03	Error channel 2	RO	0x00 (0 <sub>dec</sub> )
	F600:04	Error channel 3	RO	0x00 (0 <sub>dec</sub> )
	F600:05	Us Undervoltage	RO	0x00 (0 <sub>dec</sub> )
	F600:06	Up Undervoltage	RO	0x00 (0 <sub>dec</sub> )
	F600:0E	Sync error	RO	0x00 (0 <sub>dec</sub> )
	F600:10	TxPDO Toggle	RO	0x00 (0 <sub>dec</sub> )
F700:0 [▶ 181]	<b>Subindex</b>	DIG Outputs	RO	0x02 (2 <sub>dec</sub> )
	F700:01	Set safe state	RO	0x00 (0 <sub>dec</sub> )
	F700:02	Reset outputs	RO	0x00 (0 <sub>dec</sub> )
F800:0 [▶ 181]	<b>Subindex</b>	DIG Settings	RW	0x11 (17 <sub>dec</sub> )
	F800:01	Disable shut off	RW	0x00 (0 <sub>dec</sub> )
	F800:11	Switch off time	RW	0x000A (10 <sub>dec</sub> )

**Key**

Flags:

RO = Read Only

RW = Read/Write

## 7.3.2 Object description and parameterization

### ● Parameterization

**i** The terminal is parameterized via the CoE - Online tab (double-click on the respective object) or via the Process Data tab (assignment of PDOs).

### ● EtherCAT XML Device Description

**i** The display matches that of the CoE objects from the EtherCAT XML Device Description. It is strongly recommended to download the latest revision of the corresponding XML file from the Beckhoff website (<http://www.beckhoff.com/english/default.htm?download/elconfig.htm>) and follow the installation instructions.

### Introduction

The CoE overview contains objects for different intended applications:

- [Objects required for parameterization \[► 168\]](#) during commissioning
- [Objects for indicating internal settings \[► 171\]](#) (may be fixed)
- Further [profile-specific objects \[► 178\]](#) indicating inputs, outputs and status information

The following section first describes the objects required for normal operation, followed by a complete overview of missing objects.

### Objects to be parameterized during commissioning

#### Index 1011 Restore default parameters

Index	Name	Meaning	Data type	Flags	Default
1011:0	Restore default parameters	Restore default settings	UINT8	RO	0x01 (1 <sub>dec</sub> )
1011:01	SubIndex 001	If this object is set to <b>0x64616F6C</b> in the set value dialog, all backup objects are reset to their delivery state.	UINT32	RW	0x00000000 (0 <sub>dec</sub> )

#### Index 8000 DIG Safe state active Ch.1

The outputs for which the *DIG Safe state active* bit is set are switched to the values specified in *Safe state value* in the event that the Operational (OP) status is left.

Status Operational (OP) is left if communication to the master is interrupted, for example at power breakdown at the master or cable breakage.

Index	Name	Meaning	Data type	Flags	Default
8000:0	DIG Safe state active		UINT8	RO	0x08 (8 <sub>dec</sub> )
8000:01	Output 1	0 <sub>bin</sub> : DIG Safe state for output 1 is switched off 1 <sub>bin</sub> : DIG Safe state for output 1 is switched on	boolean	RW	1 <sub>bin</sub>
8000:02	Output 2	0 <sub>bin</sub> : DIG Safe state for output 2 is switched off 1 <sub>bin</sub> : DIG Safe state for output 2 is switched on	boolean	RW	1 <sub>bin</sub>
8000:03	Output 3	0 <sub>bin</sub> : DIG Safe state for output 3 is switched off 1 <sub>bin</sub> : DIG Safe state for output 3 is switched on	boolean	RW	1 <sub>bin</sub>
8000:04	Output 4	0 <sub>bin</sub> : DIG Safe state for output 4 is switched off 1 <sub>bin</sub> : DIG Safe state for output 4 is switched on	boolean	RW	1 <sub>bin</sub>
8000:05	Output 5	0 <sub>bin</sub> : DIG Safe state for output 5 is switched off 1 <sub>bin</sub> : DIG Safe state for output 5 is switched on	boolean	RW	1 <sub>bin</sub>
8000:06	Output 6	0 <sub>bin</sub> : DIG Safe state for output 6 is switched off 1 <sub>bin</sub> : DIG Safe state for output 6 is switched on	boolean	RW	1 <sub>bin</sub>
8000:07	Output 7	0 <sub>bin</sub> : DIG Safe state for output 7 is switched off 1 <sub>bin</sub> : DIG Safe state for output 7 is switched on	boolean	RW	1 <sub>bin</sub>
8000:08	Output 8	0 <sub>bin</sub> : DIG Safe state for output 8 is switched off 1 <sub>bin</sub> : DIG Safe state for output 8 is switched on	boolean	RW	1 <sub>bin</sub>



**Index 8001 DIG Safe state value Ch.1**

The values to which the outputs are switched when the status Operational (OP) is left are specified here.

Index	Name	Meaning	Data type	Flags	Default
8001:0	DIG Safe state value		UINT8	RO	0x08 (8 <sub>dec</sub> )
8001:01	Output 1	0 <sub>bin</sub> : DIG Safe state value for output 1 = 0 1 <sub>bin</sub> : DIG Safe state value for output 1 = 1	boolean	RW	0x00 (0 <sub>dec</sub> )
8001:02	Output 2	0 <sub>bin</sub> : DIG Safe state value for output 2 = 0 1 <sub>bin</sub> : DIG Safe state value for output 2 = 1	boolean	RW	0x00 (0 <sub>dec</sub> )
8001:03	Output 3	0 <sub>bin</sub> : DIG Safe state value for output 3 = 0 1 <sub>bin</sub> : DIG Safe state value for output 3 = 1	boolean	RW	0x00 (0 <sub>dec</sub> )
8001:04	Output 4	0 <sub>bin</sub> : DIG Safe state value for output 4 = 0 1 <sub>bin</sub> : DIG Safe state value for output 4 = 1	boolean	RW	0x00 (0 <sub>dec</sub> )
8001:05	Output 5	0 <sub>bin</sub> : DIG Safe state value for output 5 = 0 1 <sub>bin</sub> : DIG Safe state value for output 5 = 1	boolean	RW	0x00 (0 <sub>dec</sub> )
8001:06	Output 6	0 <sub>bin</sub> : DIG Safe state value for output 6 = 0 1 <sub>bin</sub> : DIG Safe state value for output 6 = 1	boolean	RW	0x00 (0 <sub>dec</sub> )
8001:07	Output 7	0 <sub>bin</sub> : DIG Safe state value for output 7 = 0 1 <sub>bin</sub> : DIG Safe state value for output 7 = 1	boolean	RW	0x00 (0 <sub>dec</sub> )
8001:08	Output 8	0 <sub>bin</sub> : DIG Safe state value for output 8 = 0 1 <sub>bin</sub> : DIG Safe state value for output 8 = 1	boolean	RW	0x00 (0 <sub>dec</sub> )

**Index 8010 DIG Safe state active Ch.2**

The outputs for which the *DIG Safe state active* bit is set are switched to the values specified in *Safe state value* in the event that the Operational (OP) status is left.

Status Operational (OP) is left if communication to the master is interrupted, for example at power breakdown at the master or wire breakage.

Index	Name	Meaning	Data type	Flags	Default
8010:0	DIG Safe state active		UINT8	RO	0x08 (8 <sub>dec</sub> )
8010:01	Output 9	0 <sub>bin</sub> : DIG Safe state for output 9 is switched off 1 <sub>bin</sub> : DIG Safe state for output 9 is switched on	boolean	RW	1 <sub>bin</sub>
8010:02	Output 10	0 <sub>bin</sub> : DIG Safe state for output 10 is switched off 1 <sub>bin</sub> : DIG Safe state for output 10 is switched on	boolean	RW	1 <sub>bin</sub>
8010:03	Output 11	0 <sub>bin</sub> : DIG Safe state for output 11 is switched off 1 <sub>bin</sub> : DIG Safe state for output 11 is switched on	boolean	RW	1 <sub>bin</sub>
8010:04	Output 12	0 <sub>bin</sub> : DIG Safe state for output 12 is switched off 1 <sub>bin</sub> : DIG Safe state for output 12 is switched on	boolean	RW	1 <sub>bin</sub>
8010:05	Output 13	0 <sub>bin</sub> : DIG Safe state for output 13 is switched off 1 <sub>bin</sub> : DIG Safe state for output 13 is switched on	boolean	RW	1 <sub>bin</sub>
8010:06	Output 14	0 <sub>bin</sub> : DIG Safe state for output 14 is switched off 1 <sub>bin</sub> : DIG Safe state for output 14 is switched on	boolean	RW	1 <sub>bin</sub>
8010:07	Output 15	0 <sub>bin</sub> : DIG Safe state for output 15 is switched off 1 <sub>bin</sub> : DIG Safe state for output 15 is switched on	boolean	RW	1 <sub>bin</sub>
8010:08	Output 16	0 <sub>bin</sub> : DIG Safe state for output 16 is switched off 1 <sub>bin</sub> : DIG Safe state for output 16 is switched on	boolean	RW	1 <sub>bin</sub>

**Index 8011 DIG Safe state value Ch.2**

The values to which the outputs are switched when the status Operational (OP) is left are specified here.

Index	Name	Meaning	Data type	Flags	Default
8011:0	DIG Safe state value		UINT8	RO	0x08 (8 <sub>dec</sub> )
8011:01	Output 9	0 <sub>bin</sub> : DIG Safe state value for output 9 = 0 1 <sub>bin</sub> : DIG Safe state value for output 9 = 1	boolean	RW	0x00 (0 <sub>dec</sub> )
8011:02	Output 10	0 <sub>bin</sub> : DIG Safe state value for output 10 = 0 1 <sub>bin</sub> : DIG Safe state value for output 10 = 1	boolean	RW	0x00 (0 <sub>dec</sub> )
8011:03	Output 11	0 <sub>bin</sub> : DIG Safe state value for output 11 = 0 1 <sub>bin</sub> : DIG Safe state value for output 11 = 1	boolean	RW	0x00 (0 <sub>dec</sub> )
8011:04	Output 12	0 <sub>bin</sub> : DIG Safe state value for output 12 = 0 1 <sub>bin</sub> : DIG Safe state value for output 12 = 1	boolean	RW	0x00 (0 <sub>dec</sub> )
8011:05	Output 13	0 <sub>bin</sub> : DIG Safe state value for output 13 = 0 1 <sub>bin</sub> : DIG Safe state value for output 13 = 1	boolean	RW	0x00 (0 <sub>dec</sub> )
8011:06	Output 14	0 <sub>bin</sub> : DIG Safe state value for output 14 = 0 1 <sub>bin</sub> : DIG Safe state value for output 14 = 1	boolean	RW	0x00 (0 <sub>dec</sub> )
8011:07	Output 15	0 <sub>bin</sub> : DIG Safe state value for output 15 = 0 1 <sub>bin</sub> : DIG Safe state value for output 15 = 1	boolean	RW	0x00 (0 <sub>dec</sub> )
8011:08	Output 16	0 <sub>bin</sub> : DIG Safe state value for output 16 = 0 1 <sub>bin</sub> : DIG Safe state value for output 16 = 1	boolean	RW	0x00 (0 <sub>dec</sub> )

### Index 8020 DIG Safe state active Ch.3

The outputs for which the *DIG Safe state active* bit is set are switched to the values specified in *Safe state value* in the event that the Operational (OP) status is left.

Status Operational (OP) is left if communication to the master is interrupted, for example at power breakdown at the master or cable breakage.

Index	Name	Meaning	Data type	Flags	Default
8020:0	DIG Safe state active		UINT8	RO	0x08 (8 <sub>dec</sub> )
8020:01	Output 17	0 <sub>bin</sub> : DIG Safe state for output 17 is switched off 1 <sub>bin</sub> : DIG Safe state for output 17 is switched on	boolean	RW	1 <sub>bin</sub>
8020:02	Output 18	0 <sub>bin</sub> : DIG Safe state for output 18 is switched off 1 <sub>bin</sub> : DIG Safe state for output 18 is switched on	boolean	RW	1 <sub>bin</sub>
8020:03	Output 19	0 <sub>bin</sub> : DIG Safe state for output 19 is switched off 1 <sub>bin</sub> : DIG Safe state for output 19 is switched on	boolean	RW	1 <sub>bin</sub>
8020:04	Output 20	0 <sub>bin</sub> : DIG Safe state for output 20 is switched off 1 <sub>bin</sub> : DIG Safe state for output 20 is switched on	boolean	RW	1 <sub>bin</sub>
8020:05	Output 21	0 <sub>bin</sub> : DIG Safe state for output 21 is switched off 1 <sub>bin</sub> : DIG Safe state for output 21 is switched on	boolean	RW	1 <sub>bin</sub>
8020:06	Output 22	0 <sub>bin</sub> : DIG Safe state for output 22 is switched off 1 <sub>bin</sub> : DIG Safe state for output 22 is switched on	boolean	RW	1 <sub>bin</sub>
8020:07	Output 23	0 <sub>bin</sub> : DIG Safe state for output 23 is switched off 1 <sub>bin</sub> : DIG Safe state for output 23 is switched on	boolean	RW	1 <sub>bin</sub>
8020:08	Output 24	0 <sub>bin</sub> : DIG Safe state for output 24 is switched off 1 <sub>bin</sub> : DIG Safe state for output 24 is switched on	boolean	RW	1 <sub>bin</sub>

### Index 8021 DIG Safe state value Ch.3

The values to which the outputs are switched when the status Operational (OP) is left are specified here.

Index	Name	Meaning	Data type	Flags	Default
8021:0	DIG Safe state value		UINT8	RO	0x08 (8 <sub>dec</sub> )
8021:01	Output 17	0 <sub>bin</sub> : DIG Safe state value for output 17 = 0 1 <sub>bin</sub> : DIG Safe state value for output 17 = 1	boolean	RW	0 <sub>bin</sub>
8021:02	Output 18	0 <sub>bin</sub> : DIG Safe state value for output 18 = 0 1 <sub>bin</sub> : DIG Safe state value for output 18 = 1	boolean	RW	0 <sub>bin</sub>
8021:03	Output 19	0 <sub>bin</sub> : DIG Safe state value for output 19 = 0 1 <sub>bin</sub> : DIG Safe state value for output 19 = 1	boolean	RW	0 <sub>bin</sub>
8021:04	Output 20	0 <sub>bin</sub> : DIG Safe state value for output 20 = 0 1 <sub>bin</sub> : DIG Safe state value for output 20 = 1	boolean	RW	0 <sub>bin</sub>
8021:05	Output 21	0 <sub>bin</sub> : DIG Safe state value for output 21 = 0 1 <sub>bin</sub> : DIG Safe state value for output 21 = 1	boolean	RW	0 <sub>bin</sub>
8021:06	Output 22	0 <sub>bin</sub> : DIG Safe state value for output 22 = 0 1 <sub>bin</sub> : DIG Safe state value for output 22 = 1	boolean	RW	0 <sub>bin</sub>
8021:07	Output 23	0 <sub>bin</sub> : DIG Safe state value for output 23 = 0 1 <sub>bin</sub> : DIG Safe state value for output 23 = 1	boolean	RW	0 <sub>bin</sub>
8021:08	Output 24	0 <sub>bin</sub> : DIG Safe state value for output 24 = 0 1 <sub>bin</sub> : DIG Safe state value for output 24 = 1	boolean	RW	0 <sub>bin</sub>

**Further objects**

**Standard objects (0x1000-0x1FFF)**

The standard objects of all EtherCAT slaves have the same Meaning.

**Index 1000 Device type**

Index	Name	Meaning	Data type	Flags	Default
1000:0	Device type	Device type of the EtherCAT slave: The Lo-Word contains the supported CoE Profile (5001). The Hi-Word contains the Module Profile corresponding to the Modular Device Profile.	UINT32	RO	0x01181389 (18355081 <sub>dec</sub> )

**Index 1008 Device name**

Index	Name	Meaning	Data type	Flags	Default
1008:0	Device name	Device name of the EtherCAT slave	string	RO	EP2817-0008

**Index 1009 Hardware version**

Index	Name	Meaning	Data type	Flags	Default
1009:0	Hardware version	Hardware version of the EtherCAT slaves	string	RO	

**Index 100A Software version**

Index	Name	Meaning	Data type	Flags	Default
100A:0	Software version	Firmware version of the EtherCAT slaves	string	RO	00

**Index 1018 Identity**

Index	Name	Meaning	Data type	Flags	Default
1018:0	Identity	contains information to identify the EtherCAT slave	UINT8	RO	0x04 (4 <sub>dec</sub> )
1018:01	Vendor ID	Vendor ID of the EtherCAT slave	UINT32	RO	0x00000002 (2 <sub>dec</sub> )
1018:02	Product code	Product code of the EtherCAT slave	UINT32	RO	0x0B014052 (184631378 <sub>dec</sub> )
1018:03	Revision	Revision number of the EtherCAT-Slave, the Lo-Word (Bit 0-15) indicates the special functions terminal number; the Hi-Word (Bit 16-31) refers to the device description.	UINT32	RO	0x00000000 (0 <sub>dec</sub> )
1018:04	Serial number	Serial number of the EtherCAT-Slave, the Lo-Byte (Bit 0-7) of the Lo-Word contains the year of manufacturing, the Hi-Byte (Bit 8-15) of the Lo-Word contains the week of manufacturing, the Hi-Word (Bit 16-31) is 0 .	UINT32	RO	0x00000000 (0 <sub>dec</sub> )

**Index 10F0 Backup parameter handling**

Index	Name	Meaning	Data type	Flags	Default
10F0:0	Backup parameter handling	contains information for the standardized Upload and Download of the Backup Entries	UINT8	RO	0x01 (1 <sub>dec</sub> )
10F0:01	Checksum	Checksum over all backup entries	UINT32	RO	0x00000000 (0 <sub>dec</sub> )

**Index 1600 DIG RxPDO-Map OutputsCh.1**

Index	Name	Meaning	Data type	Flags	Default
1600:0	DIG RxPDO-Map OutputsCh.1	PDO Mapping RxPDO 1	UINT8	RO	0x09 (9 <sub>dec</sub> )
1600:01	SubIndex 001	1. PDO Mapping entry (object 0x7000 (DIG Outputs Ch.1), entry 0x01 (Output 1))	UINT32	RO	0x7000:01, 1
1600:02	SubIndex 002	2. PDO Mapping entry (object 0x7000 (DIG Outputs Ch.1), entry 0x02 (Output 2))	UINT32	RO	0x7000:02, 1
1600:03	SubIndex 003	3. PDO Mapping entry (object 0x7000 (DIG Outputs Ch.1), entry 0x03 (Output 3))	UINT32	RO	0x7000:03, 1
1600:04	SubIndex 004	4. PDO Mapping entry (object 0x7000 (DIG Outputs Ch.1), entry 0x04 (Output 4))	UINT32	RO	0x7000:04, 1
1600:05	SubIndex 005	5. PDO Mapping entry (object 0x7000 (DIG Outputs Ch.1), entry 0x05 (Output 5))	UINT32	RO	0x7000:05, 1
1600:06	SubIndex 006	6. PDO Mapping entry (object 0x7000 (DIG Outputs Ch.1), entry 0x06 (Output 6))	UINT32	RO	0x7000:06, 1
1600:07	SubIndex 007	7. PDO Mapping entry (object 0x7000 (DIG Outputs Ch.1), entry 0x07 (Output 7))	UINT32	RO	0x7000:07, 1
1600:08	SubIndex 008	8. PDO Mapping entry (object 0x7000 (DIG Outputs Ch.1), entry 0x08 (Output 8))	UINT32	RO	0x7000:08, 1
1600:09	SubIndex 009	9. PDO Mapping entry (8 bits align)	UINT32	RO	0x0000:00, 8

**Index 1601 DIG RxPDO-Map OutputsCh.2**

Index	Name	Meaning	Data type	Flags	Default
1601:0	DIG RxPDO-Map OutputsCh.2	PDO Mapping RxPDO 2	UINT8	RO	0x09 (9 <sub>dec</sub> )
1601:01	SubIndex 001	1. PDO Mapping entry (object 0x7010 (DIG Outputs Ch.2), entry 0x01 (Output 1))	UINT32	RO	0x7010:01, 1
1601:02	SubIndex 002	2. PDO Mapping entry (object 0x7010 (DIG Outputs Ch.2), entry 0x02 (Output 2))	UINT32	RO	0x7010:02, 1
1601:03	SubIndex 003	3. PDO Mapping entry (object 0x7010 (DIG Outputs Ch.2), entry 0x03 (Output 3))	UINT32	RO	0x7010:03, 1
1601:04	SubIndex 004	4. PDO Mapping entry (object 0x7010 (DIG Outputs Ch.2), entry 0x04 (Output 4))	UINT32	RO	0x7010:04, 1
1601:05	SubIndex 005	5. PDO Mapping entry (object 0x7010 (DIG Outputs Ch.2), entry 0x05 (Output 5))	UINT32	RO	0x7010:05, 1
1601:06	SubIndex 006	6. PDO Mapping entry (object 0x7010 (DIG Outputs Ch.2), entry 0x06 (Output 6))	UINT32	RO	0x7010:06, 1
1601:07	SubIndex 007	7. PDO Mapping entry (object 0x7010 (DIG Outputs Ch.2), entry 0x07 (Output 7))	UINT32	RO	0x7010:07, 1
1601:08	SubIndex 008	8. PDO Mapping entry (object 0x7010 (DIG Outputs Ch.2), entry 0x08 (Output 8))	UINT32	RO	0x7010:08, 1
1601:09	SubIndex 009	9. PDO Mapping entry (8 bits align)	UINT32	RO	0x0000:00, 8

**Index 1602 DIG RxPDO-Map OutputsCh.3**

Index	Name	Meaning	Data type	Flags	Default
1602:0	DIG RxPDO-Map OutputsCh.3	PDO Mapping RxPDO 3	UINT8	RO	0x09 (9 <sub>dec</sub> )
1602:01	SubIndex 001	1. PDO Mapping entry (object 0x7020 (DIG Outputs Ch.3), entry 0x01 (Output 1))	UINT32	RO	0x7020:01, 1
1602:02	SubIndex 002	2. PDO Mapping entry (object 0x7020 (DIG Outputs Ch.3), entry 0x02 (Output 2))	UINT32	RO	0x7020:02, 1
1602:03	SubIndex 003	3. PDO Mapping entry (object 0x7020 (DIG Outputs Ch.3), entry 0x03 (Output 3))	UINT32	RO	0x7020:03, 1
1602:04	SubIndex 004	4. PDO Mapping entry (object 0x7020 (DIG Outputs Ch.3), entry 0x04 (Output 4))	UINT32	RO	0x7020:04, 1
1602:05	SubIndex 005	5. PDO Mapping entry (object 0x7020 (DIG Outputs Ch.3), entry 0x05 (Output 5))	UINT32	RO	0x7020:05, 1
1602:06	SubIndex 006	6. PDO Mapping entry (object 0x7020 (DIG Outputs Ch.3), entry 0x06 (Output 6))	UINT32	RO	0x7020:06, 1
1602:07	SubIndex 007	7. PDO Mapping entry (object 0x7020 (DIG Outputs Ch.3), entry 0x07 (Output 7))	UINT32	RO	0x7020:07, 1
1602:08	SubIndex 008	8. PDO Mapping entry (object 0x7020 (DIG Outputs Ch.3), entry 0x08 (Output 8))	UINT32	RO	0x7020:08, 1
1602:09	SubIndex 009	9. PDO Mapping entry (8 bits align)	UINT32	RO	0x0000:00, 8

**Index 1603 DIG RxPDO-Map Outputs Device**

Index	Name	Meaning	Data type	Flags	Default
1603:0	DIG RxPDO-Map Outputs Device	PDO Mapping RxPDO 4	UINT8	RO	0x03 (3 <sub>dec</sub> )
1603:01	SubIndex 001	1. PDO Mapping entry (object 0xF700 (DIG Outputs), entry 0x01 (Set safe state))	UINT32	RO	0xF700:01, 1
1603:02	SubIndex 002	2. PDO Mapping entry (object 0xF700 (DIG Outputs), entry 0x02 (Reset outputs))	UINT32	RO	0xF700:02, 1
1603:03	SubIndex 003	3. PDO Mapping entry (14 bits align)	UINT32	RO	0x0000:00, 14

**Index 1A00 DIG TxPDO-Map Diag Inputs Ch.1**

Index	Name	Meaning	Data type	Flags	Default
1A00:0	DIG TxPDO-Map Diag Inputs Ch.1	PDO Mapping TxPDO 1	UINT8	RO	0x09 (9 <sub>dec</sub> )
1A00:01	SubIndex 001	1. PDO Mapping entry (object 0x6001 (DIG Diag Inputs Ch.1), entry 0x01 (Diag Input 1))	UINT32	RO	0x6001:01, 1
1A00:02	SubIndex 002	2. PDO Mapping entry (object 0x6001 (DIG Diag Inputs Ch.1), entry 0x02 (Diag Input 2))	UINT32	RO	0x6001:02, 1
1A00:03	SubIndex 003	3. PDO Mapping entry (object 0x6001 (DIG Diag Inputs Ch.1), entry 0x03 (Diag Input 3))	UINT32	RO	0x6001:03, 1
1A00:04	SubIndex 004	4. PDO Mapping entry (object 0x6001 (DIG Diag Inputs Ch.1), entry 0x04 (Diag Input 4))	UINT32	RO	0x6001:04, 1
1A00:05	SubIndex 005	5. PDO Mapping entry (object 0x6001 (DIG Diag Inputs Ch.1), entry 0x05 (Diag Input 5))	UINT32	RO	0x6001:05, 1
1A00:06	SubIndex 006	6. PDO Mapping entry (object 0x6001 (DIG Diag Inputs Ch.1), entry 0x06 (Diag Input 6))	UINT32	RO	0x6001:06, 1
1A00:07	SubIndex 007	7. PDO Mapping entry (object 0x6001 (DIG Diag Inputs Ch.1), entry 0x07 (Diag Input 7))	UINT32	RO	0x6001:07, 1
1A00:08	SubIndex 008	8. PDO Mapping entry (object 0x6001 (DIG Diag Inputs Ch.1), entry 0x08 (Diag Input 8))	UINT32	RO	0x6001:08, 1
1A00:09	SubIndex 009	9. PDO Mapping entry (8 bits align)	UINT32	RO	0x0000:00, 8

**Index 1A01 DIG TxPDO-Map Diag Inputs Ch.2**

Index	Name	Meaning	Data type	Flags	Default
1A01:0	DIG TxPDO-Map Diag Inputs Ch.2	PDO Mapping TxPDO 2	UINT8	RO	0x09 (9 <sub>dec</sub> )
1A01:01	SubIndex 001	1. PDO Mapping entry (object 0x6011 (DIG Diag Inputs Ch.2), entry 0x01 (Diag Input 1))	UINT32	RO	0x6011:01, 1
1A01:02	SubIndex 002	2. PDO Mapping entry (object 0x6011 (DIG Diag Inputs Ch.2), entry 0x02 (Diag Input 2))	UINT32	RO	0x6011:02, 1
1A01:03	SubIndex 003	3. PDO Mapping entry (object 0x6011 (DIG Diag Inputs Ch.2), entry 0x03 (Diag Input 3))	UINT32	RO	0x6011:03, 1
1A01:04	SubIndex 004	4. PDO Mapping entry (object 0x6011 (DIG Diag Inputs Ch.2), entry 0x04 (Diag Input 4))	UINT32	RO	0x6011:04, 1
1A01:05	SubIndex 005	5. PDO Mapping entry (object 0x6011 (DIG Diag Inputs Ch.2), entry 0x05 (Diag Input 5))	UINT32	RO	0x6011:05, 1
1A01:06	SubIndex 006	6. PDO Mapping entry (object 0x6011 (DIG Diag Inputs Ch.2), entry 0x06 (Diag Input 6))	UINT32	RO	0x6011:06, 1
1A01:07	SubIndex 007	7. PDO Mapping entry (object 0x6011 (DIG Diag Inputs Ch.2), entry 0x07 (Diag Input 7))	UINT32	RO	0x6011:07, 1
1A01:08	SubIndex 008	8. PDO Mapping entry (object 0x6011 (DIG Diag Inputs Ch.2), entry 0x08 (Diag Input 8))	UINT32	RO	0x6011:08, 1
1A01:09	SubIndex 009	9. PDO Mapping entry (8 bits align)	UINT32	RO	0x0000:00, 8

**Index 1A02 DIG TxPDO-Map Diag Inputs Ch.3**

Index	Name	Meaning	Data type	Flags	Default
1A02:0	DIG TxPDO-Map Diag Inputs Ch.3	PDO Mapping TxPDO 3	UINT8	RO	0x09 (9 <sub>dec</sub> )
1A02:01	SubIndex 001	1. PDO Mapping entry (object 0x6021 (DIG Diag Inputs Ch.3), entry 0x01 (Diag Input 1))	UINT32	RO	0x6021:01, 1
1A02:02	SubIndex 002	2. PDO Mapping entry (object 0x6021 (DIG Diag Inputs Ch.3), entry 0x02 (Diag Input 2))	UINT32	RO	0x6021:02, 1
1A02:03	SubIndex 003	3. PDO Mapping entry (object 0x6021 (DIG Diag Inputs Ch.3), entry 0x03 (Diag Input 3))	UINT32	RO	0x6021:03, 1
1A02:04	SubIndex 004	4. PDO Mapping entry (object 0x6021 (DIG Diag Inputs Ch.3), entry 0x04 (Diag Input 4))	UINT32	RO	0x6021:04, 1
1A02:05	SubIndex 005	5. PDO Mapping entry (object 0x6021 (DIG Diag Inputs Ch.3), entry 0x05 (Diag Input 5))	UINT32	RO	0x6021:05, 1
1A02:06	SubIndex 006	6. PDO Mapping entry (object 0x6021 (DIG Diag Inputs Ch.3), entry 0x06 (Diag Input 6))	UINT32	RO	0x6021:06, 1
1A02:07	SubIndex 007	7. PDO Mapping entry (object 0x6021 (DIG Diag Inputs Ch.3), entry 0x07 (Diag Input 7))	UINT32	RO	0x6021:07, 1
1A02:08	SubIndex 008	8. PDO Mapping entry (object 0x6021 (DIG Diag Inputs Ch.3), entry 0x08 (Diag Input 8))	UINT32	RO	0x6021:08, 1
1A02:09	SubIndex 009	9. PDO Mapping entry (8 bits align)	UINT32	RO	0x0000:00, 8

**Index 1A03 DIG TxPDO-Map Inputs Device**

Index	Name	Meaning	Data type	Flags	Default
1A03:0	DIG TxPDO-Map Inputs Device	PDO Mapping TxPDO 4	UINT8	RO	0x0A (10 <sub>dec</sub> )
1A03:01	SubIndex 001	1. PDO Mapping entry (object 0xF600 (DIG Inputs), entry 0x01 (Safe state active))	UINT32	RO	0xF600:01, 1
1A03:02	SubIndex 002	2. PDO Mapping entry (object 0xF600 (DIG Inputs), entry 0x02 (Error channel 1))	UINT32	RO	0xF600:02, 1
1A03:03	SubIndex 003	3. PDO Mapping entry (object 0xF600 (DIG Inputs), entry 0x03 (Error channel 2))	UINT32	RO	0xF600:03, 1
1A03:04	SubIndex 004	4. PDO Mapping entry (object 0xF600 (DIG Inputs), entry 0x04 (Error channel 3))	UINT32	RO	0xF600:04, 1
1A03:05	SubIndex 005	5. PDO Mapping entry (object 0xF600 (DIG Inputs), entry 0x05 (Us Undervoltage))	UINT32	RO	0xF600:05, 1
1A03:06	SubIndex 006	6. PDO Mapping entry (object 0xF600 (DIG Inputs), entry 0x06 (Up Undervoltage))	UINT32	RO	0xF600:06, 1
1A03:07	SubIndex 007	7. PDO Mapping entry (7 bits align)	UINT32	RO	0x0000:00, 7
1A03:08	SubIndex 008	8. PDO Mapping entry (object 0xF600 (DIG Inputs), entry 0x0E (Sync error))	UINT32	RO	0xF600:0E, 1
1A03:09	SubIndex 009	9. PDO Mapping entry (1 bits align)	UINT32	RO	0x0000:00, 1
1A03:0A	SubIndex 010	10. PDO Mapping entry (object 0xF600 (DIG Inputs), entry 0x10 (TxPDO Toggle))	UINT32	RO	0xF600:10, 1

**Index 1C00 Sync manager type**

Index	Name	Meaning	Data type	Flags	Default
1C00:0	Sync manager type	Usage of the Sync Manager channels	UINT8	RO	0x04 (4 <sub>dec</sub> )
1C00:01	SubIndex 001	Sync-Manager Type Channel 1: Mailbox Write	UINT8	RO	0x01 (1 <sub>dec</sub> )
1C00:02	SubIndex 002	Sync-Manager Type Channel 2: Mailbox Read	UINT8	RO	0x02 (2 <sub>dec</sub> )
1C00:03	SubIndex 003	Sync-Manager Type Channel 3: Process Data Write (Outputs)	UINT8	RO	0x03 (3 <sub>dec</sub> )
1C00:04	SubIndex 004	Sync-Manager Type Channel 4: Process Data Read (Inputs)	UINT8	RO	0x04 (4 <sub>dec</sub> )

**Index 1C12 RxPDO assign**

Index	Name	Meaning	Data type	Flags	Default
1C12:0	RxPDO assign	PDO Assign Outputs	UINT8	RW	0x04 (4 <sub>dec</sub> )
1C12:01	Subindex 001	1. assigned RxPDO (contains the index of the corresponding RxPDO Mapping object)	UINT16	RW	0x1600 (5632 <sub>dec</sub> )
1C12:02	Subindex 002	2. assigned RxPDO (contains the index of the corresponding RxPDO Mapping object)	UINT16	RW	0x1601 (5633 <sub>dec</sub> )
1C12:03	Subindex 003	3. assigned RxPDO (contains the index of the corresponding RxPDO Mapping object)	UINT16	RW	0x1602 (5634 <sub>dec</sub> )
1C12:04	Subindex 004	4. assigned RxPDO (contains the index of the corresponding RxPDO Mapping object)	UINT16	RW	0x1603 (5635 <sub>dec</sub> )

**Index 1C13 TxPDO assign**

Index	Name	Meaning	Data type	Flags	Default
1C13:0	TxPDO assign	PDO Assign Inputs	UINT8	RW	0x04 (4 <sub>dec</sub> )
1C13:01	Subindex 001	1. assigned TxPDO (contains the index of the corresponding TxPDO Mapping object)	UINT16	RW	0x1A00 (6656 <sub>dec</sub> )
1C13:02	Subindex 002	2. assigned TxPDO (contains the index of the corresponding TxPDO Mapping object)	UINT16	RW	0x1A01 (6657 <sub>dec</sub> )
1C13:03	Subindex 003	3. assigned TxPDO (contains the index of the corresponding TxPDO Mapping object)	UINT16	RW	0x1A02 (6658 <sub>dec</sub> )
1C13:04	Subindex 004	4. assigned TxPDO (contains the index of the corresponding TxPDO Mapping object)	UINT16	RW	0x1A03 (6659 <sub>dec</sub> )



**Index 1C32SM Output parameter**

Index	Name	Meaning	Data type	Flags	Default
1C32:0	SM output parameter	Synchronization parameter of the outputs	UINT8	RO	0x20 (32 <sub>dec</sub> )
1C32:01	Sync mode	actual synchronization mode: <ul style="list-style-type: none"> <li>0: Free Run</li> <li>1: Synchronous with SM 2 Event</li> <li>2: DC-Mode - Synchronous with SYNC0 Event</li> <li>3: DC-Mode - Synchronous with SYNC1 Event</li> </ul>	UINT16	RW	0x0001 (1 <sub>dec</sub> )
1C32:02	Cycle time	Cycle time (in ns): <ul style="list-style-type: none"> <li>Free Run: cycle time of the local timer</li> <li>Synchronous with SM 2 Event: Cycle time of the master</li> <li>DC mode: SYNC0/SYNC1 Cycle Time</li> </ul>	UINT32	RW	0x003D0900 (4000000 <sub>dec</sub> )
1C32:03	Shift time	Time between SYNC0 Event and Outputs Valid (in ns, only in DC-Mode)	UINT32	RO	0x00000000 (0 <sub>dec</sub> )
1C32:04	Sync modes supported	Supported synchronization modes: <ul style="list-style-type: none"> <li>Bit 0 = 1: Free Run is supported</li> <li>Bit 1 = 1: Synchronous with SM 2 Event is supported</li> <li>Bit 2-3 = 01: DC mode is supported</li> <li>Bit 4-5 = 10: Output Shift with SYNC1 Event (only DC-Mode)</li> <li>Bit 14 = 1: dynamic times (could be measured by writing <a href="#">1C32:08</a> [<a href="#">177</a>])</li> </ul>	UINT16	RO	0x000A (10 <sub>dec</sub> )
1C32:05	Minimum cycle time	Minimum cycle time supported (in ns)	UINT32	RO	0x000493E0 (300000 <sub>dec</sub> )
1C32:06	Calc and copy time	Minimal time between SYNC0 and SYNC1 Event (in ns, only in DC-Mode)	UINT32	RO	0x00000000 (0 <sub>dec</sub> )
1C32:07	Minimum delay time		UINT32	RO	0x00000000 (0 <sub>dec</sub> )
1C32:08	Command	<ul style="list-style-type: none"> <li>0: Measurement of the times will be stopped</li> <li>1: Measurement of the times will be started</li> </ul> <p>The Entries <a href="#">1C32:03</a> [<a href="#">177</a>], <a href="#">1C32:05</a> [<a href="#">177</a>], <a href="#">1C32:06</a> [<a href="#">177</a>], <a href="#">1C32:09</a> [<a href="#">177</a>], <a href="#">1C33:03</a> [<a href="#">178</a>], <a href="#">1C33:06</a> [<a href="#">177</a>], <a href="#">1C33:09</a> [<a href="#">178</a>] will be updated with the maximum measured values.</p>	UINT16	RW	0x0000 (0 <sub>dec</sub> )
1C32:09	Maximum delay time	Time between SYNC1 Event and Outputs Valid (in ns, only in DC-Mode)	UINT32	RO	0x00000000 (0 <sub>dec</sub> )
1C32:0B	SM event missed counter	Number of the missed SM-Events in state OPERATIONAL (only in DC Mode)	UINT16	RO	0x0000 (0 <sub>dec</sub> )
1C32:0C	Cycle exceeded counter	Number of exceeded cycles in state OPERATIONAL	UINT16	RO	0x0000 (0 <sub>dec</sub> )
1C32:0D	Shift too short counter	Number of inadequate distances between SYNC0 and SYNC1 events (only in DC Mode)	UINT16	RO	0x0000 (0 <sub>dec</sub> )
1C32:20	Sync error	TRUE: In the last cycle the synchronization was not correct (only in DC Mode)	boolean	RO	0x00 (0 <sub>dec</sub> )

## Index 1C33 SM input parameter

Index	Name	Meaning	Data type	Flags	Default
1C33:0	SM input parameter	Synchronization parameter of the inputs	UINT8	RO	0x20 (32 <sub>dec</sub> )
1C33:01	Sync mode	actual synchronization mode: <ul style="list-style-type: none"> <li>0: Free Run</li> <li>1: Synchronous with SM 3 Event (no Outputs available)</li> <li>2: DC - Synchronous with SYNC0 Event</li> <li>3: DC - Synchronous with SYNC1 Event</li> <li>34: Synchronous with SM 2 Event (Outputs available)</li> </ul>	UINT16	RW	0x0022 (34 <sub>dec</sub> )
1C33:02	Cycle time	same as <a href="#">1C32:02 [▶ 177]</a>	UINT32	RW	0x003D0900 (4000000 <sub>dec</sub> )
1C33:03	Shift time	time between SYNC0-Event and Input Latch (in ns, only in DC-Mode)	UINT32	RO	0x00000000 (0 <sub>dec</sub> )
1C33:04	Sync modes supported	Supported synchronization modes: <ul style="list-style-type: none"> <li>Bit 0: Free Run is supported</li> <li>Bit 1: Synchronous with SM 2 Event is supported (Outputs available)</li> <li>Bit 1: Synchronous with SM 3 Event is supported (no Outputs available)</li> <li>Bit 2-3 = 01: DC mode is supported</li> <li>Bit 4-5 = 01: Input Shift with local event (Outputs available)</li> <li>Bit 4-5 = 10: Input Shift with SYNC1 Event (no Outputs available)</li> <li>Bit 14 = 1: dynamic times (could be measured by writing <a href="#">1C32:08 [▶ 177]</a> or <a href="#">1C33:08 [▶ 178]</a>)</li> </ul>	UINT16	RO	0x000A (10 <sub>dec</sub> )
1C33:05	Minimum cycle time	same as <a href="#">1C32:05 [▶ 177]</a>	UINT32	RO	0x000493E0 (300000 <sub>dec</sub> )
1C33:06	Calc and copy time	time between Input Latch and the availability of the inputs for the master (in ns, only in DC-Mode)	UINT32	RO	0x00000000 (0 <sub>dec</sub> )
1C33:07	Minimum delay time		UINT32	RO	0x00000000 (0 <sub>dec</sub> )
1C33:08	Command	same as <a href="#">1C32:08 [▶ 177]</a>	UINT16	RW	0x0000 (0 <sub>dec</sub> )
1C33:09	Maximum delay time	time between SYNC1-Event and Input Latch (in ns, only in DC-Mode)	UINT32	RO	0x00000000 (0 <sub>dec</sub> )
1C33:0B	SM event missed counter	same as <a href="#">1C32:11 [▶ 177]</a>	UINT16	RO	0x0000 (0 <sub>dec</sub> )
1C33:0C	Cycle exceeded counter	same as <a href="#">1C32:12 [▶ 177]</a>	UINT16	RO	0x0000 (0 <sub>dec</sub> )
1C33:0D	Shift too short counter	same as <a href="#">1C32:13 [▶ 177]</a>	UINT16	RO	0x0000 (0 <sub>dec</sub> )
1C33:20	Sync error	same as <a href="#">1C32:32 [▶ 177]</a>	boolean	RO	0x00 (0 <sub>dec</sub> )

## Profile specific objects (0x6000-0xFFFF)

The profile specific objects have the same meaning for all EtherCAT Slaves which support the profile 5001.

**Index 6001 DIG Diag Inputs Ch.1**

Index	Name	Meaning	Data type	Flags	Default
6001:0	DIG Diag Inputs Ch.1		UINT8	RO	0x08 (8 <sub>dec</sub> )
6001:01	Diag Input 1		boolean	RO	0x00 (0 <sub>dec</sub> )
6001:02	Diag Input 2		boolean	RO	0x00 (0 <sub>dec</sub> )
6001:03	Diag Input 3		boolean	RO	0x00 (0 <sub>dec</sub> )
6001:04	Diag Input 4		boolean	RO	0x00 (0 <sub>dec</sub> )
6001:05	Diag Input 5		boolean	RO	0x00 (0 <sub>dec</sub> )
6001:06	Diag Input 6		boolean	RO	0x00 (0 <sub>dec</sub> )
6001:07	Diag Input 7		boolean	RO	0x00 (0 <sub>dec</sub> )
6001:08	Diag Input 8		boolean	RO	0x00 (0 <sub>dec</sub> )

**Index 6011 DIG Diag Inputs Ch.2**

Index	Name	Meaning	Data type	Flags	Default
6011:0	DIG Diag Inputs Ch.2		UINT8	RO	0x08 (8 <sub>dec</sub> )
6011:01	Diag Input 1		boolean	RO	0x00 (0 <sub>dec</sub> )
6011:02	Diag Input 2		boolean	RO	0x00 (0 <sub>dec</sub> )
6011:03	Diag Input 3		boolean	RO	0x00 (0 <sub>dec</sub> )
6011:04	Diag Input 4		boolean	RO	0x00 (0 <sub>dec</sub> )
6011:05	Diag Input 5		boolean	RO	0x00 (0 <sub>dec</sub> )
6011:06	Diag Input 6		boolean	RO	0x00 (0 <sub>dec</sub> )
6011:07	Diag Input 7		boolean	RO	0x00 (0 <sub>dec</sub> )
6011:08	Diag Input 8		boolean	RO	0x00 (0 <sub>dec</sub> )

**Index 6021 DIG Diag Inputs Ch.3**

Index	Name	Meaning	Data type	Flags	Default
6021:0	DIG Diag Inputs Ch.3		UINT8	RO	0x08 (8 <sub>dec</sub> )
6021:01	Diag Input 1		boolean	RO	0x00 (0 <sub>dec</sub> )
6021:02	Diag Input 2		boolean	RO	0x00 (0 <sub>dec</sub> )
6021:03	Diag Input 3		boolean	RO	0x00 (0 <sub>dec</sub> )
6021:04	Diag Input 4		boolean	RO	0x00 (0 <sub>dec</sub> )
6021:05	Diag Input 5		boolean	RO	0x00 (0 <sub>dec</sub> )
6021:06	Diag Input 6		boolean	RO	0x00 (0 <sub>dec</sub> )
6021:07	Diag Input 7		boolean	RO	0x00 (0 <sub>dec</sub> )
6021:08	Diag Input 8		boolean	RO	0x00 (0 <sub>dec</sub> )

**Index 7000 DIG Outputs Ch.1**

Index	Name	Meaning	Data type	Flags	Default
7000:0	DIG Outputs Ch.1		UINT8	RO	0x08 (8 <sub>dec</sub> )
7000:01	Output 1		boolean	RO	0x00 (0 <sub>dec</sub> )
7000:02	Output 2		boolean	RO	0x00 (0 <sub>dec</sub> )
7000:03	Output 3		boolean	RO	0x00 (0 <sub>dec</sub> )
7000:04	Output 4		boolean	RO	0x00 (0 <sub>dec</sub> )
7000:05	Output 5		boolean	RO	0x00 (0 <sub>dec</sub> )
7000:06	Output 6		boolean	RO	0x00 (0 <sub>dec</sub> )
7000:07	Output 7		boolean	RO	0x00 (0 <sub>dec</sub> )
7000:08	Output 8		boolean	RO	0x00 (0 <sub>dec</sub> )

**Index 7010 DIG Outputs Ch.2**

Index	Name	Meaning	Data type	Flags	Default
7010:0	DIG Outputs Ch.2		UINT8	RO	0x08 (8 <sub>dec</sub> )
7010:01	Output 1		boolean	RO	0x00 (0 <sub>dec</sub> )
7010:02	Output 2		boolean	RO	0x00 (0 <sub>dec</sub> )
7010:03	Output 3		boolean	RO	0x00 (0 <sub>dec</sub> )
7010:04	Output 4		boolean	RO	0x00 (0 <sub>dec</sub> )
7010:05	Output 5		boolean	RO	0x00 (0 <sub>dec</sub> )
7010:06	Output 6		boolean	RO	0x00 (0 <sub>dec</sub> )
7010:07	Output 7		boolean	RO	0x00 (0 <sub>dec</sub> )
7010:08	Output 8		boolean	RO	0x00 (0 <sub>dec</sub> )

**Index 7020 DIG Outputs Ch.3**

Index	Name	Meaning	Data type	Flags	Default
7020:0	DIG Outputs Ch.3		UINT8	RO	0x08 (8 <sub>dec</sub> )
7020:01	Output 1		boolean	RO	0x00 (0 <sub>dec</sub> )
7020:02	Output 2		boolean	RO	0x00 (0 <sub>dec</sub> )
7020:03	Output 3		boolean	RO	0x00 (0 <sub>dec</sub> )
7020:04	Output 4		boolean	RO	0x00 (0 <sub>dec</sub> )
7020:05	Output 5		boolean	RO	0x00 (0 <sub>dec</sub> )
7020:06	Output 6		boolean	RO	0x00 (0 <sub>dec</sub> )
7020:07	Output 7		boolean	RO	0x00 (0 <sub>dec</sub> )
7020:08	Output 8		boolean	RO	0x00 (0 <sub>dec</sub> )

**Index F000 Modular device profile**

Index	Name	Meaning	Data type	Flags	Default
F000:0	Modular device profile	general information about the Modular Device Profile	UINT8	RO	0x02 (2 <sub>dec</sub> )
F000:01	Module index distance	Index distance between the objects of two channels	UINT16	RO	0x0010 (16 <sub>dec</sub> )
F000:02	Maximum number of modules	number of channels	UINT16	RO	0x0003 (3 <sub>dec</sub> )

**Index F008 Code word**

Index	Name	Meaning	Data type	Flags	Default
F008:0	Code word		UINT32	RW	0x00000000 (0 <sub>dec</sub> )

**Index F010 Module list**

Index	Name	Meaning	Data type	Flags	Default
F010:0	Module list		UINT8	RW	0x03 (3 <sub>dec</sub> )
F010:01	SubIndex 001		UINT32	RW	0x00000118 (280 <sub>dec</sub> )
F010:02	SubIndex 002		UINT32	RW	0x00000118 (280 <sub>dec</sub> )
F010:03	SubIndex 003		UINT32	RW	0x00000118 (280 <sub>dec</sub> )

**Index F600 DIG Inputs**

Index	Name	Meaning	Data type	Flags	Default
F600:0	DIG Inputs		UINT8	RO	0x10 (16 <sub>dec</sub> )
F600:01	Safe state active		boolean	RO	0x00 (0 <sub>dec</sub> )
F600:02	Error channel 1		boolean	RO	0x00 (0 <sub>dec</sub> )
F600:03	Error channel 2		boolean	RO	0x00 (0 <sub>dec</sub> )
F600:04	Error channel 3		boolean	RO	0x00 (0 <sub>dec</sub> )
F600:05	Us Undervoltage		boolean	RO	0x00 (0 <sub>dec</sub> )
F600:06	Up Undervoltage		boolean	RO	0x00 (0 <sub>dec</sub> )
F600:0E	Sync error		boolean	RO	0x00 (0 <sub>dec</sub> )
F600:10	TxPDO Toggle		boolean	RO	0x00 (0 <sub>dec</sub> )

**Index F700 DIG Outputs**

Index	Name	Meaning	Data type	Flags	Default
F700:0	DIG Outputs		UINT8	RO	0x02 (2 <sub>dec</sub> )
F700:01	Set safe state		boolean	RO	0x00 (0 <sub>dec</sub> )
F700:02	Reset outputs		boolean	RO	0x00 (0 <sub>dec</sub> )

**Index F800 DIG Settings**

Index	Name	Meaning	Data type	Flags	Default
F800:0	DIG Settings		UINT8	RO	0x11 (17 <sub>dec</sub> )
F800:01	Disable shut off		boolean	RW	0x00 (0 <sub>dec</sub> )
F800:11	Switch off time		UINT16	RW	0x000A (10 <sub>dec</sub> )

## 7.4 EP2839-00x2

### 7.4.1 Object overview

Index	Name	Flags	Default value
1000 <a href="#">[▶ 190]</a>	Device type	RO	0x00C81389 (13112201 <sub>dec</sub> )
1008 <a href="#">[▶ 190]</a>	Device name	RO	EP2839-0042
1009 <a href="#">[▶ 190]</a>	Hardware version	RO	
100A <a href="#">[▶ 190]</a>	Software version	RO	00
100B <a href="#">[▶ 190]</a>	Bootloader version	RO	N/A
1011:0 <a href="#">[▶ 190]</a>	<b>SubIndex</b> Restore default parameters	RO	0x01 (1 <sub>dec</sub> )
	1011:01 SubIndex 001	RW	0x00000000 (0 <sub>dec</sub> )
1018:0 <a href="#">[▶ 190]</a>	<b>SubIndex</b> Identity	RO	0x04 (4 <sub>dec</sub> )
	1018:01 Vendor ID	RO	0x00000002 (2 <sub>dec</sub> )
	1018:02 Product code	RO	0x0B174052 (186073170 <sub>dec</sub> )
	1018:03 Revision	RO	0x00000000 (0 <sub>dec</sub> )
	1018:04 Serial number	RO	0x00000000 (0 <sub>dec</sub> )
10E2:0 <a href="#">[▶ 191]</a>	<b>SubIndex</b> Manufacturer-specific Identification Code	RO	0x01 (1 <sub>dec</sub> )
	10E2:01 SubIndex 001	RO	
10F0:0 <a href="#">[▶ 191]</a>	<b>SubIndex</b> Backup parameter handling	RO	0x01 (1 <sub>dec</sub> )
	10F0:01 Checksum	RO	0x00000000 (0 <sub>dec</sub> )
10F3:0 <a href="#">[▶ 191]</a>	<b>SubIndex</b> Diagnosis History	RO	0x15 (21 <sub>dec</sub> )
	10F3:01 Maximum Messages	RO	0x00 (0 <sub>dec</sub> )
	10F3:02 Newest Message	RO	0x00 (0 <sub>dec</sub> )
	10F3:03 Newest Acknowledged Message	RW	0x00 (0 <sub>dec</sub> )
	10F3:04 New Messages Available	RO	0x00 (0 <sub>dec</sub> )
	10F3:05 Flags	RW	0x0000 (0 <sub>dec</sub> )
	10F3:06 Diagnosis Message 001	RO	{0}
	10F3:07 Diagnosis Message 002	RO	{0}
	10F3:08 Diagnosis Message 003	RO	{0}
	10F3:09 Diagnosis Message 004	RO	{0}
	10F3:0A Diagnosis Message 005	RO	{0}
	10F3:0B Diagnosis Message 006	RO	{0}
	10F3:0C Diagnosis Message 007	RO	{0}
	10F3:0D Diagnosis Message 008	RO	{0}
	10F3:0E Diagnosis Message 009	RO	{0}
	10F3:0F Diagnosis Message 010	RO	{0}
	10F3:10 Diagnosis Message 011	RO	{0}
	10F3:11 Diagnosis Message 012	RO	{0}
	10F3:12 Diagnosis Message 013	RO	{0}
	10F3:13 Diagnosis Message 014	RO	{0}
	10F3:14 Diagnosis Message 015	RO	{0}
	10F3:15 Diagnosis Message 016	RO	{0}
10F8 <a href="#">[▶ 191]</a>	Timestamp Object	RO	
10F9:0 <a href="#">[▶ 191]</a>	<b>SubIndex</b> Time Distribution Object	RO	0x01 (1 <sub>dec</sub> )
	10F9:01 Distributed Time Value	RW	

Index	Name	Flags	Default value
1600:0 [▶ 192]	<b>SubIndex</b> DO RxPDO-Map Output	RO	0x10 (16 <sub>dec</sub> )
1600:01	SubIndex 001	RO	0x7000:01, 1
1600:02	SubIndex 002	RO	0x7010:01, 1
1600:03	SubIndex 003	RO	0x7020:01, 1
1600:04	SubIndex 004	RO	0x7030:01, 1
1600:05	SubIndex 005	RO	0x7040:01, 1
1600:06	SubIndex 006	RO	0x7050:01, 1
1600:07	SubIndex 007	RO	0x7060:01, 1
1600:08	SubIndex 008	RO	0x7070:01, 1
1600:09	SubIndex 009	RO	0x7080:01, 1
1600:0A	SubIndex 010	RO	0x7090:01, 1
1600:0B	SubIndex 011	RO	0x70A0:01, 1
1600:0C	SubIndex 012	RO	0x70B0:01, 1
1600:0D	SubIndex 013	RO	0x70C0:01, 1
1600:0E	SubIndex 014	RO	0x70D0:01, 1
1600:0F	SubIndex 015	RO	0x70E0:01, 1
1600:10	SubIndex 016	RO	0x70F0:01, 1
1A00:0 [▶ 193]	<b>SubIndex</b> DO TxPDO-Map Diagnosis	RO	0x40 (64 <sub>dec</sub> )
1A00:01	SubIndex 001	RO	0x6002:01, 1
1A00:02	SubIndex 002	RO	0x6002:02, 1
1A00:03	SubIndex 003	RO	0x6002:03, 1
1A00:04	SubIndex 004	RO	0x6002:04, 1
1A00:05	SubIndex 005	RO	0x6012:01, 1
1A00:06	SubIndex 006	RO	0x6012:02, 1
1A00:07	SubIndex 007	RO	0x6012:03, 1
1A00:08	SubIndex 008	RO	0x6012:04, 1
1A00:09	SubIndex 009	RO	0x6022:01, 1
1A00:0A	SubIndex 010	RO	0x6022:02, 1
1A00:0B	SubIndex 011	RO	0x6022:03, 1
1A00:0C	SubIndex 012	RO	0x6022:04, 1
1A00:0D	SubIndex 013	RO	0x6032:01, 1
1A00:0E	SubIndex 014	RO	0x6032:02, 1
1A00:0F	SubIndex 015	RO	0x6032:03, 1
1A00:10	SubIndex 016	RO	0x6032:04, 1
1A00:11	SubIndex 017	RO	0x6042:01, 1
1A00:12	SubIndex 018	RO	0x6042:02, 1
1A00:13	SubIndex 019	RO	0x6042:03, 1
1A00:14	SubIndex 020	RO	0x6042:04, 1
1A00:15	SubIndex 021	RO	0x6052:01, 1
1A00:16	SubIndex 022	RO	0x6052:02, 1
1A00:17	SubIndex 023	RO	0x6052:03, 1
1A00:18	SubIndex 024	RO	0x6052:04, 1
1A00:19	SubIndex 025	RO	0x6062:01, 1
1A00:1A	SubIndex 026	RO	0x6062:02, 1
1A00:1B	SubIndex 027	RO	0x6062:03, 1
1A00:1C	SubIndex 028	RO	0x6062:04, 1
1A00:1D	SubIndex 029	RO	0x6072:01, 1
1A00:1E	SubIndex 030	RO	0x6072:02, 1
1A00:1F	SubIndex 031	RO	0x6072:03, 1
1A00:20	SubIndex 032	RO	0x6072:04, 1
1A00:21	SubIndex 033	RO	0x6082:01, 1
1A00:22	SubIndex 034	RO	0x6082:02, 1
1A00:23	SubIndex 035	RO	0x6082:03, 1
1A00:24	SubIndex 036	RO	0x6082:04, 1
1A00:25	SubIndex 037	RO	0x6092:01, 1

Index	Name	Flags	Default value	
	1A00:26	SubIndex 038	RO	0x6092:02, 1
	1A00:27	SubIndex 039	RO	0x6092:03, 1
	1A00:28	SubIndex 040	RO	0x6092:04, 1
	1A00:29	SubIndex 041	RO	0x60A2:01, 1
	1A00:2A	SubIndex 042	RO	0x60A2:02, 1
	1A00:2B	SubIndex 043	RO	0x60A2:03, 1
	1A00:2C	SubIndex 044	RO	0x60A2:04, 1
	1A00:2D	SubIndex 045	RO	0x60B2:01, 1
	1A00:2E	SubIndex 046	RO	0x60B2:02, 1
	1A00:2F	SubIndex 047	RO	0x60B2:03, 1
	1A00:30	SubIndex 048	RO	0x60B2:04, 1
	1A00:31	SubIndex 049	RO	0x60C2:01, 1
	1A00:32	SubIndex 050	RO	0x60C2:02, 1
	1A00:33	SubIndex 051	RO	0x60C2:03, 1
	1A00:34	SubIndex 052	RO	0x60C2:04, 1
	1A00:35	SubIndex 053	RO	0x60D2:01, 1
	1A00:36	SubIndex 054	RO	0x60D2:02, 1
	1A00:37	SubIndex 055	RO	0x60D2:03, 1
	1A00:38	SubIndex 056	RO	0x60D2:04, 1
	1A00:39	SubIndex 057	RO	0x60E2:01, 1
	1A00:3A	SubIndex 058	RO	0x60E2:02, 1
	1A00:3B	SubIndex 059	RO	0x60E2:03, 1
	1A00:3C	SubIndex 060	RO	0x60E2:04, 1
	1A00:3D	SubIndex 061	RO	0x60F2:01, 1
	1A00:3E	SubIndex 062	RO	0x60F2:02, 1
	1A00:3F	SubIndex 063	RO	0x60F2:03, 1
	1A00:40	SubIndex 064	RO	0x60F2:04, 1
1A01:0 [▶ 195]	<b>SubIndex</b>	DEV TxPDO-Map Inputs Device	RO	0x07 (7 <sub>dec</sub> )
	1A01:01	SubIndex 001	RO	0xF600:01, 1
	1A01:02	SubIndex 002	RO	0xF600:02, 1
	1A01:03	SubIndex 003	RO	0xF600:03, 1
	1A01:04	SubIndex 004	RO	0x0000:00, 9
	1A01:05	SubIndex 005	RO	0xF600:0D, 1
	1A01:06	SubIndex 006	RO	0xF600:0E, 1
	1A01:07	SubIndex 007	RO	0xF600:0F, 2
1A02:0 [▶ 195]	<b>SubIndex</b>	DEV TxPDO Map Voltages	RO	0x02 (2 <sub>dec</sub> )
	1A02:01	SubIndex 001	RO	0xF600:16, 32
	1A02:02	SubIndex 002	RO	0xF600:17, 32
1C00:0 [▶ 195]	<b>SubIndex</b>	Sync manager type	RO	0x04 (4 <sub>dec</sub> )
	1C00:01	SubIndex 001	RO	0x01 (1 <sub>dec</sub> )
	1C00:02	SubIndex 002	RO	0x02 (2 <sub>dec</sub> )
	1C00:03	SubIndex 003	RO	0x03 (3 <sub>dec</sub> )
	1C00:04	SubIndex 004	RO	0x04 (4 <sub>dec</sub> )
1C12:0 [▶ 195]	<b>SubIndex</b>	RxPDO assign	RO	0x01 (1 <sub>dec</sub> )
	1C12:01	SubIndex 001	RO	0x1600 (5632 <sub>dec</sub> )
1C13:0 [▶ 195]	<b>SubIndex</b>	TxPDO assign	RW	0x01 (1 <sub>dec</sub> )
	1C13:01	SubIndex 001	RW	0x1A01 (6657 <sub>dec</sub> )
	1C13:02	SubIndex 002	RW	0x0000 (0 <sub>dec</sub> )
	1C13:03	SubIndex 003	RW	0x0000 (0 <sub>dec</sub> )



Index	Name	Flags	Default value	
1C32:0 <a href="#">▶ 196</a>	<b>SubIndex</b>	SM output parameter	RO	0x20 (32 <sub>dec</sub> )
	1C32:01	Sync mode	RW	0x0001 (1 <sub>dec</sub> )
	1C32:02	Cycle time	RW	0x000F4240 (1000000 <sub>dec</sub> )
	1C32:03	Shift time	RO	0x00000000 (0 <sub>dec</sub> )
	1C32:04	Sync modes supported	RO	0x440B (17419 <sub>dec</sub> )
	1C32:05	Minimum cycle time	RO	0x000186A0 (100000 <sub>dec</sub> )
	1C32:06	Calc and copy time	RO	0x00000000 (0 <sub>dec</sub> )
	1C32:07	Minimum delay time	RO	0x00000000 (0 <sub>dec</sub> )
	1C32:08	Get Cycle Time	RW	0x0000 (0 <sub>dec</sub> )
	1C32:09	Maximum delay time	RO	0x00000000 (0 <sub>dec</sub> )
	1C32:0B	SM event missed counter	RO	0x0000 (0 <sub>dec</sub> )
	1C32:0C	Cycle exceeded counter	RO	0x0000 (0 <sub>dec</sub> )
	1C32:0D	Shift too short counter	RO	0x0000 (0 <sub>dec</sub> )
	1C32:20	Sync error	RO	0x00 (0 <sub>dec</sub> )
1C33:0 <a href="#">▶ 196</a>	<b>SubIndex</b>	SM input parameter	RO	0x20 (32 <sub>dec</sub> )
	1C33:01	Sync mode	RW	0x0022 (34 <sub>dec</sub> )
	1C33:02	Cycle time	RW	0x000F4240 (1000000 <sub>dec</sub> )
	1C33:03	Shift time	RO	0x000186A0 (100000 <sub>dec</sub> )
	1C33:04	Sync modes supported	RO	0x440B (17419 <sub>dec</sub> )
	1C33:05	Minimum cycle time	RO	0x000186A0 (100000 <sub>dec</sub> )
	1C33:06	Calc and copy time	RO	0x00000000 (0 <sub>dec</sub> )
	1C33:07	Minimum delay time	RO	0x00000000 (0 <sub>dec</sub> )
	1C33:08	Get Cycle Time	RW	0x0000 (0 <sub>dec</sub> )
	1C33:09	Maximum delay time	RO	0x00000000 (0 <sub>dec</sub> )
	1C33:0B	SM event missed counter	RO	0x0000 (0 <sub>dec</sub> )
	1C33:0C	Cycle exceeded counter	RO	0x0000 (0 <sub>dec</sub> )
	1C33:0D	Shift too short counter	RO	0x0000 (0 <sub>dec</sub> )
	1C33:20	Sync error	RO	0x00 (0 <sub>dec</sub> )
6002:0 <a href="#">▶ 197</a>	<b>SubIndex</b>	DO Diagnosis Ch.01	RO	0x04 (4 <sub>dec</sub> )
	6002:01	Overcurrent	RO	0x00 (0 <sub>dec</sub> )
	6002:02	Overload	RO	0x00 (0 <sub>dec</sub> )
	6002:03	Open load	RO	0x00 (0 <sub>dec</sub> )
	6002:04	Short to 24V	RO	0x00 (0 <sub>dec</sub> )
6012:0 <a href="#">▶ 197</a>	<b>SubIndex</b>	DO Diagnosis Ch.02	RO	0x04 (4 <sub>dec</sub> )
	6012:01	Overcurrent	RO	0x00 (0 <sub>dec</sub> )
	6012:02	Overload	RO	0x00 (0 <sub>dec</sub> )
	6012:03	Open load	RO	0x00 (0 <sub>dec</sub> )
	6012:04	Short to 24V	RO	0x00 (0 <sub>dec</sub> )
6022:0 <a href="#">▶ 197</a>	<b>SubIndex</b>	DO Diagnosis Ch.03	RO	0x04 (4 <sub>dec</sub> )
	6022:01	Overcurrent	RO	0x00 (0 <sub>dec</sub> )
	6022:02	Overload	RO	0x00 (0 <sub>dec</sub> )
	6022:03	Open load	RO	0x00 (0 <sub>dec</sub> )
	6022:04	Short to 24V	RO	0x00 (0 <sub>dec</sub> )
6032:0 <a href="#">▶ 197</a>	<b>SubIndex</b>	DO Diagnosis Ch.04	RO	0x04 (4 <sub>dec</sub> )
	6032:01	Overcurrent	RO	0x00 (0 <sub>dec</sub> )
	6032:02	Overload	RO	0x00 (0 <sub>dec</sub> )
	6032:03	Open load	RO	0x00 (0 <sub>dec</sub> )
	6032:04	Short to 24V	RO	0x00 (0 <sub>dec</sub> )
6042:0 <a href="#">▶ 197</a>	<b>SubIndex</b>	DO Diagnosis Ch.05	RO	0x04 (4 <sub>dec</sub> )
	6042:01	Overcurrent	RO	0x00 (0 <sub>dec</sub> )
	6042:02	Overload	RO	0x00 (0 <sub>dec</sub> )
	6042:03	Open load	RO	0x00 (0 <sub>dec</sub> )
	6042:04	Short to 24V	RO	0x00 (0 <sub>dec</sub> )
6052:0 <a href="#">▶ 197</a>	<b>SubIndex</b>	DO Diagnosis Ch.06	RO	0x04 (4 <sub>dec</sub> )
	6052:01	Overcurrent	RO	0x00 (0 <sub>dec</sub> )
	6052:02	Overload	RO	0x00 (0 <sub>dec</sub> )
	6052:03	Open load	RO	0x00 (0 <sub>dec</sub> )
	6052:04	Short to 24V	RO	0x00 (0 <sub>dec</sub> )

Index		Name	Flags	Default value
6062:0 <a href="#">▶ 198</a>	<b>SubIndex</b>	DO Diagnosis Ch.07	RO	0x04 (4 <sub>dec</sub> )
	6062:01	Overcurrent	RO	0x00 (0 <sub>dec</sub> )
	6062:02	Overload	RO	0x00 (0 <sub>dec</sub> )
	6062:03	Open load	RO	0x00 (0 <sub>dec</sub> )
	6062:04	Short to 24V	RO	0x00 (0 <sub>dec</sub> )
6072:0 <a href="#">▶ 198</a>	<b>SubIndex</b>	DO Diagnosis Ch.08	RO	0x04 (4 <sub>dec</sub> )
	6072:01	Overcurrent	RO	0x00 (0 <sub>dec</sub> )
	6072:02	Overload	RO	0x00 (0 <sub>dec</sub> )
	6072:03	Open load	RO	0x00 (0 <sub>dec</sub> )
	6072:04	Short to 24V	RO	0x00 (0 <sub>dec</sub> )
6082:0 <a href="#">▶ 198</a>	<b>SubIndex</b>	DO Diagnosis Ch.09	RO	0x04 (4 <sub>dec</sub> )
	6082:01	Overcurrent	RO	0x00 (0 <sub>dec</sub> )
	6082:02	Overload	RO	0x00 (0 <sub>dec</sub> )
	6082:03	Open load	RO	0x00 (0 <sub>dec</sub> )
	6082:04	Short to 24V	RO	0x00 (0 <sub>dec</sub> )
6092:0 <a href="#">▶ 198</a>	<b>SubIndex</b>	DO Diagnosis Ch.10	RO	0x04 (4 <sub>dec</sub> )
	6092:01	Overcurrent	RO	0x00 (0 <sub>dec</sub> )
	6092:02	Overload	RO	0x00 (0 <sub>dec</sub> )
	6092:03	Open load	RO	0x00 (0 <sub>dec</sub> )
	6092:04	Short to 24V	RO	0x00 (0 <sub>dec</sub> )
60A2:0 <a href="#">▶ 198</a>	<b>SubIndex</b>	DO Diagnosis Ch.11	RO	0x04 (4 <sub>dec</sub> )
	60A2:01	Overcurrent	RO	0x00 (0 <sub>dec</sub> )
	60A2:02	Overload	RO	0x00 (0 <sub>dec</sub> )
	60A2:03	Open load	RO	0x00 (0 <sub>dec</sub> )
	60A2:04	Short to 24V	RO	0x00 (0 <sub>dec</sub> )
60B2:0 <a href="#">▶ 198</a>	<b>SubIndex</b>	DO Diagnosis Ch.12	RO	0x04 (4 <sub>dec</sub> )
	60B2:01	Overcurrent	RO	0x00 (0 <sub>dec</sub> )
	60B2:02	Overload	RO	0x00 (0 <sub>dec</sub> )
	60B2:03	Open load	RO	0x00 (0 <sub>dec</sub> )
	60B2:04	Short to 24V	RO	0x00 (0 <sub>dec</sub> )
60C2:0 <a href="#">▶ 199</a>	<b>SubIndex</b>	DO Diagnosis Ch.13	RO	0x04 (4 <sub>dec</sub> )
	60C2:01	Overcurrent	RO	0x00 (0 <sub>dec</sub> )
	60C2:02	Overload	RO	0x00 (0 <sub>dec</sub> )
	60C2:03	Open load	RO	0x00 (0 <sub>dec</sub> )
	60C2:04	Short to 24V	RO	0x00 (0 <sub>dec</sub> )
60D2:0 <a href="#">▶ 199</a>	<b>SubIndex</b>	DO Diagnosis Ch.14	RO	0x04 (4 <sub>dec</sub> )
	60D2:01	Overcurrent	RO	0x00 (0 <sub>dec</sub> )
	60D2:02	Overload	RO	0x00 (0 <sub>dec</sub> )
	60D2:03	Open load	RO	0x00 (0 <sub>dec</sub> )
	60D2:04	Short to 24V	RO	0x00 (0 <sub>dec</sub> )
60E2:0 <a href="#">▶ 199</a>	<b>SubIndex</b>	DO Diagnosis Ch.15	RO	0x04 (4 <sub>dec</sub> )
	60E2:01	Overcurrent	RO	0x00 (0 <sub>dec</sub> )
	60E2:02	Overload	RO	0x00 (0 <sub>dec</sub> )
	60E2:03	Open load	RO	0x00 (0 <sub>dec</sub> )
	60E2:04	Short to 24V	RO	0x00 (0 <sub>dec</sub> )
60F2:0 <a href="#">▶ 199</a>	<b>SubIndex</b>	DO Diagnosis Ch.16	RO	0x04 (4 <sub>dec</sub> )
	60F2:01	Overcurrent	RO	0x00 (0 <sub>dec</sub> )
	60F2:02	Overload	RO	0x00 (0 <sub>dec</sub> )
	60F2:03	Open load	RO	0x00 (0 <sub>dec</sub> )
	60F2:04	Short to 24V	RO	0x00 (0 <sub>dec</sub> )
7000:0 <a href="#">▶ 199</a>	<b>SubIndex</b>	DO Output Ch.01	RO	0x01 (1 <sub>dec</sub> )
	7000:01	Output	RO	0x00 (0 <sub>dec</sub> )
7010:0 <a href="#">▶ 199</a>	<b>SubIndex</b>	DO Output Ch.02	RO	0x01 (1 <sub>dec</sub> )
	7010:01	Output	RO	0x00 (0 <sub>dec</sub> )
7020:0 <a href="#">▶ 199</a>	<b>SubIndex</b>	DO Output Ch.03	RO	0x01 (1 <sub>dec</sub> )
	7020:01	Output	RO	0x00 (0 <sub>dec</sub> )
7030:0 <a href="#">▶ 200</a>	<b>SubIndex</b>	DO Output Ch.04	RO	0x01 (1 <sub>dec</sub> )
	7030:01	Output	RO	0x00 (0 <sub>dec</sub> )

Index		Name	Flags	Default value
7040:0 <a href="#">▶ 2001</a>	<b>SubIndex</b>	DO Output Ch.05	RO	0x01 (1 <sub>dec</sub> )
	7040:01	Output	RO	0x00 (0 <sub>dec</sub> )
7050:0 <a href="#">▶ 2001</a>	<b>SubIndex</b>	DO Output Ch.06	RO	0x01 (1 <sub>dec</sub> )
	7050:01	Output	RO	0x00 (0 <sub>dec</sub> )
7060:0 <a href="#">▶ 2001</a>	<b>SubIndex</b>	DO Output Ch.07	RO	0x01 (1 <sub>dec</sub> )
	7060:01	Output	RO	0x00 (0 <sub>dec</sub> )
7070:0 <a href="#">▶ 2001</a>	<b>SubIndex</b>	DO Output Ch.08	RO	0x01 (1 <sub>dec</sub> )
	7070:01	Output	RO	0x00 (0 <sub>dec</sub> )
7080:0 <a href="#">▶ 2001</a>	<b>SubIndex</b>	DO Output Ch.09	RO	0x01 (1 <sub>dec</sub> )
	7080:01	Output	RO	0x00 (0 <sub>dec</sub> )
7090:0 <a href="#">▶ 2001</a>	<b>SubIndex</b>	DO Output Ch.10	RO	0x01 (1 <sub>dec</sub> )
	7090:01	Output	RO	0x00 (0 <sub>dec</sub> )
70A0:0 <a href="#">▶ 2001</a>	<b>SubIndex</b>	DO Output Ch.11	RO	0x01 (1 <sub>dec</sub> )
	70A0:01	Output	RO	0x00 (0 <sub>dec</sub> )
70B0:0 <a href="#">▶ 2001</a>	<b>SubIndex</b>	DO Output Ch.12	RO	0x01 (1 <sub>dec</sub> )
	70B0:01	Output	RO	0x00 (0 <sub>dec</sub> )
70C0:0 <a href="#">▶ 2011</a>	<b>SubIndex</b>	DO Output Ch.13	RO	0x01 (1 <sub>dec</sub> )
	70C0:01	Output	RO	0x00 (0 <sub>dec</sub> )
70D0:0 <a href="#">▶ 2011</a>	<b>SubIndex</b>	DO Output Ch.14	RO	0x01 (1 <sub>dec</sub> )
	70D0:01	Output	RO	0x00 (0 <sub>dec</sub> )
70E0:0 <a href="#">▶ 2011</a>	<b>SubIndex</b>	DO Output Ch.15	RO	0x01 (1 <sub>dec</sub> )
	70E0:01	Output	RO	0x00 (0 <sub>dec</sub> )
70F0:0 <a href="#">▶ 2011</a>	<b>SubIndex</b>	DO Output Ch.16	RO	0x01 (1 <sub>dec</sub> )
	70F0:01	Output	RO	0x00 (0 <sub>dec</sub> )
8000:0 <a href="#">▶ 2011</a>	<b>SubIndex</b>	DO Settings Ch.01	RW	0x05 (5 <sub>dec</sub> )
	8000:01	Detect open wire in off state	RW	0x00 (0 <sub>dec</sub> )
	8000:02	Detect open wire in on state	RW	0x00 (0 <sub>dec</sub> )
	8000:03	Detect short to 24V	RW	0x00 (0 <sub>dec</sub> )
	8000:04	Safe state active	RW	0x01 (1 <sub>dec</sub> )
	8000:05	Safe state value	RW	0x00 (0 <sub>dec</sub> )
8010:0 <a href="#">▶ 2021</a>	<b>SubIndex</b>	DO Settings Ch.02	RW	0x05 (5 <sub>dec</sub> )
	8010:01	Detect open wire in off state	RW	0x00 (0 <sub>dec</sub> )
	8010:02	Detect open wire in on state	RW	0x00 (0 <sub>dec</sub> )
	8010:03	Detect short to 24V	RW	0x00 (0 <sub>dec</sub> )
	8010:04	Safe state active	RW	0x01 (1 <sub>dec</sub> )
	8010:05	Safe state value	RW	0x00 (0 <sub>dec</sub> )
8020:0 <a href="#">▶ 2021</a>	<b>SubIndex</b>	DO Settings Ch.03	RW	0x05 (5 <sub>dec</sub> )
	8020:01	Detect open wire in off state	RW	0x00 (0 <sub>dec</sub> )
	8020:02	Detect open wire in on state	RW	0x00 (0 <sub>dec</sub> )
	8020:03	Detect short to 24V	RW	0x00 (0 <sub>dec</sub> )
	8020:04	Safe state active	RW	0x01 (1 <sub>dec</sub> )
	8020:05	Safe state value	RW	0x00 (0 <sub>dec</sub> )
8030:0 <a href="#">▶ 2021</a>	<b>SubIndex</b>	DO Settings Ch.04	RW	0x05 (5 <sub>dec</sub> )
	8030:01	Detect open wire in off state	RW	0x00 (0 <sub>dec</sub> )
	8030:02	Detect open wire in on state	RW	0x00 (0 <sub>dec</sub> )
	8030:03	Detect short to 24V	RW	0x00 (0 <sub>dec</sub> )
	8030:04	Safe state active	RW	0x01 (1 <sub>dec</sub> )
	8030:05	Safe state value	RW	0x00 (0 <sub>dec</sub> )
8040:0 <a href="#">▶ 2031</a>	<b>SubIndex</b>	DO Settings Ch.05	RW	0x05 (5 <sub>dec</sub> )
	8040:01	Detect open wire in off state	RW	0x00 (0 <sub>dec</sub> )
	8040:02	Detect open wire in on state	RW	0x00 (0 <sub>dec</sub> )
	8040:03	Detect short to 24V	RW	0x00 (0 <sub>dec</sub> )
	8040:04	Safe state active	RW	0x01 (1 <sub>dec</sub> )
	8040:05	Safe state value	RW	0x00 (0 <sub>dec</sub> )

Index		Name	Flags	Default value
8050:0 [▶ 203]	<b>SubIndex</b>	DO Settings Ch.06	RW	0x05 (5 <sub>dec</sub> )
	8050:01	Detect open wire in off state	RW	0x00 (0 <sub>dec</sub> )
	8050:02	Detect open wire in on state	RW	0x00 (0 <sub>dec</sub> )
	8050:03	Detect short to 24V	RW	0x00 (0 <sub>dec</sub> )
	8050:04	Safe state active	RW	0x01 (1 <sub>dec</sub> )
	8050:05	Safe state value	RW	0x00 (0 <sub>dec</sub> )
8060:0 [▶ 203]	<b>SubIndex</b>	DO Settings Ch.07	RW	0x05 (5 <sub>dec</sub> )
	8060:01	Detect open wire in off state	RW	0x00 (0 <sub>dec</sub> )
	8060:02	Detect open wire in on state	RW	0x00 (0 <sub>dec</sub> )
	8060:03	Detect short to 24V	RW	0x00 (0 <sub>dec</sub> )
	8060:04	Safe state active	RW	0x01 (1 <sub>dec</sub> )
	8060:05	Safe state value	RW	0x00 (0 <sub>dec</sub> )
8070:0 [▶ 204]	<b>SubIndex</b>	DO Settings Ch.08	RW	0x05 (5 <sub>dec</sub> )
	8070:01	Detect open wire in off state	RW	0x00 (0 <sub>dec</sub> )
	8070:02	Detect open wire in on state	RW	0x00 (0 <sub>dec</sub> )
	8070:03	Detect short to 24V	RW	0x00 (0 <sub>dec</sub> )
	8070:04	Safe state active	RW	0x01 (1 <sub>dec</sub> )
	8070:05	Safe state value	RW	0x00 (0 <sub>dec</sub> )
8080:0 [▶ 204]	<b>SubIndex</b>	DO Settings Ch.09	RW	0x05 (5 <sub>dec</sub> )
	8080:01	Detect open wire in off state	RW	0x00 (0 <sub>dec</sub> )
	8080:02	Detect open wire in on state	RW	0x00 (0 <sub>dec</sub> )
	8080:03	Detect short to 24V	RW	0x00 (0 <sub>dec</sub> )
	8080:04	Safe state active	RW	0x01 (1 <sub>dec</sub> )
	8080:05	Safe state value	RW	0x00 (0 <sub>dec</sub> )
8090:0 [▶ 204]	<b>SubIndex</b>	DO Settings Ch.10	RW	0x05 (5 <sub>dec</sub> )
	8090:01	Detect open wire in off state	RW	0x00 (0 <sub>dec</sub> )
	8090:02	Detect open wire in on state	RW	0x00 (0 <sub>dec</sub> )
	8090:03	Detect short to 24V	RW	0x00 (0 <sub>dec</sub> )
	8090:04	Safe state active	RW	0x01 (1 <sub>dec</sub> )
	8090:05	Safe state value	RW	0x00 (0 <sub>dec</sub> )
80A0:0 [▶ 205]	<b>SubIndex</b>	DO Settings Ch.11	RW	0x05 (5 <sub>dec</sub> )
	80A0:01	Detect open wire in off state	RW	0x00 (0 <sub>dec</sub> )
	80A0:02	Detect open wire in on state	RW	0x00 (0 <sub>dec</sub> )
	80A0:03	Detect short to 24V	RW	0x00 (0 <sub>dec</sub> )
	80A0:04	Safe state active	RW	0x01 (1 <sub>dec</sub> )
	80A0:05	Safe state value	RW	0x00 (0 <sub>dec</sub> )
80B0:0 [▶ 205]	<b>SubIndex</b>	DO Settings Ch.12	RW	0x05 (5 <sub>dec</sub> )
	80B0:01	Detect open wire in off state	RW	0x00 (0 <sub>dec</sub> )
	80B0:02	Detect open wire in on state	RW	0x00 (0 <sub>dec</sub> )
	80B0:03	Detect short to 24V	RW	0x00 (0 <sub>dec</sub> )
	80B0:04	Safe state active	RW	0x01 (1 <sub>dec</sub> )
	80B0:05	Safe state value	RW	0x00 (0 <sub>dec</sub> )
80C0:0 [▶ 205]	<b>SubIndex</b>	DO Settings Ch.13	RW	0x05 (5 <sub>dec</sub> )
	80C0:01	Detect open wire in off state	RW	0x00 (0 <sub>dec</sub> )
	80C0:02	Detect open wire in on state	RW	0x00 (0 <sub>dec</sub> )
	80C0:03	Detect short to 24V	RW	0x00 (0 <sub>dec</sub> )
	80C0:04	Safe state active	RW	0x01 (1 <sub>dec</sub> )
	80C0:05	Safe state value	RW	0x00 (0 <sub>dec</sub> )
80D0:0 [▶ 206]	<b>SubIndex</b>	DO Settings Ch.14	RW	0x05 (5 <sub>dec</sub> )
	80D0:01	Detect open wire in off state	RW	0x00 (0 <sub>dec</sub> )
	80D0:02	Detect open wire in on state	RW	0x00 (0 <sub>dec</sub> )
	80D0:03	Detect short to 24V	RW	0x00 (0 <sub>dec</sub> )
	80D0:04	Safe state active	RW	0x01 (1 <sub>dec</sub> )
	80D0:05	Safe state value	RW	0x00 (0 <sub>dec</sub> )

Index		Name	Flags	Default value
80E0:0 [▶ 206]	<b>SubIndex</b>	DO Settings Ch.15	RW	0x05 (5 <sub>dec</sub> )
	80E0:01	Detect open wire in off state	RW	0x00 (0 <sub>dec</sub> )
	80E0:02	Detect open wire in on state	RW	0x00 (0 <sub>dec</sub> )
	80E0:03	Detect short to 24V	RW	0x00 (0 <sub>dec</sub> )
	80E0:04	Safe state active	RW	0x01 (1 <sub>dec</sub> )
	80E0:05	Safe state value	RW	0x00 (0 <sub>dec</sub> )
80F0:0 [▶ 206]	<b>SubIndex</b>	DO Settings Ch.16	RW	0x05 (5 <sub>dec</sub> )
	80F0:01	Detect open wire in off state	RW	0x00 (0 <sub>dec</sub> )
	80F0:02	Detect open wire in on state	RW	0x00 (0 <sub>dec</sub> )
	80F0:03	Detect short to 24V	RW	0x00 (0 <sub>dec</sub> )
	80F0:04	Safe state active	RW	0x01 (1 <sub>dec</sub> )
	80F0:05	Safe state value	RW	0x00 (0 <sub>dec</sub> )
F000:0 [▶ 207]	<b>SubIndex</b>	Modular Device Profile	RO	0x02 (2 <sub>dec</sub> )
	F000:01	Index distance	RO	0x0010 (16 <sub>dec</sub> )
	F000:02	Maximum number of modules	RO	0x0010 (16 <sub>dec</sub> )
F008 [▶ 207]		Code word	RW	0x00000000 (0 <sub>dec</sub> )
F600:0 [▶ 207]	<b>SubIndex</b>	DEV Inputs	RO	0x17 (23 <sub>dec</sub> )
	F600:01	Undervoltage Us	RO	0x00 (0 <sub>dec</sub> )
	F600:02	Undervoltage Up	RO	0x00 (0 <sub>dec</sub> )
	F600:03	Overtemperature	RO	0x00 (0 <sub>dec</sub> )
	F600:0D	Diag	RO	0x00 (0 <sub>dec</sub> )
	F600:0E	TxPDO State	RO	0x00 (0 <sub>dec</sub> )
	F600:0F	Input cycle counter	RO	0x00 (0 <sub>dec</sub> )
	F600:16	Voltage Us	RO	0x00000000 (0 <sub>dec</sub> )
	F600:17	Voltage Up	RO	0x00000000 (0 <sub>dec</sub> )
F800:0 [▶ 207]	<b>SubIndex</b>	DEV Settings	RW	0x12 (18 <sub>dec</sub> )
	F800:10	Us undervoltage detection threshold	RW	0x47E0 (18400 <sub>dec</sub> )
	F800:12	Up undervoltage detection threshold	RW	0x47E0 (18400 <sub>dec</sub> )
F80F:0 [▶ 207]	<b>SubIndex</b>	DEV Vendor data	RW	0x04 (4 <sub>dec</sub> )
	F80F:01	Offset Us	RW	0x00000000 (0 <sub>dec</sub> )
	F80F:02	Gain Us	RW	0x3F800000 (1065353216 <sub>dec</sub> )
	F80F:03	Offset Up	RW	0x00000000 (0 <sub>dec</sub> )
	F80F:04	Gain Up	RW	0x3F800000 (1065353216 <sub>dec</sub> )
F900:0 [▶ 207]	<b>SubIndex</b>	DEV Info data	RO	0x05 (5 <sub>dec</sub> )
	F900:02	Internal Temperature	RO	0x00 (0 <sub>dec</sub> )
	F900:04	Voltage Us	RO	0x0000 (0 <sub>dec</sub> )
	F900:05	Voltage Up	RO	0x0000 (0 <sub>dec</sub> )
FB00:0 [▶ 208]	<b>SubIndex</b>	DEV Command	RO	0x03 (3 <sub>dec</sub> )
	FB00:01	Request	RW	{0}
	FB00:02	Status	RO	0x00 (0 <sub>dec</sub> )
	FB00:03	Response	RO	{0}

## 7.4.2 Object description and parameterization

### Index 1000 Device type

Index (hex)	Name	Meaning	Data type	Flags	Default
1000:0	Device type	Device type of the EtherCAT slave: the Lo-Word contains the used CoE profile (5001). The Hi-Word contains the module profile according to the modular device profile.	UINT32	RO	0x00C81389 (13112201 <sub>dec</sub> )

### Index 1008 Device name

Index (hex)	Name	Meaning	Data type	Flags	Default
1008:0	Device name	Device name of the EtherCAT slave	STRING	RO	EP2839-0022 or EP2839-0042

### Index 1009 Hardware version

Index (hex)	Name	Meaning	Data type	Flags	Default
1009:0	Hardware version	Hardware version of the EtherCAT slave	STRING	RO	

### Index 100A Software version

Index (hex)	Name	Meaning	Data type	Flags	Default
100A:0	Software version	Firmware version of the EtherCAT slave	STRING	RO	00

### Index 100B Bootloader version

Index (hex)	Name	Meaning	Data type	Flags	Default
100B:0	Bootloader version		STRING	RO	N/A

### Index 1011 Restore default parameters

Index (hex)	Name	Meaning	Data type	Flags	Default
1011:0	Restore default parameters	Restore default settings	UINT8	RO	0x01 (1 <sub>dec</sub> )
1011:01	SubIndex 001	If this object is set to "0x64616F6C" in the set value dialog, all backup objects are reset to their delivery state.	UINT32	RW	0x00000000 (0 <sub>dec</sub> )

### Index 1018 Identity

Index (hex)	Name	Meaning	Data type	Flags	Default
1018:0	Identity	Information for identifying the slave	UINT8	RO	0x04 (4 <sub>dec</sub> )
1018:01	Vendor ID	Vendor ID of the EtherCAT slave	UINT32	RO	0x00000002 (2 <sub>dec</sub> )
1018:02	Product code	Product code of the EtherCAT slave	UINT32	RO	0x0B174052 (186073170 <sub>dec</sub> )
1018:03	Revision	Revision number of the EtherCAT slave; the Low Word (bit 0-15) indicates the special terminal number, the High Word (bit 16-31) refers to the device description	UINT32	RO	0x00000000 (0 <sub>dec</sub> )
1018:04	Serial number	Serial number of the EtherCAT slave; the Low Byte (bit 0-7) of the Low Word contains the year of production, the High Byte (bit 8-15) of the Low Word contains the week of production, the High Word (bit 16-31) is 0	UINT32	RO	0x00000000 (0 <sub>dec</sub> )

**Index 10E2 Manufacturer-specific Identification Code**

Index (hex)	Name	Meaning	Data type	Flags	Default
10E2:0	Manufacturer-specific Identification Code		UINT8	RO	0x01 (1 <sub>dec</sub> )
10E2:01	SubIndex 001		STRING	RO	

**Index 10F0 Backup parameter handling**

Index (hex)	Name	Meaning	Data type	Flags	Default
10F0:0	Backup parameter handling	Information for standardized loading and saving of backup entries	UINT8	RO	0x01 (1 <sub>dec</sub> )
10F0:01	Checksum	Checksum across all backup entries of the EtherCAT slave	UINT32	RO	0x00000000 (0 <sub>dec</sub> )

**Index 10F3 Diagnosis History**

Index (hex)	Name	Meaning	Data type	Flags	Default
10F3:0	Diagnosis History	Maximum subindex	UINT8	RO	0x15 (21 <sub>dec</sub> )
10F3:01	Maximum Messages	Maximum number of stored messages A maximum of 16 messages can be stored	UINT8	RO	0x00 (0 <sub>dec</sub> )
10F3:02	Newest Message	Subindex of the latest message	UINT8	RO	0x00 (0 <sub>dec</sub> )
10F3:03	Newest Acknowledged Message	Subindex of the last confirmed message	UINT8	RW	0x00 (0 <sub>dec</sub> )
10F3:04	New Messages Available	Indicates that a new message is available	BOOLEAN	RO	0x00 (0 <sub>dec</sub> )
10F3:05	Flags	not used	UINT16	RW	0x0000 (0 <sub>dec</sub> )
10F3:06	Diagnosis Message 001	Message 1	OCTET-STRING[20]	RO	{0}
...	...	..	...	...	...
10F3:15	Diagnosis Message 016	Message 16	OCTET-STRING[20]	RO	{0}

**Index 10F8 Timestamp Object**

Index (hex)	Name	Meaning	Data type	Flags	Default
10F8:0	Timestamp Object		UINT64	RO	

**Index 10F9 Time Distribution Object**

Index (hex)	Name	Meaning	Data type	Flags	Default
10F9:0	Time Distribution Object		UINT8	RO	0x01 (1 <sub>dec</sub> )
10F9:01	Distributed Time Value		UINT64	RW	

## Index 1600 DO RxPDO-Map Output

Index (hex)	Name	Meaning	Data type	Flags	Default
1600:0	DO RxPDO-Map Output	PDO Mapping RxPDO 1	UINT8	RO	0x10 (16 <sub>dec</sub> )
1600:01	SubIndex 001	1. PDO Mapping entry (object 0x7000 (DO Output Ch.01), entry 0x01 (Output))	UINT32	RO	0x7000:01, 1
1600:02	SubIndex 002	2. PDO Mapping entry (object 0x7010 (DO Output Ch.02), entry 0x01 (Output))	UINT32	RO	0x7010:01, 1
1600:03	SubIndex 003	3. PDO Mapping entry (object 0x7020 (DO Output Ch.03), entry 0x01 (Output))	UINT32	RO	0x7020:01, 1
1600:04	SubIndex 004	4. PDO Mapping entry (object 0x7030 (DO Output Ch.04), entry 0x01 (Output))	UINT32	RO	0x7030:01, 1
1600:05	SubIndex 005	5. PDO Mapping entry (object 0x7040 (DO Output Ch.05), entry 0x01 (Output))	UINT32	RO	0x7040:01, 1
1600:06	SubIndex 006	6. PDO Mapping entry (object 0x7050 (DO Output Ch.06), entry 0x01 (Output))	UINT32	RO	0x7050:01, 1
1600:07	SubIndex 007	7. PDO Mapping entry (object 0x7060 (DO Output Ch.07), entry 0x01 (Output))	UINT32	RO	0x7060:01, 1
1600:08	SubIndex 008	8. PDO Mapping entry (object 0x7070 (DO Output Ch.08), entry 0x01 (Output))	UINT32	RO	0x7070:01, 1
1600:09	SubIndex 009	9. PDO Mapping entry (object 0x7080 (DO Output Ch.09), entry 0x01 (Output))	UINT32	RO	0x7080:01, 1
1600:0A	SubIndex 010	10. PDO Mapping entry (object 0x7090 (DO Output Ch.10), entry 0x01 (Output))	UINT32	RO	0x7090:01, 1
1600:0B	SubIndex 011	11. PDO Mapping entry (object 0x70A0 (DO Output Ch.11), entry 0x01 (Output))	UINT32	RO	0x70A0:01, 1
1600:0C	SubIndex 012	12. PDO Mapping entry (object 0x70B0 (DO Output Ch.12), entry 0x01 (Output))	UINT32	RO	0x70B0:01, 1
1600:0D	SubIndex 013	13. PDO Mapping entry (object 0x70C0 (DO Output Ch.13), entry 0x01 (Output))	UINT32	RO	0x70C0:01, 1
1600:0E	SubIndex 014	14. PDO Mapping entry (object 0x70D0 (DO Output Ch.14), entry 0x01 (Output))	UINT32	RO	0x70D0:01, 1
1600:0F	SubIndex 015	15. PDO Mapping entry (object 0x70E0 (DO Output Ch.15), entry 0x01 (Output))	UINT32	RO	0x70E0:01, 1
1600:10	SubIndex 016	16. PDO Mapping entry (object 0x70F0 (DO Output Ch.16), entry 0x01 (Output))	UINT32	RO	0x70F0:01, 1



**Index 1A00 DO TxPDO-Map Diagnosis**

Index (hex)	Name	Meaning	Data type	Flags	Default
1A00:0	DO TxPDO-Map Diagnosis	PDO Mapping TxPDO 1	UINT8	RO	0x40 (64 <sub>dec</sub> )
1A00:01	SubIndex 001	1. PDO Mapping entry (object 0x6002 (DO Diagnosis Ch.01), entry 0x01 (Overcurrent))	UINT32	RO	0x6002:01, 1
1A00:02	SubIndex 002	2. PDO Mapping entry (object 0x6002 (DO Diagnosis Ch.01), entry 0x02 (Overload))	UINT32	RO	0x6002:02, 1
1A00:03	SubIndex 003	3. PDO Mapping entry (object 0x6002 (DO Diagnosis Ch.01), entry 0x03 (Open load))	UINT32	RO	0x6002:03, 1
1A00:04	SubIndex 004	4. PDO Mapping entry (object 0x6002 (DO Diagnosis Ch.01), entry 0x04 (Short to 24V))	UINT32	RO	0x6002:04, 1
1A00:05	SubIndex 005	5. PDO Mapping entry (object 0x6012 (DO Diagnosis Ch.02), entry 0x01 (Overcurrent))	UINT32	RO	0x6012:01, 1
1A00:06	SubIndex 006	6. PDO Mapping entry (object 0x6012 (DO Diagnosis Ch.02), entry 0x02 (Overload))	UINT32	RO	0x6012:02, 1
1A00:07	SubIndex 007	7. PDO Mapping entry (object 0x6012 (DO Diagnosis Ch.02), entry 0x03 (Open load))	UINT32	RO	0x6012:03, 1
1A00:08	SubIndex 008	8. PDO Mapping entry (object 0x6012 (DO Diagnosis Ch.02), entry 0x04 (Short to 24V))	UINT32	RO	0x6012:04, 1
1A00:09	SubIndex 009	9. PDO Mapping entry (object 0x6022 (DO Diagnosis Ch.03), entry 0x01 (Overcurrent))	UINT32	RO	0x6022:01, 1
1A00:0A	SubIndex 010	10. PDO Mapping entry (object 0x6022 (DO Diagnosis Ch.03), entry 0x02 (Overload))	UINT32	RO	0x6022:02, 1
1A00:0B	SubIndex 011	11. PDO Mapping entry (object 0x6022 (DO Diagnosis Ch.03), entry 0x03 (Open load))	UINT32	RO	0x6022:03, 1
1A00:0C	SubIndex 012	12. PDO Mapping entry (object 0x6022 (DO Diagnosis Ch.03), entry 0x04 (Short to 24V))	UINT32	RO	0x6022:04, 1
1A00:0D	SubIndex 013	13. PDO Mapping entry (object 0x6032 (DO Diagnosis Ch.04), entry 0x01 (Overcurrent))	UINT32	RO	0x6032:01, 1
1A00:0E	SubIndex 014	14. PDO Mapping entry (object 0x6032 (DO Diagnosis Ch.04), entry 0x02 (Overload))	UINT32	RO	0x6032:02, 1
1A00:0F	SubIndex 015	15. PDO Mapping entry (object 0x6032 (DO Diagnosis Ch.04), entry 0x03 (Open load))	UINT32	RO	0x6032:03, 1
1A00:10	SubIndex 016	16. PDO Mapping entry (object 0x6032 (DO Diagnosis Ch.04), entry 0x04 (Short to 24V))	UINT32	RO	0x6032:04, 1
1A00:11	SubIndex 017	17. PDO Mapping entry (object 0x6042 (DO Diagnosis Ch.05), entry 0x01 (Overcurrent))	UINT32	RO	0x6042:01, 1
1A00:12	SubIndex 018	18. PDO Mapping entry (object 0x6042 (DO Diagnosis Ch.05), entry 0x02 (Overload))	UINT32	RO	0x6042:02, 1
1A00:13	SubIndex 019	19. PDO Mapping entry (object 0x6042 (DO Diagnosis Ch.05), entry 0x03 (Open load))	UINT32	RO	0x6042:03, 1
1A00:14	SubIndex 020	20. PDO Mapping entry (object 0x6042 (DO Diagnosis Ch.05), entry 0x04 (Short to 24V))	UINT32	RO	0x6042:04, 1
1A00:15	SubIndex 021	21. PDO Mapping entry (object 0x6052 (DO Diagnosis Ch.06), entry 0x01 (Overcurrent))	UINT32	RO	0x6052:01, 1
1A00:16	SubIndex 022	22. PDO Mapping entry (object 0x6052 (DO Diagnosis Ch.06), entry 0x02 (Overload))	UINT32	RO	0x6052:02, 1
1A00:17	SubIndex 023	23. PDO Mapping entry (object 0x6052 (DO Diagnosis Ch.06), entry 0x03 (Open load))	UINT32	RO	0x6052:03, 1
1A00:18	SubIndex 024	24. PDO Mapping entry (object 0x6052 (DO Diagnosis Ch.06), entry 0x04 (Short to 24V))	UINT32	RO	0x6052:04, 1
1A00:19	SubIndex 025	25. PDO Mapping entry (object 0x6062 (DO Diagnosis Ch.07), entry 0x01 (Overcurrent))	UINT32	RO	0x6062:01, 1
1A00:1A	SubIndex 026	26. PDO Mapping entry (object 0x6062 (DO Diagnosis Ch.07), entry 0x02 (Overload))	UINT32	RO	0x6062:02, 1
1A00:1B	SubIndex 027	27. PDO Mapping entry (object 0x6062 (DO Diagnosis Ch.07), entry 0x03 (Open load))	UINT32	RO	0x6062:03, 1
1A00:1C	SubIndex 028	28. PDO Mapping entry (object 0x6062 (DO Diagnosis Ch.07), entry 0x04 (Short to 24V))	UINT32	RO	0x6062:04, 1
1A00:1D	SubIndex 029	29. PDO Mapping entry (object 0x6072 (DO Diagnosis Ch.08), entry 0x01 (Overcurrent))	UINT32	RO	0x6072:01, 1
1A00:1E	SubIndex 030	30. PDO Mapping entry (object 0x6072 (DO Diagnosis Ch.08), entry 0x02 (Overload))	UINT32	RO	0x6072:02, 1
1A00:1F	SubIndex 031	31. PDO Mapping entry (object 0x6072 (DO Diagnosis Ch.08), entry 0x03 (Open load))	UINT32	RO	0x6072:03, 1

Index (hex)	Name	Meaning	Data type	Flags	Default
1A00:20	SubIndex 032	32. PDO Mapping entry (object 0x6072 (DO Diagnosis Ch.08), entry 0x04 (Short to 24V))	UINT32	RO	0x6072:04, 1
1A00:21	SubIndex 033	33. PDO Mapping entry (object 0x6082 (DO Diagnosis Ch.09), entry 0x01 (Overcurrent))	UINT32	RO	0x6082:01, 1
1A00:22	SubIndex 034	34. PDO Mapping entry (object 0x6082 (DO Diagnosis Ch.09), entry 0x02 (Overload))	UINT32	RO	0x6082:02, 1
1A00:23	SubIndex 035	35. PDO Mapping entry (object 0x6082 (DO Diagnosis Ch.09), entry 0x03 (Open load))	UINT32	RO	0x6082:03, 1
1A00:24	SubIndex 036	36. PDO Mapping entry (object 0x6082 (DO Diagnosis Ch.09), entry 0x04 (Short to 24V))	UINT32	RO	0x6082:04, 1
1A00:25	SubIndex 037	37. PDO Mapping entry (object 0x6092 (DO Diagnosis Ch.10), entry 0x01 (Overcurrent))	UINT32	RO	0x6092:01, 1
1A00:26	SubIndex 038	38. PDO Mapping entry (object 0x6092 (DO Diagnosis Ch.10), entry 0x02 (Overload))	UINT32	RO	0x6092:02, 1
1A00:27	SubIndex 039	39. PDO Mapping entry (object 0x6092 (DO Diagnosis Ch.10), entry 0x03 (Open load))	UINT32	RO	0x6092:03, 1
1A00:28	SubIndex 040	40. PDO Mapping entry (object 0x6092 (DO Diagnosis Ch.10), entry 0x04 (Short to 24V))	UINT32	RO	0x6092:04, 1
1A00:29	SubIndex 041	41. PDO Mapping entry (object 0x60A2 (DO Diagnosis Ch.11), entry 0x01 (Overcurrent))	UINT32	RO	0x60A2:01, 1
1A00:2A	SubIndex 042	42. PDO Mapping entry (object 0x60A2 (DO Diagnosis Ch.11), entry 0x02 (Overload))	UINT32	RO	0x60A2:02, 1
1A00:2B	SubIndex 043	43. PDO Mapping entry (object 0x60A2 (DO Diagnosis Ch.11), entry 0x03 (Open load))	UINT32	RO	0x60A2:03, 1
1A00:2C	SubIndex 044	44. PDO Mapping entry (object 0x60A2 (DO Diagnosis Ch.11), entry 0x04 (Short to 24V))	UINT32	RO	0x60A2:04, 1
1A00:2D	SubIndex 045	45. PDO Mapping entry (object 0x60B2 (DO Diagnosis Ch.12), entry 0x01 (Overcurrent))	UINT32	RO	0x60B2:01, 1
1A00:2E	SubIndex 046	46. PDO Mapping entry (object 0x60B2 (DO Diagnosis Ch.12), entry 0x02 (Overload))	UINT32	RO	0x60B2:02, 1
1A00:2F	SubIndex 047	47. PDO Mapping entry (object 0x60B2 (DO Diagnosis Ch.12), entry 0x03 (Open load))	UINT32	RO	0x60B2:03, 1
1A00:30	SubIndex 048	48. PDO Mapping entry (object 0x60B2 (DO Diagnosis Ch.12), entry 0x04 (Short to 24V))	UINT32	RO	0x60B2:04, 1
1A00:31	SubIndex 049	49. PDO Mapping entry (object 0x60C2 (DO Diagnosis Ch.13), entry 0x01 (Overcurrent))	UINT32	RO	0x60C2:01, 1
1A00:32	SubIndex 050	50. PDO Mapping entry (object 0x60C2 (DO Diagnosis Ch.13), entry 0x02 (Overload))	UINT32	RO	0x60C2:02, 1
1A00:33	SubIndex 051	51. PDO Mapping entry (object 0x60C2 (DO Diagnosis Ch.13), entry 0x03 (Open load))	UINT32	RO	0x60C2:03, 1
1A00:34	SubIndex 052	52. PDO Mapping entry (object 0x60C2 (DO Diagnosis Ch.13), entry 0x04 (Short to 24V))	UINT32	RO	0x60C2:04, 1
1A00:35	SubIndex 053	53. PDO Mapping entry (object 0x60D2 (DO Diagnosis Ch.14), entry 0x01 (Overcurrent))	UINT32	RO	0x60D2:01, 1
1A00:36	SubIndex 054	54. PDO Mapping entry (object 0x60D2 (DO Diagnosis Ch.14), entry 0x02 (Overload))	UINT32	RO	0x60D2:02, 1
1A00:37	SubIndex 055	55. PDO Mapping entry (object 0x60D2 (DO Diagnosis Ch.14), entry 0x03 (Open load))	UINT32	RO	0x60D2:03, 1
1A00:38	SubIndex 056	56. PDO Mapping entry (object 0x60D2 (DO Diagnosis Ch.14), entry 0x04 (Short to 24V))	UINT32	RO	0x60D2:04, 1
1A00:39	SubIndex 057	57. PDO Mapping entry (object 0x60E2 (DO Diagnosis Ch.15), entry 0x01 (Overcurrent))	UINT32	RO	0x60E2:01, 1
1A00:3A	SubIndex 058	58. PDO Mapping entry (object 0x60E2 (DO Diagnosis Ch.15), entry 0x02 (Overload))	UINT32	RO	0x60E2:02, 1
1A00:3B	SubIndex 059	59. PDO Mapping entry (object 0x60E2 (DO Diagnosis Ch.15), entry 0x03 (Open load))	UINT32	RO	0x60E2:03, 1
1A00:3C	SubIndex 060	60. PDO Mapping entry (object 0x60E2 (DO Diagnosis Ch.15), entry 0x04 (Short to 24V))	UINT32	RO	0x60E2:04, 1
1A00:3D	SubIndex 061	61. PDO Mapping entry (object 0x60F2 (DO Diagnosis Ch.16), entry 0x01 (Overcurrent))	UINT32	RO	0x60F2:01, 1
1A00:3E	SubIndex 062	62. PDO Mapping entry (object 0x60F2 (DO Diagnosis Ch.16), entry 0x02 (Overload))	UINT32	RO	0x60F2:02, 1
1A00:3F	SubIndex 063	63. PDO Mapping entry (object 0x60F2 (DO Diagnosis Ch.16), entry 0x03 (Open load))	UINT32	RO	0x60F2:03, 1

Index (hex)	Name	Meaning	Data type	Flags	Default
1A00:40	SubIndex 064	64. PDO Mapping entry (object 0x60F2 (DO Diagnosis Ch.16), entry 0x04 (Short to 24V))	UINT32	RO	0x60F2:04, 1

**Index 1A01 DEV TxPDO-Map Inputs Device**

Index (hex)	Name	Meaning	Data type	Flags	Default
1A01:0	DEV TxPDO-Map Inputs Device	PDO Mapping TxPDO 2	UINT8	RO	0x07 (7 <sub>dec</sub> )
1A01:01	SubIndex 001	1. PDO Mapping entry (object 0xF600 (DEV Inputs), entry 0x01 (Undervoltage Us))	UINT32	RO	0xF600:01, 1
1A01:02	SubIndex 002	2. PDO Mapping entry (object 0xF600 (DEV Inputs), entry 0x02 (Undervoltage Up))	UINT32	RO	0xF600:02, 1
1A01:03	SubIndex 003	3. PDO Mapping entry (object 0xF600 (DEV Inputs), entry 0x03 (Overtemperature))	UINT32	RO	0xF600:03, 1
1A01:04	SubIndex 004	4. PDO Mapping entry (9 bits align)	UINT32	RO	0x0000:00, 9
1A01:05	SubIndex 005	5. PDO Mapping entry (object 0xF600 (DEV Inputs), entry 0x0D (Diag))	UINT32	RO	0xF600:0D, 1
1A01:06	SubIndex 006	6. PDO Mapping entry (object 0xF600 (DEV Inputs), entry 0x0E (TxPDO State))	UINT32	RO	0xF600:0E, 1
1A01:07	SubIndex 007	7. PDO Mapping entry (object 0xF600 (DEV Inputs), entry 0x0F (Input cycle counter))	UINT32	RO	0xF600:0F, 2

**Index 1A02 DEV TxPDO-Map Voltages**

Index (hex)	Name	Meaning	Data type	Flags	Default
1A02:0	DEV TxPDO Map Voltages	PDO Mapping TxPDO 3	UINT8	RO	0x02 (2 <sub>dec</sub> )
1A02:01	SubIndex 001	1. PDO Mapping entry (object 0xF600 (DEV Inputs), entry 0x16 (Voltage Us))	UINT32	RO	0xF600:16, 32
1A02:02	SubIndex 002	2. PDO Mapping entry (object 0xF600 (DEV Inputs), entry 0x17 (Voltage Up))	UINT32	RO	0xF600:17, 32

**Index 1C00 Sync manager type**

Index (hex)	Name	Meaning	Data type	Flags	Default
1C00:0	Sync manager type	Using the Sync Managers	UINT8	RO	0x04 (4 <sub>dec</sub> )
1C00:01	SubIndex 001	Sync-Manager Type Channel 1: Mailbox Write	UINT8	RO	0x01 (1 <sub>dec</sub> )
1C00:02	SubIndex 002	Sync-Manager Type Channel 2: Mailbox Read	UINT8	RO	0x02 (2 <sub>dec</sub> )
1C00:03	SubIndex 003	Sync-Manager Type Channel 3: Process Data Write (Outputs)	UINT8	RO	0x03 (3 <sub>dec</sub> )
1C00:04	SubIndex 004	Sync-Manager Type Channel 4: Process Data Read (Inputs)	UINT8	RO	0x04 (4 <sub>dec</sub> )

**Index 1C12 RxPDO assign**

Index (hex)	Name	Meaning	Data type	Flags	Default
1C12:0	RxPDO assign	PDO Assign Outputs	UINT8	RO	0x01 (1 <sub>dec</sub> )
1C12:01	Subindex 001	1. allocated RxPDO (contains the index of the associated RxPDO mapping object)	UINT16	RO	0x1600 (5632 <sub>dec</sub> )

**Index 1C13 TxPDO assign**

Index (hex)	Name	Meaning	Data type	Flags	Default
1C13:0	TxPDO assign	PDO Assign Inputs	UINT8	RW	0x01 (1 <sub>dec</sub> )
1C13:01	Subindex 001	1. allocated TxPDO (contains the index of the associated TxPDO mapping object)	UINT16	RW	0x1A01 (6657 <sub>dec</sub> )
1C13:02	Subindex 002	2. allocated TxPDO (contains the index of the associated TxPDO mapping object)	UINT16	RW	0x0000 (0 <sub>dec</sub> )
1C13:03	Subindex 003	3. allocated TxPDO (contains the index of the associated TxPDO mapping object)	UINT16	RW	0x0000 (0 <sub>dec</sub> )

## Index 1C32 SM output parameter

Index (hex)	Name	Meaning	Data type	Flags	Default
1C32:0	SM output parameter	Synchronization parameters for the outputs	UINT8	RO	0x20 (32 <sub>dec</sub> )
1C32:01	Sync mode	Current synchronization mode:	UINT16	RW	0x0001 (1 <sub>dec</sub> )
1C32:02	Cycle time	Cycle time (in ns):	UINT32	RW	0x000F4240 (1000000 <sub>dec</sub> )
1C32:03	Shift time	Time between SYNC0 event and output of the outputs (in ns, DC mode only)	UINT32	RO	0x00000000 (0 <sub>dec</sub> )
1C32:04	Sync modes supported	Supported synchronization modes:	UINT16	RO	0x440B (17419 <sub>dec</sub> )
1C32:05	Minimum cycle time	Minimum cycle time (in ns)	UINT32	RO	0x000186A0 (100000 <sub>dec</sub> )
1C32:06	Calc and copy time	Minimum time between SYNC0 and SYNC1 event (in ns, DC mode only)	UINT32	RO	0x00000000 (0 <sub>dec</sub> )
1C32:07	Minimum delay time		UINT32	RO	0x00000000 (0 <sub>dec</sub> )
1C32:08	Get Cycle Time		UINT16	RW	0x0000 (0 <sub>dec</sub> )
1C32:09	Maximum delay time	Time between SYNC1 event and output of the outputs (in ns, DC mode only)	UINT32	RO	0x00000000 (0 <sub>dec</sub> )
1C32:0B	SM event missed counter	Number of missed SM events in OPERATIONAL (DC mode only)	UINT16	RO	0x0000 (0 <sub>dec</sub> )
1C32:0C	Cycle exceeded counter	Number of occasions the cycle time was exceeded in OPERATIONAL (cycle was not completed in time or the next cycle began too early)	UINT16	RO	0x0000 (0 <sub>dec</sub> )
1C32:0D	Shift too short counter	Number of occasions that the interval between SYNC0 and SYNC1 event was too short (DC mode only)	UINT16	RO	0x0000 (0 <sub>dec</sub> )
1C32:20	Sync error	The synchronization was not correct in the last cycle (outputs were output too late; DC mode only)	BOOLEAN	RO	0x00 (0 <sub>dec</sub> )

## Index 1C33 SM input parameter

Index (hex)	Name	Meaning	Data type	Flags	Default
1C33:0	SM input parameter	Synchronization parameters for the inputs	UINT8	RO	0x20 (32 <sub>dec</sub> )
1C33:01	Sync mode	Current synchronization mode:	UINT16	RW	0x0022 (34 <sub>dec</sub> )
1C33:02	Cycle time	as 1C32:02	UINT32	RW	0x000F4240 (1000000 <sub>dec</sub> )
1C33:03	Shift time	Time between SYNC0 event and reading of the inputs (in ns, DC mode only)	UINT32	RO	0x000186A0 (100000 <sub>dec</sub> )
1C33:04	Sync modes supported	Supported synchronization modes:	UINT16	RO	0x440B (17419 <sub>dec</sub> )
1C33:05	Minimum cycle time	as 1C32:05	UINT32	RO	0x000186A0 (100000 <sub>dec</sub> )
1C33:06	Calc and copy time	Time between reading of the inputs and availability of the inputs for the master (in ns, only DC mode)	UINT32	RO	0x00000000 (0 <sub>dec</sub> )
1C33:07	Minimum delay time		UINT32	RO	0x00000000 (0 <sub>dec</sub> )
1C33:08	Get Cycle Time	as 1C32:08	UINT16	RW	0x0000 (0 <sub>dec</sub> )
1C33:09	Maximum delay time	Time between SYNC1 event and reading of the inputs (in ns, only DC mode)	UINT32	RO	0x00000000 (0 <sub>dec</sub> )
1C33:0B	SM event missed counter	as 1C32:11	UINT16	RO	0x0000 (0 <sub>dec</sub> )
1C33:0C	Cycle exceeded counter	as 1C32:12	UINT16	RO	0x0000 (0 <sub>dec</sub> )
1C33:0D	Shift too short counter	as 1C32:13	UINT16	RO	0x0000 (0 <sub>dec</sub> )
1C33:20	Sync error	as 1C32:32	BOOLEAN	RO	0x00 (0 <sub>dec</sub> )

**Index 6002 DO Diagnosis Ch.01**

Index (hex)	Name	Meaning	Data type	Flags	Default
6002:0	DO Diagnosis Ch.01	Diagnostic information	UINT8	RO	0x04 (4 <sub>dec</sub> )
6002:01	Overcurrent		BOOLEAN	RO	0x00 (0 <sub>dec</sub> )
6002:02	Overload		BOOLEAN	RO	0x00 (0 <sub>dec</sub> )
6002:03	Open load		BOOLEAN	RO	0x00 (0 <sub>dec</sub> )
6002:04	Short to 24V		BOOLEAN	RO	0x00 (0 <sub>dec</sub> )

**Index 6012 DO Diagnosis Ch.02**

Index (hex)	Name	Meaning	Data type	Flags	Default
6012:0	DO Diagnosis Ch.02	Diagnostic information	UINT8	RO	0x04 (4 <sub>dec</sub> )
6012:01	Overcurrent		BOOLEAN	RO	0x00 (0 <sub>dec</sub> )
6012:02	Overload		BOOLEAN	RO	0x00 (0 <sub>dec</sub> )
6012:03	Open load		BOOLEAN	RO	0x00 (0 <sub>dec</sub> )
6012:04	Short to 24V		BOOLEAN	RO	0x00 (0 <sub>dec</sub> )

**Index 6022 DO Diagnosis Ch.03**

Index (hex)	Name	Meaning	Data type	Flags	Default
6022:0	DO Diagnosis Ch.03	Diagnostic information	UINT8	RO	0x04 (4 <sub>dec</sub> )
6022:01	Overcurrent		BOOLEAN	RO	0x00 (0 <sub>dec</sub> )
6022:02	Overload		BOOLEAN	RO	0x00 (0 <sub>dec</sub> )
6022:03	Open load		BOOLEAN	RO	0x00 (0 <sub>dec</sub> )
6022:04	Short to 24V		BOOLEAN	RO	0x00 (0 <sub>dec</sub> )

**Index 6032 DO Diagnosis Ch.04**

Index (hex)	Name	Meaning	Data type	Flags	Default
6032:0	DO Diagnosis Ch.04	Diagnostic information	UINT8	RO	0x04 (4 <sub>dec</sub> )
6032:01	Overcurrent		BOOLEAN	RO	0x00 (0 <sub>dec</sub> )
6032:02	Overload		BOOLEAN	RO	0x00 (0 <sub>dec</sub> )
6032:03	Open load		BOOLEAN	RO	0x00 (0 <sub>dec</sub> )
6032:04	Short to 24V		BOOLEAN	RO	0x00 (0 <sub>dec</sub> )

**Index 6042 DO Diagnosis Ch.05**

Index (hex)	Name	Meaning	Data type	Flags	Default
6042:0	DO Diagnosis Ch.05	Diagnostic information	UINT8	RO	0x04 (4 <sub>dec</sub> )
6042:01	Overcurrent		BOOLEAN	RO	0x00 (0 <sub>dec</sub> )
6042:02	Overload		BOOLEAN	RO	0x00 (0 <sub>dec</sub> )
6042:03	Open load		BOOLEAN	RO	0x00 (0 <sub>dec</sub> )
6042:04	Short to 24V		BOOLEAN	RO	0x00 (0 <sub>dec</sub> )

**Index 6052 DO Diagnosis Ch.06**

Index (hex)	Name	Meaning	Data type	Flags	Default
6052:0	DO Diagnosis Ch.06	Diagnostic information	UINT8	RO	0x04 (4 <sub>dec</sub> )
6052:01	Overcurrent		BOOLEAN	RO	0x00 (0 <sub>dec</sub> )
6052:02	Overload		BOOLEAN	RO	0x00 (0 <sub>dec</sub> )
6052:03	Open load		BOOLEAN	RO	0x00 (0 <sub>dec</sub> )
6052:04	Short to 24V		BOOLEAN	RO	0x00 (0 <sub>dec</sub> )

**Index 6062 DO Diagnosis Ch.07**

Index (hex)	Name	Meaning	Data type	Flags	Default
6062:0	DO Diagnosis Ch.07	Diagnostic information	UINT8	RO	0x04 (4 <sub>dec</sub> )
6062:01	Overcurrent		BOOLEAN	RO	0x00 (0 <sub>dec</sub> )
6062:02	Overload		BOOLEAN	RO	0x00 (0 <sub>dec</sub> )
6062:03	Open load		BOOLEAN	RO	0x00 (0 <sub>dec</sub> )
6062:04	Short to 24V		BOOLEAN	RO	0x00 (0 <sub>dec</sub> )

**Index 6072 DO Diagnosis Ch.08**

Index (hex)	Name	Meaning	Data type	Flags	Default
6072:0	DO Diagnosis Ch.08	Diagnostic information	UINT8	RO	0x04 (4 <sub>dec</sub> )
6072:01	Overcurrent		BOOLEAN	RO	0x00 (0 <sub>dec</sub> )
6072:02	Overload		BOOLEAN	RO	0x00 (0 <sub>dec</sub> )
6072:03	Open load		BOOLEAN	RO	0x00 (0 <sub>dec</sub> )
6072:04	Short to 24V		BOOLEAN	RO	0x00 (0 <sub>dec</sub> )

**Index 6082 DO Diagnosis Ch.09**

Index (hex)	Name	Meaning	Data type	Flags	Default
6082:0	DO Diagnosis Ch.09	Diagnostic information	UINT8	RO	0x04 (4 <sub>dec</sub> )
6082:01	Overcurrent		BOOLEAN	RO	0x00 (0 <sub>dec</sub> )
6082:02	Overload		BOOLEAN	RO	0x00 (0 <sub>dec</sub> )
6082:03	Open load		BOOLEAN	RO	0x00 (0 <sub>dec</sub> )
6082:04	Short to 24V		BOOLEAN	RO	0x00 (0 <sub>dec</sub> )

**Index 6092 DO Diagnosis Ch.10**

Index (hex)	Name	Meaning	Data type	Flags	Default
6092:0	DO Diagnosis Ch.10	Diagnostic information	UINT8	RO	0x04 (4 <sub>dec</sub> )
6092:01	Overcurrent		BOOLEAN	RO	0x00 (0 <sub>dec</sub> )
6092:02	Overload		BOOLEAN	RO	0x00 (0 <sub>dec</sub> )
6092:03	Open load		BOOLEAN	RO	0x00 (0 <sub>dec</sub> )
6092:04	Short to 24V		BOOLEAN	RO	0x00 (0 <sub>dec</sub> )

**Index 60A2 DO Diagnosis Ch.11**

Index (hex)	Name	Meaning	Data type	Flags	Default
60A2:0	DO Diagnosis Ch.11	Diagnostic information	UINT8	RO	0x04 (4 <sub>dec</sub> )
60A2:01	Overcurrent		BOOLEAN	RO	0x00 (0 <sub>dec</sub> )
60A2:02	Overload		BOOLEAN	RO	0x00 (0 <sub>dec</sub> )
60A2:03	Open load		BOOLEAN	RO	0x00 (0 <sub>dec</sub> )
60A2:04	Short to 24V		BOOLEAN	RO	0x00 (0 <sub>dec</sub> )

**Index 60B2 DO Diagnosis Ch.12**

Index (hex)	Name	Meaning	Data type	Flags	Default
60B2:0	DO Diagnosis Ch.12	Diagnostic information	UINT8	RO	0x04 (4 <sub>dec</sub> )
60B2:01	Overcurrent		BOOLEAN	RO	0x00 (0 <sub>dec</sub> )
60B2:02	Overload		BOOLEAN	RO	0x00 (0 <sub>dec</sub> )
60B2:03	Open load		BOOLEAN	RO	0x00 (0 <sub>dec</sub> )
60B2:04	Short to 24V		BOOLEAN	RO	0x00 (0 <sub>dec</sub> )

**Index 60C2 DO Diagnosis Ch.13**

Index (hex)	Name	Meaning	Data type	Flags	Default
60C2:0	DO Diagnosis Ch.13	Diagnostic information	UINT8	RO	0x04 (4 <sub>dec</sub> )
60C2:01	Overcurrent		BOOLEAN	RO	0x00 (0 <sub>dec</sub> )
60C2:02	Overload		BOOLEAN	RO	0x00 (0 <sub>dec</sub> )
60C2:03	Open load		BOOLEAN	RO	0x00 (0 <sub>dec</sub> )
60C2:04	Short to 24V		BOOLEAN	RO	0x00 (0 <sub>dec</sub> )

**Index 60D2 DO Diagnosis Ch.14**

Index (hex)	Name	Meaning	Data type	Flags	Default
60D2:0	DO Diagnosis Ch.14	Diagnostic information	UINT8	RO	0x04 (4 <sub>dec</sub> )
60D2:01	Overcurrent		BOOLEAN	RO	0x00 (0 <sub>dec</sub> )
60D2:02	Overload		BOOLEAN	RO	0x00 (0 <sub>dec</sub> )
60D2:03	Open load		BOOLEAN	RO	0x00 (0 <sub>dec</sub> )
60D2:04	Short to 24V		BOOLEAN	RO	0x00 (0 <sub>dec</sub> )

**Index 60E2 DO Diagnosis Ch.15**

Index (hex)	Name	Meaning	Data type	Flags	Default
60E2:0	DO Diagnosis Ch.15	Diagnostic information	UINT8	RO	0x04 (4 <sub>dec</sub> )
60E2:01	Overcurrent		BOOLEAN	RO	0x00 (0 <sub>dec</sub> )
60E2:02	Overload		BOOLEAN	RO	0x00 (0 <sub>dec</sub> )
60E2:03	Open load		BOOLEAN	RO	0x00 (0 <sub>dec</sub> )
60E2:04	Short to 24V		BOOLEAN	RO	0x00 (0 <sub>dec</sub> )

**Index 60F2 DO Diagnosis Ch.16**

Index (hex)	Name	Meaning	Data type	Flags	Default
60F2:0	DO Diagnosis Ch.16	Diagnostic information	UINT8	RO	0x04 (4 <sub>dec</sub> )
60F2:01	Overcurrent		BOOLEAN	RO	0x00 (0 <sub>dec</sub> )
60F2:02	Overload		BOOLEAN	RO	0x00 (0 <sub>dec</sub> )
60F2:03	Open load		BOOLEAN	RO	0x00 (0 <sub>dec</sub> )
60F2:04	Short to 24V		BOOLEAN	RO	0x00 (0 <sub>dec</sub> )

**Index 7000 DO Output Ch.01**

Index (hex)	Name	Meaning	Data type	Flags	Default
7000:0	DO Output Ch.01	Process data	UINT8	RO	0x01 (1 <sub>dec</sub> )
7000:01	Output		BOOLEAN	RO	0x00 (0 <sub>dec</sub> )

**Index 7010 DO Output Ch.02**

Index (hex)	Name	Meaning	Data type	Flags	Default
7010:0	DO Output Ch.02	Process data	UINT8	RO	0x01 (1 <sub>dec</sub> )
7010:01	Output		BOOLEAN	RO	0x00 (0 <sub>dec</sub> )

**Index 7020 DO Output Ch.03**

Index (hex)	Name	Meaning	Data type	Flags	Default
7020:0	DO Output Ch.03	Process data	UINT8	RO	0x01 (1 <sub>dec</sub> )
7020:01	Output		BOOLEAN	RO	0x00 (0 <sub>dec</sub> )

**Index 7030 DO Output Ch.04**

Index (hex)	Name	Meaning	Data type	Flags	Default
7030:0	DO Output Ch.04	Process data	UINT8	RO	0x01 (1 <sub>dec</sub> )
7030:01	Output		BOOLEAN	RO	0x00 (0 <sub>dec</sub> )

**Index 7040 DO Output Ch.05**

Index (hex)	Name	Meaning	Data type	Flags	Default
7040:0	DO Output Ch.05	Process data	UINT8	RO	0x01 (1 <sub>dec</sub> )
7040:01	Output		BOOLEAN	RO	0x00 (0 <sub>dec</sub> )

**Index 7050 DO Output Ch.06**

Index (hex)	Name	Meaning	Data type	Flags	Default
7050:0	DO Output Ch.06	Process data	UINT8	RO	0x01 (1 <sub>dec</sub> )
7050:01	Output		BOOLEAN	RO	0x00 (0 <sub>dec</sub> )

**Index 7060 DO Output Ch.07**

Index (hex)	Name	Meaning	Data type	Flags	Default
7060:0	DO Output Ch.07	Process data	UINT8	RO	0x01 (1 <sub>dec</sub> )
7060:01	Output		BOOLEAN	RO	0x00 (0 <sub>dec</sub> )

**Index 7070 DO Output Ch.08**

Index (hex)	Name	Meaning	Data type	Flags	Default
7070:0	DO Output Ch.08	Process data	UINT8	RO	0x01 (1 <sub>dec</sub> )
7070:01	Output		BOOLEAN	RO	0x00 (0 <sub>dec</sub> )

**Index 7080 DO Output Ch.09**

Index (hex)	Name	Meaning	Data type	Flags	Default
7080:0	DO Output Ch.09	Process data	UINT8	RO	0x01 (1 <sub>dec</sub> )
7080:01	Output		BOOLEAN	RO	0x00 (0 <sub>dec</sub> )

**Index 7090 DO Output Ch.10**

Index (hex)	Name	Meaning	Data type	Flags	Default
7090:0	DO Output Ch.10	Process data	UINT8	RO	0x01 (1 <sub>dec</sub> )
7090:01	Output		BOOLEAN	RO	0x00 (0 <sub>dec</sub> )

**Index 70A0 DO Output Ch.11**

Index (hex)	Name	Meaning	Data type	Flags	Default
70A0:0	DO Output Ch.11	Process data	UINT8	RO	0x01 (1 <sub>dec</sub> )
70A00:01	Output		BOOLEAN	RO	0x00 (0 <sub>dec</sub> )

**Index 70B0 DO Output Ch.12**

Index (hex)	Name	Meaning	Data type	Flags	Default
70B0:0	DO Output Ch.12	Process data	UINT8	RO	0x01 (1 <sub>dec</sub> )
70B00:01	Output		BOOLEAN	RO	0x00 (0 <sub>dec</sub> )



**Index 70C0 DO Output Ch.13**

Index (hex)	Name	Meaning	Data type	Flags	Default
70C0:0	DO Output Ch.13	Process data	UINT8	RO	0x01 (1 <sub>dec</sub> )
70C00:01	Output		BOOLEAN	RO	0x00 (0 <sub>dec</sub> )

**Index 70D0 DO Output Ch.14**

Index (hex)	Name	Meaning	Data type	Flags	Default
70D0:0	DO Output Ch.14	Process data	UINT8	RO	0x01 (1 <sub>dec</sub> )
70D00:01	Output		BOOLEAN	RO	0x00 (0 <sub>dec</sub> )

**Index 70E0 DO Output Ch.15**

Index (hex)	Name	Meaning	Data type	Flags	Default
70E0:0	DO Output Ch.15	Process data	UINT8	RO	0x01 (1 <sub>dec</sub> )
70E00:01	Output		BOOLEAN	RO	0x00 (0 <sub>dec</sub> )

**Index 70F0 DO Output Ch.16**

Index (hex)	Name	Meaning	Data type	Flags	Default
70F0:0	DO Output Ch.16	Process data	UINT8	RO	0x01 (1 <sub>dec</sub> )
70F00:01	Output		BOOLEAN	RO	0x00 (0 <sub>dec</sub> )

**Index 8000 DO Settings Ch.01**

Index (hex)	Name	Meaning	Data type	Flags	Default
8000:0	DO Settings Ch.01	Parameters for the digital output channel 1 / connection X01.	UINT8	RO	0x05 (5 <sub>dec</sub> )
8000:01	Detect open wire in off state	Enable wire break detection when the output is switched off. See chapter <a href="#">Enable additional diagnostic functions</a> <a href="#">▶ 126</a> .	BOOLEAN	RW	0x00 (0 <sub>dec</sub> )
8000:02	Detect open wire in on state	Enable wire break detection when the output is switched on. See chapter <a href="#">Enable additional diagnostic functions</a> <a href="#">▶ 126</a> .	BOOLEAN	RW	0x00 (0 <sub>dec</sub> )
8000:03	Detect short to 24V	Enable detection of short circuits after 24 V. See chapter <a href="#">Enable additional diagnostic functions</a> <a href="#">▶ 126</a> .	BOOLEAN	RW	0x00 (0 <sub>dec</sub> )
8000:04	Safe state active	Configuration of the behavior in case of EtherCAT failure. See chapter <a href="#">Behavior on EtherCAT failure</a> <a href="#">▶ 121</a> .	BOOLEAN	RW	0x01 (1 <sub>dec</sub> )
8000:05	Safe state value		BOOLEAN	RW	0x00 (0 <sub>dec</sub> )

## Index 8010 DO Settings Ch.02

Index (hex)	Name	Meaning	Data type	Flags	Default
8010:0	DO Settings Ch.02	Parameters for the digital output channel 2 / connection X02.	UINT8	RO	0x05 (5 <sub>dec</sub> )
8010:01	Detect open wire in off state	Enable wire break detection when the output is switched off. See chapter <a href="#">Enable additional diagnostic functions</a> <a href="#">▶ 126</a> .	BOOLEAN	RW	0x00 (0 <sub>dec</sub> )
8010:02	Detect open wire in on state	Enable wire break detection when the output is switched on. See chapter <a href="#">Enable additional diagnostic functions</a> <a href="#">▶ 126</a> .	BOOLEAN	RW	0x00 (0 <sub>dec</sub> )
8010:03	Detect short to 24V	Enable detection of short circuits after 24 V. See chapter <a href="#">Enable additional diagnostic functions</a> <a href="#">▶ 126</a> .	BOOLEAN	RW	0x00 (0 <sub>dec</sub> )
8010:04	Safe state active	Configuration of the behavior in case of EtherCAT failure. See chapter <a href="#">Behavior on EtherCAT failure</a> <a href="#">▶ 121</a> .	BOOLEAN	RW	0x01 (1 <sub>dec</sub> )
8010:05	Safe state value		BOOLEAN	RW	0x00 (0 <sub>dec</sub> )

## Index 8020 DO Settings Ch.03

Index (hex)	Name	Meaning	Data type	Flags	Default
8020:0	DO Settings Ch.03	Parameters for the digital output channel 3 / connection X03.	UINT8	RO	0x05 (5 <sub>dec</sub> )
8020:01	Detect open wire in off state	Enable wire break detection when the output is switched off. See chapter <a href="#">Enable additional diagnostic functions</a> <a href="#">▶ 126</a> .	BOOLEAN	RW	0x00 (0 <sub>dec</sub> )
8020:02	Detect open wire in on state	Enable wire break detection when the output is switched on. See chapter <a href="#">Enable additional diagnostic functions</a> <a href="#">▶ 126</a> .	BOOLEAN	RW	0x00 (0 <sub>dec</sub> )
8020:03	Detect short to 24V	Enable detection of short circuits after 24 V. See chapter <a href="#">Enable additional diagnostic functions</a> <a href="#">▶ 126</a> .	BOOLEAN	RW	0x00 (0 <sub>dec</sub> )
8020:04	Safe state active	Configuration of the behavior in case of EtherCAT failure. See chapter <a href="#">Behavior on EtherCAT failure</a> <a href="#">▶ 121</a> .	BOOLEAN	RW	0x01 (1 <sub>dec</sub> )
8020:05	Safe state value		BOOLEAN	RW	0x00 (0 <sub>dec</sub> )

## Index 8030 DO Settings Ch.04

Index (hex)	Name	Meaning	Data type	Flags	Default
8030:0	DO Settings Ch.04	Parameters for the digital output channel 4 / connection X04.	UINT8	RO	0x05 (5 <sub>dec</sub> )
8030:01	Detect open wire in off state	Enable wire break detection when the output is switched off. See chapter <a href="#">Enable additional diagnostic functions</a> <a href="#">▶ 126</a> .	BOOLEAN	RW	0x00 (0 <sub>dec</sub> )
8030:02	Detect open wire in on state	Enable wire break detection when the output is switched on. See chapter <a href="#">Enable additional diagnostic functions</a> <a href="#">▶ 126</a> .	BOOLEAN	RW	0x00 (0 <sub>dec</sub> )
8030:03	Detect short to 24V	Enable detection of short circuits after 24 V. See chapter <a href="#">Enable additional diagnostic functions</a> <a href="#">▶ 126</a> .	BOOLEAN	RW	0x00 (0 <sub>dec</sub> )
8030:04	Safe state active	Configuration of the behavior in case of EtherCAT failure. See chapter <a href="#">Behavior on EtherCAT failure</a> <a href="#">▶ 121</a> .	BOOLEAN	RW	0x01 (1 <sub>dec</sub> )
8030:05	Safe state value		BOOLEAN	RW	0x00 (0 <sub>dec</sub> )

**Index 8040 DO Settings Ch.05**

Index (hex)	Name	Meaning	Data type	Flags	Default
8040:0	DO Settings Ch.05	Parameters for the digital output channel 5 / connection X05.	UINT8	RO	0x05 (5 <sub>dec</sub> )
8040:01	Detect open wire in off state	Enable wire break detection when the output is switched off. See chapter <a href="#">Enable additional diagnostic functions</a> <a href="#">▶ 126</a> .	BOOLEAN	RW	0x00 (0 <sub>dec</sub> )
8040:02	Detect open wire in on state	Enable wire break detection when the output is switched on. See chapter <a href="#">Enable additional diagnostic functions</a> <a href="#">▶ 126</a> .	BOOLEAN	RW	0x00 (0 <sub>dec</sub> )
8040:03	Detect short to 24V	Enable detection of short circuits after 24 V. See chapter <a href="#">Enable additional diagnostic functions</a> <a href="#">▶ 126</a> .	BOOLEAN	RW	0x00 (0 <sub>dec</sub> )
8040:04	Safe state active	Configuration of the behavior in case of EtherCAT failure. See chapter <a href="#">Behavior on EtherCAT failure</a> <a href="#">▶ 121</a> .	BOOLEAN	RW	0x01 (1 <sub>dec</sub> )
8040:05	Safe state value		BOOLEAN	RW	0x00 (0 <sub>dec</sub> )

**Index 8050 DO Settings Ch.06**

Index (hex)	Name	Meaning	Data type	Flags	Default
8050:0	DO Settings Ch.06	Parameters for the digital output channel 6 / connection X06.	UINT8	RO	0x05 (5 <sub>dec</sub> )
8050:01	Detect open wire in off state	Enable wire break detection when the output is switched off. See chapter <a href="#">Enable additional diagnostic functions</a> <a href="#">▶ 126</a> .	BOOLEAN	RW	0x00 (0 <sub>dec</sub> )
8050:02	Detect open wire in on state	Enable wire break detection when the output is switched on. See chapter <a href="#">Enable additional diagnostic functions</a> <a href="#">▶ 126</a> .	BOOLEAN	RW	0x00 (0 <sub>dec</sub> )
8050:03	Detect short to 24V	Enable detection of short circuits after 24 V. See chapter <a href="#">Enable additional diagnostic functions</a> <a href="#">▶ 126</a> .	BOOLEAN	RW	0x00 (0 <sub>dec</sub> )
8050:04	Safe state active	Configuration of the behavior in case of EtherCAT failure. See chapter <a href="#">Behavior on EtherCAT failure</a> <a href="#">▶ 121</a> .	BOOLEAN	RW	0x01 (1 <sub>dec</sub> )
8050:05	Safe state value		BOOLEAN	RW	0x00 (0 <sub>dec</sub> )

**Index 8060 DO Settings Ch.07**

Index (hex)	Name	Meaning	Data type	Flags	Default
8060:0	DO Settings Ch.07	Parameters for the digital output channel 7 / connection X07.	UINT8	RO	0x05 (5 <sub>dec</sub> )
8060:01	Detect open wire in off state	Enable wire break detection when the output is switched off. See chapter <a href="#">Enable additional diagnostic functions</a> <a href="#">▶ 126</a> .	BOOLEAN	RW	0x00 (0 <sub>dec</sub> )
8060:02	Detect open wire in on state	Enable wire break detection when the output is switched on. See chapter <a href="#">Enable additional diagnostic functions</a> <a href="#">▶ 126</a> .	BOOLEAN	RW	0x00 (0 <sub>dec</sub> )
8060:03	Detect short to 24V	Enable detection of short circuits after 24 V. See chapter <a href="#">Enable additional diagnostic functions</a> <a href="#">▶ 126</a> .	BOOLEAN	RW	0x00 (0 <sub>dec</sub> )
8060:04	Safe state active	Configuration of the behavior in case of EtherCAT failure. See chapter <a href="#">Behavior on EtherCAT failure</a> <a href="#">▶ 121</a> .	BOOLEAN	RW	0x01 (1 <sub>dec</sub> )
8060:05	Safe state value		BOOLEAN	RW	0x00 (0 <sub>dec</sub> )

## Index 8070 DO Settings Ch.08

Index (hex)	Name	Meaning	Data type	Flags	Default
8070:0	DO Settings Ch.08	Parameters for the digital output channel 8 / connection X08.	UINT8	RO	0x05 (5 <sub>dec</sub> )
8070:01	Detect open wire in off state	Enable wire break detection when the output is switched off. See chapter <a href="#">Enable additional diagnostic functions</a> <a href="#">▶ 126</a> .	BOOLEAN	RW	0x00 (0 <sub>dec</sub> )
8070:02	Detect open wire in on state	Enable wire break detection when the output is switched on. See chapter <a href="#">Enable additional diagnostic functions</a> <a href="#">▶ 126</a> .	BOOLEAN	RW	0x00 (0 <sub>dec</sub> )
8070:03	Detect short to 24V	Enable detection of short circuits after 24 V. See chapter <a href="#">Enable additional diagnostic functions</a> <a href="#">▶ 126</a> .	BOOLEAN	RW	0x00 (0 <sub>dec</sub> )
8070:04	Safe state active	Configuration of the behavior in case of EtherCAT failure. See chapter <a href="#">Behavior on EtherCAT failure</a> <a href="#">▶ 121</a> .	BOOLEAN	RW	0x01 (1 <sub>dec</sub> )
8070:05	Safe state value		BOOLEAN	RW	0x00 (0 <sub>dec</sub> )

## Index 8080 DO Settings Ch.09

Index (hex)	Name	Meaning	Data type	Flags	Default
8080:0	DO Settings Ch.09	Parameters for the digital output channel 9 / connection X09.	UINT8	RO	0x05 (5 <sub>dec</sub> )
8080:01	Detect open wire in off state	Enable wire break detection when the output is switched off. See chapter <a href="#">Enable additional diagnostic functions</a> <a href="#">▶ 126</a> .	BOOLEAN	RW	0x00 (0 <sub>dec</sub> )
8080:02	Detect open wire in on state	Enable wire break detection when the output is switched on. See chapter <a href="#">Enable additional diagnostic functions</a> <a href="#">▶ 126</a> .	BOOLEAN	RW	0x00 (0 <sub>dec</sub> )
8080:03	Detect short to 24V	Enable detection of short circuits after 24 V. See chapter <a href="#">Enable additional diagnostic functions</a> <a href="#">▶ 126</a> .	BOOLEAN	RW	0x00 (0 <sub>dec</sub> )
8080:04	Safe state active	Configuration of the behavior in case of EtherCAT failure. See chapter <a href="#">Behavior on EtherCAT failure</a> <a href="#">▶ 121</a> .	BOOLEAN	RW	0x01 (1 <sub>dec</sub> )
8080:05	Safe state value		BOOLEAN	RW	0x00 (0 <sub>dec</sub> )

## Index 8090 DO Settings Ch.10

Index (hex)	Name	Meaning	Data type	Flags	Default
8090:0	DO Settings Ch.10	Parameters for the digital output channel 10 / connection X10.	UINT8	RO	0x05 (5 <sub>dec</sub> )
8090:01	Detect open wire in off state	Enable wire break detection when the output is switched off. See chapter <a href="#">Enable additional diagnostic functions</a> <a href="#">▶ 126</a> .	BOOLEAN	RW	0x00 (0 <sub>dec</sub> )
8090:02	Detect open wire in on state	Enable wire break detection when the output is switched on. See chapter <a href="#">Enable additional diagnostic functions</a> <a href="#">▶ 126</a> .	BOOLEAN	RW	0x00 (0 <sub>dec</sub> )
8090:03	Detect short to 24V	Enable detection of short circuits after 24 V. See chapter <a href="#">Enable additional diagnostic functions</a> <a href="#">▶ 126</a> .	BOOLEAN	RW	0x00 (0 <sub>dec</sub> )
8090:04	Safe state active	Configuration of the behavior in case of EtherCAT failure. See chapter <a href="#">Behavior on EtherCAT failure</a> <a href="#">▶ 121</a> .	BOOLEAN	RW	0x01 (1 <sub>dec</sub> )
8090:05	Safe state value		BOOLEAN	RW	0x00 (0 <sub>dec</sub> )

**Index 80A0 DO Settings Ch.11**

Index (hex)	Name	Meaning	Data type	Flags	Default
80A0:0	DO Settings Ch.11	Parameters for the digital output channel 11 / connection X11.	UINT8	RO	0x05 (5 <sub>dec</sub> )
80A00:01	Detect open wire in off state	Enable wire break detection when the output is switched off. See chapter <a href="#">Enable additional diagnostic functions</a> <a href="#">▶ 126</a> .	BOOLEAN	RW	0x00 (0 <sub>dec</sub> )
80A00:02	Detect open wire in on state	Enable wire break detection when the output is switched on. See chapter <a href="#">Enable additional diagnostic functions</a> <a href="#">▶ 126</a> .	BOOLEAN	RW	0x00 (0 <sub>dec</sub> )
80A00:03	Detect short to 24V	Enable detection of short circuits after 24 V. See chapter <a href="#">Enable additional diagnostic functions</a> <a href="#">▶ 126</a> .	BOOLEAN	RW	0x00 (0 <sub>dec</sub> )
80A00:04	Safe state active	Configuration of the behavior in case of EtherCAT failure. See chapter <a href="#">Behavior on EtherCAT failure</a> <a href="#">▶ 121</a> .	BOOLEAN	RW	0x01 (1 <sub>dec</sub> )
80A00:05	Safe state value		BOOLEAN	RW	0x00 (0 <sub>dec</sub> )

**Index 80B0 DO Settings Ch.12**

Index (hex)	Name	Meaning	Data type	Flags	Default
80B0:0	DO Settings Ch.12	Parameters for the digital output channel 12 / connection X12.	UINT8	RO	0x05 (5 <sub>dec</sub> )
80B00:01	Detect open wire in off state	Enable wire break detection when the output is switched off. See chapter <a href="#">Enable additional diagnostic functions</a> <a href="#">▶ 126</a> .	BOOLEAN	RW	0x00 (0 <sub>dec</sub> )
80B00:02	Detect open wire in on state	Enable wire break detection when the output is switched on. See chapter <a href="#">Enable additional diagnostic functions</a> <a href="#">▶ 126</a> .	BOOLEAN	RW	0x00 (0 <sub>dec</sub> )
80B00:03	Detect short to 24V	Enable detection of short circuits after 24 V. See chapter <a href="#">Enable additional diagnostic functions</a> <a href="#">▶ 126</a> .	BOOLEAN	RW	0x00 (0 <sub>dec</sub> )
80B00:04	Safe state active	Configuration of the behavior in case of EtherCAT failure. See chapter <a href="#">Behavior on EtherCAT failure</a> <a href="#">▶ 121</a> .	BOOLEAN	RW	0x01 (1 <sub>dec</sub> )
80B00:05	Safe state value		BOOLEAN	RW	0x00 (0 <sub>dec</sub> )

**Index 80C0 DO Settings Ch.13**

Index (hex)	Name	Meaning	Data type	Flags	Default
80C0:0	DO Settings Ch.13	Parameters for the digital output channel 13 / connection X13.	UINT8	RO	0x05 (5 <sub>dec</sub> )
80C00:01	Detect open wire in off state	Enable wire break detection when the output is switched off. See chapter <a href="#">Enable additional diagnostic functions</a> <a href="#">▶ 126</a> .	BOOLEAN	RW	0x00 (0 <sub>dec</sub> )
80C00:02	Detect open wire in on state	Enable wire break detection when the output is switched on. See chapter <a href="#">Enable additional diagnostic functions</a> <a href="#">▶ 126</a> .	BOOLEAN	RW	0x00 (0 <sub>dec</sub> )
80C00:03	Detect short to 24V	Enable detection of short circuits after 24 V. See chapter <a href="#">Enable additional diagnostic functions</a> <a href="#">▶ 126</a> .	BOOLEAN	RW	0x00 (0 <sub>dec</sub> )
80C00:04	Safe state active	Configuration of the behavior in case of EtherCAT failure. See chapter <a href="#">Behavior on EtherCAT failure</a> <a href="#">▶ 121</a> .	BOOLEAN	RW	0x01 (1 <sub>dec</sub> )
80C00:05	Safe state value		BOOLEAN	RW	0x00 (0 <sub>dec</sub> )

## Index 80D0 DO Settings Ch.14

Index (hex)	Name	Meaning	Data type	Flags	Default
80D0:0	DO Settings Ch.14	Parameters for the digital output channel 14 / connection X14.	UINT8	RO	0x05 (5 <sub>dec</sub> )
80D00:01	Detect open wire in off state	Enable wire break detection when the output is switched off. See chapter <a href="#">Enable additional diagnostic functions</a> <a href="#">▶ 126</a> .	BOOLEAN	RW	0x00 (0 <sub>dec</sub> )
80D00:02	Detect open wire in on state	Enable wire break detection when the output is switched on. See chapter <a href="#">Enable additional diagnostic functions</a> <a href="#">▶ 126</a> .	BOOLEAN	RW	0x00 (0 <sub>dec</sub> )
80D00:03	Detect short to 24V	Enable detection of short circuits after 24 V. See chapter <a href="#">Enable additional diagnostic functions</a> <a href="#">▶ 126</a> .	BOOLEAN	RW	0x00 (0 <sub>dec</sub> )
80D00:04	Safe state active	Configuration of the behavior in case of EtherCAT failure. See chapter <a href="#">Behavior on EtherCAT failure</a> <a href="#">▶ 121</a> .	BOOLEAN	RW	0x01 (1 <sub>dec</sub> )
80D00:05	Safe state value		BOOLEAN	RW	0x00 (0 <sub>dec</sub> )

## Index 80E0 DO Settings Ch.15

Index (hex)	Name	Meaning	Data type	Flags	Default
80E0:0	DO Settings Ch.15	Parameters for the digital output channel 15 / connection X15.	UINT8	RO	0x05 (5 <sub>dec</sub> )
80E00:01	Detect open wire in off state	Enable wire break detection when the output is switched off. See chapter <a href="#">Enable additional diagnostic functions</a> <a href="#">▶ 126</a> .	BOOLEAN	RW	0x00 (0 <sub>dec</sub> )
80E00:02	Detect open wire in on state	Enable wire break detection when the output is switched on. See chapter <a href="#">Enable additional diagnostic functions</a> <a href="#">▶ 126</a> .	BOOLEAN	RW	0x00 (0 <sub>dec</sub> )
80E00:03	Detect short to 24V	Enable detection of short circuits after 24 V. See chapter <a href="#">Enable additional diagnostic functions</a> <a href="#">▶ 126</a> .	BOOLEAN	RW	0x00 (0 <sub>dec</sub> )
80E00:04	Safe state active	Configuration of the behavior in case of EtherCAT failure. See chapter <a href="#">Behavior on EtherCAT failure</a> <a href="#">▶ 121</a> .	BOOLEAN	RW	0x01 (1 <sub>dec</sub> )
80E00:05	Safe state value		BOOLEAN	RW	0x00 (0 <sub>dec</sub> )

## Index 80F0 DO Settings Ch.16

Index (hex)	Name	Meaning	Data type	Flags	Default
80F0:0	DO Settings Ch.16	Parameters for the digital output channel 16 / connection X16.	UINT8	RO	0x05 (5 <sub>dec</sub> )
80F00:01	Detect open wire in off state	Enable wire break detection when the output is switched off. See chapter <a href="#">Enable additional diagnostic functions</a> <a href="#">▶ 126</a> .	BOOLEAN	RW	0x00 (0 <sub>dec</sub> )
80F00:02	Detect open wire in on state	Enable wire break detection when the output is switched on. See chapter <a href="#">Enable additional diagnostic functions</a> <a href="#">▶ 126</a> .	BOOLEAN	RW	0x00 (0 <sub>dec</sub> )
80F00:03	Detect short to 24V	Enable detection of short circuits after 24 V. See chapter <a href="#">Enable additional diagnostic functions</a> <a href="#">▶ 126</a> .	BOOLEAN	RW	0x00 (0 <sub>dec</sub> )
80F00:04	Safe state active	Configuration of the behavior in case of EtherCAT failure. See chapter <a href="#">Behavior on EtherCAT failure</a> <a href="#">▶ 121</a> .	BOOLEAN	RW	0x01 (1 <sub>dec</sub> )
80F00:05	Safe state value		BOOLEAN	RW	0x00 (0 <sub>dec</sub> )

**Index F000 Modular Device Profile**

Index (hex)	Name	Meaning	Data type	Flags	Default
000:0F	Modular Device Profile	General information for the modular device profile	UINT8	RO	0x02 (2 <sub>dec</sub> )
F000:01	Index distance	Index distance of the objects of the individual channels	UINT16	RO	0x0010 (16 <sub>dec</sub> )
000F:02	Maximum number of modules	Number of channels	UINT16	RO	0x0010 (16 <sub>dec</sub> )

**Index F008 Code word**

Index (hex)	Name	Meaning	Data type	Flags	Default
F008:0	Code word		UINT32	RW	0x00000000 (0 <sub>dec</sub> )

**Index F600 DEV Inputs**

Index (hex)	Name	Meaning	Data type	Flags	Default
F600:0	DEV Inputs		UINT8	RO	0x17 (23 <sub>dec</sub> )
600:01F	Undervoltage Us		BOOLEAN	RO	0x00 (0 <sub>dec</sub> )
F600:02	Undervoltage Up		BOOLEAN	RO	0x00 (0 <sub>dec</sub> )
F600:03	Overtemperature		BOOLEAN	RO	0x00 (0 <sub>dec</sub> )
F600:0D	Diag		BOOLEAN	RO	0x00 (0 <sub>dec</sub> )
F600:0E	TxPDO State		BOOLEAN	RO	0x00 (0 <sub>dec</sub> )
F600:0F	Input cycle counter		BIT2	RO	0x00 (0 <sub>dec</sub> )
F600:16	Voltage Us		UINT32	RO	0x00000000 (0 <sub>dec</sub> )
F600:17	Voltage Up		UINT32	RO	0x00000000 (0 <sub>dec</sub> )

**Index F800 DEV Settings**

Index (hex)	Name	Meaning	Data type	Flags	Default
F800:0	DEV Settings		UINT8	RO	0x12 (18 <sub>dec</sub> )
F800:10	Us undervoltage detection threshold		UINT16	RW	0x47E0 (18400 <sub>dec</sub> )
800:12F	Up undervoltage detection threshold		UINT16	RW	0x47E0 (18400 <sub>dec</sub> )

**Index F80F DEV Vendor data**

Index (hex)	Name	Meaning	Data type	Flags	Default
F80F:0	DEV Vendor data		UINT8	RO	0x04 (4 <sub>dec</sub> )
F80F:01	Offset Us		REAL32	RW	0x00000000 (0 <sub>dec</sub> )
F80F:02	Gain Us		REAL32	RW	0x3F800000 (1065353216 <sub>dec</sub> )
F80F:03	Offset Up		REAL32	RW	0x00000000 (0 <sub>dec</sub> )
F80F:04	Gain Up		REAL32	RW	0x3F800000 (1065353216 <sub>dec</sub> )

**Index F900 DEV Info data**

Index (hex)	Name	Meaning	Data type	Flags	Default
F900:0	DEV Info data		UINT8	RO	0x05 (5 <sub>dec</sub> )
F900:02	Internal Temperature		INT8	RO	0x00 (0 <sub>dec</sub> )
F900:04	Voltage Us		UINT16	RO	0x0000 (0 <sub>dec</sub> )
F900:05	Voltage Up		UINT16	RO	0x0000 (0 <sub>dec</sub> )

**Index FB00 DEV Command**

Index (hex)	Name	Meaning	Data type	Flags	Default
FB00:0	DEV Command		UINT8	RO	0x03 (3 <sub>dec</sub> )
FB00:01	Request		OCTET-STRING[2]	RW	{0}
FB00:02	Status		UINT8	RO	0x00 (0 <sub>dec</sub> )
FB00:03	Response		OCTET-STRING[8]	RO	{0}



## 8 Appendix

### 8.1 General operating conditions

#### Protection rating according to IP code

The degrees of protection are defined and divided into different classes in the IEC 60529 standard (EN 60529). Degrees of protection are designated by the letters "IP" and two numerals: **IPxy**

- Numeral x: Dust protection and contact protection
- Numeral y: Protection against water

x	Meaning
0	Not protected
1	Protected against access to dangerous parts with the back of the hand. Protected against solid foreign objects of 50 mm Ø
2	Protected against access to dangerous parts with a finger. Protected against solid foreign objects of 12.5 mm Ø
3	Protected against access to dangerous parts with a tool. Protected against solid foreign objects of 2.5 mm Ø
4	Protected against access to dangerous parts with a wire. Protected against solid foreign objects of 1 mm Ø
5	Protection against access to dangerous parts with a wire. Dust-protected. Ingress of dust is not prevented completely, although the quantity of dust able to penetrate is limited to such an extent that the proper function of the device and safety are not impaired
6	Protection against access to dangerous parts with a wire. Dust-tight. No ingress of dust

y	Meaning
0	Not protected
1	Protection against vertically falling water drops
2	Protection against vertically falling water drops when enclosure tilted up to 15°
3	Protection against spraying water. Water sprayed at an angle of up to 60° on either side of the vertical shall have no harmful effects
4	Protection against splashing water. Water splashed against the enclosure from any direction shall have no harmful effects
5	Protection against water jets.
6	Protection against powerful water jets.
7	Protected against the effects of temporary immersion in water. Ingress of water in quantities causing harmful effects shall not be possible when the enclosure is immersed in water at a depth of 1 m for 30 minutes

#### Chemical resistance

The resistance refers to the housing of the IP67 modules and the metal parts used. In the table below you will find some typical resistances.

Type	Resistance
Water vapor	unstable at temperatures > 100 °C
Sodium hydroxide solution (ph value > 12)	stable at room temperature unstable > 40 °C
Acetic acid	unstable
Argon (technically pure)	stable

#### Key

- resistant: Lifetime several months
- non inherently resistant: Lifetime several weeks
- not resistant: Lifetime several hours resp. early decomposition

## 8.2 Accessories

### Mounting

Ordering information	Description	Link
ZS5300-0011	Mounting rail	<a href="#">Website</a>

### Cables

A complete overview of pre-assembled cables for fieldbus components can be found [here](#).

Ordering information	Description	Link
ZK1090-3xxx-xxxx	EtherCAT cable M8, green	<a href="#">Website</a>
ZK1093-3xxx-xxxx	EtherCAT cable M8, yellow	<a href="#">Website</a>
ZK1090-6xxx-xxxx	EtherCAT cable M12, green	<a href="#">Website</a>
ZK2000-2xxx-xxxx	Sensor cable M8, 3-pin	<a href="#">Website</a>
ZK2000-6xxx-xxxx	Sensor cable M12, 4-pin	<a href="#">Website</a>
ZK2000-7xxx-0xxx	Sensor cable M12, 4-pin + shield	<a href="#">Website</a>
ZK2020-3xxx-xxxx	Power cable M8, 4-pin	<a href="#">Website</a>
ZK203x-xxxx-xxxx	Power cable 7/8", 5-pin	<a href="#">Website</a>

### Connector

Ordering information	Description	Link
ZS2001-000x	Female header with spring connection, IP20	<a href="#">Website</a>
ZS2002-0111	D-sub connector, 25-pin	<a href="#">Website</a>

### Labeling material, protective caps

Ordering information	Description
ZS5000-0010	Protective cap for M8 sockets, IP67 (50 pieces)
ZS5000-0020	Protective cap for M12 sockets, IP67 (50 pcs.)
ZS5100-0000	Inscription labels, unprinted, 4 strips of 10
ZS5000-xxxx	Printed inscription labels on enquiry

### Tools

Ordering information	Description
ZB8801-0000	Torque wrench for plugs, 0.4...1.0 Nm
ZB8801-0001	Torque cable key for M8 / wrench size 9 for ZB8801-0000
ZB8801-0002	Torque cable key for M12 / wrench size 13 for ZB8801-0000
ZB8801-0003	Torque cable key for M12 field assembly / wrench size 18 for ZB8801-0000



#### Further accessories

Further accessories can be found in the price list for fieldbus components from Beckhoff and online at <https://www.beckhoff.com>.

## 8.3 Version identification of EtherCAT devices

### 8.3.1 General notes on marking

#### Designation

A Beckhoff EtherCAT device has a 14-digit designation, made up of

- family key
- type
- version
- revision

Example	Family	Type	Version	Revision
EL3314-0000-0016	EL terminal 12 mm, non-pluggable connection level	3314 4-channel thermocouple terminal	0000 basic type	0016
ES3602-0010-0017	ES terminal 12 mm, pluggable connection level	3602 2-channel voltage measurement	0010 high-precision version	0017
CU2008-0000-0000	CU device	2008 8-port fast ethernet switch	0000 basic type	0000

#### Notes

- The elements mentioned above result in the **technical designation**. EL3314-0000-0016 is used in the example below.
- EL3314-0000 is the order identifier, in the case of "-0000" usually abbreviated to EL3314. "-0016" is the EtherCAT revision.
- The **order identifier** is made up of
  - family key (EL, EP, CU, ES, KL, CX, etc.)
  - type (3314)
  - version (-0000)
- The **revision** -0016 shows the technical progress, such as the extension of features with regard to the EtherCAT communication, and is managed by Beckhoff.  
In principle, a device with a higher revision can replace a device with a lower revision, unless specified otherwise, e.g. in the documentation.  
Associated and synonymous with each revision there is usually a description (ESI, EtherCAT Slave Information) in the form of an XML file, which is available for download from the Beckhoff web site.  
From 2014/01 the revision is shown on the outside of the IP20 terminals, see Fig. "EL5021 EL terminal, standard IP20 IO device with batch number and revision ID (since 2014/01)".
- The type, version and revision are read as decimal numbers, even if they are technically saved in hexadecimal.

### 8.3.2 Version identification of IP67 modules

The serial number/ data code for Beckhoff IO devices is usually the 8-digit number printed on the device or on a sticker. The serial number indicates the configuration in delivery state and therefore refers to a whole production batch, without distinguishing the individual modules of a batch.

Structure of the serial number: **KK YY FF HH**

KK - week of production (CW, calendar week)

YY - year of production

FF - firmware version

HH - hardware version

Example with serial number 12 06 3A 02:

12 - production week 12

06 - production year 2006

3A - firmware version 3A

02 - hardware version 02

Exceptions can occur in the **IP67 area**, where the following syntax can be used (see respective device documentation):

Syntax: D ww yy x y z u

D - prefix designation

ww - calendar week

yy - year

x - firmware version of the bus PCB

y - hardware version of the bus PCB

z - firmware version of the I/O PCB

u - hardware version of the I/O PCB

Example: D.22081501 calendar week 22 of the year 2008 firmware version of bus PCB: 1 hardware version of bus PCB: 5 firmware version of I/O PCB: 0 (no firmware necessary for this PCB) hardware version of I/O PCB: 1

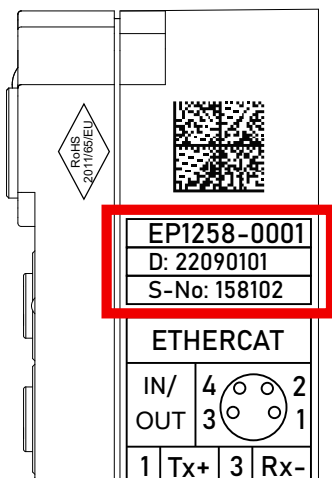

Fig. 12: EP1258-00001 IP67 EtherCAT Box with batch number/DateCode 22090101 and unique serial number 158102

### 8.3.3 Beckhoff Identification Code (BIC)

The Beckhoff Identification Code (BIC) is increasingly being applied to Beckhoff products to uniquely identify the product. The BIC is represented as a Data Matrix Code (DMC, code scheme ECC200), the content is based on the ANSI standard MH10.8.2-2016.

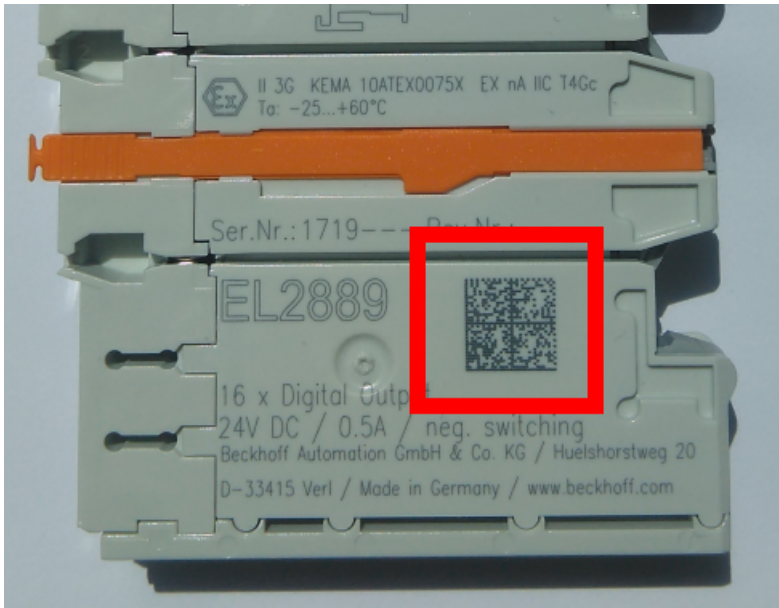

Fig. 13: BIC as data matrix code (DMC, code scheme ECC200)

The BIC will be introduced step by step across all product groups.

Depending on the product, it can be found in the following places:

- on the packaging unit
- directly on the product (if space suffices)
- on the packaging unit and the product

The BIC is machine-readable and contains information that can also be used by the customer for handling and product management.

Each piece of information can be uniquely identified using the so-called data identifier (ANSI MH10.8.2-2016). The data identifier is followed by a character string. Both together have a maximum length according to the table below. If the information is shorter, spaces are added to it.

Following information is possible, positions 1 to 4 are always present, the other according to need of production:

Position	Type of information	Explanation	Data identifier	Number of digits incl. data identifier	Example
1	Beckhoff order number	<b>Beckhoff order number</b>	1P	8	<b>1P</b> 072222
2	Beckhoff Traceability Number (BTN)	<b>Unique serial number, see note below</b>	SBTN	12	<b>SBTN</b> k4p562d7
3	Article description	<b>Beckhoff article description, e.g. EL1008</b>	1K	32	<b>1K</b> EL1809
4	Quantity	<b>Quantity in packaging unit, e.g. 1, 10, etc.</b>	Q	6	<b>Q1</b>
5	Batch number	Optional: Year and week of production	2P	14	<b>2P</b> 401503180016
6	ID/serial number	Optional: Present-day serial number system, e.g. with safety products	51S	12	<b>51S</b> 678294
7	Variant number	Optional: Product variant number on the basis of standard products	30P	32	<b>30P</b> F971, 2*K183
...					

Further types of information and data identifiers are used by Beckhoff and serve internal processes.

### Structure of the BIC

Example of composite information from positions 1 to 4 and with the above given example value on position 6. The data identifiers are highlighted in bold font:

**1P**072222**SBTN**k4p562d7**1K**EL1809 **Q1** **51S**678294

Accordingly as DMC:



Fig. 14: Example DMC **1P**072222**SBTN**k4p562d7**1K**EL1809 **Q1** **51S**678294

### BTN

An important component of the BIC is the Beckhoff Traceability Number (BTN, position 2). The BTN is a unique serial number consisting of eight characters that will replace all other serial number systems at Beckhoff in the long term (e.g. batch designations on IO components, previous serial number range for safety products, etc.). The BTN will also be introduced step by step, so it may happen that the BTN is not yet coded in the BIC.

### NOTICE

This information has been carefully prepared. However, the procedure described is constantly being further developed. We reserve the right to revise and change procedures and documentation at any time and without prior notice. No claims for changes can be made from the information, illustrations and descriptions in this information.

### 8.3.4 Electronic access to the BIC (eBIC)

#### Electronic BIC (eBIC)

The Beckhoff Identification Code (BIC) is applied to the outside of Beckhoff products in a visible place. If possible, it should also be electronically readable.

The interface that the product can be electronically addressed by is crucial for the electronic readout.

#### EtherCAT devices (IP20, IP67)

All Beckhoff EtherCAT devices have an ESI-EEPROM which contains the EtherCAT identity with the revision number. The EtherCAT slave information, also colloquially known as the ESI/XML configuration file for the EtherCAT master, is stored in it. See the corresponding chapter in the EtherCAT system manual ([Link](#)) for the relationships.

Beckhoff also stores the eBIC in the ESI-EEPROM. The eBIC was introduced into Beckhoff IO production (terminals, box modules) in 2020; as of 2023, implementation is largely complete.

The user can electronically access the eBIC (if present) as follows:

- With all EtherCAT devices, the EtherCAT master (TwinCAT) can read the eBIC from the ESI-EEPROM
  - From TwinCAT 3.1 build 4024.11, the eBIC can be displayed in the online view.
  - To do this, check the "Show Beckhoff Identification Code (BIC)" checkbox under EtherCAT → Advanced Settings → Diagnostics:

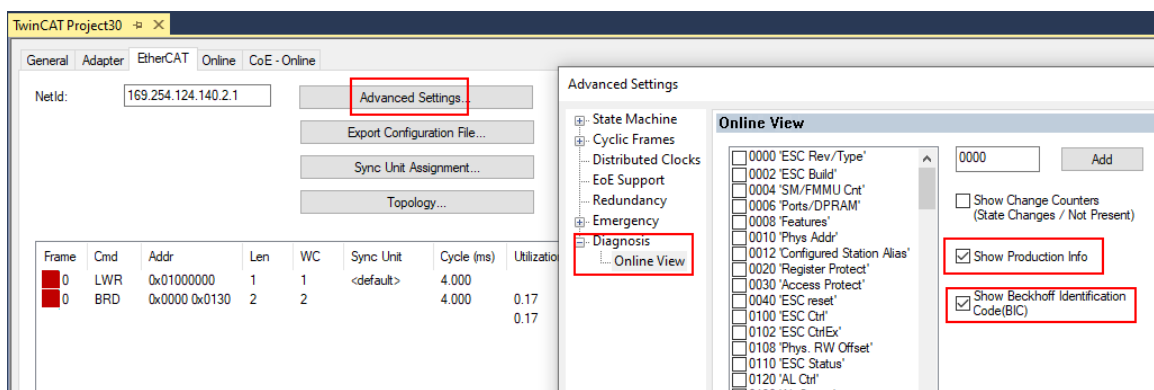

- The BTN and its contents are then displayed:

No	Addr	Name	State	CRC	Fw	Hw	Production Data	ItemNo	BTN	Description	Quantity	BatchNo	SerialNo
1	1001	Term 1 (EK1100)	OP	0,0	0	0	---						
2	1002	Term 2 (EL1018)	OP	0,0	0	0	2020 KW36 Fr	072222	k4p562d7	EL1809	1		678294
3	1003	Term 3 (EL3204)	OP	0,0	7	6	2012 KW24 Sa						
4	1004	Term 4 (EL2004)	OP	0,0	0	0	---	072223	k4p562d7	EL2004	1		678295
5	1005	Term 5 (EL1008)	OP	0,0	0	0	---						
6	1006	Term 6 (EL2008)	OP	0,0	0	12	2014 KW14 Mo						
7	1007	Term 7 (EK1110)	OP	0	1	8	2012 KW25 Mo						

- Note: As shown in the figure, the production data HW version, FW version, and production date, which have been programmed since 2012, can also be displayed with "Show production info".
- Access from the PLC: From TwinCAT 3.1. build 4024.24, the functions *FB\_EcReadBIC* and *FB\_EcReadBTN* for reading into the PLC are available in the Tc2\_EtherCAT library from v3.3.19.0.
- EtherCAT devices with a CoE directory may also have the object 0x10E2:01 to display their own eBIC, which can also be easily accessed by the PLC:

- The device must be in PREOP/SAFEOP/OP for access:

Index	Name	Flags	Value
1000	Device type	RO	0x015E1389 (22942601)
1008	Device name	RO	ELM3704-0000
1009	Hardware version	RO	00
100A	Software version	RO	01
100B	Bootloader version	RO	J0.1.27.0
1011:0	Restore default parameters	RO	> 1 <
1018:0	Identity	RO	> 4 <
10E2:0	Manufacturer-specific Identification C...	RO	> 1 <
10E2:01	SubIndex 001	RO	1P158442SBTN0008jckp1KELM3704 Q1 2P482001000016
10F0:0	Backup parameter handling	RO	> 1 <
10F3:0	Diagnosis History	RO	> 21 <
10F8	Actual Time Stamp	RO	0x170bfb277e

- The object 0x10E2 will be preferentially introduced into stock products in the course of necessary firmware revision.
- From TwinCAT 3.1. build 4024.24, the functions *FB\_EcCoEReadBIC* and *FB\_EcCoEReadBTN* for reading into the PLC are available in the *Tc2\_EtherCAT* library from v3.3.19.0
- The following auxiliary functions are available for processing the BIC/BTN data in the PLC in *Tc2\_Uilities* as of TwinCAT 3.1 build 4024.24
  - *F\_SplitBIC*: The function splits the Beckhoff Identification Code (BIC) *sBICValue* into its components using known identifiers and returns the recognized substrings in the *ST\_SplittedBIC* structure as a return value
  - *BIC\_TO\_BTN*: The function extracts the BTN from the BIC and returns it as a return value
- Note: If there is further electronic processing, the BTN is to be handled as a string(8); the identifier "SBTN" is not part of the BTN.
- Technical background  
The new BIC information is written as an additional category in the ESI-EEPROM during device production. The structure of the ESI content is largely dictated by the ETG specifications, therefore the additional vendor-specific content is stored using a category in accordance with the ETG.2010. ID 03 tells all EtherCAT masters that they may not overwrite these data in the event of an update or restore the data after an ESI update.  
The structure follows the content of the BIC, see here. The EEPROM therefore requires approx. 50..200 bytes of memory.
- Special cases
  - If multiple hierarchically arranged ESCs are installed in a device, only the top-level ESC carries the eBIC information.
  - If multiple non-hierarchically arranged ESCs are installed in a device, all ESCs carry the eBIC information.
  - If the device consists of several sub-devices which each have their own identity, but only the top-level device is accessible via EtherCAT, the eBIC of the top-level device is located in the CoE object directory 0x10E2:01 and the eBICs of the sub-devices follow in 0x10E2:nn.



## 8.4 Support and Service

Beckhoff and their partners around the world offer comprehensive support and service, making available fast and competent assistance with all questions related to Beckhoff products and system solutions.

### Beckhoff's branch offices and representatives

Please contact your Beckhoff branch office or representative for local support and service on Beckhoff products!

The addresses of Beckhoff's branch offices and representatives round the world can be found on her internet pages: [www.beckhoff.com](http://www.beckhoff.com)

You will also find further documentation for Beckhoff components there.

### Support

The Beckhoff Support offers you comprehensive technical assistance, helping you not only with the application of individual Beckhoff products, but also with other, wide-ranging services:

- support
- design, programming and commissioning of complex automation systems
- and extensive training program for Beckhoff system components

Hotline: +49 5246 963 157  
e-mail: [support@beckhoff.com](mailto:support@beckhoff.com)  
web: [www.beckhoff.com/support](http://www.beckhoff.com/support)

### Service

The Beckhoff Service Center supports you in all matters of after-sales service:

- on-site service
- repair service
- spare parts service
- hotline service

Hotline: +49 5246 963 460  
e-mail: [service@beckhoff.com](mailto:service@beckhoff.com)  
web: [www.beckhoff.com/service](http://www.beckhoff.com/service)

### Headquarters Germany

Beckhoff Automation GmbH & Co. KG

Hülshorstweg 20  
33415 Verl  
Germany

Phone: +49 5246 963 0  
e-mail: [info@beckhoff.com](mailto:info@beckhoff.com)  
web: [www.beckhoff.com](http://www.beckhoff.com)



Beckhoff Automation GmbH & Co. KG  
Hülshorstweg 20  
33415 Verl  
Germany  
Phone: +49 5246 9630  
[info@beckhoff.com](mailto:info@beckhoff.com)  
[www.beckhoff.com](http://www.beckhoff.com)