

Documentation | EN

# EP7041

Stepper motor modules





# Table of contents

<b>1</b>	<b>Foreword</b> .....	<b>5</b>
1.1	Notes on the documentation .....	5
1.2	Safety instructions .....	6
1.3	Documentation issue status .....	7
<b>2</b>	<b>EtherCAT Box - Introduction</b> .....	<b>9</b>
<b>3</b>	<b>Product overview</b> .....	<b>11</b>
3.1	Introduction .....	12
3.1.1	EP7041-0002, EP7041 .....	12
3.1.2	EP7041-2002 .....	13
3.1.3	EP7041-3002, EP7041-3102 .....	14
3.2	Technical data .....	15
3.3	Scope of supply.....	17
3.4	Process image .....	18
<b>4</b>	<b>Installation</b> .....	<b>21</b>
4.1	Mounting .....	21
4.1.1	Dimensions .....	21
4.1.2	Fixing.....	22
4.1.3	Tightening torques for plug connectors.....	22
4.2	Connection .....	23
4.2.1	Supply voltages.....	23
4.2.2	EtherCAT .....	26
4.2.3	Stepper motor, brake, encoder .....	28
4.3	ATEX notes .....	32
4.3.1	ATEX - Special conditions.....	32
4.3.2	BG2000 - EtherCAT Box protection enclosures.....	33
4.3.3	ATEX Documentation.....	34
4.4	Disposal .....	35
<b>5</b>	<b>Commissioning/Configuration</b> .....	<b>36</b>
5.1	Integrating into a TwinCAT project.....	36
5.2	Integration into the NC configuration.....	37
5.3	Configuration of the main parameters .....	42
5.4	Basic principles for the Positioning Interface .....	51
5.4.1	Predefined PDO Assignment .....	51
5.4.2	Parameter set.....	51
5.4.3	Information and diagnostic data .....	54
5.4.4	States of the internal state machine.....	55
5.4.5	Standard sequence of a travel command .....	56
5.4.6	Start types .....	57
5.4.7	Modulo - general description.....	60
5.4.8	Examples of two travel commands with a dynamic change of the target position .....	64
5.5	Application example .....	66
5.6	Restore the delivery state .....	71
<b>6</b>	<b>CoE objects EP7041-0002, EP7041-1002, EP7041-2002</b> .....	<b>72</b>

6.1	Object description and parameterization.....	72
6.1.1	Objects for commissioning .....	73
6.1.2	Standardobjekte (0x1000 .. 0x1FFF) .....	78
6.1.3	Profile-specific objects (0x6000 .. 0xFFFF).....	90
<b>7</b>	<b>CoE objects EP7041-3002, EP7041-3102 .....</b>	<b>97</b>
7.1	Object description and parameterization.....	97
7.1.1	Objects for commissioning .....	98
7.1.2	Standard objects (0x1000 .. 0x1FFF).....	103
7.1.3	Profile-specific objects (0x6000 .. 0xFFFF).....	115
<b>8</b>	<b>Appendix .....</b>	<b>121</b>
8.1	General operating conditions .....	121
8.2	Accessories .....	122
8.3	Version identification of EtherCAT devices .....	123
8.3.1	General notes on marking.....	123
8.3.2	Version identification of IP67 modules .....	124
8.3.3	Beckhoff Identification Code (BIC).....	125
8.3.4	Electronic access to the BIC (eBIC).....	127
8.4	Support and Service.....	129

# 1 Foreword

## 1.1 Notes on the documentation

### Intended audience

This description is only intended for the use of trained specialists in control and automation engineering who are familiar with the applicable national standards.

It is essential that the documentation and the following notes and explanations are followed when installing and commissioning these components.

The qualified personnel is obliged to always use the currently valid documentation.

The responsible staff must ensure that the application or use of the products described satisfy all the requirements for safety, including all the relevant laws, regulations, guidelines and standards.

### Disclaimer

The documentation has been prepared with care. The products described are, however, constantly under development.

We reserve the right to revise and change the documentation at any time and without prior announcement.

No claims for the modification of products that have already been supplied may be made on the basis of the data, diagrams and descriptions in this documentation.

### Trademarks

Beckhoff®, TwinCAT®, TwinCAT/BSD®, TC/BSD®, EtherCAT®, EtherCAT G®, EtherCAT G10®, EtherCAT P®, Safety over EtherCAT®, TwinSAFE®, XFC®, XTS® and XPlanar® are registered trademarks of and licensed by Beckhoff Automation GmbH. Other designations used in this publication may be trademarks whose use by third parties for their own purposes could violate the rights of the owners.

### Patent Pending

The EtherCAT Technology is covered, including but not limited to the following patent applications and patents: EP1590927, EP1789857, EP1456722, EP2137893, DE102015105702 with corresponding applications or registrations in various other countries.



EtherCAT® is registered trademark and patented technology, licensed by Beckhoff Automation GmbH, Germany.

### Copyright

© Beckhoff Automation GmbH & Co. KG, Germany.

The reproduction, distribution and utilization of this document as well as the communication of its contents to others without express authorization are prohibited.

Offenders will be held liable for the payment of damages. All rights reserved in the event of the grant of a patent, utility model or design.

## 1.2 Safety instructions

### Safety regulations

Please note the following safety instructions and explanations!  
Product-specific safety instructions can be found on following pages or in the areas mounting, wiring, commissioning etc.

### Exclusion of liability

All the components are supplied in particular hardware and software configurations appropriate for the application. Modifications to hardware or software configurations other than those described in the documentation are not permitted, and nullify the liability of Beckhoff Automation GmbH & Co. KG.

### Personnel qualification

This description is only intended for trained specialists in control, automation and drive engineering who are familiar with the applicable national standards.

### Signal words

The signal words used in the documentation are classified below. In order to prevent injury and damage to persons and property, read and follow the safety and warning notices.

### Personal injury warnings

**⚠ DANGER**

Hazard with high risk of death or serious injury.

**⚠ WARNING**

Hazard with medium risk of death or serious injury.

**⚠ CAUTION**

There is a low-risk hazard that could result in medium or minor injury.

### Warning of damage to property or environment

**NOTICE**

The environment, equipment, or data may be damaged.

### Information on handling the product



This information includes, for example:  
recommendations for action, assistance or further information on the product.

### 1.3 Documentation issue status

Version	Comment
2.8	<ul style="list-style-type: none"> <li>• Technical data updated</li> </ul>
2.7	<ul style="list-style-type: none"> <li>• Connection chapter updated</li> </ul>
2.6	<ul style="list-style-type: none"> <li>• Technical data updated</li> <li>• Pin assignment updated</li> </ul>
2.5	<ul style="list-style-type: none"> <li>• Dimensions updated</li> <li>• CoE objects updated</li> </ul>
2.4	<ul style="list-style-type: none"> <li>• Front page updated</li> </ul>
2.3	<ul style="list-style-type: none"> <li>• Technical data updated</li> </ul>
2.2.0	<ul style="list-style-type: none"> <li>• Update safety instructions</li> <li>• Update chapter <i>Mounting</i></li> </ul>
2.1.0	<ul style="list-style-type: none"> <li>• EP7041-3102 added</li> </ul>
2.0.0	<ul style="list-style-type: none"> <li>• Migration</li> </ul>
1.7.0	<ul style="list-style-type: none"> <li>• Preface updated</li> <li>• Chapter on <i>Nut torques for connectors</i> updated</li> <li>• Chapter on <i>EtherCAT connection</i> updated</li> <li>• Chapter <i>Signal cable</i> updated</li> <li>• Chapter <i>Accessories</i> updated</li> <li>• Chapter <i>Line losses</i> updated</li> </ul>
1.6.0	<ul style="list-style-type: none"> <li>• Power connection updated</li> </ul>
1.5.0	<ul style="list-style-type: none"> <li>• Technical data updated</li> </ul>
1.4.0	<ul style="list-style-type: none"> <li>• Technical data updated</li> </ul>
1.3.0	<ul style="list-style-type: none"> <li>• Technical data updated</li> <li>• Object descriptions updated</li> <li>• Basics about Position Interface added</li> <li>• Chapter <i>Accessories</i> updated</li> <li>• Chapter on <i>Nut torque for connectors</i> updated</li> <li>• Chapter <i>Power connection</i> updated</li> </ul>
1.2.0	<ul style="list-style-type: none"> <li>• Chapter <i>Configuration of the main parameters</i> updated</li> <li>• Chapter <i>Accessories</i> added</li> </ul>
1.1.0	<ul style="list-style-type: none"> <li>• Technical data updated</li> <li>• EP7041-2002 and EP7041-3002 added</li> <li>• Overview of EtherCAT cables extended</li> <li>• Overview of the signal cables updated</li> <li>• Description of the power connection updated</li> <li>• ATEX notes added</li> <li>• Extended temperature range for activated modules documented</li> </ul>
1.0.0	<ul style="list-style-type: none"> <li>• Chapter on commissioning and configuration revised</li> </ul>
0.6	<ul style="list-style-type: none"> <li>• EP7041-1002 added</li> <li>• Object description updated</li> <li>• Nut torque for connectors added</li> <li>• Overview of the signal cables added</li> </ul>
0.5	<ul style="list-style-type: none"> <li>• First preliminary version for EP7041-0002</li> </ul>

**Firmware and hardware versions**

This documentation refers to the firmware and hardware version that was applicable at the time the documentation was written.

The module features are continuously improved and developed further. Modules having earlier production statuses cannot have the same properties as modules with the latest status. However, existing properties are retained and are not changed, so that older modules can always be replaced with new ones.

The firmware and hardware version (delivery state) can be found in the batch number (D-number) printed on the side of the EtherCAT Box.

**Syntax of the batch number (D-number)**

D: WW YY FF HH

WW - week of production (calendar week)

YY - year of production

FF - firmware version

HH - hardware version

Example with D no. 29 10 02 01:

29 - week of production 29

10 - year of production 2010

02 - firmware version 02

01 - hardware version 01

Further information on this topic: [Version identification of EtherCAT devices \[► 123\]](#).



## 2 EtherCAT Box - Introduction

The EtherCAT system has been extended with EtherCAT Box modules with protection class IP67. Through the integrated EtherCAT interface the modules can be connected directly to an EtherCAT network without an additional Coupler Box. The high-performance of EtherCAT is thus maintained into each module.

The extremely low dimensions of only 126 x 30 x 26.5 mm (h x w x d) are identical to those of the Fieldbus Box extension modules. They are thus particularly suitable for use where space is at a premium. The small mass of the EtherCAT modules facilitates applications with mobile I/O interface (e.g. on a robot arm). The EtherCAT connection is established via screened M8 connectors.

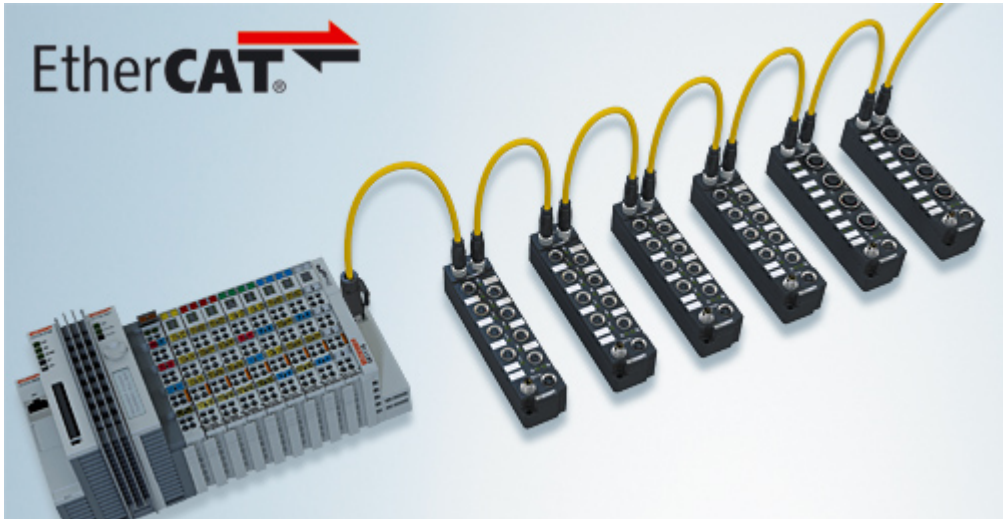

Fig. 1: EtherCAT Box Modules within an EtherCAT network

The robust design of the EtherCAT Box modules enables them to be used directly at the machine. Control cabinets and terminal boxes are now no longer required. The modules are fully sealed and therefore ideally prepared for wet, dirty or dusty conditions.

Pre-assembled cables significantly simplify EtherCAT and signal wiring. Very few wiring errors are made, so that commissioning is optimized. In addition to pre-assembled EtherCAT, power and sensor cables, field-configurable connectors and cables are available for maximum flexibility. Depending on the application, the sensors and actuators are connected through M8 or M12 connectors.

The EtherCAT modules cover the typical range of requirements for I/O signals with protection class IP67:

- digital inputs with different filters (3.0 ms or 10  $\mu$ s)
- digital outputs with 0.5 or 2 A output current
- analog inputs and outputs with 16 bit resolution
- Thermocouple and RTD inputs
- Stepper motor modules

XFC (eXtreme Fast Control Technology) modules, including inputs with time stamp, are also available.



Fig. 2: EtherCAT Box with M8 connections for sensors/actuators



Fig. 3: EtherCAT Box with M12 connections for sensors/actuators

---

**● Basic EtherCAT documentation**

**i** You will find a detailed description of the EtherCAT system in the Basic System Documentation for EtherCAT, which is available for download from our website ([www.beckhoff.com](http://www.beckhoff.com)) under Downloads.

---

### 3 Product overview

The following table shows the products described in this documentation and the main distinguishing features.

Module	Output current for stepper motor	Integrated connection for motor supply	Comment
<a href="#">EP7041-0002</a> [▶ 12]	2 x 3.5 A rated current, 2 x 5.0 A peak current	M12, female	<ul style="list-style-type: none"> <li>Designed for particularly quiet and precise motor operation.</li> </ul>
<a href="#">EP7041-1002</a> [▶ 12]	2 x 1.0 A rated current, 2 x 1.5 A peak current	M12, female	<ul style="list-style-type: none"> <li>Designed for particularly quiet and precise motor operation.</li> <li>Smaller output current for stepper motors with lower power consumption.</li> </ul>
<a href="#">EP7041-2002</a> [▶ 13]	2 x 3.5 A rated current, 2 x 5.0 A peak current	M12, male	<ul style="list-style-type: none"> <li>Designed for particularly quiet and precise motor operation.</li> <li>Integrated connector for feeding the motor supply build with pins (male).</li> </ul>
<a href="#">EP7041-3002</a> [▶ 14]	2 x 3.5 A rated current, 2 x 5.0 A peak current	M12, male	<ul style="list-style-type: none"> <li>Designed for higher velocities.</li> <li>Integrated connector for feeding the motor supply build with pins (male).</li> </ul>
<a href="#">EP7041-3102</a> [▶ 14]	2 x 3.5 A rated current, 2 x 5.0 A peak current	M12, male	<ul style="list-style-type: none"> <li>Designed for higher velocities.</li> <li>Integrated connector for feeding the motor supply build with pins (male).</li> <li>5 V<sub>DC</sub> encoder supply</li> </ul>

### 3.1 Introduction

#### 3.1.1 EP7041-0002, EP7041

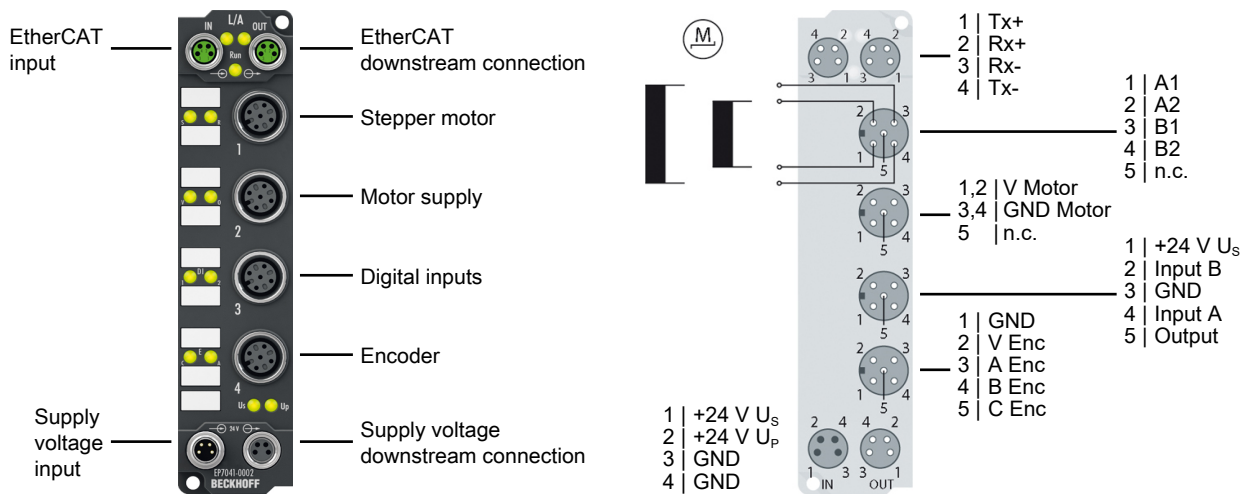

#### Stepper Motor modules with interface for incremental encoder

The EP7041-0002 and EP7041-1002 EtherCAT Box Modules are intended for the direct connection of different stepper motors.

Two versions are available:

- EP7041-0002: 2 x 3.5 A rated current, (2 x 5.0 A peak current)
- EP7041-1002: 2 x 1.0 A rated current, (2 x 1.5 A peak current)

The PWM output stages for two motor coils with compact design are located in the module together with two inputs for limit switches and cover a wide voltage and current range.

A servo axis can easily be realized by connecting an incremental encoder.

Two digital inputs and a digital output (0.5 A) enable connection of limit switches and a motor brake.

The modules can be adjusted to the motor and the application by changing various parameters. 64-fold micro-stepping ensures particularly quiet and precise motor operation.

#### Quick links

- [Installation](#) [► 21]
- [Configuration](#) [► 36]
- [CoE objects](#) [► 72]

### 3.1.2 EP7041-2002

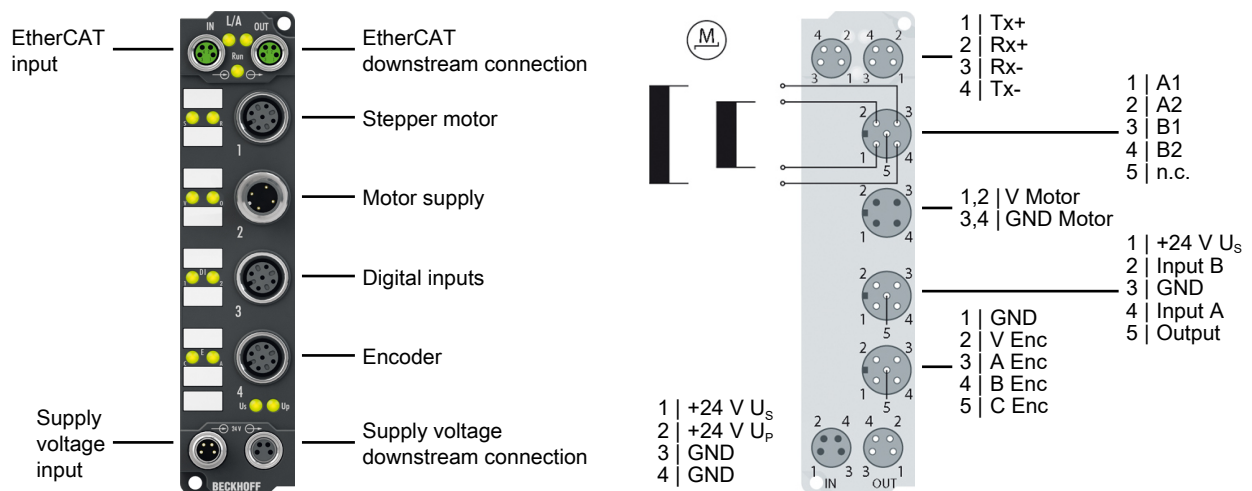

#### Stepper Motor modules with interface for incremental encoder

The EP7041-2002 EtherCAT Box is designed for direct connection of different stepper motors.

The PWM output stages for two motor coils with compact design are located in the module together with two inputs for limit switches and cover a wide voltage and current range.

A servo axis can easily be realized by connecting an incremental encoder.

Two digital inputs and a digital output (0.5 A) enable connection of limit switches and a motor brake.

The external motor is fed via an integrated plug.

The EP7041-2002 can be adjusted to the motor and the application by changing various parameters. 64-fold micro-stepping ensures particularly quiet and precise motor operation.

#### Quick links

- [Installation \[▶ 21\]](#)
- [Configuration \[▶ 36\]](#)
- [CoE objects \[▶ 72\]](#)

### 3.1.3 EP7041-3002, EP7041-3102

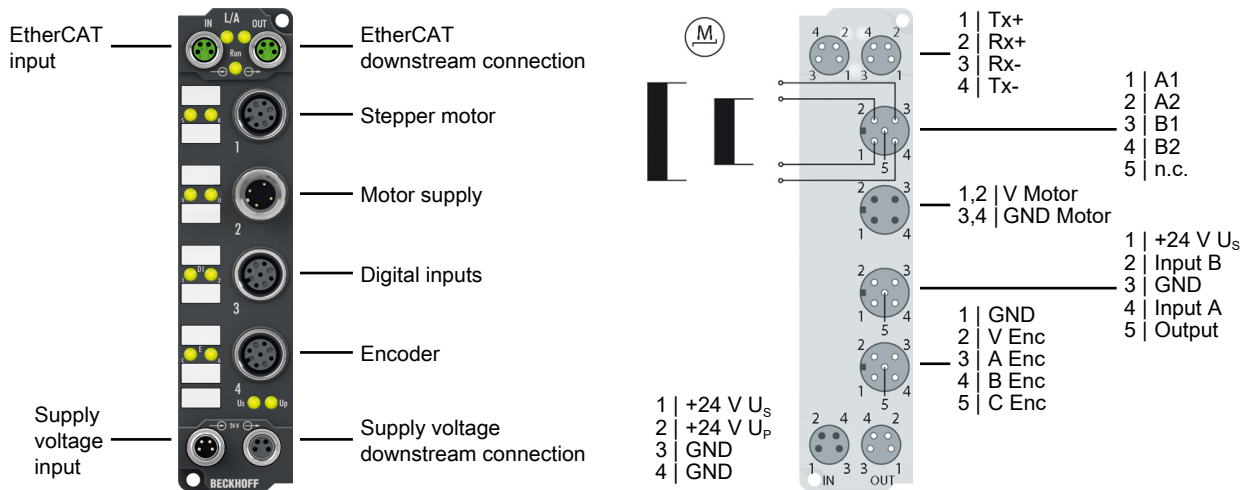

#### Stepper Motor modules with interface for incremental encoder

The EP7041-3002 and EP7041-3102 EtherCAT Box Modules are designed for direct connection of different stepper motors. The PWM output stages for two motor coils with compact design are located in the module together with two inputs for limit switches and cover a wide voltage and current range.

A servo axis can easily be realized by connecting an incremental encoder. The modules supply the incremental encoder with:

- EP7041-3002: 24 V<sub>DC</sub>
- EP7041-3102: 5 V<sub>DC</sub>

Two digital inputs and a digital output (0.5 A) enable connection of limit switches and a motor brake.

The external motor is fed via an integrated plug.

EP7041-3002 and EP7041-3102 are designed for higher velocities and can be adjusted to the motor and the application by changing various parameters.

#### Quick links

- [Installation \[► 21\]](#)
- [Configuration \[► 36\]](#)
- [CoE objects \[► 97\]](#)

## 3.2 Technical data

All values are typical values over the entire temperature range, unless stated otherwise.

EtherCAT	
Connection	2 x M8 socket, 4-pin, A-coded, shielded
Electrical isolation	500 V
Distributed Clocks	yes

Supply voltages	
Connection	Input: M8 connector, 4-pin, A-coded Downstream connection: M8 socket, 4-pin, A-coded
$U_S$ nominal voltage	24 V <sub>DC</sub> (-15 % / +20 %)
$U_S$ sum current: $I_{S,sum}$	max. 4 A
Current consumption from $U_S$	120 mA
Rated voltage $U_P$	24 V <sub>DC</sub> (-15 % / +20 %)
$U_P$ sum current: $I_{P,sum}$	max. 4 A
Current consumption from $U_P$	= current consumption of connected devices: <ul style="list-style-type: none"> <li>• Encoder</li> <li>• Brake</li> </ul>

Motor	EP7041 -0002	EP7041 -1002	EP7041 -2002	EP7041 -3002	EP7041 -3102
Motor type	2-phase stepper motor, unipolar or bipolar				
Connection	M12 socket				
Cable length	max. 30 m				
Motor supply	max. 48 V <sub>DC</sub> , not protected against polarity reversal				
Motor supply connection	M12 socket "2" [► 29]		M12 plug "2" [► 29]		
Nominal current per phase	3.5 A	1.0 A	3.5 A		
Peak current per phase	5.0 A at 50 °C	1.5 A	5.0 A at 50 °C		
Microstepping	max. 64 microsteps			max. 256 microsteps	
Step frequency	max. 32,000 full steps per second (configurable)				
Current controller frequency	approx. 30 kHz				
Driver circuit	2 x H-bridge				
Protective functions	Overload protection, short-circuit protection				

Brake output	
Number	1
Connection	M12 socket
Cable length	max. 30 m
Output voltage	24 V <sub>DC</sub> from $U_P$
Output current	0.5 A, short-circuit proof

Digital inputs	
Number	2
Connection	M12 socket
Cable length	max. 30 m
Signal voltage "0"	-3 ... 2 V
Signal voltage "1"	3.5 ... 28 V
Input filter	1 $\mu$ s
Input current	5 mA
Sensor power supply (pin 1)	24 V <sub>DC</sub> from U <sub>P</sub> , max. 0.5 A, short-circuit proof

Encoder	EP7041 -0002	EP7041 -1002	EP7041 -2002	EP7041 -3002	EP7041 -3102
Encoder type	Incremental encoder with single-ended output drivers: <ul style="list-style-type: none"> <li>• Push-pull</li> <li>• Open collector <sup>1)</sup></li> </ul>				
Connection	M12 socket				
Cable length	max. 30 m				
Signals	A, B, C (reference pulse/zero pulse)				
Low level	-3 ... 2 V <sub>DC</sub>				max. 1 V <sub>DC</sub> <sup>2)</sup>
High level	3.5 ... 28 V <sub>DC</sub>				2.5 ... 28 V <sub>DC</sub> <sup>2)</sup>
Supply voltage output	24 V <sub>DC</sub> from U <sub>P</sub> max. 0.5 A, not short-circuit proof				5 V <sub>DC</sub>
Pulse frequency	maximum 400,000 increments/s (quadruple evaluation)				

<sup>1)</sup> Pull-up resistor required

<sup>2)</sup> These levels apply from hardware version 07. Up to hardware version 06 the following levels apply:

- Low level: -3 ... 2 V<sub>DC</sub>
- High level: 3.5 ... 28 V<sub>DC</sub>

Housing data	
Dimensions W x H x D	30 mm x 126 mm x 26.5 mm (without connectors)
Weight	approx. 165 g
Installation position	<ul style="list-style-type: none"> <li>• Up to 40 °C ambient temperature: variable</li> <li>• Over 40 °C ambient temperature: distance between 2 stepper motor modules at least 20 mm</li> </ul>
Material	PA6 (polyamide)

Environmental conditions	
Ambient temperature during operation	-25 ... +60 °C 0 ... +55 °C according to ATEX
Ambient temperature during storage	-40 ... +85 °C
Vibration resistance, shock resistance	conforms to EN 60068-2-6 / EN 60068-2-27 <a href="#">Additional tests [► 17]</a>
EMC immunity / emission	conforms to EN 61000-6-2 / EN 61000-6-4
Protection rating	IP65, IP66, IP67 (conforms to EN 60529)



Approvals/markings	
Approvals/markings *)	ATEX [▶ 32], CE

\*) Real applicable approvals/markings see type plate on the side (product marking).

**Additional tests**

The devices have undergone the following additional tests:

Test	Explanation
Vibration	10 frequency sweeps in 3 axes
	5 Hz < f < 60 Hz displacement 0.35 mm, constant amplitude
	60.1 Hz < f < 500 Hz acceleration 5 g, constant amplitude
Shocks	1000 shocks in each direction, in 3 axes
	35 g, 11 ms

### 3.3 Scope of supply

Make sure that the following components are included in the scope of delivery:

- 1x EtherCAT Box EP7041
- 1x protective cap for supply voltage input, M8, transparent (pre-assembled)
- 1x protective cap for supply voltage output, M8, black (pre-assembled)
- 2x protective cap for EtherCAT socket, M8, green (pre-assembled)
- 10x labels, blank (1 strip of 10)

**i Pre-assembled protective caps do not ensure IP67 protection**

Protective caps are pre-assembled at the factory to protect connectors during transport. They may not be tight enough to ensure IP67 protection.

Ensure that the protective caps are correctly seated to ensure IP67 protection.

### 3.4 Process image

The TwinCAT System Manager displays the EP7041 data in a tree structure.

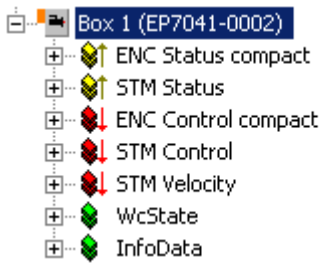

The tree shows

- ENC Status compact: encoder status
- STM Status: Stepper Motor Status
- ENC Control compact: Encoder Control
- STM Control: Stepper Motor Control
- STM Velocity: Stepper Motor Velocity

#### ENC Status compact

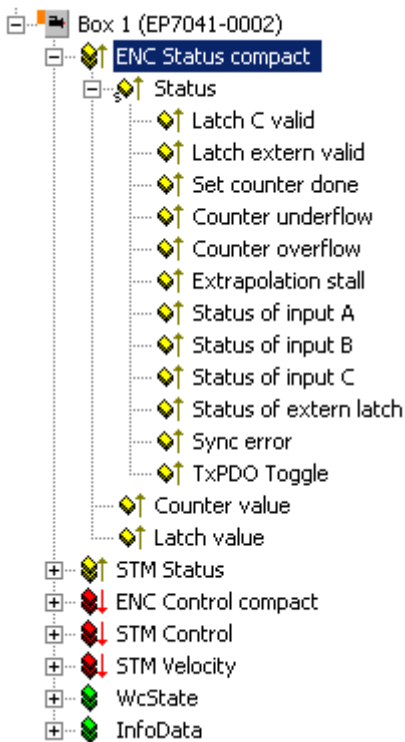

The status information for the encoder can be found under **ENC Status compact**.

**STM Status**

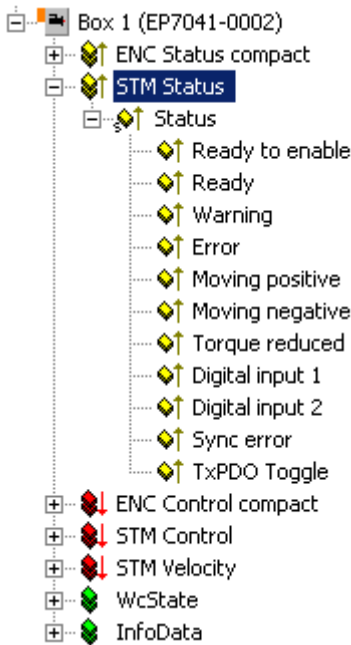

The status information for the stepper motor can be found under **STM Status**.

**ENC Control compact**

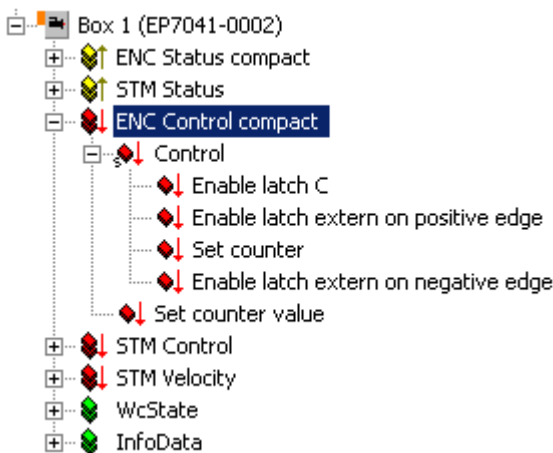

The control parameters for the encoder can be found under **ENC Control compact**.

**STM Control**

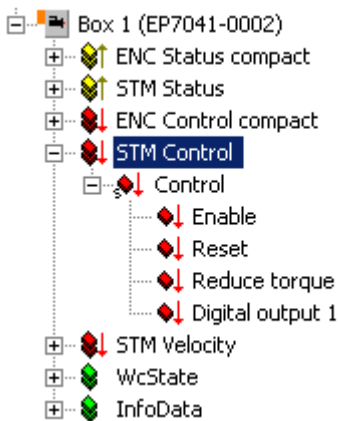

The control parameters for the stepper motor can be found under **STM Control**.

## STM Velocity

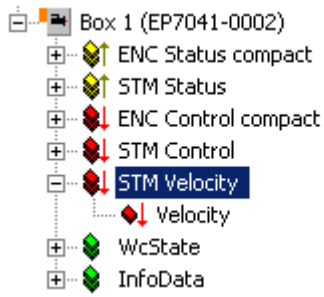

The velocity settings for the stepper motor can be found under **STM Velocity**.

## 4 Installation

### 4.1 Mounting

#### 4.1.1 Dimensions

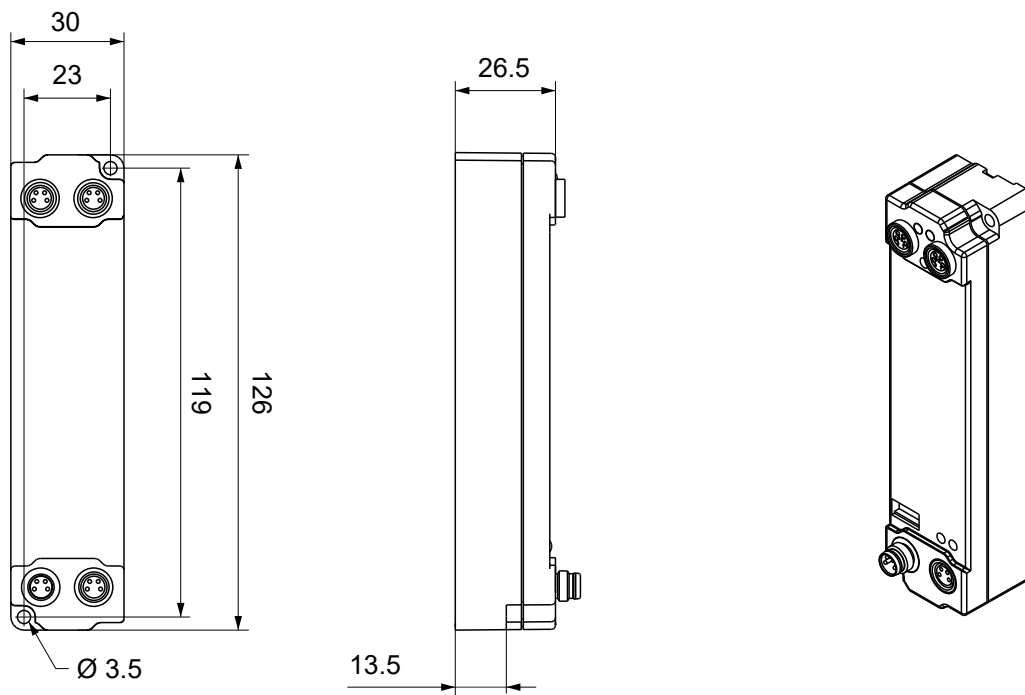

All dimensions are given in millimeters.  
The drawing is not true to scale.

#### Housing features

Housing material	PA6 (polyamide)
Sealing compound	polyurethane
Mounting	two mounting holes $\varnothing 3.5$ mm for M3
Metal parts	brass, nickel-plated
Contacts	CuZn, gold-plated
Power feed through	max. 4 A
Installation position	variable
Protection class	IP65, IP66, IP67 (conforms to EN 60529) when screwed together
Dimensions (H x W x D)	approx. 126 x 30 x 26.5 mm (without connectors)

## 4.1.2 Fixing

### NOTICE

#### Dirt during assembly

Dirty connectors can lead to malfunctions. Protection class IP67 can only be guaranteed if all cables and connectors are connected.

- Protect the plug connectors against dirt during the assembly.

Mount the module with two M3 screws on the mounting holes in the corners of the module. The mounting holes have no thread.

## 4.1.3 Tightening torques for plug connectors

Screw connectors tight with a torque wrench. (e.g. ZB8801 from Beckhoff)

Connector diameter	Tightening torque
M8	0.4 Nm
M12	0.6 Nm

## 4.2 Connection

### 4.2.1 Supply voltages

#### ⚠ WARNING

##### Power supply from SELV/PELV power supply unit!

SELV/PELV circuits (Safety Extra Low Voltage, Protective Extra Low Voltage) according to IEC 61010-2-201 must be used to supply this device.

Notes:

- SELV/PELV circuits may give rise to further requirements from standards such as IEC 60204-1 et al, for example with regard to cable spacing and insulation.
- A SELV (Safety Extra Low Voltage) supply provides safe electrical isolation and limitation of the voltage without a connection to the protective conductor, a PELV (Protective Extra Low Voltage) supply also requires a safe connection to the protective conductor.

The EtherCAT Box has one input for two supply voltages:

- **Control voltage  $U_s$**   
The following sub-functions are supplied from the control voltage  $U_s$ :
  - the fieldbus
  - the processor logic
  - typically the inputs and the sensors if the EtherCAT Box has inputs.
- **Peripheral voltage  $U_p$**   
For EtherCAT Box modules with digital outputs the digital outputs are typically supplied from the peripheral voltage  $U_p$ .  $U_p$  can be supplied separately. If  $U_p$  is switched off, the fieldbus function, the function of the inputs and the supply of the sensors are maintained.

The exact assignment of  $U_s$  and  $U_p$  can be found in the pin assignment of the I/O connections.

#### Redirection of the supply voltages

The power IN and OUT connections are bridged in the module. Hence, the supply voltages  $U_s$  and  $U_p$  can be passed from EtherCAT Box to EtherCAT Box in a simple manner.

#### NOTICE

##### Note the maximum current!

Ensure that the permitted current for the connectors is not exceeded when routing the supply voltages  $U_s$  and  $U_p$ :

M8 connector: max. 4 A  
7/8" connector: max 16 A

#### NOTICE

##### Unintentional cancellation of the electrical isolation possible

In some types of EtherCAT Box modules the ground potentials  $GND_s$  and  $GND_p$  are connected.

- If several EtherCAT Box modules are supplied with the same electrically isolated voltages, check whether there is an EtherCAT Box among them in which the ground potentials are connected.

### 4.2.1.1 Connectors

**NOTICE**

**Risk of confusion: supply voltages and EtherCAT**

Defect possible through incorrect insertion.

- Observe the color coding of the connectors:  
 black: Supply voltages  
 green: EtherCAT

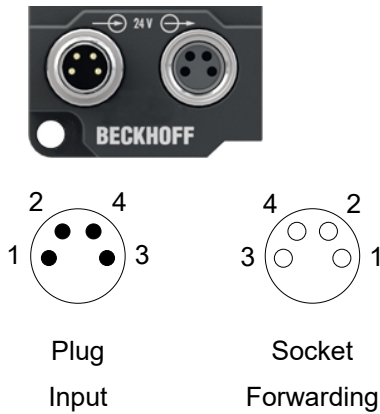

Fig. 4: M8 connector

Contact	Function	Description	Core color <sup>1)</sup>
1	U <sub>S</sub>	Control voltage	Brown
2	U <sub>P</sub>	Peripheral voltage	White
3	GND <sub>S</sub>	GND to U <sub>S</sub>	Blue
4	GND <sub>P</sub>	GND to U <sub>P</sub>	Black

<sup>1)</sup> The core colors apply to cables of the type: Beckhoff ZK2020-3xxx-xxxx

### 4.2.1.2 Status LEDs



LED	Display	Meaning
U <sub>S</sub> (control voltage)	off	The supply voltage U <sub>S</sub> is not available.
	green illuminated	The supply voltage U <sub>S</sub> is available.
U <sub>P</sub> (peripheral voltage)	off	The supply voltage U <sub>P</sub> is not available.
	green illuminated	The supply voltage U <sub>P</sub> is available.

### 4.2.1.3 Conductor losses

Take into account the voltage drop on the supply line when planning a system. Avoid the voltage drop being so high that the supply voltage at the box lies below the minimum nominal voltage. Variations in the voltage of the power supply unit must also be taken into account.



**Voltage drop on the supply line**

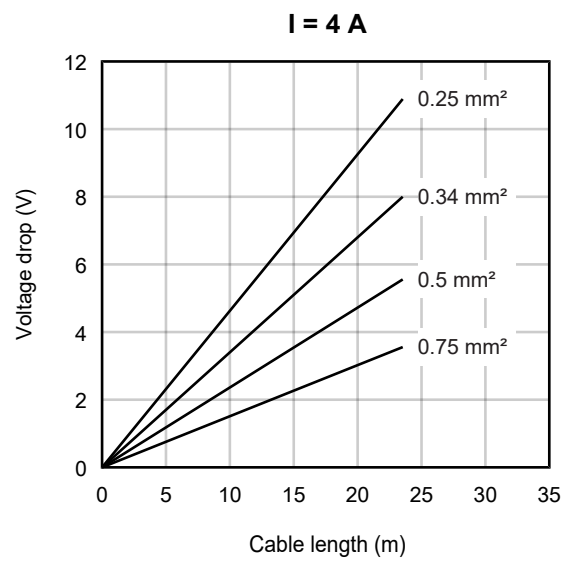
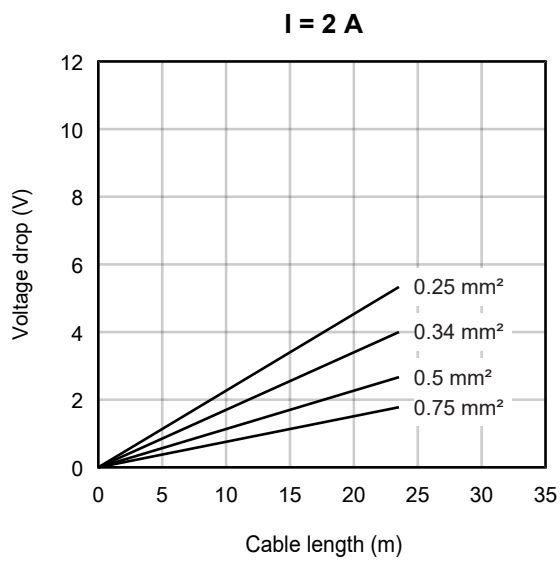

## 4.2.2 EtherCAT

### 4.2.2.1 Connectors

**NOTICE**

**Risk of confusion: supply voltages and EtherCAT**

Defect possible through incorrect insertion.

- Observe the color coding of the connectors:  
 black: Supply voltages  
 green: EtherCAT

EtherCAT Box Modules have two green M8 sockets for the incoming and downstream EtherCAT connections.



**Connection**

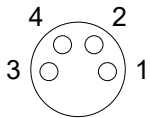

Fig. 5: M8 socket

EtherCAT	M8 socket	Core colors		
Signal	Contact	ZB9010, ZB9020, ZB9030, ZB9032, ZK1090-6292, ZK1090-3xxx-xxxx	ZB9031 and old versions of ZB9030, ZB9032, ZK1090-3xxx-xxxx	TIA-568B
Tx +	1	yellow <sup>1)</sup>	orange/white	white/orange
Tx -	4	orange <sup>1)</sup>	orange	orange
Rx +	2	white <sup>1)</sup>	blue/white	white/green
Rx -	3	blue <sup>1)</sup>	blue	green
Shield	Housing	Shield	Shield	Shield

<sup>1)</sup> Core colors according to EN 61918

**● Adaptation of core colors for cables ZB9030, ZB9032 and ZK1090-3xxxx-xxxx**

**i** For standardization, the core colors of the ZB9030, ZB9032 and ZK1090-3xxx-xxxx cables have been changed to the EN61918 core colors: yellow, orange, white, blue. So there are different color codes in circulation. The electrical properties of the cables have been retained when the core colors were changed.

### 4.2.2.2 Status LEDs



#### L/A (Link/Act)

A green LED labelled "L/A" is located next to each EtherCAT socket. The LED indicates the communication state of the respective socket:

LED	Meaning
off	no connection to the connected EtherCAT device
lit	LINK: connection to the connected EtherCAT device
flashes	ACT: communication with the connected EtherCAT device

#### Run

Each EtherCAT slave has a green LED labelled "Run". The LED signals the status of the slave in the EtherCAT network:

LED	Meaning
off	Slave is in "Init" state
flashes uniformly	Slave is in "Pre-Operational" state
flashes sporadically	Slave is in "Safe-Operational" state
lit	Slave is in "Operational" state

Description of the EtherCAT slave states

### 4.2.2.3 Cables

For connecting EtherCAT devices only shielded Ethernet cables that meet the requirements of at least category 5 (CAT5) according to EN 50173 or ISO/IEC 11801 should be used.

EtherCAT uses four wires for signal transmission.

Thanks to automatic line detection ("Auto MDI-X"), both symmetrical (1:1) or cross-over cables can be used between Beckhoff EtherCAT.

Detailed recommendations for the cabling of EtherCAT devices

## 4.2.3 Stepper motor, brake, encoder

### 4.2.3.1 Signal connection

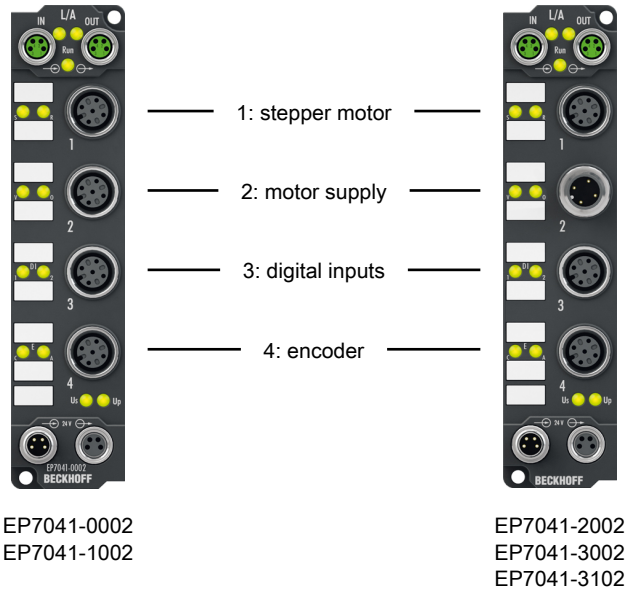

### NOTICE

#### Note the numbering of the M12 sockets

Mixing up the M12 connectors can damage the module.

#### M12 socket no. 1: stepper motor connection

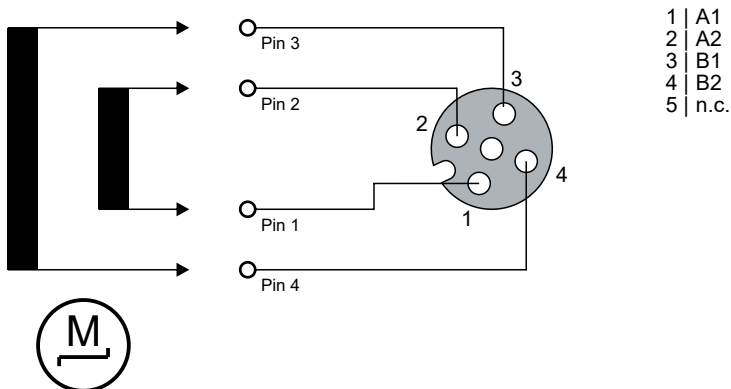

M12 socket no. 2: connection for motor supply

**NOTICE**

**The motor supply is not protected against polarity reversal**

Defect possible through polarity reversal.

- Ensure that the polarity is correct.

M12 socket, 5-pin

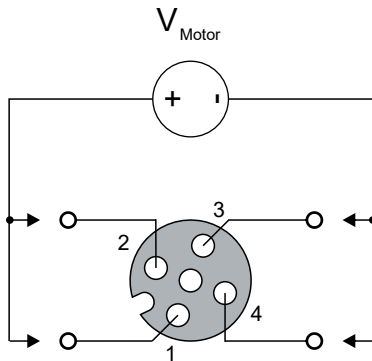

1,2 | V Motor  
3,4 | GND Motor  
5 | n.c.

M12 connector, 4-pin

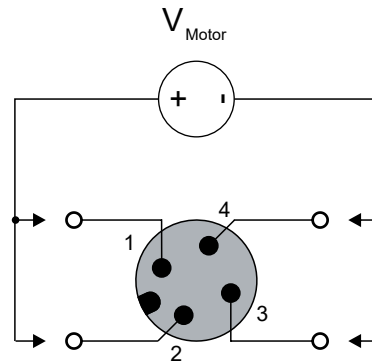

1,2 | V Motor  
3,4 | GND Motor

M12 socket no. 3: connection for digital inputs and outputs

**NOTICE**

**Incorrect signal levels due to electromagnetic interference**

The digital inputs are optimized for fast signal transmission and are therefore susceptible to electromagnetic interference.

Under the influence of electromagnetic interference, a false signal level can be detected.

- If necessary, use shielded signal lines.

The signal connection of the digital inputs and outputs is done via M12 connectors.

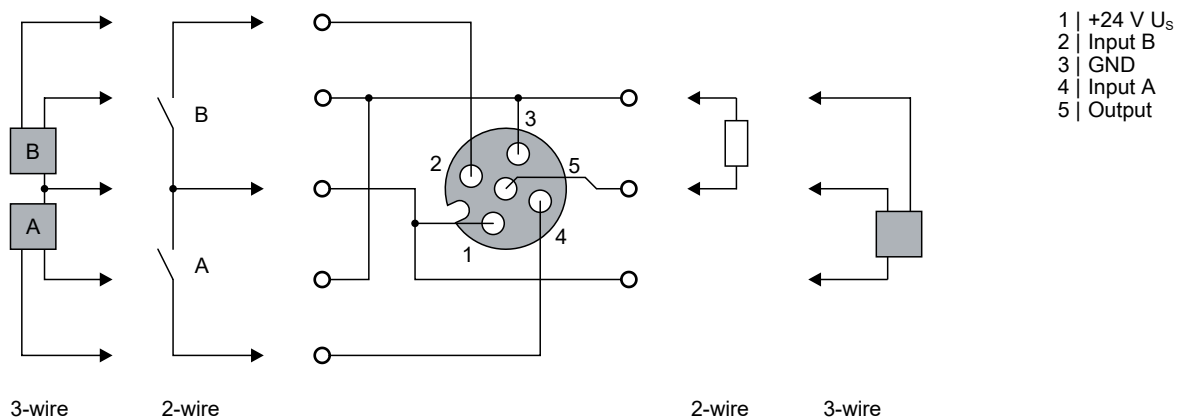

The sensors are supplied with a common maximum current of 0.5 A from the control voltage  $U_C$ .

The output is short-circuit proof and protected against polarity reversal.

LEDs indicate the signal state of the inputs and outputs.

**M12 socket no. 4: encoder connection****NOTICE****The encoder supply voltage is not short-circuit proof.**

Risk of damage due to short circuit.

- Avoid short-circuiting the encoder supply voltage "V Enc".

**NOTICE****Incorrect signal levels due to electromagnetic interference**

The encoder inputs are optimized for fast signal transmission and are therefore susceptible to electromagnetic interference.

Under the influence of electromagnetic interference, a false signal level can be detected.

- If necessary, use shielded signal lines.

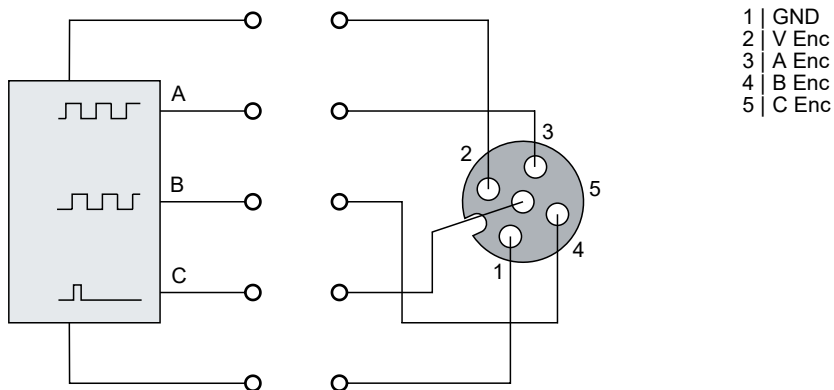

4.2.3.2 Status LEDs

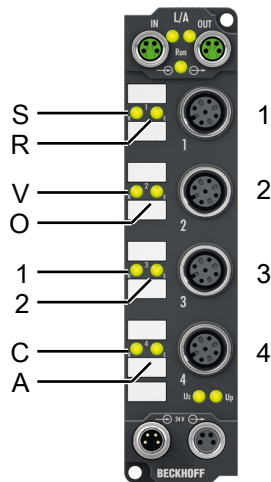

Connection	LED	Display	Meaning
Connection 1: stepper motor	S	green	The output stage is enabled.
		yellow	If motor disabled: Motor control in standby If motor enabled: Warning, configuration error. Check the motor status.
		red	Error. Check the Diag Messages
	R	green	Motor is running
		red	Internal error
Connection 2: motor supply input	V	off	The motor supply is not available.
		green	The motor supply is available.
	O	off	The digital output gives a low level.
		green	The digital output gives a high level.
Connection 3: digital inputs digital output	1	off	Low level at digital input 1.
		green	High level at digital input 1.
	2	off	Low level at digital input 2.
		green	High level at digital input 2.
Connection 4: encoder	C	flashes	Encoder track C
	A	flashes	Encoder track A

## 4.3 ATEX notes

### 4.3.1 ATEX - Special conditions

#### ⚠ WARNING

**Observe the special conditions for the intended use of EtherCAT Box modules in potentially explosive areas – directive 94/9/EU.**

- The certified components are to be installed with a BG2000-0000 or BG2000-0010 protection enclosure [▶ 33] that guarantees a protection against mechanical hazards!
- If the temperatures during rated operation are higher than 70°C at the feed-in points of cables, lines or pipes, or higher than 80°C at the wire branching points, then cables must be selected whose temperature data correspond to the actual measured temperature values!
- Observe the permissible ambient temperature range of 0 to 55°C for the use of EtherCAT Box modules in potentially explosive areas!
- Measures must be taken to protect against the rated operating voltage being exceeded by more than 40% due to short-term interference voltages!
- The connections of the certified components may only be connected or disconnected if the supply voltage has been switched off or if a non-explosive atmosphere is ensured!

#### Standards

The fundamental health and safety requirements are fulfilled by compliance with the following standards:

- EN 60079-0: 2006
- EN 60079-15: 2005

#### Marking

The EtherCAT Box modules certified for potentially explosive areas bear the following marking:



II 3 G Ex nA II T4 DEKRA 11ATEX0080 X Ta: 0 - 55°C

or



II 3 G Ex nA nC IIC T4 DEKRA 11ATEX0080 X Ta: 0 - 55°C

#### Batch number (D number)

The EtherCAT Box modules bear a batch number (D number) that is structured as follows:

D: WW YY FF HH

WW - week of production (calendar week)

YY - year of production

FF - firmware version

HH - hardware version

Example with batch number 29 10 02 01:

29 - week of production 29

10 - year of production 2010

02 - firmware version 02

01 - hardware version 01



### 4.3.2 BG2000 - EtherCAT Box protection enclosures

#### ⚠ WARNING

##### Risk of electric shock and damage of device!

Bring the EtherCAT system into a safe, powered down state before starting installation, disassembly or wiring of the modules!

#### ATEX

#### ⚠ WARNING

##### Mount a protection enclosure!

To fulfill the special conditions according to ATEX [▶ 32], a BG2000-0000 or BG2000-0010 protection enclosure has to be mounted over the EtherCAT Box.

#### Installation

Put the cables for EtherCAT, power supply and sensors/actuators through the hole of the protection enclosure.

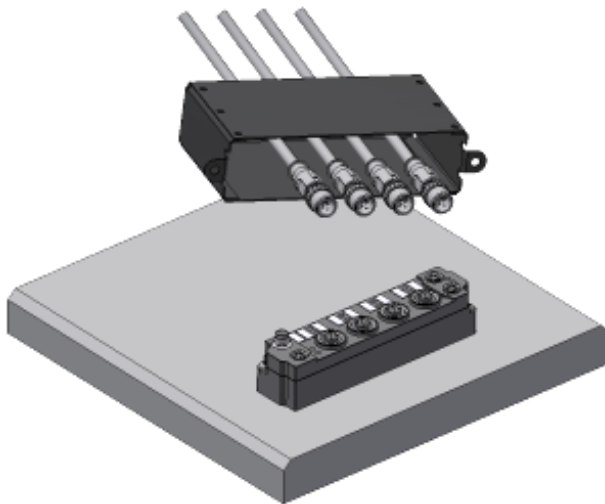

Fig. 6: BG2000 - putting the cables

Fix the wires for EtherCAT, power supply and sensors/actuators to the EtherCAT Box.

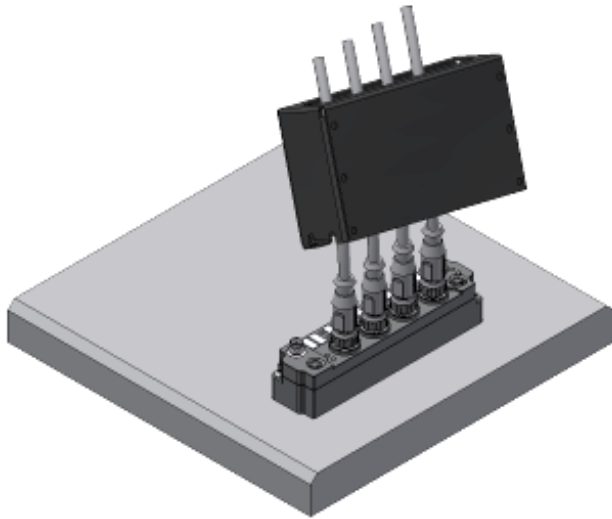

Fig. 7: BG2000 - fixing the cables

Mount the protection enclosure over the EtherCAT Box.

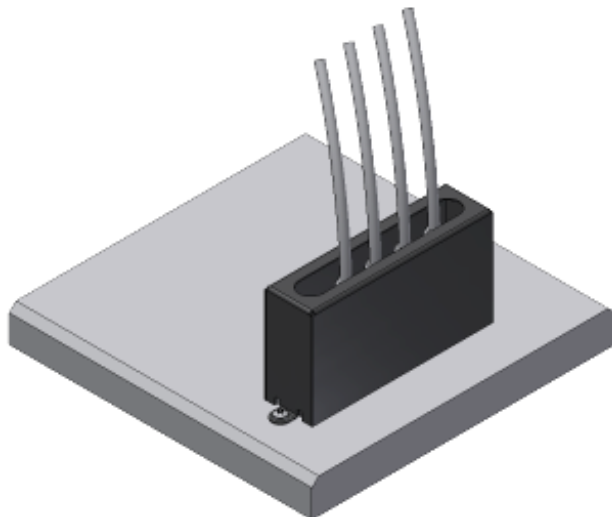

Fig. 8: BG2000 - mounting the protection enclosure

### 4.3.3 ATEX Documentation



#### **Notes about operation of EtherCAT Box Modules (EPxxxx-xxxx) in potentially explosive areas (ATEX)**

Pay also attention to the continuative documentation Notes about operation of EtherCAT Box Modules (EPxxxx-xxxx) in potentially explosive areas (ATEX) that is available in the download area of the Beckhoff homepage <http://www.beckhoff.com>!

## 4.4 Disposal



Products marked with a crossed-out wheeled bin shall not be discarded with the normal waste stream. The device is considered as waste electrical and electronic equipment. The national regulations for the disposal of waste electrical and electronic equipment must be observed.

## **5 Commissioning/Configuration**

### **5.1 Integrating into a TwinCAT project**

The procedure for integration in a TwinCAT project is described in this [Quick start guide](#).

## 5.2 Integration into the NC configuration

(Master: TwinCAT 2.11)

### **i** Installation of the latest XML device description

Please ensure that you have installed the corresponding latest XML device description in TwinCAT. This can be downloaded from the Beckhoff website <https://www.beckhoff.com>.

Integration into the NC can be accomplished as follows:

- The terminal must already have been inserted manually under I/O devices or have been scanned in by the system (see section "Inserting the terminal in the EtherCAT Terminal network").
- First add a new task. Right-click on NC configuration and select "Append Task..." (see Fig. *Adding a new task*).
- Rename the task if required and confirm with OK.

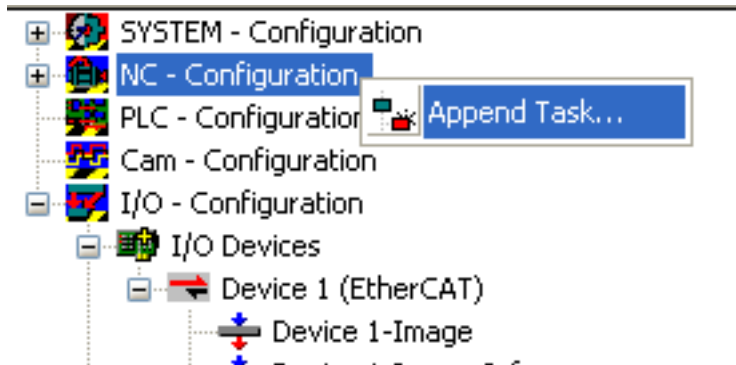

Fig. 9: Adding a new task

- Right-click on Axes, then add a new axis (see Fig. *Linking the axis with the terminal*).

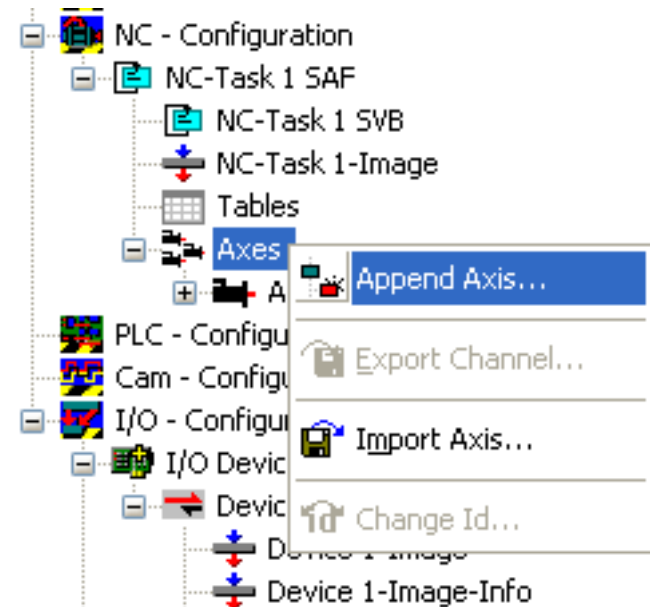

Fig. 10: Adding a new axis

- Select Continuous Axis type and confirm with OK (see Fig. 3).

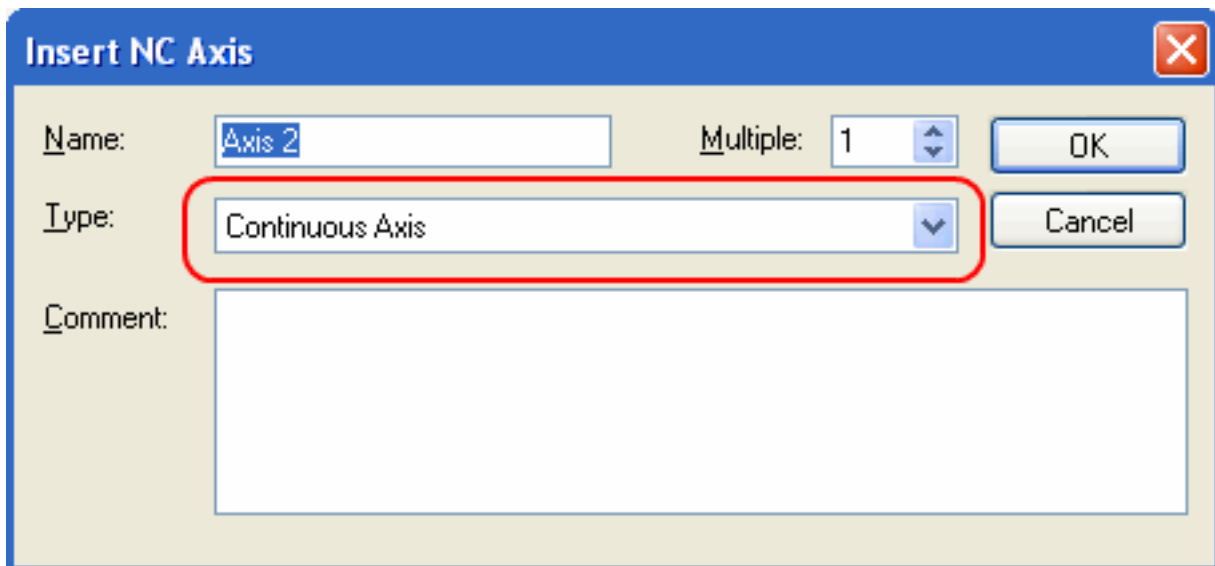

Fig. 11: Selecting and confirming the axis type

- Left-click your axis to select it. Under the *Settings* tab select "Link To..." (see Fig. *Linking the axis with the terminal*).

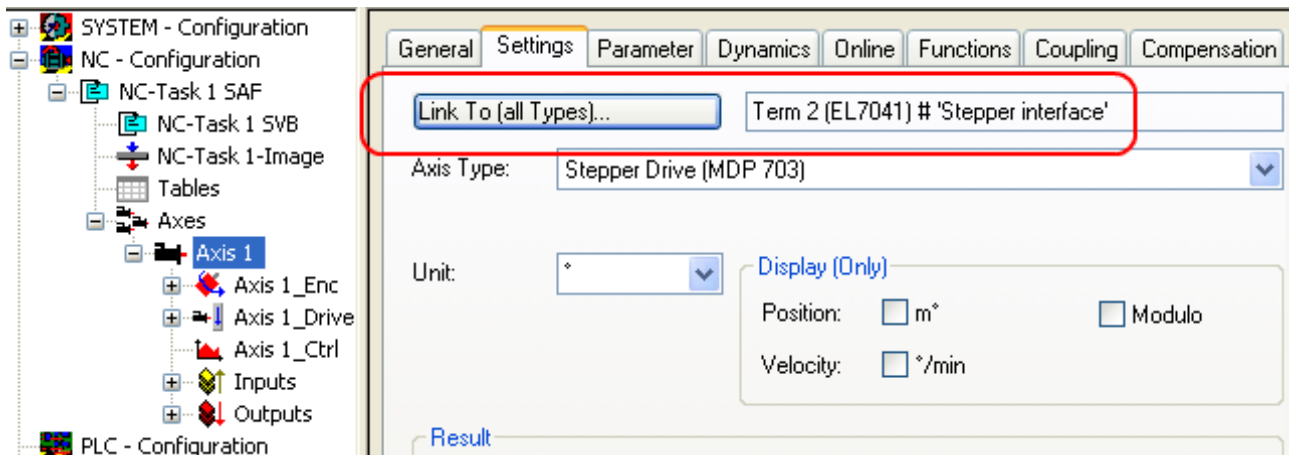

Fig. 12: Linking the axis with the terminal

- Select the right terminal (Stepper Drive (MDP 703)) and confirm with OK.

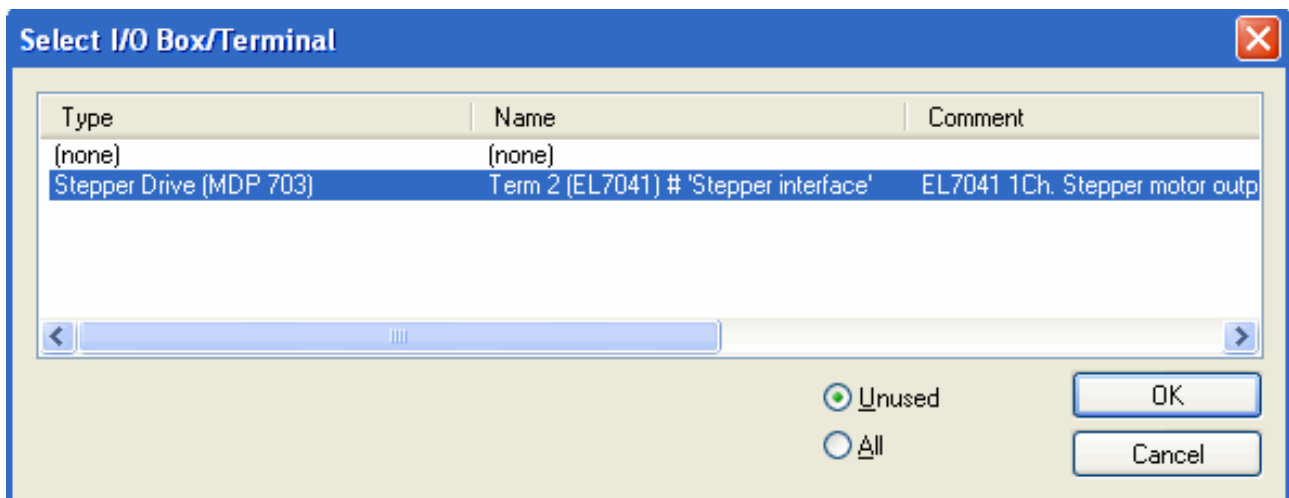

Fig. 13: Selecting the right terminal

- All main links between the NC configuration and the terminal are set automatically (see Fig. "Automatic linking of all main variables")

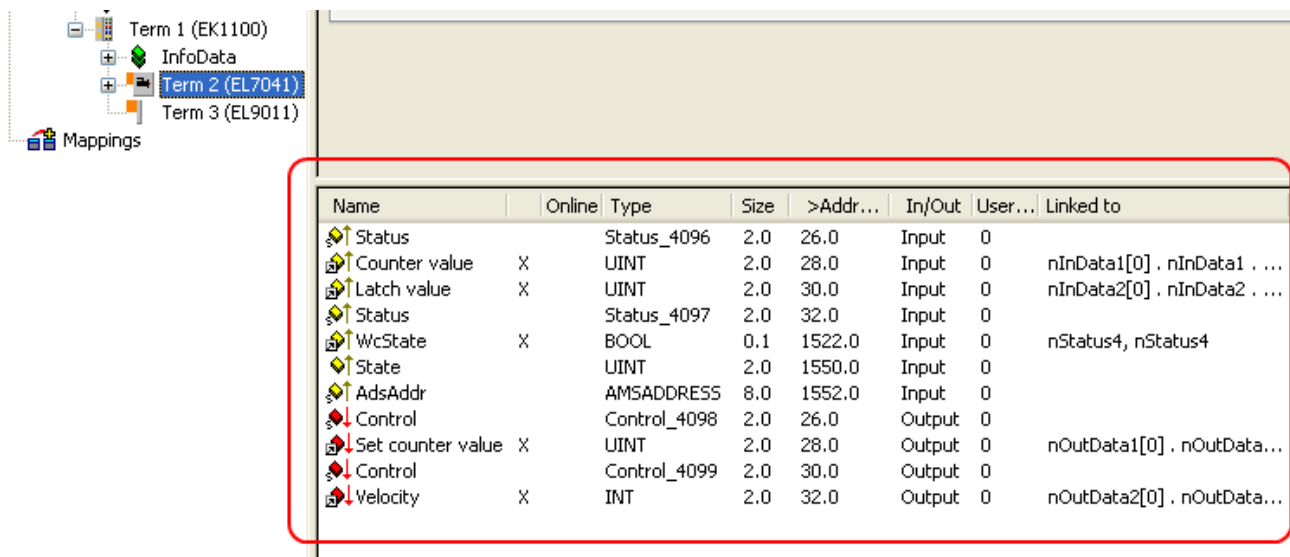

Fig. 14: Automatic linking of all main variables

- Several parameters have to be set before the motor can be started up. The values can be found in section "[Configuration of the main parameters |> 42](#)". Please set these parameters before continuing with the motor commissioning procedure.

**Commissioning the motor with the NC**

- Once the parameters are set, the motor is basically ready for operation. Individual further parameters have to be adapted to the respective application.
- To commission the axis, activate the configuration (Ctrl+Shift+F4), select the axis, select tab *Online* and enable the axis under *Set*.
- Set all check marks and set *Override* to 100 (see Fig. 7). The axis can then be moved.

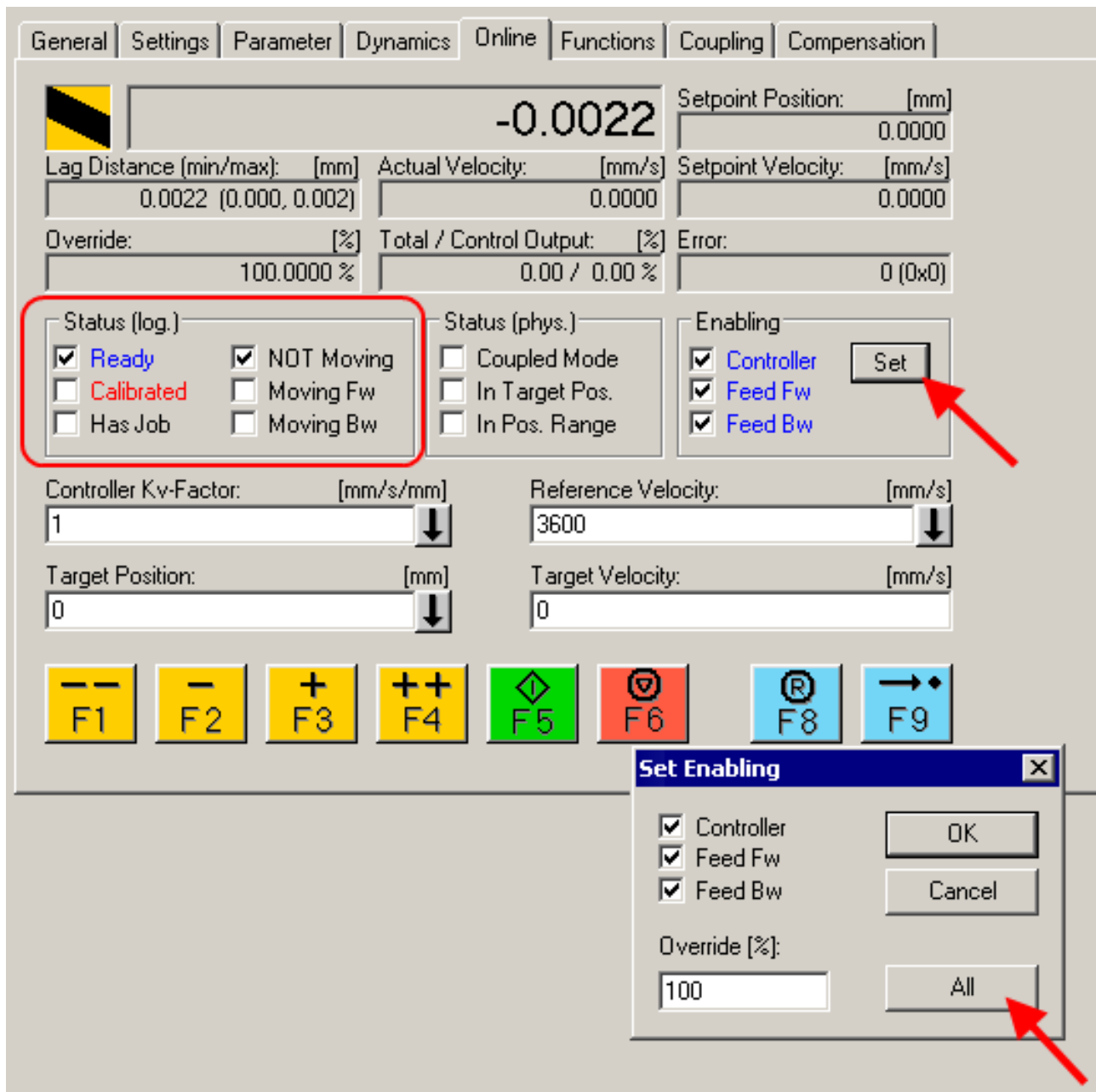

Fig. 15: Enabling an axis

You can now move the axis with the function keys F1, F2 (Backward) or F3, F4 (Forward).

Alternatively you can control the axis via the *Functions* tab.

### Example

- Select as *Reversing Sequence* as the start mode.
- Enter the required *Target Position1*, e.g. 5000°.
- Enter the required *Target Velocity*, e.g. 1200°/s.
- Enter the required *Target Position2*, e.g. 0°.
- Enter the required *Idle Time*, e.g. 1 s.
- Select *Start*.



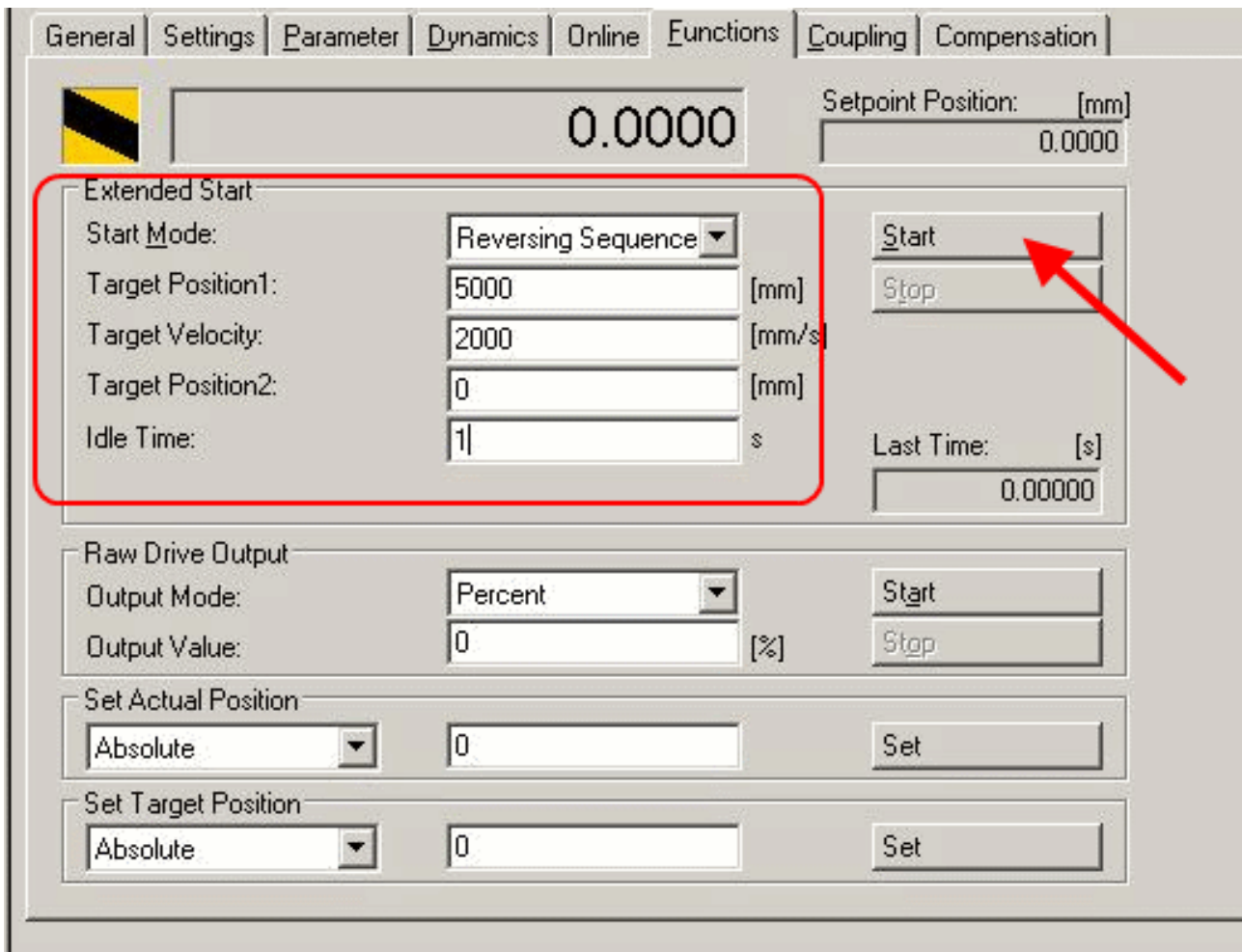

Fig. 16: Axis control, "Functions" tab

The motor now travels to Position 1, remains there for 1 s and then returns to Position 2. This is repeated until you click Stop.

## 5.3 Configuration of the main parameters

The data specified here apply to an AS 1050-0120 stepper motor and are intended as an example. For other motors the values may vary, depending on the application.

### Setting the CoE objects

**● Execution of changes**

**i** Changes to CoE objects are only executed after the module has been placed in the Init state. Changes are only active after that.

### Adaptation of current and voltage

**NOTICE**

**The motor may overheat!**

In order to prevent overheating of the connected motor it is important to adapt the current and voltage output from the stepper interface to the motor.

To do this, set the indices [0x8010:01 \[▶ 73\]](#) *Maximal current* and [0x8010:03 \[▶ 73\]](#) *Nominal voltage* in the CoE register to suitable values (see Fig. *Adaptation of current and voltage*).

*Reduced current* can be set in index [0x8010:02 \[▶ 73\]](#). This reduces the coil current when at a standstill (and therefore the power dissipation). Please note that the torque is also reduced.

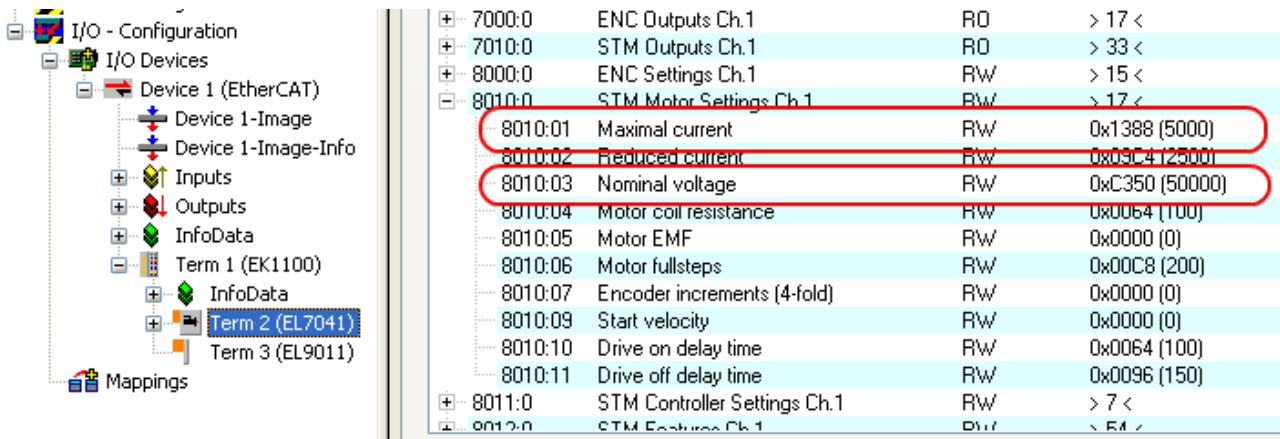

Fig. 17: Adaptation of current and voltage

### Base frequency selection

Microstepping is set to 1/64 and cannot be changed. However, the base frequency can be changed (default: 2000). To do this, mark the module and select the *CoE Online* tab. Change the base frequency by double-clicking on the index [0x8012:05 \[▶ 74\]](#) *Speed range* (Fig. *Setting the base frequency*).

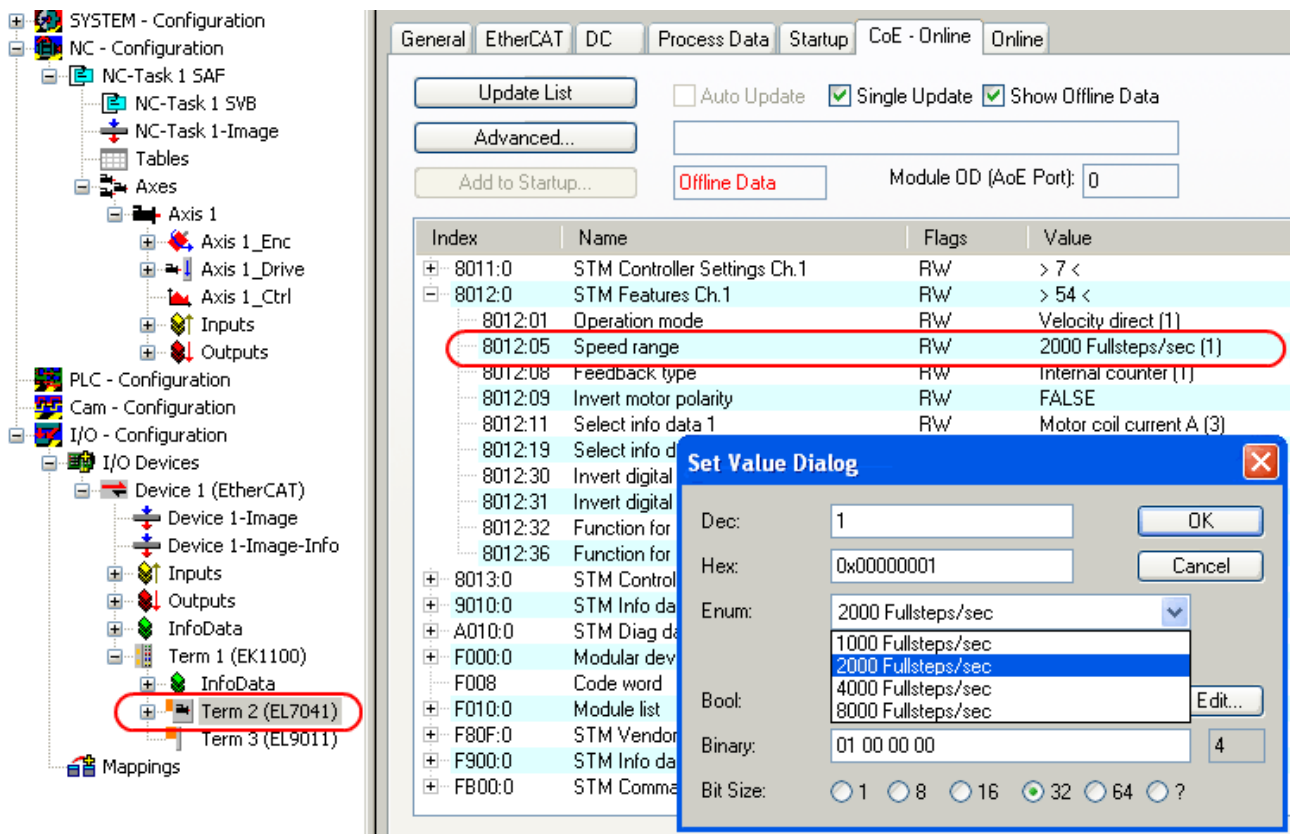

Fig. 18: Setting the base frequency

### Selecting the feedback system

The module with encoder connections provides a choice of two possibilities for the feedback system:

- Internal Counter (**default**): Use internal counter for position feedback
- Encoder: Use external encoder for position feedback

### ● Setting the feedback type

**i** By default, the stepper module is set to internal counter. If an external encoder is used, the setting must be changed by double-clicking on the index 0x8012:08 [▶ 74] Feedback type in the Enum menu (Fig. *Selecting the feedback system*).

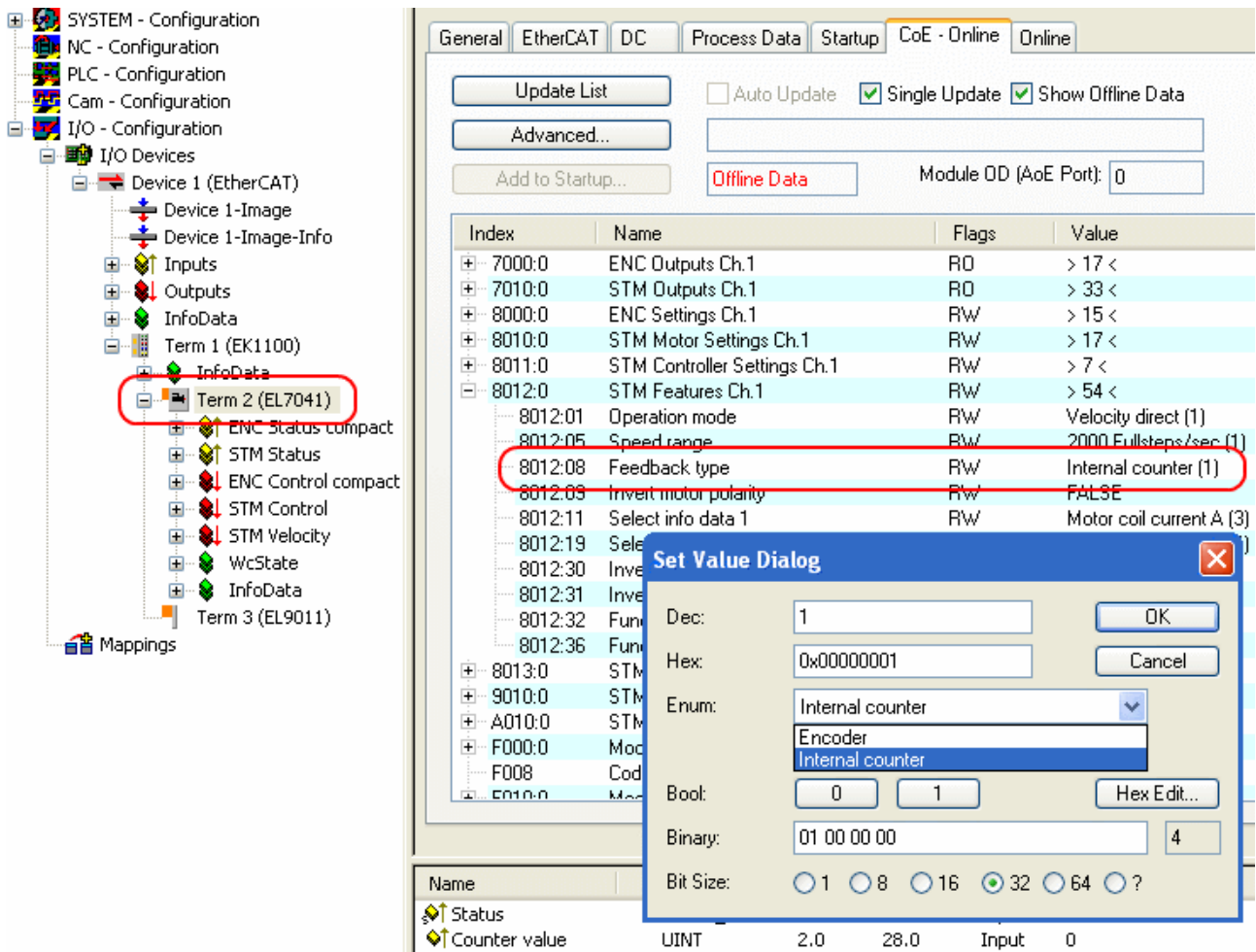

Fig. 19: Selecting the feedback system

**K<sub>A</sub> factor (EP7041-0002 [▶ 12] and EP7041-1002 [▶ 12]only)**

The K<sub>A</sub> factor can be used to adapt the current during the acceleration phases. The current increase is calculated as follows.

$$\text{Current increase in mA} = \text{speed difference} \times K_A / 1000$$

The steeper the speed ramp, the higher the current increase.

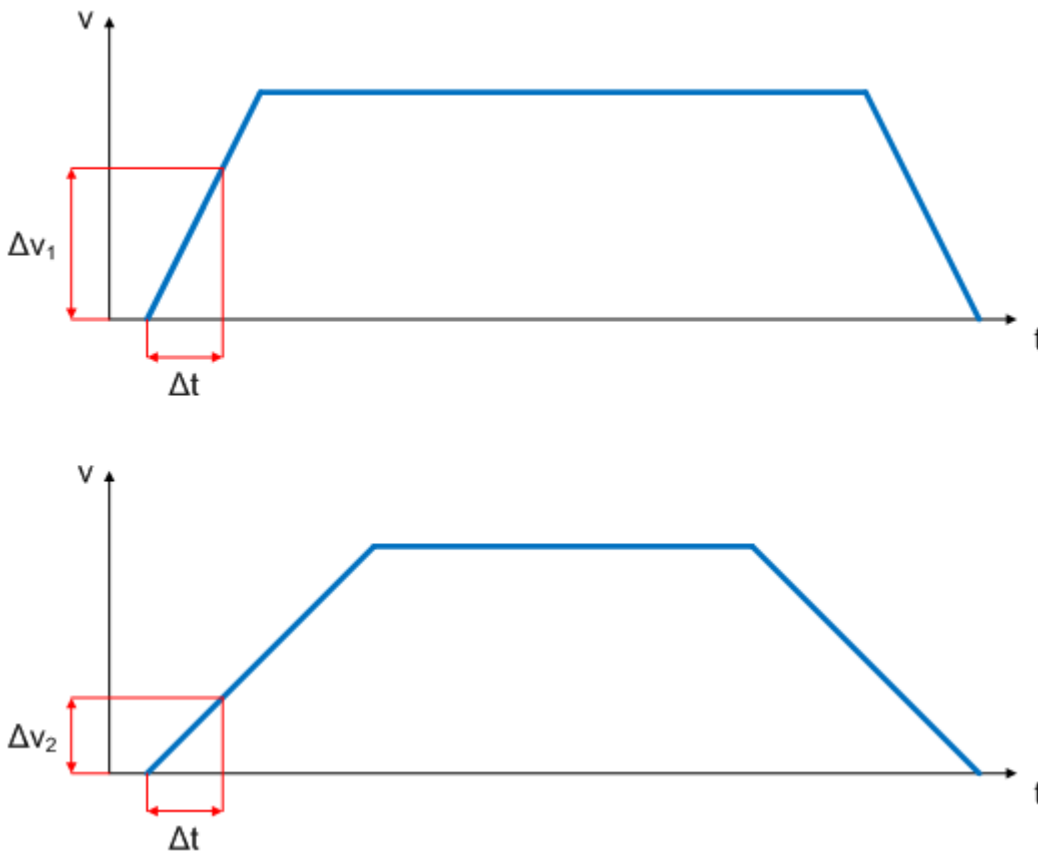

Fig. 20: Speed ramps

This value can be set in index [0x8011:07](#) [▶ 73] *K<sub>A</sub> factor (curr.)* (see fig. *Setting the K<sub>A</sub> factor*).

The screenshot shows a configuration interface. On the left is a tree view with 'Term 2 (EL7041)' selected. On the right is a table of parameters:

0000:0	ENC Settings Ch.1	RW	> 10 <
8010:0	STM Motor Settings Ch.1	RW	> 17 <
8011:0	STM Controller Settings Ch.1	RW	> 7 <
8011:01	Kp factor (curr.)	RW	0x00C8 (200)
8011:02	Ki factor (curr.)	RW	0x0002 (2)
8011:03	Inner window (curr.)	RW	0x00 (0)
8011:05	Outer window (curr.)	RW	0x00 (0)
8011:06	Filter cut off frequency (curr.)	RW	0x0000 (0)
8011:07	K <sub>A</sub> factor (curr.)	RW	0x0000 (0)
8012:0	STM Features Ch.1	RW	> 54 <
8013:0	STM Controller Settings 2 Ch.1	RW	> 6 <
9010:0	STM Info data Ch.1	RO	> 8 <
A010:0	STM Diag data Ch.1	RO	> 17 <

Fig. 21: Setting the K<sub>A</sub> factor

**NC settings**

**Reference speed selection**

The maximum speed can be calculated from the base frequency and the motor frequency.

**v**  
 $v_{max} = \text{base frequency} / \text{motor frequency} = (2000 \text{ full steps} / \text{s}) / (200 \text{ full steps} / \text{rev}) = 10 \text{ revolutions} / \text{s}$

The reference speed can be calculated by multiplying the maximum speed with the distance per revolution.

$v_{ref} = 10 \text{ revolutions} / \text{s} \times 360^\circ = 3600^\circ / \text{s}$

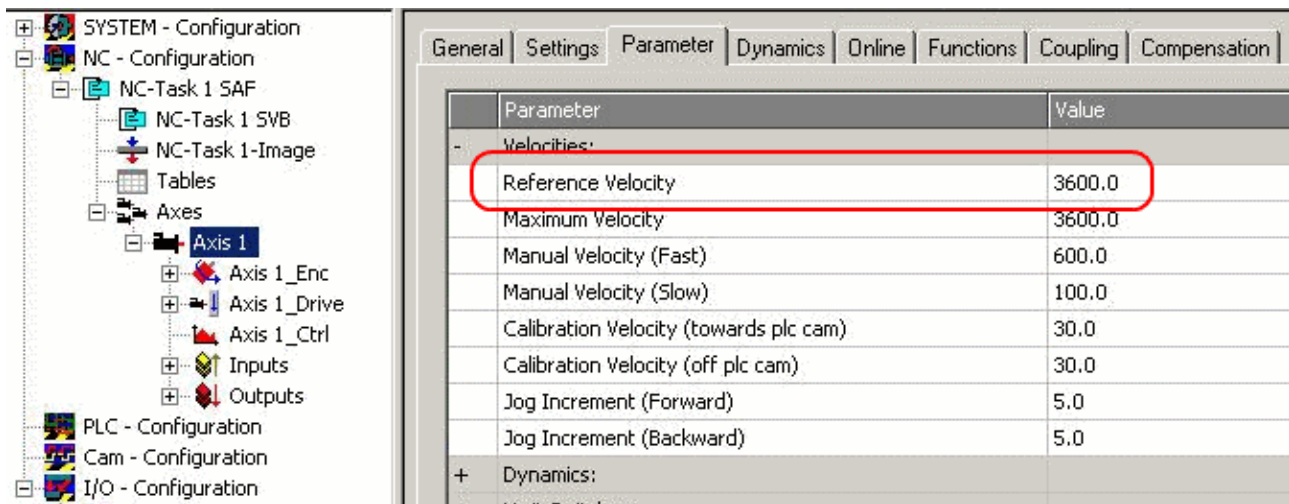

Fig. 22: Reference speed parameter

### Dead time compensation

The *dead time compensation* should theoretically be 3 cycles of the NC cycle time, although in practice 4 cycles are preferable. At a cycle time of 2 ms it should therefore be 0.008 s. The *dead time compensation* can be found under *Advanced Settings* in the encoder parameters.

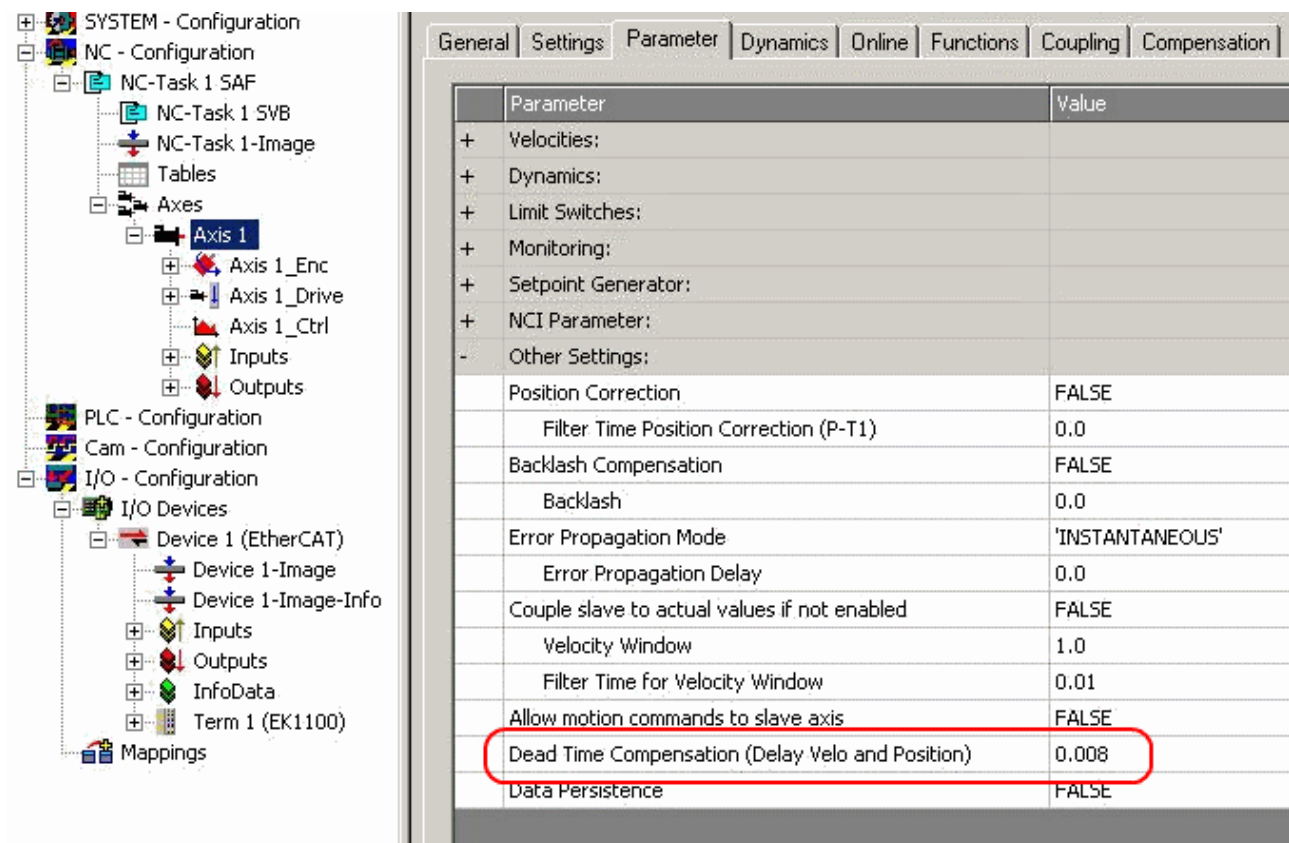

Fig. 23: Dead time compensation parameter

### Scaling factor

The scaling factor can be changed by selecting *NC Axis 1\_Enc* and the *Parameter* tab in the NC (see fig. *Setting the scaling factor (example with encoder)*). The value can be calculated with the formulas specified below.

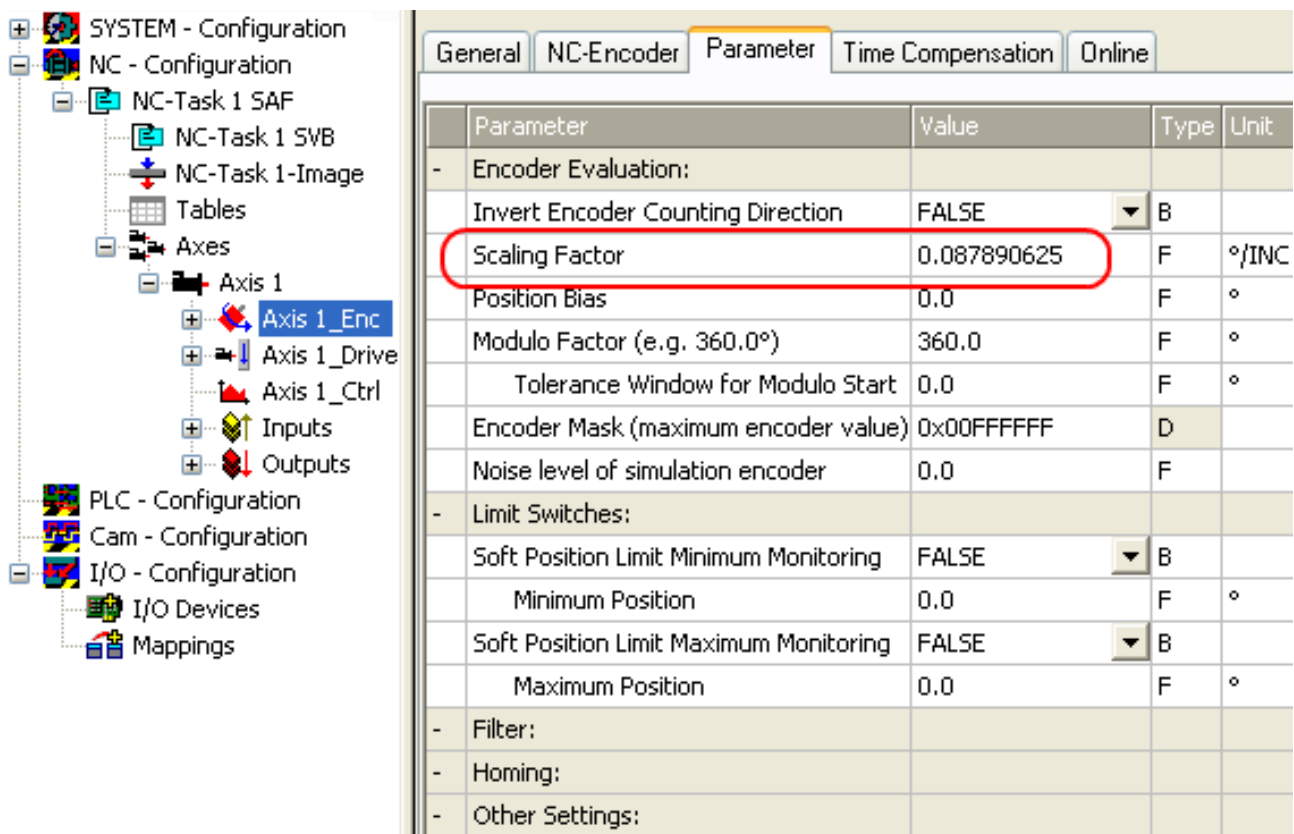

Fig. 24: Setting the scaling factor (example with encoder)

**Calculation of the scaling factor**

with encoder:

$$SF = \text{distance per revolution} / \text{increments} \times 4 = 360^\circ / 1024 \times 4 = 0.087890625 \text{ mm} / \text{INC}$$

without encoder:

$$SF = \text{distance per revolution} / \text{full steps} \times \text{microsteps} = 360^\circ / 200 \times 64 = 0.028125 \text{ mm} / \text{INC}$$

**Position lag monitoring**

The position lag monitoring function checks whether the current position lag of an axis has exceeded the limit value. The position lag is the difference between the set value (control value) and the actual value reported back. If the terminal parameters are set inadequately, the position lag monitoring function may report an error when the axis is moved. During commissioning it may therefore be advisable to increase the limits of the *Position lag monitoring* slightly.

**NOTICE**

**ATTENTION: Damage to equipment, machines and peripheral components possible!**

Setting the position lag monitoring parameters too high may result in damage to equipment, machines and peripheral components.



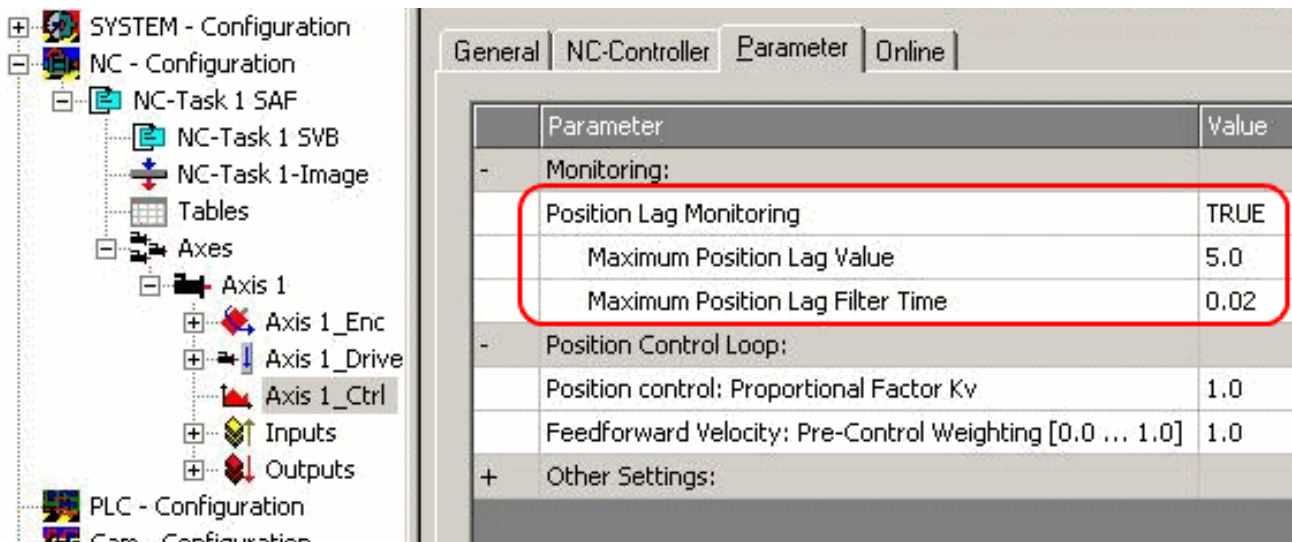

Fig. 25: Position lag monitoring parameters

**$K_v$  factors (only with external encoder)**

In the NC two proportional factors  $K_v$  can be set under *Axis 1\_Ctrl* on the *Parameter* tab. First select the position controller Type *with two P constants (with KA)* under the *NC Controller* tab. The two P constants are for the *Standstill* range and for the *Moving* range (see Fig. *Setting the proportional factor  $K_v$* ). The factors can be used to set the start-up torque and the braking torque to a different value than the drive torque. The threshold value can be set directly below (Position control: Velocity threshold  $V_{dyn}$ ) between 0.0 (0%) and 1.0 (100%). Fig. *Velocity ramp with  $K_v$  factor limit values* shows a speed ramp with thresholds of 30%. The  $K_v$  factor for Standstill ( $t_1$  and  $t_3$ ) can be different than the  $K_v$  factor for Moving ( $t_2$ ). In this case the same factor was used, since for stepper motors this function is less crucial than for DC motors.

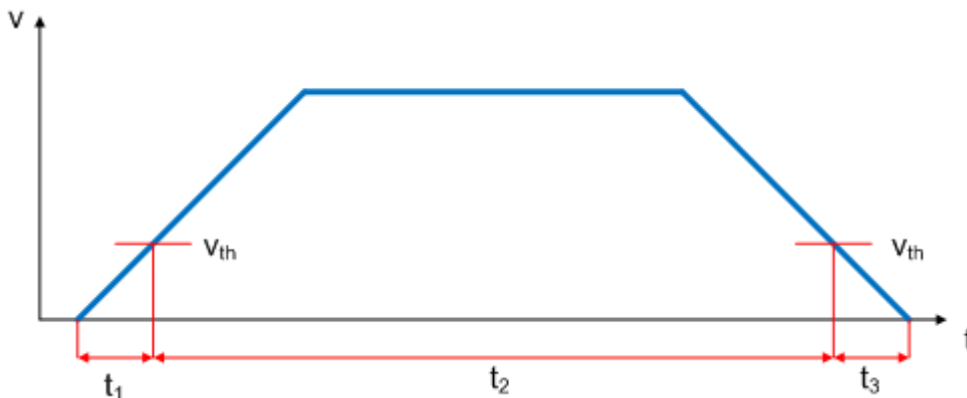

Fig. 26: Speed ramp with  $K_v$  factor limit values



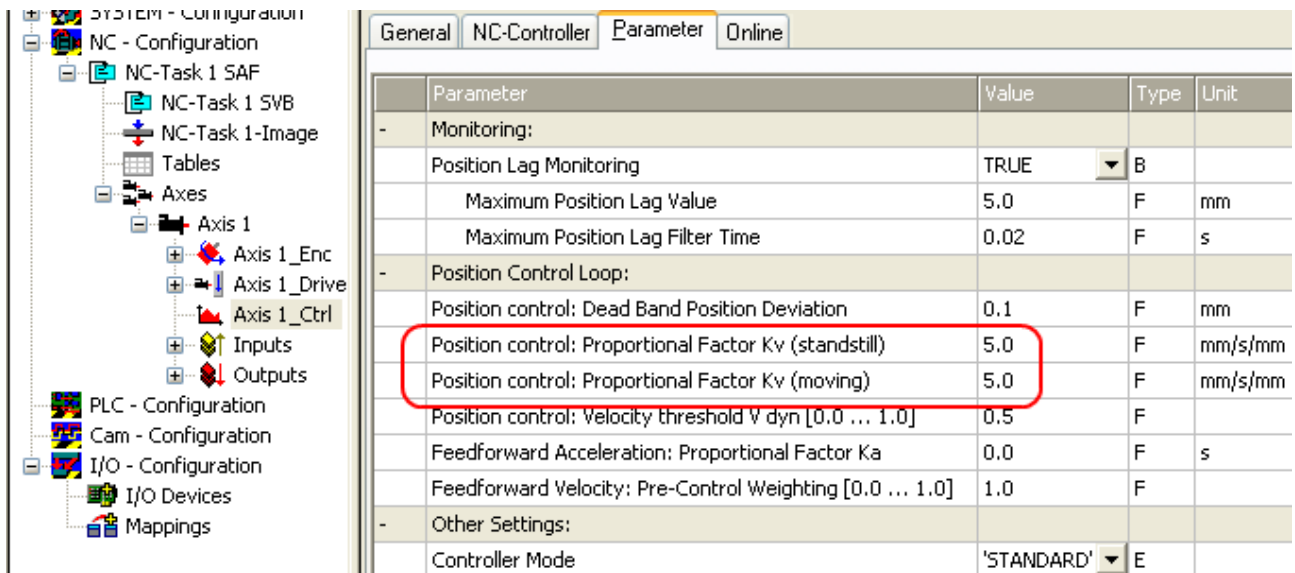

Fig. 27: Setting the proportional factor  $K_v$

**Dead band for position errors**

Microstepping can be used to target  $200 \times 64 = 12800$  positions. Since the encoder can only scan  $1024 \times 4 = 4096$  positions, positions between two encoder scan points may not be picked up correctly, in which case the terminal will control around this position. The dead band for position errors is a tolerance range within which the position is regarded as "reached" (Fig. *Dead band for position errors*).

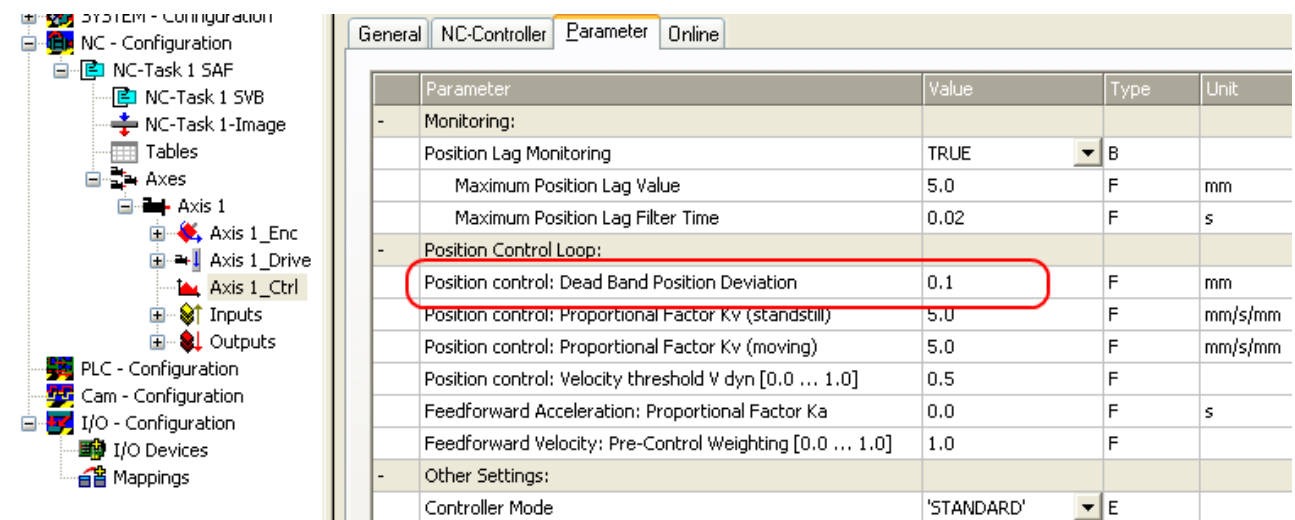

Fig. 28: Dead band for position errors

**Setting the acceleration time**

In order to pass through any resonances that may occur as quickly as possible, the ramps for the acceleration time and the deceleration time should be as steep as possible.

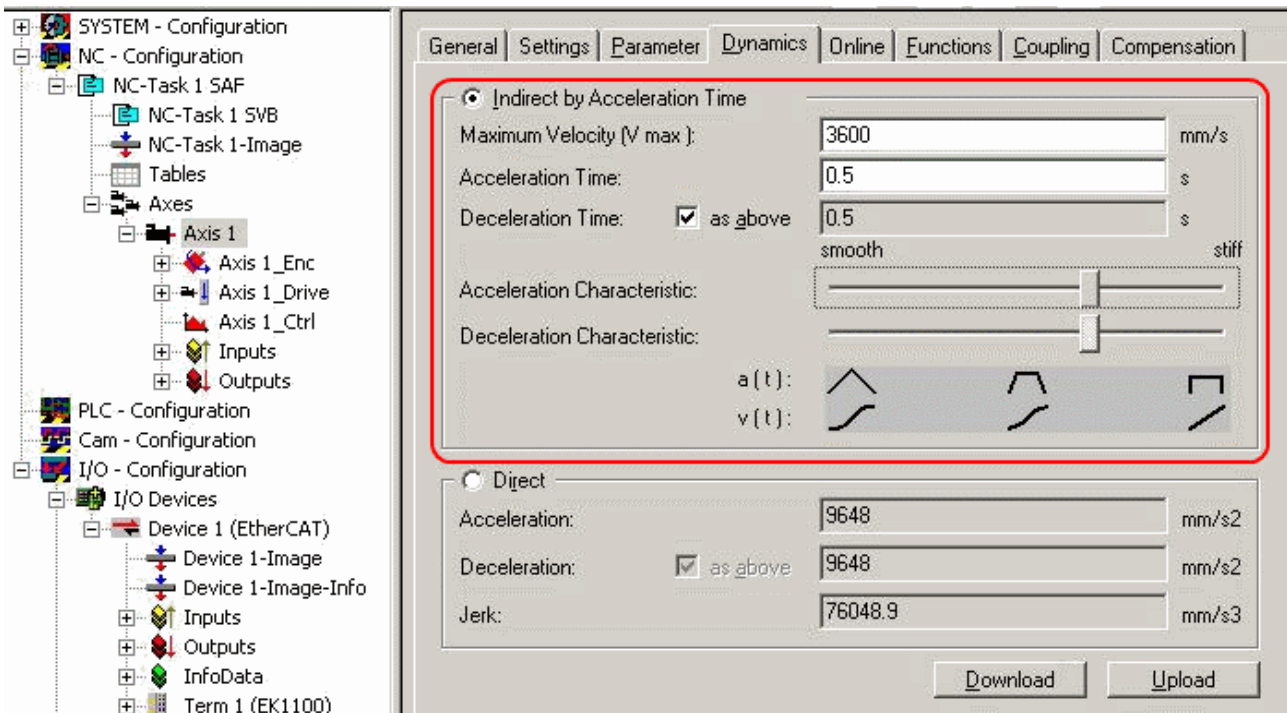

Fig. 29: Setting the acceleration time

## 5.4 Basic principles for the Positioning Interface

The *Positioning interface* offers the user a possibility to implement travel commands directly on the terminal.

### 5.4.1 Predefined PDO Assignment

The "Predefined PDO Assignment" enables a simplified selection of the process data. Select the function "Positioning interface" or "Positioning interface compact" in the lower part of the Process data tab. As a result, all necessary PDOs are automatically activated and the unnecessary PDOs are deactivated.

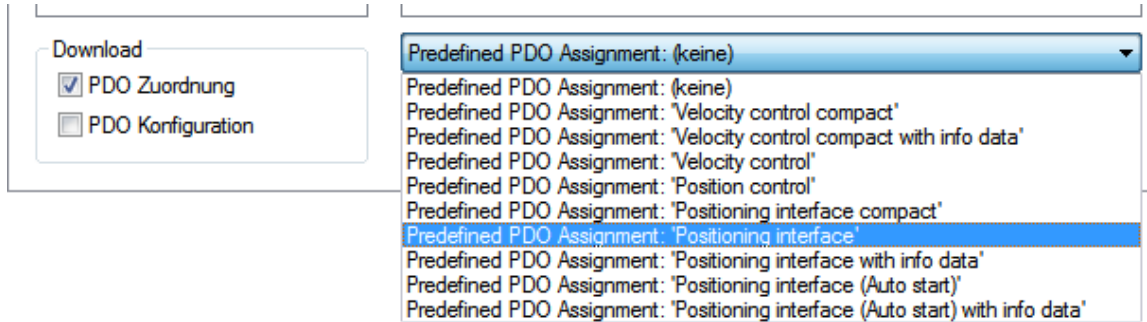

Fig. 30: Predefined PDO Assignment

### 5.4.2 Parameter set

Two objects are at the user's disposal in the CoE for the configuration – the "POS Settings" (Index 0x8020 [▶ 76]) and the "POS Features" (Index 0x8021 [▶ 77]).

Index	Name	Flags	Wert
8020:0	POS Settings Ch.1	RW	> 16 <
8020:01	Velocity min.	RW	100
8020:02	Velocity max.	RW	10000
8020:03	Acceleration pos.	RW	0x03E8 (1000)
8020:04	Acceleration neg.	RW	0x03E8 (1000)
8020:05	Deceleration pos.	RW	0x03E8 (1000)
8020:06	Deceleration neg.	RW	0x03E8 (1000)
8020:07	Emergency deceleration	RW	0x0064 (100)
8020:08	Calibration position	RW	0x00000000 (0)
8020:09	Calibration velocity (towards plc cam)	RW	200
8020:0A	Calibration Velocity (off plc cam)	RW	50
8020:0B	Target window	RW	0x000A (10)
8020:0C	In-Target timeout	RW	0x03E8 (1000)
8020:0D	Dead time compensation	RW	50
8020:0E	Modulo factor	RW	0x00000000 (0)
8020:0F	Modulo tolerance window	RW	0x00000000 (0)
8020:10	Position lag max.	RW	0x0000 (0)
8021:0	POS Features Ch.1	RW	> 22 <
8021:01	Start type	RW	Absolute (1)
8021:11	Time information	RW	Elapsed time (0)
8021:13	Invert calibration cam search direction	RW	TRUE
8021:14	Invert sync impulse search direction	RW	FALSE
8021:15	Emergency stop on position lag error	RW	FALSE
8021:16	Enhanced diag history	RW	FALSE

Fig. 31: Settings objects in the CoE

**POS Settings: Velocity min.:**

For reasons of performance when ramping down to the target position, the terminal needs a safety margin of 0.5 %. That means that, depending on the maximum velocity reached and the configured deceleration, the time is calculated at which the deceleration ramp begins. In order to always reach the destination reliably, 0.5 % is subtracted from the position determined. If the deceleration ramp has ended and the destination has not yet been reached, the terminal drives at the velocity "Velocity min." to the destination. It must be configured in such a way that the motor is able to stop abruptly and without a step loss at this velocity.

**Velocity max.:**

The maximum velocity with which the motor drives during a travel command

---

**● "Speed range" (index 0x8012:05 [▶ 74]) [applies to EL70x1]**

**i** Velocity min./max. are standardized to the configured "Speed range" (Index 0x8012:05 [▶ 74]). This means that for a "Speed range" of 4000 full steps/second, for example, for a speed output of 100 % (i.e. 4000 full steps/second) 10,000 should be entered under "Velocity max.", and 5,000 for 50 % (i.e. 2000 full steps/second).

---

**Acceleration pos.:**

Acceleration time in the positive direction of rotation.

The five parameters for acceleration also refer to the set "Speed range" and are given in ms. With a setting of 1000, the terminal accelerates the motor from 0 to 100 % in 1000 ms. At a speed of 50 % the acceleration time is linearly reduced to half accordingly.

**Acceleration neg.:**

Acceleration time in the negative direction of rotation.

**Deceleration pos.:**

Deceleration time in the positive direction of rotation.

**Deceleration neg.:**

Deceleration time in the negative direction of rotation.

**Emergency deceleration:**

Emergency deceleration time (both directions of rotation). If "Emergency stop" is set in the appropriate PDO, the motor is stopped within this time.

**Calibration position:**

The current counter value is loaded with this value after calibration.

**Calibration velocity (towards plc cam):**

Velocity with which the motor travels towards the cam during calibration.

**Calibration velocity (off plc cam):**

Velocity with which the motor travels away from the cam during calibration.

**Target window:**

Target window of the travel distance control. "In-Target" is set if the motor comes to a stop within this target window.

**In-Target timeout:**

"In-Target" is not set if the motor is not within the target window after the expiry of the travel distance control after this set time. This condition can be recognized only by checking the falling edge of "Busy".

**Dead time compensation:**

Compensation of the internal propagation delays. This parameter does not have to be changed with standard applications.

**Modulo factor:**

The "Modulo factor" is referred to for the calculation of the target position and the direction of rotation in the modulo operating modes. It refers to the controlled system.

**Modulo tolerance window:**

Tolerance window for the determination of the start condition of the modulo operating modes.

**POS Features:****Start type:**

The "*Start type*" specifies the type of calculation used to determine the target position (see below).

**Time information:**

The meaning of the "*Actual drive time*" displayed is configured by this parameter. At present this value cannot be changed, since there are no further selection options. The elapsed time of the travel command is displayed.

**Invert calibration cam search direction:**

In relation to a positive direction of rotation, the direction of the search for the calibration cam is configured here (travel towards the cam).

**Invert sync impulse search direction:**

In relation to a positive direction of rotation, the direction of the search is configured here in accordance with the HW sync pulse (travel away from the cam).

### 5.4.3 Information and diagnostic data

Via the information and diagnostic data, the user can obtain a more exact statement about which error occurred during a travel command.

Index	Name	Flags	Wert
9020:0	POS Info data Ch.1	RO	> 4 <
9020:01	Status word	RO	0x0000 (0)
9020:03	State (drive controller)	RO	Init (0)
9020:04	Actual position lag	RO	0
A010:0	STM Diag data Ch.1	RO	> 17 <
A020:0	POS Diag data Ch.1	RO	> 6 <
A020:01	Command rejected	RO	FALSE
A020:02	Command aborted	RO	FALSE
A020:03	Target overrun	RO	FALSE
A020:04	Target timeout	RO	FALSE
A020:05	Position lag	RO	FALSE
A020:06	Emergency stop	RO	FALSE

Fig. 32: Diagnostic objects in the CoE

#### POS Info data:

##### Status word:

The "*Status word*" reflects the status bits used in *Index 0xA020* in a data word, in order to be able to process them more simply in the PLC. The positions of the bits correspond to the number of the subindex-1.

Bit 0: Command rejected

Bit 1: Command aborted

Bit 2: Target overrun

##### State (drive controller):

The current status of the internal state machine is displayed here (see below).

#### POS Diag data:

##### Command rejected:

A dynamic change of the target position is not accepted each time by the terminal, since this is then not possible. The new command is rejected in this case and indicated by the setting of this bit.

These 3 diagnostic bits are transmitted synchronously to the controller by setting "*Warning*" in the PDO.

##### Command aborted:

The current travel command was prematurely aborted due to an internal error or by an "Emergency stop".

##### Target overrun:

In the case of a dynamic change of the target position, the change may take place at a relatively late point in time. The consequence of this may be that a change in the direction of rotation is necessary and that the new target position may be overrun. "*Target overrun*" is set if this occurs.

### 5.4.4 States of the internal state machine

The state (drive controller) (*Index 0x9020:03*) provides information about the current state of the internal state machine. For diagnostic purposes this can be read out by the PLC for the propagation delay. The internal cycle works constantly with 250  $\mu$ s. A connected PLC cycle is very probably slower (e.g. 1 ms). For this reason it may be the case that some states are not visible at all in the PLC, since these will sometimes run through only one internal cycle.

Name	ID	Description
INIT	0x0000	Initialization/preparation for the next travel command.
IDLE	0x0001	Wait for the next travel command.
START	0x0010	The new command is evaluated and the corresponding calculations are performed.
ACCEL	0x0011	Acceleration phase.
CONST	0x0012	Constant phase
DECEL	0x0013	Deceleration phase
EMCY	0x0020	An " <i>Emergency stop</i> " has been triggered.
STOP	0x0021	The motor has stopped.
CALI_START	0x0100	Start of a calibration command.
CALI_GO_CAM	0x0110	The motor is being driven towards the cam.
CALI_ON_CAM	0x0111	The cam has been reached.
CALI_GO_SYNC	0x0120	The motor is being driven in the direction of the HW sync pulse.
CALI_LEAVE_CAM	0x0121	The motor is being driven away from the cam.
CALI_STOP	0x0130	End of the calibration phase.
CALIBRATED	0x0140	The motor is calibrated.
NOT_CALIBRATED	0x0141	The motor is not calibrated.
PRE_TARGET	0x1000	The set position has been reached; the position controller "pulls" the motor further into the target; " <i>In-Target timeout</i> " is started here.
TARGET	0x1001	The motor has reached the target window within the timeout.
TARGET_RESTART	0x1002	A dynamic change of the target position is processed here.
END	0x2000	End of the positioning phase.
WARNING	0x4000	A warning state occurred during the travel command; this is processed here.
ERROR	0x8000	An error state occurred during the travel command; this is processed here.
UNDEFINED	0xFFFF	Undefined state (can occur, for example, if the driver stage has no control voltage).



### 5.4.5 Standard sequence of a travel command

The “normally” sequence of a travel command is shown in the following flow diagram. Coarse distinction is made between these four stages:

**Startup**

Test the system and the ready status of the motor.

**Start positioning**

Write all variables and calculate the desired target position with the appropriate “Start type”. Subsequently, start the travel command.

**Evaluate status**

Monitor the terminal state and, if necessary, dynamically change the target position.

**Error handling**

In case of error, procure the necessary information from the CoE and evaluate it.

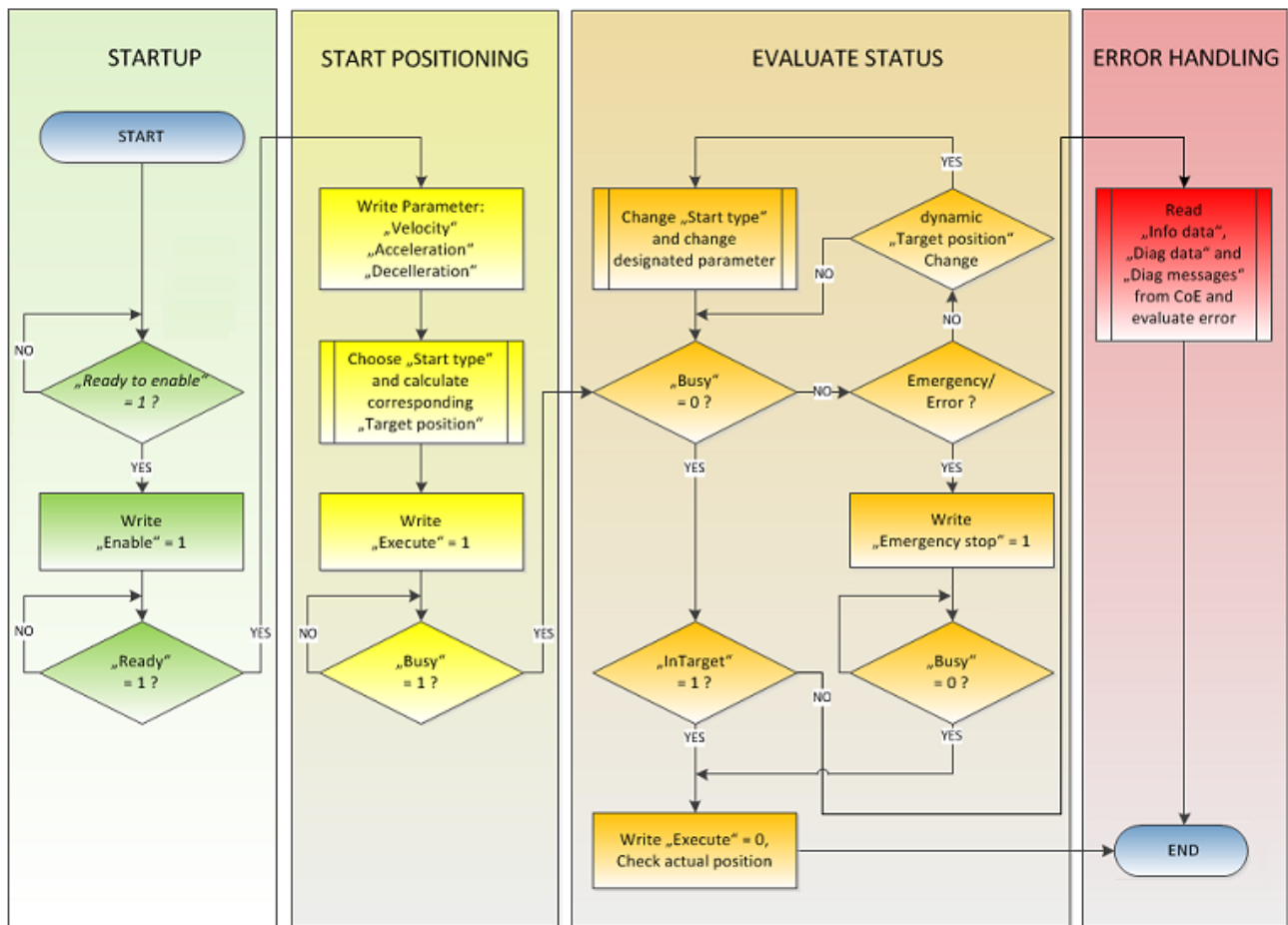

Fig. 33: Flow diagram for a travel command



### 5.4.6 Start types

The *Positioning interface* offers different types of positioning. The following table contains all commands supported; these are divided into four groups.

#### Supported “Start types” of the “Positioning interface”

Name	Command	Group	Description
ABSOLUTE	0x0001	Standard [ <a href="#">▶ 57</a> ]	Absolute positioning to a specified target position
RELATIVE	0x0002		Relative positioning to a calculated target position; a specified position difference is added to the current position
ENDLESS_PLUS	0x0003		Endless travel in the positive direction of rotation (direct specification of a speed)
ENDLESS_MINUS	0x0004		Endless travel in the negative direction of rotation (direct specification of a speed)
ADDITIVE	0x0006		Additive positioning to a calculated target position; a specified position difference is added to the last target position
ABSOLUTE_CHANGE	0x1001		Standard Ext. [ <a href="#">▶ 58</a> ]
RELATIVE_CHANGE	0x1002	Dynamic change of the target position during a travel command to a new relative position (the current changing position value is used here also)	
ADDITIVE_CHANGE	0x1006	Dynamic change of the target position during a travel command to a new additive position (the last target position is used here)	
MODULO_SHORT	0x0105	Modulo [ <a href="#">▶ 60</a> ]	Modulo positioning along the shortest path to the modulo position (positive or negative), calculated by the "Modulo factor" (Index 0x8020:0E)
MODULO_SHORT_EXT	0x0115		Modulo positioning along the shortest path to the modulo position; the "Modulo tolerance window" (Index 0x8020:0F [ <a href="#">▶ 76</a> ]) is ignored
MODULO_PLUS	0x0205		Modulo positioning in the positive direction of rotation to the calculated modulo position
MODULO_PLUS_EXT	0x0215		Modulo positioning in the positive direction of rotation to the calculated modulo position; the "Modulo tolerance window" is ignored
MODULO_MINUS	0x0305		Modulo positioning in the negative direction of rotation to the calculated modulo position
MODULO_MINUS_EXT	0x0315		Modulo positioning in the negative direction of rotation to the calculated modulo position; the "Modulo tolerance window" is ignored
MODULO_CURRENT	0x0405		Modulo positioning in the last direction of rotation to the calculated modulo position
MODULO_CURRENT_EXT	0x0415		Modulo positioning in the last direction of rotation to the calculated modulo position; the "Modulo tolerance window" is ignored
CALI_PLC_CAM	0x6000	Calibration [ <a href="#">▶ 59</a> ]	Start a calibration with cam (digital inputs)
CALI_HW_SYNC	0x6100		Start a calibration with cam and HW sync pulse (C-track)
SET_CALIBRATION	0x6E00		Manually set the terminal to "Calibrated"
SET_CALIBRATION_AUTO	0x6E01		Automatically set the terminal to "Calibrated" on the first rising edge on "Enable"
CLEAR_CALIBRATION	0x6F00		Manually delete the calibration

#### ABSOLUTE

The absolute positioning represents the simplest positioning case. A position B is specified and travelled to from the start point A.

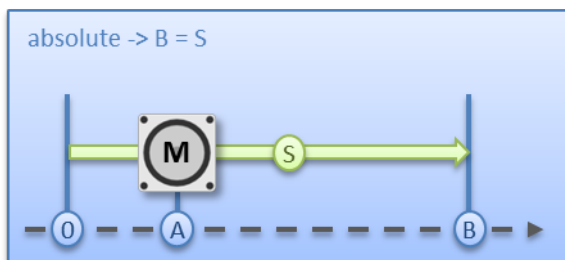

Fig. 34: Absolute positioning

**RELATIVE**

In relative positioning, the user specifies a position delta  $S$ , which is added to the current position  $A$ , producing the target position  $B$ .

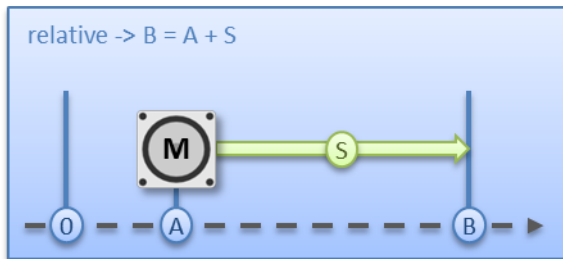

Fig. 35: Relative positioning

**ENDLESS\_PLUS / ENDLESS\_MINUS**

The two start types **ENDLESS\_PLUS** and **ENDLESS\_MINUS** offer the possibility in the *Positioning Interface* to specify a direct motor velocity in order to travel endlessly in the positive or negative direction with the specified accelerations.

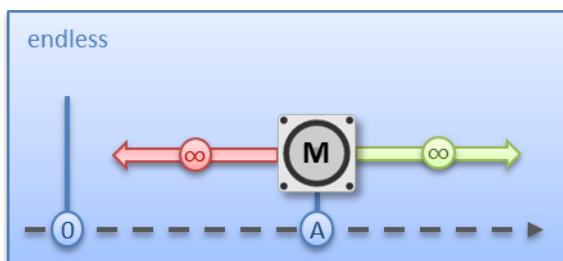

Fig. 36: Endless travel

**ADDITIVE**

For additive positioning, the position delta  $S$  specified by the user is added to the target position  $E$  used for the last travel command in order to calculate the target position  $B$ .

This kind of positioning resembles the relative positioning, but there is a difference. If the last travel command was completed successfully, the new target position is the same. If there was an error, however, be it that the motor entered a stall state or an *Emergency stop* was triggered, the current position is arbitrary and not foreseeable. The user now has the advantage that he can use the last target position for the calculation of the following target position.

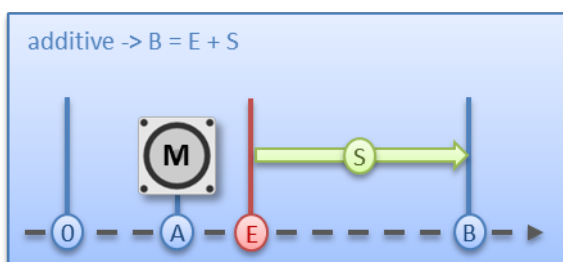

Fig. 37: Additive positioning

**ABSOLUTE\_CHANGE / RELATIVE\_CHANGE / ADDITIVE\_CHANGE**

These three kinds of positioning are completely identical to those described above. The important difference thereby is that the user uses these commands during an active travel command in order to dynamically specify a new target position.

The same rules and conditions apply as to the “normal” start types. ABSOLUTE\_CHANGE and ADDITIVE\_CHANGE are unique in the calculation of the target position i.e. in absolute positioning an absolute position is specified and in additive positioning a position delta is added to the momentarily active target position.

**NOTICE**

**Caution when using the RELATIVE\_CHANGE positioning**

The change by means of RELATIVE\_CHANGE must be used with caution, since the current position of the motor is also used here as the start position. Due to propagation delays in the system, the position indicated in the PDO never corresponds to the actual position of the motor! Therefore a difference to the desired target position always results in the calculation of the transferred position delta.

**● Time of the change of the target position**

**i** A change of the target position cannot take place at an arbitrary point in time. If the calculation of the output parameters shows that the new target position cannot be readily reached, the command is rejected by the terminal and the Command rejected [▶ 54] bit is set. This is the case, for example, at standstill (since the terminal expects a standard positioning here) and in the acceleration phase (since at this point the braking time cannot be calculated yet).

**CALI\_PLC\_CAM / CALI\_HW\_SYNC / SET\_CALIBRATION / SET\_CALIBRATION\_AUTO / CLEAR\_CALIBRATION:**

The simplest calibration case is calibration by cam only (connected to one digital input).

Here, the motor travels in the 1<sup>st</sup> step with velocity 1 (Index 0x8020:09 [▶ 76]) in direction 1 (Index 0x8021:13 [▶ 77]) towards the cam. Subsequently, in the 2<sup>nd</sup> step, it travels with velocity 2 (Index 0x8020:0A [▶ 76]) in direction 2 (Index 0x8021:14 [▶ 77]) away from the cam. After the *In-Target timeout* (Index 0x8020:0C [▶ 76]) has elapsed, the calibration position (Index 0x8020:08 [▶ 76]) is taken on by the terminal as the current position.

**NOTICE**

**Observe the switching hysteresis of the cam switch**

With this simple calibration it must be noted that the position detection of the cam is only exact to a certain degree. The digital inputs are not interrupt-controlled and are "only" polled. The internal propagation delays may therefore result in a system-related position difference.

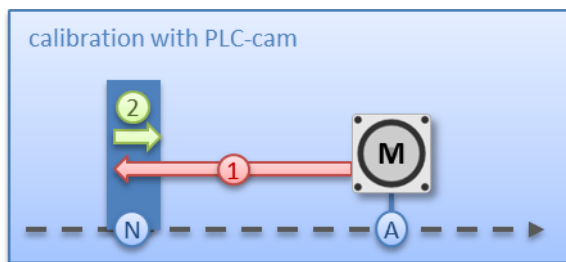

Fig. 38: Calibration with cam

For a more precise calibration, an HW sync pulse (C-track) is used in addition to the cam. This calibration proceeds in exactly the same way as described above, up to the point at which the motor travels away from the cam. The travel is not stopped immediately; instead, the sync pulse is awaited. Subsequently, the *In-Target timeout* runs down again and the calibration position is taken on by the terminal as the current position.

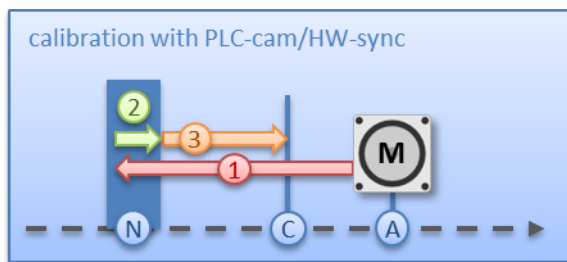

Fig. 39: Calibration with cam and C-track

If calibration by hardware is not possible due to the circumstances of the application, the user can also set the *Calibrated* bit manually or automatically. The manual setting or deletion takes place with the commands `SET_CALIBRATION` and `CLEAR_CALIBRATION`.

It is simpler, however, if the standard start types (Index [0x8021:01 \[▶ 77\]](#)) are set to `SET_CALIBRATION_AUTO`. The *Calibrated* bit will now be set automatically by the first rising edge on *Enable*. The command is conceived only for this purpose; therefore, it does not make sense to use it via the synchronous data exchange.

## 5.4.7 Modulo - general description

### MODULO

The modulo position of the axis is a piece of additional information about the absolute axis position. Modulo positioning represents the required target position in a different way. Contrary to the standard types of positioning, the modulo positioning has several pitfalls, since the desired target position can be interpreted differently.

The modulo positioning refers in principle to the *Modulo factor* (Index [0x8020:0E \[▶ 76\]](#)), which can be set in the CoE. In the following examples, a rotary axis with a "Modulo factor" equivalent to 360 degrees is assumed.

The *Modulo tolerance window* (Index [0x8020:0F \[▶ 76\]](#)) defines a position window around the current modulo target position of the axis. The window width is twice the specified value (set position  $\pm$  tolerance value). A detailed description of the tolerance window is provided below.

The positioning of an axis is always referenced to its current actual position. The actual position of an axis is normally the position moved to with the last travel command. Under certain circumstances (incorrect positioning due to the axis stalling, or a very coarse resolution of the connected encoder), however, a position not expected by the user may arise. If this possibility is not considered, subsequent positioning may lead to unexpected behavior.

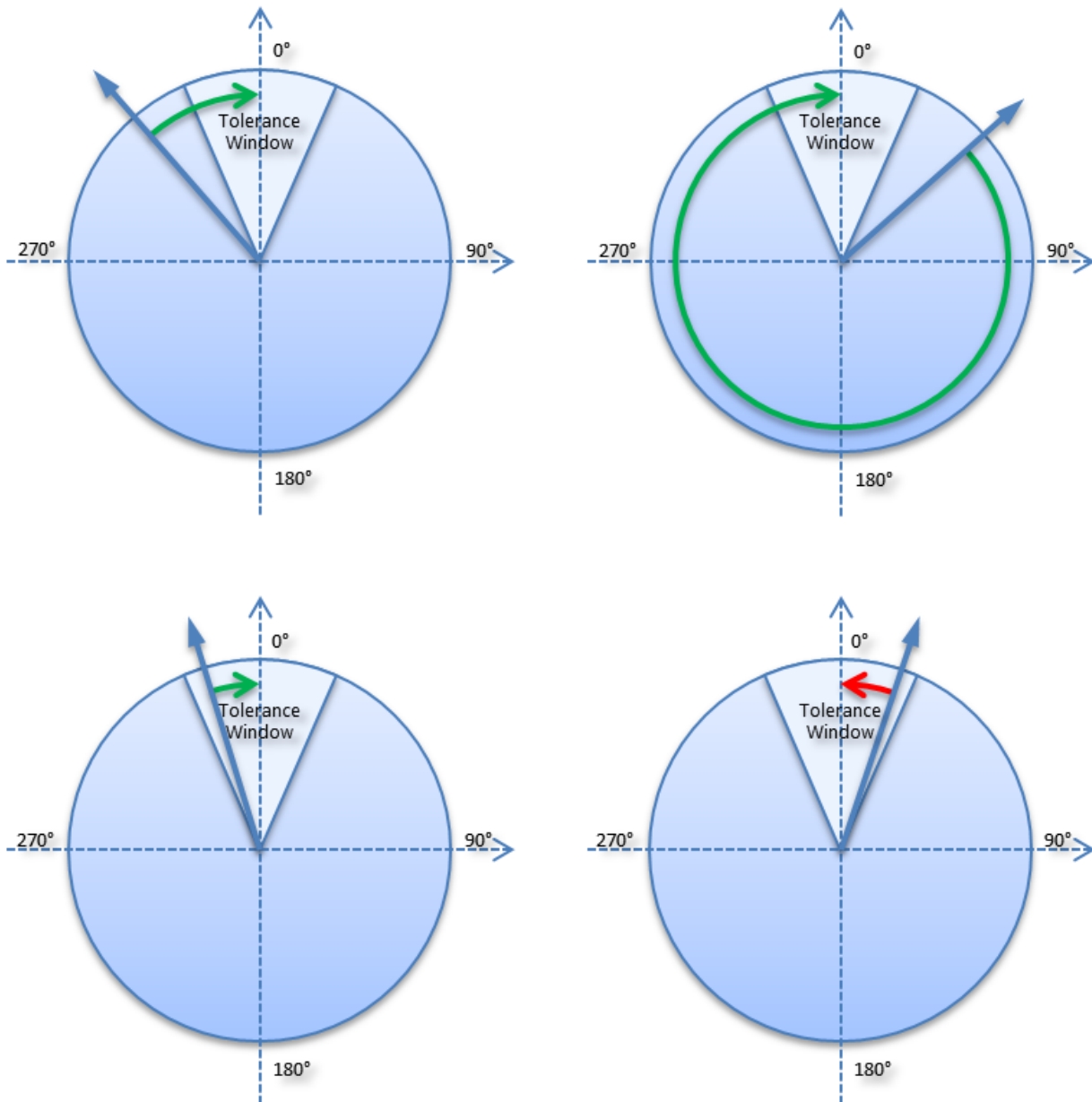

Fig. 40: Effect of the modulo tolerance window - modulo target position 0° in positive direction

**Example**

An axis is positioned to 0°, with the result that subsequently the actual position of the axis is exactly 0°. A further modulo travel command to 360° in *positive direction* results in a full turn, with the subsequent modulo position of the axis of once again being exactly 0°. If the axis comes to a stop somewhat in front of or behind the target position for mechanical reasons, the next travel command does not behave as one would expect. If the actual position lies slightly below 0° (see fig. *Calibration with cam*, below left), a new travel command to 0° in the *positive direction* leads only to a minimal movement. The deviation that arose beforehand is compensated and the position is subsequently exactly 0° once more. If the position lies slightly above 0°, however, the same travel command leads to a full revolution in order to reach the exact position of 0° again. This problem occurs if complete turns by 360° or multiples of 360° were initiated. For positioning to an angle that is significantly different from the current modulo position, the travel command is unambiguous.

In order to solve the problem, a "Modulo tolerance window" (Index 0x8020:0F [▶ 76]) can be parameterized. This ensures that small deviations from the position that are within the window do not lead to different axis behavior. If, for example, a window of 1° is parameterized, in the case described above the axis will behave

identically, as long the actual position is between  $359^\circ$  and  $1^\circ$ . If the position exceeds  $0^\circ$  by less than  $1^\circ$ , the axis is re-positioned in *positive direction* at a modulo start. In both cases, a target position of  $0^\circ$  therefore leads to minimum movement to exactly  $0^\circ$ . A target position of  $360^\circ$  leads to a full turn in both cases.

For values that are within the window range, the modulo tolerance window can therefore lead to movements against the specified direction. For small windows this is usually not a problem, because system deviations between set and actual position are compensated in both directions. This means that the tolerance window may also be used for axes that may only be moved in one direction due to their construction.

### Modulo positioning by less than one turn

Modulo positioning from a starting position to a non-identical target position is unambiguous and requires no special consideration. A modulo target position in the range  $[0 \leq \text{position} < 360]$  reaches the required target in less than one whole turn. No motion occurs if target position and starting position are identical. Target positions of more than  $360^\circ$  lead to one or more full turns before the axis travels to the required target position.

For a movement from  $270^\circ$  to  $0^\circ$ , a modulo target position of  $0^\circ$  (not  $360^\circ$ ) should therefore be specified, because  $360^\circ$  is outside the basic range and would lead to an additional turn.

The modulo positioning distinguishes between three direction specifications: *positive direction*, *negative direction* and *along the shortest path* (*MODULO\_PLUS*, *MODULO\_MINUS*, *MODULO\_SHORT*). For positioning along the shortest path, target positions of more than  $360^\circ$  are not sensible, because the movement towards the target is always direct. In contrast to positive or negative direction, it is therefore not possible to carry out several turns before the axis moves to the target.

#### NOTICE

##### Only basic periods of less than $360^\circ$ are permitted

For modulo positioning with start type "MODULO\_SHORT", only modulo target positions within the basic period (e.g. less than  $360^\circ$ ) are permitted, otherwise an error is returned.

### ● Positioning without the modulo tolerance window

**i** The "Modulo tolerance window" (Index [0x8020:0F | 76](#)) is always taken into account in the "normal" types of modulo positioning. However, this is less desirable in some situations. In order to eliminate this "disadvantage", the comparable start types "MODULO\_SHORT\_EXT", "MODULO\_PLUS\_EXT", "MODULO\_MINUS\_EXT" and "MODULO\_CURRENT\_EXT" can be used, which ignore the modulo tolerance window.

The following table shows examples of modulo positioning with less than one revolution.

Modulo start type	Absolute start position	Modulo target position	Relative travel path	Absolute end position	Modulo end position
MODULO_PLUS	$90^\circ$	$0^\circ$	$270^\circ$	$360^\circ$	$0^\circ$
MODULO_PLUS	$90^\circ$	$360^\circ$	$630^\circ$	$720^\circ$	$0^\circ$
MODULO_PLUS	$90^\circ$	$720^\circ$	$990^\circ$	$1080^\circ$	$0^\circ$
MODULO_MINUS	$90^\circ$	$0^\circ$	$-90^\circ$	$0^\circ$	$0^\circ$
MODULO_MINUS	$90^\circ$	$360^\circ$	$-450^\circ$	$-360^\circ$	$0^\circ$
MODULO_MINUS	$90^\circ$	$720^\circ$	$-810^\circ$	$-720^\circ$	$0^\circ$
MODULO_SHORT	$90^\circ$	$0^\circ$	$-90^\circ$	$0^\circ$	$0^\circ$

### Modulo positioning with full turns

In principle, modulo positioning by one or full turns are no different than positioning to an angle that differs from the starting position. No motion occurs if target position and starting position are identical. For a full turn,  $360^\circ$  has to be added to the starting position. The behavior described in the example shows that special attention must be paid to positionings with whole revolutions. The following table shows positioning examples for a starting position of approximately  $90^\circ$ . The modulo tolerance window (TF) is set to  $1^\circ$  here. Special cases for which the starting position is outside this window are identified.

The following table shows examples of modulo positioning with whole revolutions

Modulo start type	Absolute start position	Modulo target position	Relative travel path	Absolute end position	Modulo end position	Note
MODULO_PLUS	90.00°	90.00°	0.00°	90.00°	90.00°	
MODULO_PLUS	90.90°	90.00°	-0.90°	90.00°	90.00°	
MODULO_PLUS	91.10°	90.00°	358.90°	450.00°	90.00°	outside TF
MODULO_PLUS	89.10°	90.00°	0.90°	90.00°	90.00°	
MODULO_PLUS	88.90°	90.00°	1.10°	90.00°	90.00°	outside TF
MODULO_PLUS	90.00°	450.00	360.00°	450.00°	90.00°	
MODULO_PLUS	90.90°	450.00°	359.10°	450.00°	90.00°	
MODULO_PLUS	91.10°	450.00°	718.90°	810.00°	90.00°	outside TF
MODULO_PLUS	89.10°	450.00°	360.90°	450.00°	90.00°	
MODULO_PLUS	88.90°	450.00°	361.10°	450.00°	90.00°	outside TF
MODULO_PLUS	90.00°	810.00	720.00°	810.00°	90.00°	
MODULO_PLUS	90.90°	810.00	719.10°	810.00°	90.00°	
MODULO_PLUS	91.10°	810.00	1078.90°	1170.00°	90.00°	outside TF
MODULO_PLUS	89.10°	810.00	720.90°	810.00°	90.00°	
MODULO_PLUS	88.90°	810.00	721.10°	810.00°	90.00°	outside TF
MODULO_MINUS	90.00°	90.00°	0.00°	90.00°	90.00°	
MODULO_MINUS	90.90°	90.00°	-0.90°	90.00°	90.00°	
MODULO_MINUS	91.10°	90.00°	-1.10°	90.00°	90.00°	outside TF
MODULO_MINUS	89.10°	90.00°	0.90°	90.00°	90.00°	
MODULO_MINUS	88.90°	90.00°	-358.90°	-270.00°	90.00°	outside TF
MODULO_MINUS	90.00°	450.00°	-360.00°	-270.00°	90.00°	
MODULO_MINUS	90.90°	450.00°	-360.90°	-270.00°	90.00°	
MODULO_MINUS	91.10°	450.00°	-361.10°	-270.00°	90.00°	outside TF
MODULO_MINUS	89.10°	450.00°	-359.10°	-270.00°	90.00°	
MODULO_MINUS	88.90°	450.00°	-718.90°	-630.00°	90.00°	outside TF
MODULO_MINUS	90.00°	810.00°	-720.00°	-630.00°	90.00°	
MODULO_MINUS	90.90°	810.00°	-720.90°	-630.00°	90.00°	
MODULO_MINUS	91.10°	810.00°	-721.10°	-630.00°	90.00°	outside TF
MODULO_MINUS	89.10°	810.00°	-719.10°	-630.00°	90.00°	
MODULO_MINUS	88.90°	810.00°	-1078.90°	-990.00°	90.00°	outside TF



### 5.4.8 Examples of two travel commands with a dynamic change of the target position

Without overrun of the target position

Time	POS Outputs	POS Inputs	Description
t1:	Execute = 1 Target position = 200000 Velocity = 2000 Start type = 0x0001 Acceleration = 1000 Deceleration = 1000	Busy = 1 Accelerate = 1	<ul style="list-style-type: none"> <li>• Specification of the first parameter</li> <li>• Start of the acceleration phase</li> </ul>
t2:		Accelerate = 0	<ul style="list-style-type: none"> <li>• End of the acceleration phase</li> </ul>
t3:	Target position = 100000 Velocity = 1500 Start type = 0x1001 Acceleration = 2000 Deceleration = 2000		<ul style="list-style-type: none"> <li>• Change of the parameters</li> <li>• Activation by new start types</li> </ul>
t4:		Decelerate = 1	<ul style="list-style-type: none"> <li>• Start of the deceleration phase</li> </ul>
t5:	Execute = 0	Busy = 0 In-Target = 1 Decelerate = 0	<ul style="list-style-type: none"> <li>• End of the deceleration phase</li> <li>• Motor is at the new target position</li> </ul>
t6 - t9:			<ul style="list-style-type: none"> <li>• Absolute travel back to the start position 0</li> </ul>

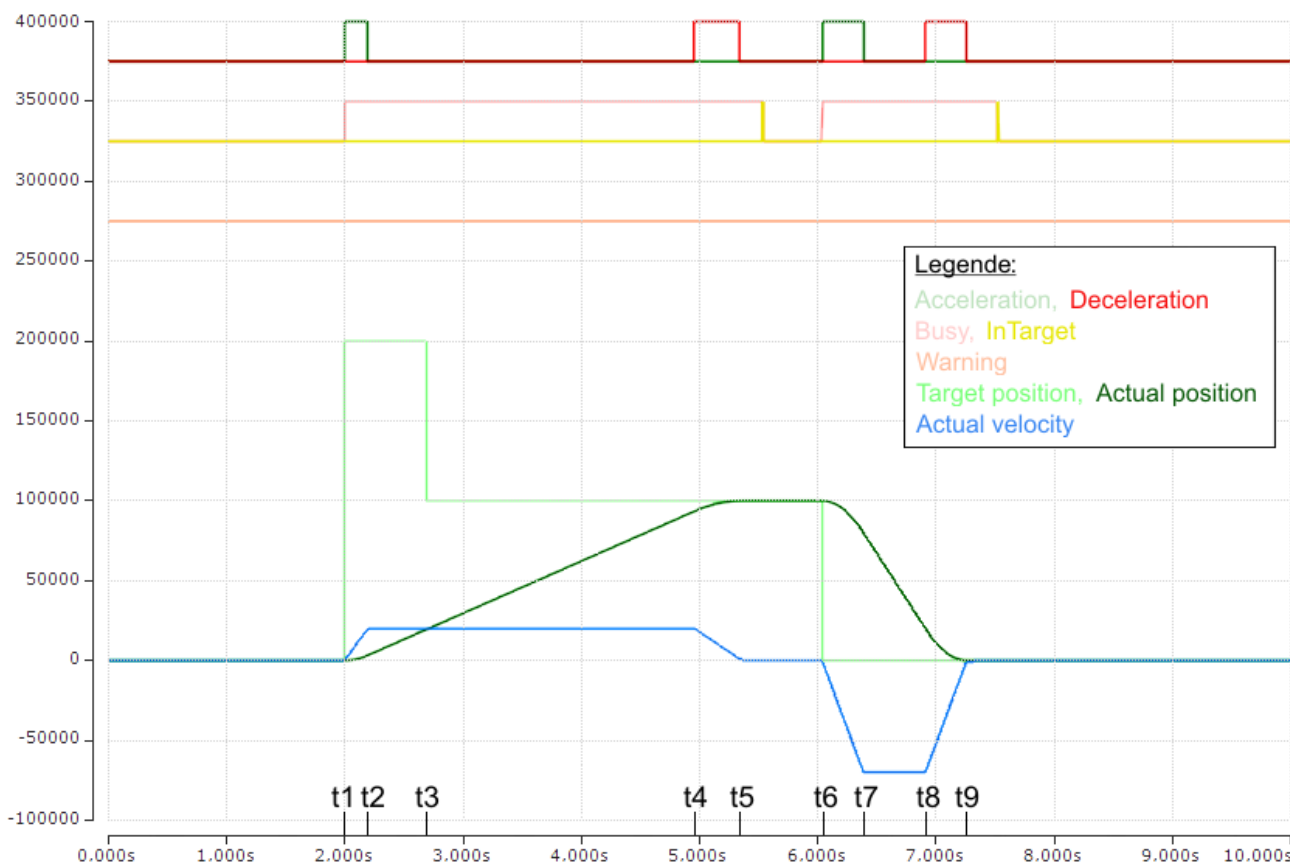

Fig. 41: Scope recording without overrunning the target position

The axis scaling refers only to the positions, not to the speed or the status bits.



With overrun of the target position

Time	POS Outputs	POS Inputs	Description
t1:	Execute = 1 Target position = 200000 Velocity = 5000 Start type = 0x0001 Acceleration = 3000 Deceleration = 5000	Busy = 1 Accelerate = 1	<ul style="list-style-type: none"> <li>• Specification of the 1<sup>st</sup> parameter</li> <li>• Start of the 1<sup>st</sup> acceleration phase</li> </ul>
t2:		Accelerate = 0	<ul style="list-style-type: none"> <li>• End of the 1<sup>st</sup> acceleration phase</li> </ul>
t3:	Target position = 100000 Velocity = 1500 Start type = 0x1001 Acceleration = 1000 Deceleration = 2000	Warning = 1 Decelerate = 1	<ul style="list-style-type: none"> <li>• Change of the parameters</li> <li>• Activation by new start types</li> <li>• Warning of overrunning the target position</li> <li>• Start of the 1<sup>st</sup> deceleration phase</li> </ul>
t4:		Accelerate = 1 Decelerate = 0	<ul style="list-style-type: none"> <li>• End of the 1<sup>st</sup> deceleration phase</li> <li>• Start of the 2<sup>nd</sup> acceleration phase in the opposite direction</li> </ul>
t5:		Accelerate = 0 Decelerate = 1	<ul style="list-style-type: none"> <li>• End of the 2<sup>nd</sup> acceleration phase</li> <li>• Start of the 2<sup>nd</sup> deceleration phase</li> </ul>
t6:	Execute = 0	Busy = 0 In-Target = 1 Decelerate = 0	<ul style="list-style-type: none"> <li>• End of the 2<sup>nd</sup> deceleration phase</li> <li>• Motor is at the new target position</li> </ul>
t7 - t10:			<ul style="list-style-type: none"> <li>• Absolute travel back to the start position 0</li> </ul>

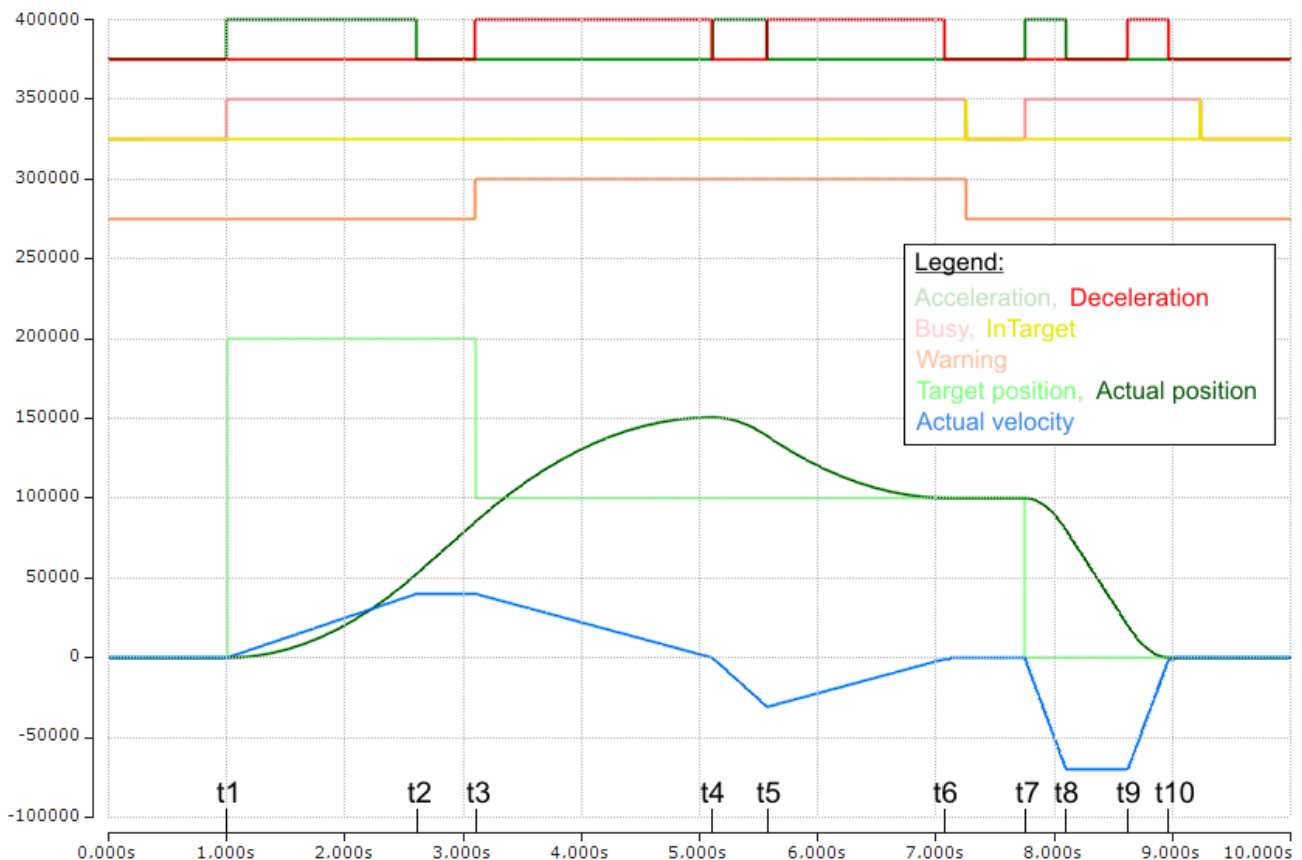

Fig. 42: Scope recording with overrunning of the final target position

The axis scaling refers only to the positions, not to the speed or the status bits.

## 5.5 Application example

### **i** EtherCAT XML Device Description

The display matches that of the CoE objects from the EtherCAT XML Device Description. We recommend downloading the latest XML file from the download area of the [Beckhoff website](https://www.beckhoff.com) and installing it according to installation instructions.

#### Motor control with visualization

 Sample program (<https://infosys.beckhoff.com/content/1033/EP7041/Resources/3696560907/.zip>)

Used Master: TwinCAT 2.11 (for older versions the control loop has to be programmed manually; in this case it is already implemented in the NC).

This application example demonstrates movement of a motor to any position or in continuous mode with the aid of visualization. The velocity, the starting acceleration and the deceleration can be specified.

The sample program consists of two files (PLC file and System Manager file).

First open the PLC file and compile it so that you have the \*.tpy file available that is required for the System Manager.

Please note that you may have to adjust the target platform in the PLC program (default: PC or CX 8x86). If required, you can select the right target platform in the *Resources -> Controller configuration* tab.

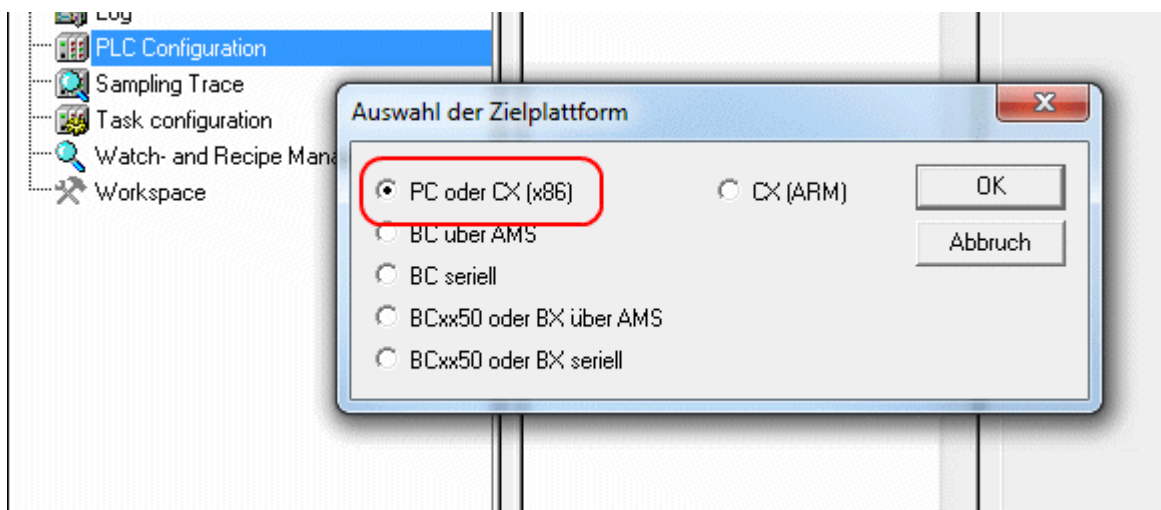

Fig. 43: Selection of the target platform

Please note the following for the System Manager file:

- Start the System Manager in Config mode.
- Please ensure that the I/O configuration matches your actual configuration. In the sample program only one EL7041 is integrated. If further terminals are connected you have to add them or re-scan your configuration.
- You have to adjust the MAC address. To do this, click on your *EtherCAT device*, then select the *Adapter* tab and click on *Search* after the MAC address (see Fig. *Selecting the MAC address*). Select the right adapter.

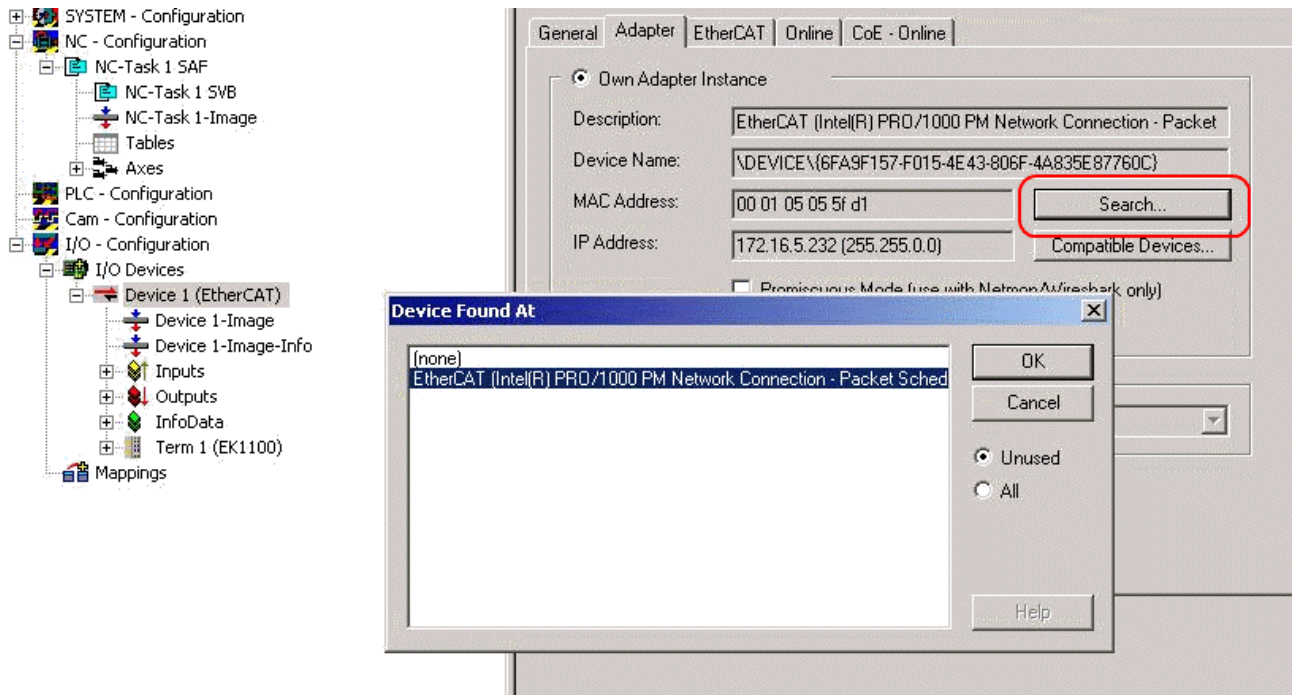

Fig. 44: Selecting the MAC address

- In the PLC configuration you have to adjust the path for the PLC program. Click on the appended PLC program and select the tab *IEC1131* (see Fig. *Changing the PLC path*). Select *Change* and enter the correct path.

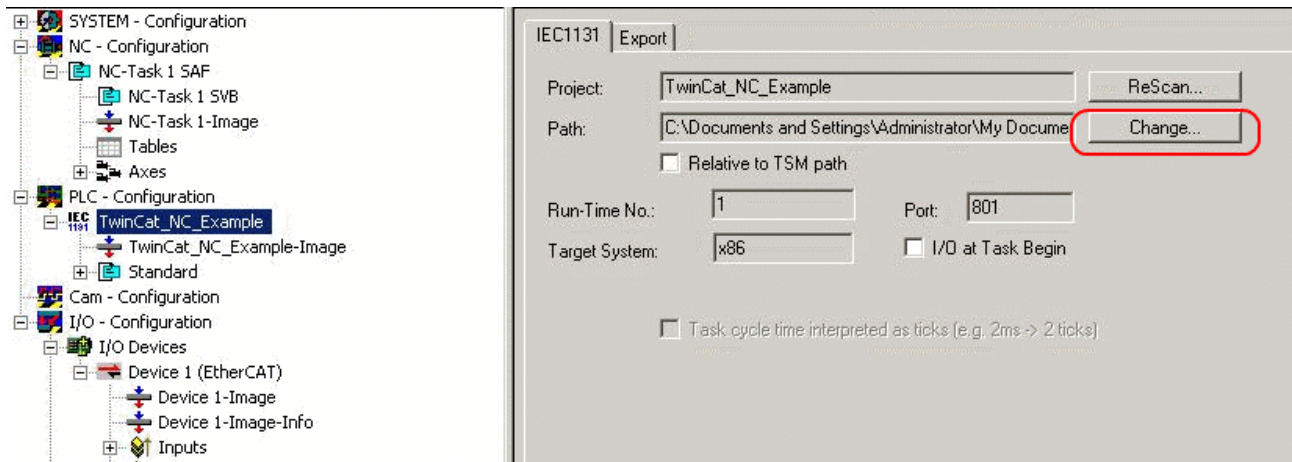

Fig. 45: Changing the PLC path

- Under NC configuration an EL7041 is already linked to the NC. To change the link or add additional devices proceed as described under "Integration into the NC configuration".

The PLC program is configured as follows. The libraries *TcMC.lib* and *TcNC.lib* must be integrated (see Fig. *Required libraries*).

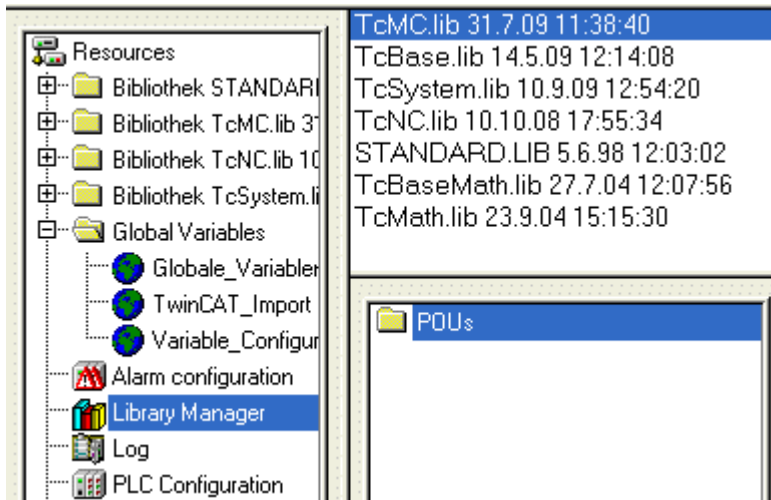

Fig. 46: Required libraries

Once this is done, certain global variables are declared (see Fig. *Global variables*). The data types *PLCTONC\_AXLESTRUCT* and *NCTOPLC\_AXLESTRUCT* deal with the communication between the PLC and the NC.

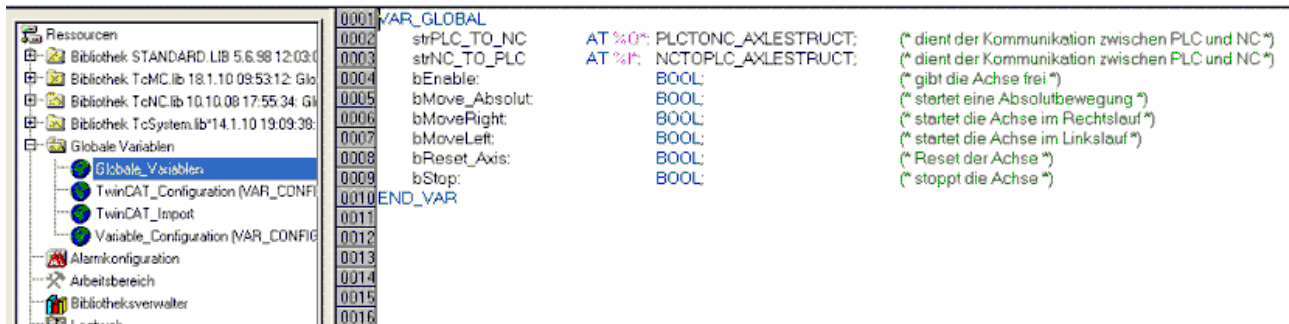

Fig. 47: Global variables

Once the global variables have been declared, programming can commence. Start with declaring local variables (see Fig. *Local variables*).

MC\_Direction is an enumeration type that specifies the direction of movement for the MC\_MoveVelocity function block, which in turn initiates continuous travel of the motor.

An axis reset is carried out with the MC\_Reset function block. Absolute positioning is carried out with the MC\_MoveAbsolute function block. The current axis position can be read with the MC\_ActualPosition function block.

MC\_Power enables the axis; MC\_Stop is required for stopping the axis.

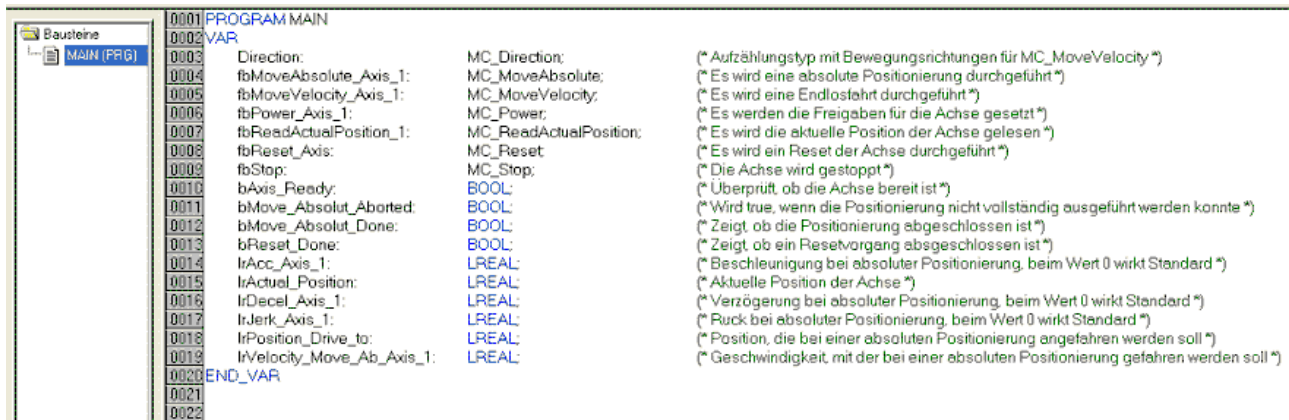

Fig. 48: Local variables

The program code is as follows (see Fig. *Program code*):

```

Bausteine
└─ MAIN (PRG)
0001 (*Freigabesignale werden gesetzt*)
0002 fbPower_Axis_1(
0003   Enable      := bEnable,
0004   Enable_Positive := bEnable,
0005   Enable_Negative := bEnable,
0006   Override    := 100.000,
0007   AxisRefIn   := strNC_TO_PL,
0008   AxisRefOut  := strPLC_TO_NC,
0009   Status      => ,
0010   Error       => , ErrorID      => );
0011
0012 (*Überprüft, ob die Achse bereit ist*)
0013 bAxis_Ready := AxisIsReady(strNC_TO_PL, nStateDWord);
0014
0015 (*Reset der Achse*)
0016 fbReset_Axis(
0017   Execute := bReset_Axis,
0018   Axis    := strNC_TO_PL,
0019   Done    => bReset_Done,
0020   Error   => , ErrorID => );
0021
0022 (*Führt eine Absolutbewegung durch*)
0023 fbMoveAbsolute_Axis_1(
0024   Execute      := bMove_Absolut,
0025   Position     := lPosition_Drive_to,
0026   Velocity     := lVelocity_Move_Ab_Axis_1,
0027   Acceleration := lAcc_Axis_1,
0028   Deceleration := lDecel_Axis_1,
0029   Jerk        := lJerk_Axis_1,
0030   Axis        := strNC_TO_PL,
0031   Done        => bMove_Absolut_Done,
0032   CommandAborted => bMove_Absolut_Aborted,
0033   Error       => , ErrorID      => );
0034
0035 IF fbMoveAbsolute_Axis_1.Done THEN
0036   bMove_Absolut := FALSE;
0037 END_IF
0038
0039 (*Führt eine Endlosbewegung durch*)
0040 IF bMoveRight THEN
0041   Direction := MC_Positive_Direction;
0042 ELSIF bMoveLeft THEN
0043   Direction := MC_Negative_Direction;
0044 END_IF
0045
0046 fbMoveVelocity_Axis_1(
0047   Execute      := bMoveRight OR bMoveLeft,
0048   Velocity     := 1000,
0049   Acceleration := lAcc_Axis_1,
0050   Deceleration := lDecel_Axis_1,
0051   Jerk        := ,
0052   Direction    := Direction,
0053   Axis        := strNC_TO_PL,
0054   InVelocity   => ,
0055   CommandAborted => ,
0056   Error       => , ErrorID      => );
0057
0058 IF bMove_Absolut OR bMoveLeft OR bMoveRight THEN
0059   bStop := FALSE;
0060 ELSE
0061   bStop := TRUE;
0062 END_IF
0063
0064 (*Stoppt die Achse*)
0065 fbStop(
0066   Execute := bStop,
0067   Deceleration := 500,
0068   Jerk := ,
0069   Axis := strNC_TO_PL,
0070   Done => ,
0071   Error => , ErrorID => );
0072
0073 (*Auslesen der aktuellen Position*)
0074 fbReadActualPosition_1(
0075   Enable := TRUE,
0076   Axis := strNC_TO_PL,
0077   Done => ,
0078   Error => ,
0079   ErrorID => ,
0080   Position => lActual_Position);
0081

```

Fig. 49: Program code

The motor can then be operated with the aid of the following visualization (see Fig. *Visualization*).

Press *Enable* to enable the axis. In "Free run mode" you can now use the *Left* or *Right* buttons, and the motor will run with a speed defined under *fbMoveVelocity\_Axis\_1* in the selected direction. In "Absolute mode" you can specify a *Velocity*, *Acceleration*, *Deceleration* and the *Setpoint Position* and initiate the motion with *Start Job*. If no values are entered for *acceleration* and *deceleration* the default value of the NC is used.

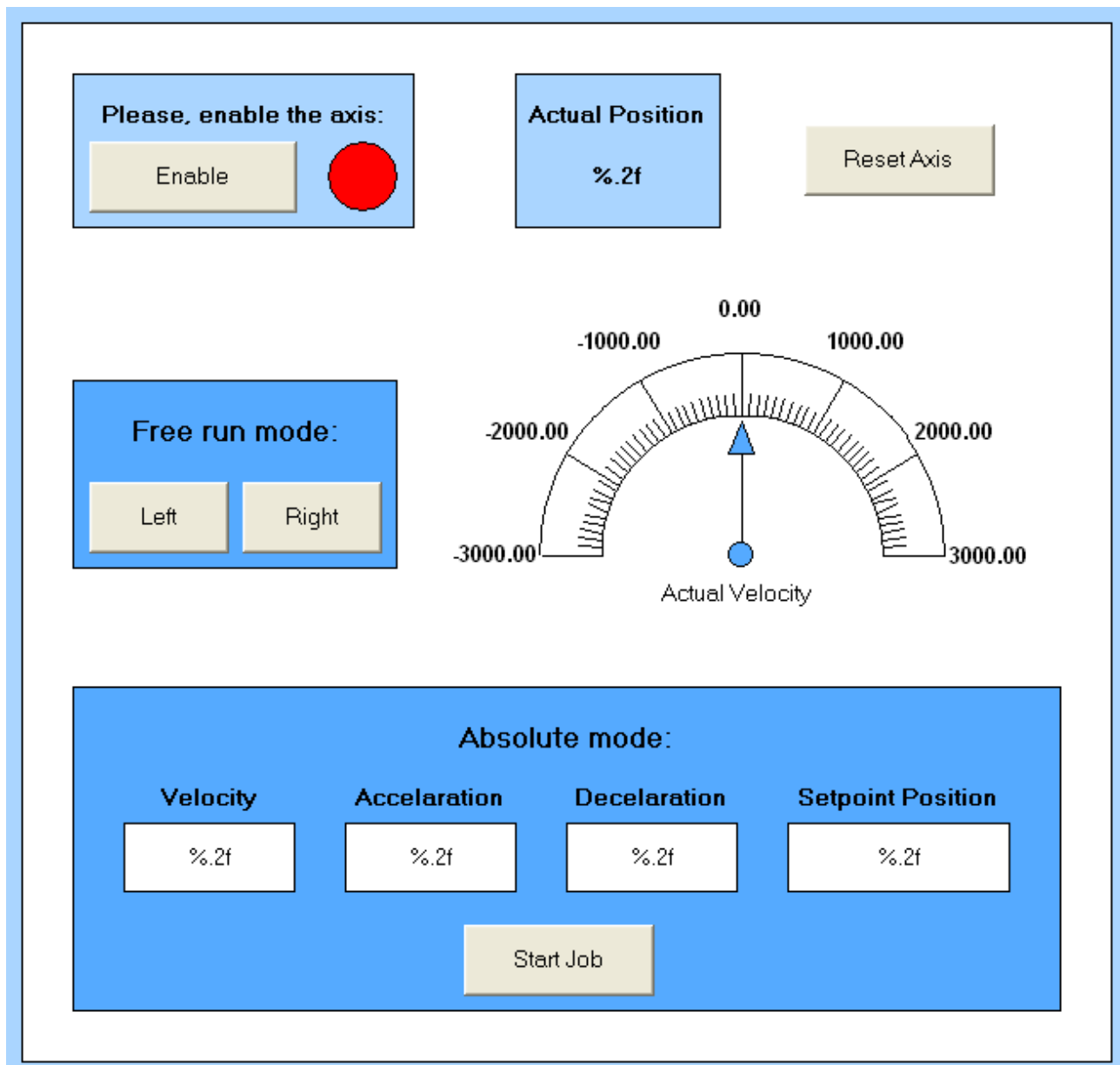

Fig. 50: Visualization

### **i** Information on function blocks and data types

Further information on the function blocks and data types used can be found in the [Beckhoff Information System](#).



## 5.6 Restore the delivery state

You can restore the delivery state of the backup objects as follows:

1. Ensure that TwinCAT is running in Config mode.
2. In CoE object 1011:0 "Restore default parameters" select parameter 1011:01 "Subindex 001".

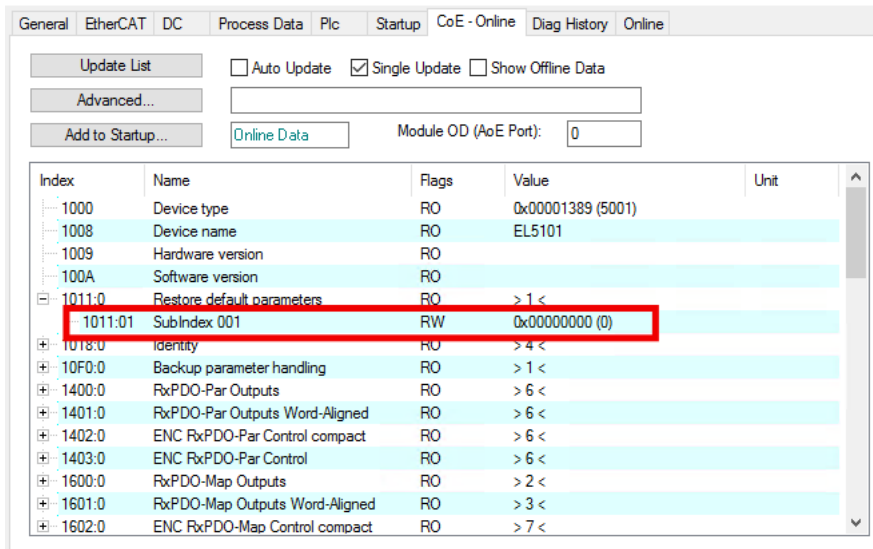

3. Double-click on "Subindex 001".  
⇒ The "Set Value Dialog" dialog box opens.
4. Enter the value 1684107116 in the "Dec" field.  
Alternatively: enter the value 0x64616F6C in the "Hex" field.

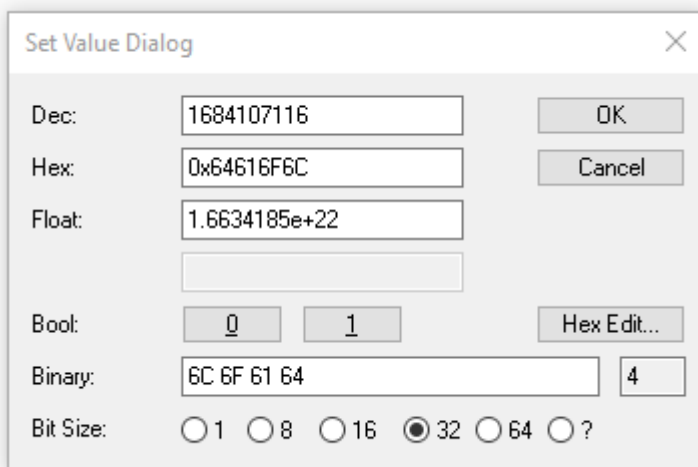

5. Confirm with "OK".  
⇒ All backup objects are reset to the delivery state.

### **i** Alternative restore value

With some older modules the backup objects can be changed with an alternative restore value:

Decimal value: 1819238756

Hexadecimal value: 0x6C6F6164

An incorrect entry for the restore value has no effect.

## 6 CoE objects EP7041-0002, EP7041-1002, EP7041-2002

### 6.1 Object description and parameterization

Applies to [EP7041-0002 \[▶ 12\]](#), [EP7041-1002 \[▶ 12\]](#) and [EP7041-2002 \[▶ 13\]](#).

---

#### ● Parameterization

**i** You can parameterize the box via the "CoE - Online" tab in TwinCAT.

---

#### ● EtherCAT XML Device Description

**i** The presentation matches that of the EtherCAT XML Device Description.  
Recommendation: download the latest XML file from <https://www.beckhoff.com/> and install it according to the installation instructions.

---

#### Introduction

The CoE overview contains objects for different intended applications:

- Objects required for [parameterization during commissioning \[▶ 73\]](#)
- Objects for indicating [internal settings \[▶ 78\]](#) (may be fixed)
- Further [profile-specific objects \[▶ 90\]](#) indicating inputs, outputs and status information

The following section first describes the objects required for normal operation, followed by a complete overview of missing objects.



## 6.1.1 Objects for commissioning

### Index 1011 Restore default parameters

Index (hex)	Name	Meaning	Data type	Flags	Default
1011:0	Restore default parameters	Restore default parameters	UINT8	RO	0x01 (1 <sub>dec</sub> )
1011:01	SubIndex 001	If this object is set to "0x64616F6C" in the set value dialog, all backup objects are reset to their delivery state.	UINT32	RW	0x00000000 (0 <sub>dec</sub> )

### Index 8000 ENC Settings Ch.1

Index (hex)	Name	Meaning	Data type	Flags	Default
8000:0	ENC Settings Ch.1	Maximum subindex	UINT8	RO	0x0F (15 <sub>dec</sub> )
8000:08	Disable filter	Deactivates the input filters.	BOOLEAN	RW	0x00 (0 <sub>dec</sub> )
8000:0A	Enable micro increments	The lower 8 bits of the counter value are extrapolated.	BOOLEAN	RW	0x00 (0 <sub>dec</sub> )
8000:0E	Reversion of rotation	Activates reversion of rotation of the encoder.	BOOLEAN	RW	0x00 (0 <sub>dec</sub> )

### Index 8010 STM Motor Settings Ch.1

Index (hex)	Name	Meaning	Data type	Flags	Default
8010:0	STM Motor Settings Ch.1	Maximum subindex	UINT8	RO	0x11 (17 <sub>dec</sub> )
8010:01	Maximal current	Maximum permanent motor coil current (unit: 1 mA)	UINT16	RW	0x1388 (5000 <sub>dec</sub> )
8010:02	Reduced current	Reduced coil current (reduced torque, unit: 1 mA)	UINT16	RW	0x09C4 (2500 <sub>dec</sub> )
8010:03	Nominal voltage	Nominal voltage (supply voltage) of the motor (unit: 1 mV)	UINT16	RW	0xC350 (50000 <sub>dec</sub> )
8010:04	Motor coil resistance	Internal resistance of a coil (unit: 0.01 ohm)	UINT16	RW	0x0064 (100 <sub>dec</sub> )
8010:05	Motor EMF	Motor countervoltage (unit: 1 mV / 1000 digit)	UINT16	RW	0x0000 (0 <sub>dec</sub> )
8010:06	Motor fullsteps	Motor full steps per revolution	UINT16	RW	0x00C8 (200 <sub>dec</sub> )
8010:07	Encoder increments (4-fold)	Encoder increments per revolution (quadruple evaluation)	UINT16	RW	0x0000 (0 <sub>dec</sub> )
8010:09	Start velocity	Maximum possible start velocity of the motor	UINT16	RW	0x0064 (100 <sub>dec</sub> )
8010:10	Drive on delay time	Switch-on delay of the driver stage (unit: ms)	UINT16	RW	0x0064 (100 <sub>dec</sub> )
8010:11	Drive off delay time	Switch-off delay of the driver stage (unit: ms)	UINT16	RW	0x0096 (150 <sub>dec</sub> )

### Index 8011 STM Controller Settings Ch.1

Index (hex)	Name	Meaning	Data type	Flags	Default
8011:0	STM Controller Settings Ch.1	Maximum subindex	UINT8	RO	0x06 (6 <sub>dec</sub> )
8011:01	Kp factor (curr.)	Kp control factor (proportional component) for the current controller (unit: 0.001)	UINT16	RW	0x00C8 (200 <sub>dec</sub> )
8011:02	Ki factor (curr.)	Ki control factor (integral component) for the current controller (unit: 0.001)	UINT16	RW	0x0002 (2 <sub>dec</sub> )
8011:03	Inner window (curr.)	Inner window for the I component of the current controller (unit: 1%)	UINT8	RW	0x00 (0 <sub>dec</sub> )
8011:05	Outer window (curr.)	Outer window for the I component of the current controller (unit: 1%)	UINT8	RW	0x00 (0 <sub>dec</sub> )
8011:06	Filter cut off frequency (curr.)	Filter limit frequency of the current controller (low-pass, unit: 1 Hz)	UINT16	RW	0x0000 (0 <sub>dec</sub> )
8011:07	Ka factor (curr.)	Ka control factor (acceleration component) for the current controller (unit: 0.001)	UINT16	RW	0x0000 (0 <sub>dec</sub> )
8011:08	Kd factor (curr.)	Kd control factor (deceleration component) for the currentcontroller (unit: 0.001)	UINT16	RW	0x0064 (100 <sub>dec</sub> )

**Index 8012 STM Features Ch.1**

Index (hex)	Name	Meaning	Data type	Flags	Default	
8012:0	STM Features Ch.1	Maximum subindex	UINT8	RO	0x36 (54 <sub>dec</sub> )	
8012:01	Operation mode	Operation mode	BIT4	RW	0x01 (1 <sub>dec</sub> )	
		0				Automatic
		1				Direct velocity
		2				Velocity controller
8012:05	Speed range	Preselection of the speed range	BIT3	RW	0x01 (1 <sub>dec</sub> )	
		0				1000 full steps/second
		1				2000 full steps/second
		2				4000 full steps/second
		3				8000 full steps/second
		4				16000 full steps/second
8012:08	Feedback type	Selection of the feedback system	BIT1	RW	0x01 (1 <sub>dec</sub> )	
		0				External encoder
		1				Internal counter
8012:09	Invert motor polarity	Activates reversal of the motor rotation direction.	BOOLEAN	RW	0x00 (0 <sub>dec</sub> )	
8012:11	Select info data 1	Select "Info data 1" (see 0x6010:11 [► 90])	UINT8	RW	0x03 (3 <sub>dec</sub> )	
		0				Status word
		1				Motor voltage coil A (unit 1 mV)
		2				Motor voltage coil B (unit 1 mV)
		3				Motor current coil A (unit 1 mA)
		4				Motor current coil B (unit 1 mA)
		5				Duty cycle coil A (unit 1%)
		6				Duty cycle coil B (unit 1%)
		7				Current velocity (value range +/- 10000)
		...				reserved
		101				Internal temperature of the driver card
		...				reserved
		103				Control voltage
		104				Motor supply voltage
		...				reserved
		150				Drive – Status word
		151				Drive - State
		152				Drive – Position lag (low word)
		153				Drive – Position lag (high word)
		...				reserved
255	reserved					

Index (hex)	Name	Meaning	Data type	Flags	Default	
8012:19	Select info data 2	Selection "Info data 2"	UINT8	RW	0x04 (4 <sub>dec</sub> )	
		0				Status word
		1				Motor voltage coil A (unit 1 mV)
		2				Motor voltage coil B (unit 1 mV)
		3				Motor current coil A (unit 1 mA)
		4				Motor current coil B (unit 1 mA)
		5				Duty cycle coil A (unit 1%)
		6				Duty cycle coil B (unit 1%)
		7				Current velocity (value range +/- 10000)
		...				reserved
		101				Internal temperature of the driver card
		...				reserved
		103				Control voltage
		104				Motor supply voltage
		...				reserved
		150				Drive – Status word
		151				Drive – State
		152				Drive – Position lag (low word)
		153				Drive – Position lag (high word)
		...				reserved
255	reserved					
8012:30	Invert digital input 1	Inversion of digital input 1	BOOLEAN	RW	0x00 (0 <sub>dec</sub> )	
8012:31	Invert digital input 2	Inversion of digital input 2	BOOLEAN	RW	0x00 (0 <sub>dec</sub> )	
8012:32	Function for input 1	Selection of the function for input 1	BIT4	RW	0x00 (0 <sub>dec</sub> )	
		0				Normal input
		1				Hardware Enable
		2				Plc cam
3	Auto start					
8012:36	Function for input 2	Selection of the function for input 2	BIT4	RW	0x00 (0 <sub>dec</sub> )	
		0				Normal input
		1				Hardware Enable
		2				Plc cam
3	Auto start					
8012:3A	Function for output 1	Selection of the function for output 1	BIT4	RW	0x00 (0 <sub>dec</sub> )	
		0				Normal output
1	Brake If the bit in 0x7010:01 [▶ 91] is set, the output is switched with the delay time set in 0x8010:10 [▶ 73] and 0x8010:11 [▶ 73] of the driver stage.					

**Index 8013 STM Controller Settings 2 Ch.1**

Index (hex)	Name	Meaning	Data type	Flags	Default
8013:0	STM Controller Settings 2 Ch.1	Maximum subindex	UINT8	RO	0x06 (6 <sub>dec</sub> )
8013:01	Kp factor (velo.)	Kp control factor (proportional component) for the velocity controller (unit: 0.001)	UINT16	RW	0x03E8 (1000 <sub>dec</sub> )
8013:02	Ki factor (velo.)	Ki control factor (integral component) for the velocity controller (unit: 0.001)	UINT16	RW	0x0000 (0 <sub>dec</sub> )
8013:03	Inner window (velo.)	Inner window for the I component of the velocity controller (unit: 1%)	UINT8	RW	0x00 (0 <sub>dec</sub> )
8013:05	Outer window (velo.)	Outer window for the I component of the velocity controller (unit: 1%)	UINT8	RW	0x00 (0 <sub>dec</sub> )
8013:06	Filter cut off frequency (velo.)	Filter limit frequency of the velocity controller (low-pass, unit: 1 Hz)	UINT16	RW	0x0000 (0 <sub>dec</sub> )

**Index 8020 POS Settings Ch.1**

Index (hex)	Name	Meaning	Data type	Flags	Default
8020:0	POS Settings Ch.1	Maximum subindex	UINT8	RO	0x10(16 <sub>dec</sub> )
8020:01	Velocity min.	Minimum set velocity (range: 0-10000)	INT16	RW	0x0064 (100 <sub>dec</sub> )
8020:02	Velocity max.	Maximum set velocity (range: 0-10000)	INT16	RW	0x2710 (10000 <sub>dec</sub> )
8020:03	Acceleration pos.	Acceleration in positive direction of rotation (unit: 1 ms)	UINT16	RW	0x03E8 (1000 <sub>dec</sub> )
8020:04	Acceleration neg.	Acceleration in negative direction of rotation (unit: 1 ms)	UINT16	RW	0x03E8 (1000 <sub>dec</sub> )
8020:05	Deceleration pos.	Deceleration in positive direction of rotation (unit: 1 ms)	UINT16	RW	0x03E8 (1000 <sub>dec</sub> )
8020:06	Deceleration neg.	Deceleration in negative direction of rotation (unit: 1 ms)	UINT16	RW	0x03E8 (1000 <sub>dec</sub> )
8020:07	Emergency deceleration	Emergency deceleration (both directions of rotation, unit: 1 ms)	UINT16	RW	0x0064 (100 <sub>dec</sub> )
8020:08	Calibration position	Calibration position	UINT32	RW	0x00000000 (0 <sub>dec</sub> )
8020:09	Calibration velocity (towards plc cam)	Calibration velocity towards the cam (range: 0-10000)	INT16	RW	0x0064 (100 <sub>dec</sub> )
8020:0A	Calibration Velocity (off plc cam)	Calibration velocity away from the cam (range: 0-10000)	INT16	RW	0x000A (10 <sub>dec</sub> )
8020:0B	Target window	Target window	UINT16	RW	0x000A (10 <sub>dec</sub> )
8020:0C	In-Target timeout	Timeout at target position (unit: 1 ms)	UINT16	RW	0x03E8 (1000 <sub>dec</sub> )
8020:0D	Dead time compensation	Dead time compensation (unit: 1 µs)	INT16	RW	0x0032 (50 <sub>dec</sub> )
8020:0E	Modulo factor	Modulo factor/position	UINT32	RW	0x00000000 (0 <sub>dec</sub> )
8020:0F	Modulo tolerance window	Tolerance window for modulo positioning	UINT32	RW	0x00000000 (0 <sub>dec</sub> )
8020:10	Position lag max.	max. position lag	UINT16	RW	0x0000 (0 <sub>dez</sub> )

**Index 8021 POS Features Ch.1**

Index	Name	Meaning	Data type	Flags	Default value
8021:0	POS Features Ch.1	Maximum subindex	UINT8	RO	0x16 (22 <sub>dec</sub> )
8021:01	Start type	permitted values:	UINT16	RW	0x0001 (1 <sub>dec</sub> )
		0: Idle			
		1: Absolute			
		2: Relative			
		3: Endless plus			
		4: Endless minus			
		6: Additive			
		24832: Calibration (Hardware sync)			
		24576: Calibration (Plc cam)			
		28416: Calibration (Clear manual)			
		28160: Calibration (Set manual)			
		28161: Calibration (Set manual auto)			
		1029: Modulo current			
773: Modulo minus					
517: Modulo plus					
261: Modulo short					
8021:11	Time information	permitted values: 0: Elapsed time current drive time since start of the travel command	BIT2	RW	0x00 (0 <sub>dec</sub> )
8021:13	Invert calibration cam search direction	Inversion of the direction of rotation towards the cam	BOOLEAN	RW	0x01 (1 <sub>dec</sub> )
8021:14	Invert sync impulse search direction	Inversion of the direction of rotation away from the cam	BOOLEAN	RW	0x00 (0 <sub>dec</sub> )
8021:15	Emergency stop on position lag error	Triggers an emergency stop if the maximum following error is exceeded	BOOLEAN	RW	0x00 (0 <sub>dec</sub> )
8021:16	Enhanced diag history	Provides detailed messages about the status of the positioning interface in the diag history	BOOLEAN	RW	0x00 (0 <sub>dec</sub> )

**Index FB00 STM Command**

Index (hex)	Name	Meaning	Data type	Flags	Default	
FB00:0	STM Command	Maximum subindex	UINT8	RO	0x03 (3 <sub>dec</sub> )	
FB00:01	Request	Requesting a command	OCTET-STRING[2]	RW	{0}	
		0x8000 Software reset				
FB00:02	Status	Status of the command	UINT8	RO	0x00 (0 <sub>dec</sub> )	
		0				No error, without return value
		1				No error, with return value
		2				With error, without return value
		3				With error, with return value
		...				reserved
255	Command execution active					
FB00:03	Response	Return value of the executed command	OCTET-STRING[4]	RO	{0}	

## 6.1.2 Standardobjekte (0x1000 .. 0x1FFF)

The standard objects have the same meaning for all EtherCAT slaves.

### Index 1000 Device type

Index (hex)	Name	Meaning	Data type	Flags	Default
1000:0	Device type	Device type of the EtherCAT slave: The Lo-Word contains the CoE profile used (5001). The Hi-Word contains the module profile according to the modular device profile.	UINT32	RO	0x00001389 (5001 <sub>dec</sub> )

### Index 1008 Device name

Index (hex)	Name	Meaning	Data type	Flags	Default
1008:0	Device name	Device name of the EtherCAT slave	STRING	RO	EP7041-0002

### Index 1009 Hardware version

Index (hex)	Name	Meaning	Data type	Flags	Default
1009:0	Hardware version	Hardware version of the EtherCAT slave	STRING	RO	00

### Index 100A Software version

Index (hex)	Name	Meaning	Data type	Flags	Default
100A:0	Software version	Firmware version of the EtherCAT slave	STRING	RO	01

### Index 1018 Identity

Index (hex)	Name	Meaning	Data type	Flags	Default
1018:0	Identity	Information for identifying the slave	UINT8	RO	0x04 (4 <sub>dez</sub> )
1018:01	Vendor ID	Vendor ID of the EtherCAT slave	UINT32	RO	0x00000002 (2 <sub>dez</sub> )
1018:02	Product code	Product code of the EtherCAT slave	UINT32	RO	0x1B813052 (461451346 <sub>dez</sub> )
1018:03	Revision	Revision number of the EtherCAT slave; the low word (bit 0-15) indicates the special terminal number, the high word (bit 16-31) refers to the device description	UINT32	RO	0x00100000 (1048576 <sub>dez</sub> )
1018:04	Serial number	Serial number of the EtherCAT slave; the low byte (bit 0-7) of the low word contains the year of production, the high byte (bit 8-15) of the low word contains the week of production, the high word (bit 16-31) is 0	UINT32	RO	0x00000000 (0 <sub>dez</sub> )

### Index 10F0 Backup parameter handling

Index (hex)	Name	Meaning	Data type	Flags	Default
10F0:0	Backup parameter handling	Information for standardized loading and saving of backup entries	UINT8	RO	0x01 (1 <sub>dec</sub> )
10F0:01	Checksum	Checksum across all backup entries of the EtherCAT slave	UINT32	RO	0x00000000 (0 <sub>dec</sub> )

**Index 10F3 Diagnosis History**

Index (hex)	Name	Meaning	Data type	Flags	Default
10F3:0	Diagnosis History	Maximum Subindex	UINT8	RO	0x37 (55 <sub>dec</sub> )
10F3:01	Maximum Messages	Maximum number of stored messages. A maximum of 50 messages can be stored.	UINT8	RO	0x00 (0 <sub>dec</sub> )
10F3:02	Newest Message	Subindex of the latest message	UINT8	RO	0x00 (0 <sub>dec</sub> )
10F3:03	Newest Acknowledged Message	Subindex of the last confirmed message	UINT8	RW	0x00 (0 <sub>dec</sub> )
10F3:04	New Messages Available	Indicates that a new message is available	BOOLEAN	RO	0x00 (0 <sub>dec</sub> )
10F3:05	Flags	not used	UINT16	RW	0x0000 (0 <sub>dec</sub> )
10F3:06	Diagnosis Message 001	Message 1	OCTET-STRING[28]	RO	{0}
...	...	...	...	...	...
10F3:37	Diagnosis Message 050	Message 50	OCTET-STRING[28]	RO	{0}

**Index 10F8 Actual Time Stamp**

Index (hex)	Name	Meaning	Data type	Flags	Default
10F8:0	Actual Time Stamp	Time stamp	UINT64	RO	

**Index 1400 ENC RxPDO-Par Control compact**

Index (hex)	Name	Meaning	Data type	Flags	Default
1400:0	ENC RxPDO-Par Control compact	PDO Parameter RxPDO 1	UINT8	RO	0x06 (6 <sub>dec</sub> )
1400:06	Exclude RxPDOs	Specifies the RxPDOs (index of RxPDO mapping objects) that must not be transferred together with RxPDO 1	OCTET-STRING[6]	RO	01 16 00 00 00 00

**Index 1401 ENC RxPDO-Par Control**

Index (hex)	Name	Meaning	Data type	Flags	Default
1401:0	ENC RxPDO-Par Control	PDO Parameter RxPDO 2	UINT8	RO	0x06 (6 <sub>dec</sub> )
1401:06	Exclude RxPDOs	Specifies the RxPDOs (index of RxPDO mapping objects) that must not be transferred together with RxPDO 2	OCTET-STRING[6]	RO	00 16 00 00 00 00

**Index 1403 STM RxPDO-Par Position**

Index (hex)	Name	Meaning	Data type	Flags	Default
1403:0	STM RxPDO-Par Position	PDO Parameter RxPDO 4	UINT8	RO	0x06 (6 <sub>dec</sub> )
1403:06	Exclude RxPDOs	Specifies the RxPDOs (index of RxPDO mapping objects) that must not be transferred together with RxPDO 4	OCTET-STRING[6]	RO	04 16 05 16 06 16

**Index 1404 STM RxPDO-Par Velocity**

Index (hex)	Name	Meaning	Data type	Flags	Default
1404:0	STM RxPDO-Par Velocity	PDO Parameter RxPDO 5	UINT8	RO	0x06 (6 <sub>dec</sub> )
1404:06	Exclude RxPDOs	Specifies the RxPDOs (index of RxPDO mapping objects) that must not be transferred together with RxPDO 5	OCTET-STRING[6]	RO	03 16 05 16 06 16

**Index 1405 POS RxPDO-Par Control compact**

Index (hex)	Name	Meaning	Data type	Flags	Default
1405:0	POS RxPDO-Par Control compact	PDO Parameter RxPDO 6	UINT8	RO	0x06 (6 <sub>dec</sub> )
1405:06	Exclude RxPDOs	Specifies the RxPDOs (index of RxPDO mapping objects) that must not be transferred together with RxPDO 6	OCTET-STRING[6]	RO	03 16 04 16 06 16

**Index 1406 POS RxPDO-Par Control**

Index (hex)	Name	Meaning	Data type	Flags	Default
1406:0	POS RxPDO-Par Control	PDO Parameter RxPDO 7	UINT8	RO	0x06 (6 <sub>dec</sub> )
1406:06	Exclude RxPDOs	Specifies the RxPDOs (index of RxPDO mapping objects) that must not be transferred together with RxPDO 7	OCTET-STRING[6]	RO	03 16 04 16 05 16

**Index 1407 POS RxPDO-Par Control 2**

Index (hex)	Name	Meaning	Data type	Flags	Default
1407:0	POS RxPDO-Par Control	PDO Parameter RxPDO 8	UINT8	RO	0x06 (6 <sub>dec</sub> )
1407:06	Exclude RxPDOs	Specifies the RxPDOs (index of RxPDO mapping objects) that must not be transferred together with RxPDO 8	OCTET-STRING[6]	RO	03 16 04 16 05 16

**Index 1600 ENC RxPDO-Map Control compact**

Index (hex)	Name	Meaning	Data type	Flags	Default
1600:0	ENC RxPDO-Map Control compact	PDO Mapping RxPDO 1	UINT8	RO	0x07 (7 <sub>dec</sub> )
1600:01	SubIndex 001	1. PDO Mapping entry (object 0x7000 (ENC Outputs Ch.1), entry 0x01 (Enable latch C))	UINT32	RO	0x7000:01, 1
1600:02	SubIndex 002	2. PDO Mapping entry (object 0x7000 (ENC Outputs Ch.1), entry 0x02 (Enable latch extern on positive edge))	UINT32	RO	0x7000:02, 1
1600:03	SubIndex 003	3. PDO Mapping entry (object 0x7000 (ENC Outputs Ch.1), entry 0x03 (Set counter))	UINT32	RO	0x7000:03, 1
1600:04	SubIndex 004	4. PDO Mapping entry (object 0x7000 (ENC Outputs Ch.1), entry 0x04 (Enable latch extern on negative edge))	UINT32	RO	0x7000:04, 1
1600:05	SubIndex 005	5. PDO Mapping entry (4 bits align)	UINT32	RO	0x0000:00, 4
1600:06	SubIndex 006	6. PDO Mapping entry (8 bits align)	UINT32	RO	0x0000:00, 8
1600:07	SubIndex 007	7. PDO Mapping entry (object 0x7000 (ENC Outputs Ch.1), entry 0x11 (Set counter value))	UINT32	RO	0x7000:11, 16

**Index 1601 ENC RxPDO-Map Control**

Index (hex)	Name	Meaning	Data type	Flags	Default
1601:0	ENC RxPDO-Map Control	PDO Mapping RxPDO 2	UINT8	RO	0x07 (7 <sub>dec</sub> )
1601:01	SubIndex 001	1. PDO Mapping entry (object 0x7000 (ENC Outputs Ch.1), entry 0x01 (Enable latch C))	UINT32	RO	0x7000:01, 1
1601:02	SubIndex 002	2. PDO Mapping entry (object 0x7000 (ENC Outputs Ch.1), entry 0x02 (Enable latch extern on positive edge))	UINT32	RO	0x7000:02, 1
1601:03	SubIndex 003	3. PDO Mapping entry (object 0x7000 (ENC Outputs Ch.1), entry 0x03 (Set counter))	UINT32	RO	0x7000:03, 1
1601:04	SubIndex 004	4. PDO Mapping entry (object 0x7000 (ENC Outputs Ch.1), entry 0x04 (Enable latch extern on negative edge))	UINT32	RO	0x7000:04, 1
1601:05	SubIndex 005	5. PDO Mapping entry (4 bits align)	UINT32	RO	0x0000:00, 4
1601:06	SubIndex 006	6. PDO Mapping entry (8 bits align)	UINT32	RO	0x0000:00, 8
1601:07	SubIndex 007	7. PDO Mapping entry (object 0x7000 (ENC Outputs Ch.1), entry 0x11 (Set counter value))	UINT32	RO	0x7000:11, 32



**Index 1602 STM RxPDO-Map Control**

Index (hex)	Name	Meaning	Data type	Flags	Default
1602:0	STM RxPDO-Map Control	PDO Mapping RxPDO 3	UINT8	RO	0x07 (7 <sub>dec</sub> )
1602:01	SubIndex 001	1. PDO Mapping entry (object 0x7010 (STM Outputs Ch.1), entry 0x01 (Enable))	UINT32	RO	0x7010:01, 1
1602:02	SubIndex 002	2. PDO Mapping entry (object 0x7010 (STM Outputs Ch.1), entry 0x02 (Reset))	UINT32	RO	0x7010:02, 1
1602:03	SubIndex 003	3. PDO Mapping entry (object 0x7010 (STM Outputs Ch.1), entry 0x03 (Reduce torque))	UINT32	RO	0x7010:03, 1
1602:04	SubIndex 004	4. PDO Mapping entry (5 bits align)	UINT32	RO	0x0000:00, 5
1602:05	SubIndex 005	5. PDO Mapping entry (3 bits align)	UINT32	RO	0x0000:00, 3
1602:06	SubIndex 006	6. PDO Mapping entry (object 0x7010 (STM Outputs Ch.1), entry 0x0C (Digital output 1))	UINT32	RO	0x7010:0C, 1
1602:07	SubIndex 007	7. PDO Mapping entry (4 bits align)	UINT32	RO	0x0000:00, 4

**Index 1603 STM RxPDO-Map Position**

Index (hex)	Name	Meaning	Data type	Flags	Default
1603:0	STM RxPDO-Map Position	PDO Mapping RxPDO 4	UINT8	RO	0x01 (1 <sub>dec</sub> )
1603:01	SubIndex 001	1. PDO Mapping entry (object 0x7010 (STM Outputs Ch.1), entry 0x11 (Position))	UINT32	RO	0x7010:11, 32

**Index 1604 STM RxPDO-Map Velocity**

Index (hex)	Name	Meaning	Data type	Flags	Default
1604:0	STM RxPDO-Map Velocity	PDO Mapping RxPDO 5	UINT8	RO	0x01 (1 <sub>dec</sub> )
1604:01	SubIndex 001	1. PDO Mapping entry (object 0x7010 (STM Outputs Ch.1), entry 0x21 (Velocity))	UINT32	RO	0x7010:21, 16

**Index 1605 POS RxPDO-Map Control compact**

Index (hex)	Name	Meaning	Data type	Flags	Default
1605:0	POS RxPDO-Map Control compact	PDO Mapping RxPDO 6	UINT8	RO	0x05 (5 <sub>dec</sub> )
1605:01	SubIndex 001	1. PDO Mapping entry (object 0x7020 (POS Outputs Ch.1), entry 0x01 (Execute))	UINT32	RO	0x7020:01, 1
1605:02	SubIndex 002	2. PDO Mapping entry (object 0x7020 (POS Outputs Ch.1), entry 0x02 (Emergency stop))	UINT32	RO	0x7020:02, 1
1605:03	SubIndex 003	3. PDO Mapping entry (6 bits align)	UINT32	RO	0x0000:00, 6
1605:04	SubIndex 004	4. PDO Mapping entry (8 bits align)	UINT32	RO	0x0000:00, 8
1605:05	SubIndex 005	5. PDO Mapping entry (object 0x7020 (POS Outputs Ch.1), entry 0x11 (Target position))	UINT32	RO	0x7020:11, 32

**Index 1606 POS RxPDO-Map Control**

Index (hex)	Name	Meaning	Data type	Flags	Default
1606:0	POS RxPDO-Map Control	PDO Mapping RxPDO 7	UINT8	RO	0x09 (9 <sub>dec</sub> )
1606:01	SubIndex 001	1. PDO Mapping entry (object 0x7020 (POS Outputs Ch.1), entry 0x01 (Execute))	UINT32	RO	0x7020:01, 1
1606:02	SubIndex 002	2. PDO Mapping entry (object 0x7020 (POS Outputs Ch.1), entry 0x02 (Emergency stop))	UINT32	RO	0x7020:02, 1
1606:03	SubIndex 003	3. PDO Mapping entry (6 bits align)	UINT32	RO	0x0000:00, 6
1606:04	SubIndex 004	4. PDO Mapping entry (8 bits align)	UINT32	RO	0x0000:00, 8
1606:05	SubIndex 005	5. PDO Mapping entry (object 0x7020 (POS Outputs Ch.1), entry 0x11 (Target position))	UINT32	RO	0x7020:11, 32
1606:06	SubIndex 006	6. PDO Mapping entry (object 0x7020 (POS Outputs Ch.1), entry 0x21 (Velocity))	UINT32	RO	0x7020:21, 16
1606:07	SubIndex 007	7. PDO Mapping entry (object 0x7020 (POS Outputs Ch.1), entry 0x22 (Start type))	UINT32	RO	0x7020:22, 16
1606:08	SubIndex 008	8. PDO Mapping entry (object 0x7020 (POS Outputs Ch.1), entry 0x23 (Acceleration))	UINT32	RO	0x7020:23, 16
1606:09	SubIndex 009	9. PDO Mapping entry (object 0x7020 (POS Outputs Ch.1), entry 0x24 (Deceleration))	UINT32	RO	0x7020:24, 16

**Index 1607 POS RxPDO-Map Control 2**

Index (hex)	Name	Meaning	Data type	Flags	Default
1607:0	POS RxPDO-Map Control 2	PDO Mapping RxPDO 8	UINT8	RO	0x09 (9 <sub>dez</sub> )
1607:01	SubIndex 001	1. PDO Mapping entry	UINT32	RO	0x0000:00,2
1607:02	SubIndex 002	2. PDO Mapping entry (object 0x7020 (POS Outputs 2 Ch.1), entry 0x03 (Enable auto start))	UINT32	RO	0x7020:03, 1
1607:03	SubIndex 003	3. PDO Mapping entry (6 bits align)	UINT32	RO	0x0000:00,5
1607:04	SubIndex 004	4. PDO Mapping entry (8 bits align)	UINT32	RO	0x0000:00, 8
1607:05	SubIndex 005	5. PDO Mapping entry (object 0x7021 (POS Outputs 2 Ch.1), entry 0x11 (Target position))	UINT32	RO	0x7021:11, 32
1607:06	SubIndex 006	6. PDO Mapping entry (object 0x7021 (POS Outputs 2 Ch.1), entry 0x21 (Velocity))	UINT32	RO	0x7021:21, 16
1607:07	SubIndex 007	7. PDO Mapping entry (object 0x7021 (POS Outputs 2 Ch.1), entry 0x22 (Start type))	UINT32	RO	0x7021:22, 16
1607:08	SubIndex 008	8. PDO Mapping entry (object 0x7021 (POS Outputs 2 Ch.1), entry 0x23 (Acceleration))	UINT32	RO	0x7021:23, 16
1607:09	SubIndex 009	9. PDO Mapping entry (object 0x7021 (POS Outputs 2 Ch.1), entry 0x24 (Deceleration))	UINT32	RO	0x7021:24, 16

**Index 1800 ENC TxPDO-Par Status compact**

Index (hex)	Name	Meaning	Data type	Flags	Default
1800:0	ENC TxPDO-Par Status compact	PDO Parameter TxPDO 1	UINT8	RO	0x06 (6 <sub>dec</sub> )
1800:06	Exclude TxPDOs	Specifies the TxPDOs (index of TxPDO mapping objects) that must not be transferred together with TxPDO 1	OCTET-STRING[2]	RO	01 1A

**Index 1801 ENC TxPDO-Par Status**

Index (hex)	Name	Meaning	Data type	Flags	Default
1801:0	ENC TxPDO-Par Status	PDO Parameter TxPDO 2	UINT8	RO	0x06 (6 <sub>dec</sub> )
1801:06	Exclude TxPDOs	Specifies the TxPDOs (index of TxPDO mapping objects) that must not be transferred together with TxPDO 2	OCTET-STRING[2]	RO	00 1A

**Index 1805 POS TxPDO-Par Status compact**

Index (hex)	Name	Meaning	Data type	Flags	Default
1805:0	POS TxPDO-Par Status compact	PDO Parameter TxPDO 7	UINT8	RO	0x06 (6 <sub>dec</sub> )
1805:06	Exclude TxPDOs	Specifies the RxPDOs (index of RxPDO mapping objects) that must not be transferred together with RxPDO 7	OCTET-STRING[2]	RO	06 1A

**Index 1806 POS TxPDO-Par Status**

Index (hex)	Name	Meaning	Data type	Flags	Default
1806:0	POS TxPDO-Par Status	PDO Parameter TxPDO 8	UINT8	RO	0x06 (6 <sub>dez</sub> )
1806:06	Exclude TxPDOs	Specifies the RxPDOs (index of RxPDO mapping objects) that must not be transferred together with RxPDO 8	OCTET-STRING[2]	RO	05 1A

**Index 1A00 ENC TxPDO-Map Status compact**

Index (hex)	Name	Meaning	Data type	Flags	Default
1A00:0	ENC TxPDO-Map Status compact	PDO Mapping TxPDO 1	UINT8	RO	0x11 (17 <sub>dec</sub> )
1A00:01	SubIndex 001	1. PDO Mapping entry (object 0x6000 (ENC Inputs Ch.1), entry 0x01 (Latch C valid))	UINT32	RO	0x6000:01, 1
1A00:02	SubIndex 002	2. PDO Mapping entry (object 0x6000 (ENC Inputs Ch.1), entry 0x02 (Latch extern valid))	UINT32	RO	0x6000:02, 1
1A00:03	SubIndex 003	3. PDO Mapping entry (object 0x6000 (ENC Inputs Ch.1), entry 0x03 (Set counter done))	UINT32	RO	0x6000:03, 1
1A00:04	SubIndex 004	4. PDO Mapping entry (object 0x6000 (ENC Inputs Ch.1), entry 0x04 (Counter underflow))	UINT32	RO	0x6000:04, 1
1A00:05	SubIndex 005	5. PDO Mapping entry (object 0x6000 (ENC Inputs Ch.1), entry 0x05 (Counter overflow))	UINT32	RO	0x6000:05, 1
1A00:06	SubIndex 006	6. PDO Mapping entry (2 bits align)	UINT32	RO	0x0000:00, 2
1A00:07	SubIndex 007	7. PDO Mapping entry (object 0x6000 (ENC Inputs Ch.1), entry 0x08 (Extrapolation stall))	UINT32	RO	0x6000:08, 1
1A00:08	SubIndex 008	8. PDO Mapping entry (object 0x6000 (ENC Inputs Ch.1), entry 0x09 (Status of input A))	UINT32	RO	0x6000:09, 1
1A00:09	SubIndex 009	9. PDO Mapping entry (object 0x6000 (ENC Inputs Ch.1), entry 0x0A (Status of input B))	UINT32	RO	0x6000:0A, 1
1A00:0A	SubIndex 010	10. PDO Mapping entry (object 0x6000 (ENC Inputs Ch.1), entry 0x0B (Status of input C))	UINT32	RO	0x6000:0B, 1
1A00:0B	SubIndex 011	11. PDO Mapping entry (1 bits align)	UINT32	RO	0x0000:00, 1
1A00:0C	SubIndex 012	12. PDO Mapping entry (object 0x6000 (ENC Inputs Ch.1), entry 0x0D (Status of extern latch))	UINT32	RO	0x6000:0D, 1
1A00:0D	SubIndex 013	13. PDO Mapping entry (object 0x1C32 (SM output parameter), entry 0x20 (Sync error))	UINT32	RO	0x1C32:20, 1
1A00:0E	SubIndex 014	14. PDO Mapping entry (1 bits align)	UINT32	RO	0x0000:00, 1
1A00:0F	SubIndex 015	15. PDO Mapping entry (object 0x1800 (ENC TxPDO-Par Status compact), entry 0x09)	UINT32	RO	0x1800:09, 1
1A00:10	SubIndex 016	16. PDO Mapping entry (object 0x6000 (ENC Inputs Ch.1), entry 0x11 (Counter value))	UINT32	RO	0x6000:11, 16
1A00:11	SubIndex 017	17. PDO Mapping entry (object 0x6000 (ENC Inputs Ch.1), entry 0x12 (Latch value))	UINT32	RO	0x6000:12, 16

**Index 1A01 ENC TxPDO-Map Status**

Index (hex)	Name	Meaning	Data type	Flags	Default
1A01:0	ENC TxPDO-Map Status	PDO Mapping TxPDO 2	UINT8	RO	0x11 (17 <sub>dec</sub> )
1A01:01	SubIndex 001	1. PDO Mapping entry (object 0x6000 (ENC Inputs Ch.1), entry 0x01 (Latch C valid))	UINT32	RO	0x6000:01, 1
1A01:02	SubIndex 002	2. PDO Mapping entry (object 0x6000 (ENC Inputs Ch.1), entry 0x02 (Latch extern valid))	UINT32	RO	0x6000:02, 1
1A01:03	SubIndex 003	3. PDO Mapping entry (object 0x6000 (ENC Inputs Ch.1), entry 0x03 (Set counter done))	UINT32	RO	0x6000:03, 1
1A01:04	SubIndex 004	4. PDO Mapping entry (object 0x6000 (ENC Inputs Ch.1), entry 0x04 (Counter underflow))	UINT32	RO	0x6000:04, 1
1A01:05	SubIndex 005	5. PDO Mapping entry (object 0x6000 (ENC Inputs Ch.1), entry 0x05 (Counter overflow))	UINT32	RO	0x6000:05, 1
1A01:06	SubIndex 006	6. PDO Mapping entry (2 bits align)	UINT32	RO	0x0000:00, 2
1A01:07	SubIndex 007	7. PDO Mapping entry (object 0x6000 (ENC Inputs Ch.1), entry 0x08 (Extrapolation stall))	UINT32	RO	0x6000:08, 1
1A01:08	SubIndex 008	8. PDO Mapping entry (object 0x6000 (ENC Inputs Ch.1), entry 0x09 (Status of input A))	UINT32	RO	0x6000:09, 1
1A01:09	SubIndex 009	9. PDO Mapping entry (object 0x6000 (ENC Inputs Ch.1), entry 0x0A (Status of input B))	UINT32	RO	0x6000:0A, 1
1A01:0A	SubIndex 010	10. PDO Mapping entry (object 0x6000 (ENC Inputs Ch.1), entry 0x0B (Status of input C))	UINT32	RO	0x6000:0B, 1
1A01:0B	SubIndex 011	11. PDO Mapping entry (1 bits align)	UINT32	RO	0x0000:00, 1
1A01:0C	SubIndex 012	12. PDO Mapping entry (object 0x6000 (ENC Inputs Ch.1), entry 0x0D (Status of extern latch))	UINT32	RO	0x6000:0D, 1
1A01:0D	SubIndex 013	13. PDO Mapping entry (object 0x1C32 (SM output parameter), entry 0x20 (Sync error))	UINT32	RO	0x1C32:20, 1
1A01:0E	SubIndex 014	14. PDO Mapping entry (1 bits align)	UINT32	RO	0x0000:00, 1
1A01:0F	SubIndex 015	15. PDO Mapping entry (object 0x1801 (ENC TxPDO-Par Status), entry 0x09)	UINT32	RO	0x1801:09, 1
1A01:10	SubIndex 016	16. PDO Mapping entry (object 0x6000 (ENC Inputs Ch.1), entry 0x11 (Counter value))	UINT32	RO	0x6000:11, 32
1A01:11	SubIndex 017	17. PDO Mapping entry (object 0x6000 (ENC Inputs Ch.1), entry 0x12 (Latch value))	UINT32	RO	0x6000:12, 32

**Index 1A02 ENC TxPDO-Map Timest. compact**

Index (hex)	Name	Meaning	Data type	Flags	Default
1A02:0	ENC TxPDO-Map Timest. compact	PDO Mapping TxPDO 3	UINT8	RO	0x01 (1 <sub>dec</sub> )
1A02:01	SubIndex 001	1. PDO Mapping entry (object 0x6000 (ENC Inputs Ch.1), entry 0x16 (Timestamp))	UINT32	RO	0x6000:16, 32

**Index 1A03 STM TxPDO-Map Status**

Index (hex)	Name	Meaning	Data type	Flags	Default
1A03:0	STM TxPDO-Map Status	PDO Mapping TxPDO 4	UINT8	RO	0x0E (14 <sub>dec</sub> )
1A03:01	SubIndex 001	1. PDO Mapping entry (object 0x6010 (STM Inputs Ch.1), entry 0x01 (Ready to enable))	UINT32	RO	0x6010:01, 1
1A03:02	SubIndex 002	2. PDO Mapping entry (object 0x6010 (STM Inputs Ch.1), entry 0x02 (Ready))	UINT32	RO	0x6010:02, 1
1A03:03	SubIndex 003	3. PDO Mapping entry (object 0x6010 (STM Inputs Ch.1), entry 0x03 (Warning))	UINT32	RO	0x6010:03, 1
1A03:04	SubIndex 004	4. PDO Mapping entry (object 0x6010 (STM Inputs Ch.1), entry 0x04 (Error))	UINT32	RO	0x6010:04, 1
1A03:05	SubIndex 005	5. PDO Mapping entry (object 0x6010 (STM Inputs Ch.1), entry 0x05 (Moving positive))	UINT32	RO	0x6010:05, 1
1A03:06	SubIndex 006	6. PDO Mapping entry (object 0x6010 (STM Inputs Ch.1), entry 0x06 (Moving negative))	UINT32	RO	0x6010:06, 1
1A03:07	SubIndex 007	7. PDO Mapping entry (object 0x6010 (STM Inputs Ch.1), entry 0x07 (Torque reduced))	UINT32	RO	0x6010:07, 1
1A03:08	SubIndex 008	8. PDO Mapping entry (1 bits align)	UINT32	RO	0x6010:08, 1
1A03:09	SubIndex 009	9. PDO Mapping entry (3 bits align)	UINT32	RO	0x0000:00, 3
1A03:0A	SubIndex 010	10. PDO Mapping entry (object 0x6010 (STM Inputs Ch.1), entry 0x0C (Digital input 1))	UINT32	RO	0x6010:0C, 1
1A03:0B	SubIndex 011	11. PDO Mapping entry (object 0x6010 (STM Inputs Ch.1), entry 0x0D (Digital input 2))	UINT32	RO	0x6010:0D, 1
1A03:0C	SubIndex 012	12. PDO Mapping entry (object 0x1C32 (SM output parameter), entry 0x20 (Sync error))	UINT32	RO	0x6010:0E, 1
1A03:0D	SubIndex 013	13. PDO Mapping entry (1 bits align)	UINT32	RO	0x0000:00, 1
1A03:0E	SubIndex 014	14. PDO Mapping entry (object 0x1803, entry 0x09)	UINT32	RO	0x6010:10, 1

**Index 1A04 STM TxPDO-Map Synchron info data**

Index (hex)	Name	Meaning	Data type	Flags	Default
1A04:0	STM TxPDO-Map Synchron info data	PDO Mapping TxPDO 5	UINT8	RO	0x02 (2 <sub>dec</sub> )
1A04:01	SubIndex 001	1. PDO Mapping entry (object 0x6010 (STM Inputs Ch.1), entry 0x11 (Info data 1))	UINT32	RO	0x6010:11, 16
1A04:02	SubIndex 002	2. PDO Mapping entry (object 0x6010 (STM Inputs Ch.1), entry 0x12 (Info data 2))	UINT32	RO	0x6010:12, 16

**Index 1A05 POS TxPDO-Map Status compact**

Index (hex)	Name	Meaning	Data type	Flags	Default
1A05:0	POS TxPDO-Map Status compact	PDO Mapping TxPDO 7	UINT8	RO	0x09 (9 <sub>dec</sub> )
1A05:01	SubIndex 001	1. PDO Mapping entry (object 0x6020 (POS Inputs Ch.1), entry 0x01 (Busy))	UINT32	RO	0x6020:01, 1
1A05:02	SubIndex 002	2. PDO Mapping entry (object 0x6020 (POS Inputs Ch.1), entry 0x02 (In-Target))	UINT32	RO	0x6020:02, 1
1A05:03	SubIndex 003	3. PDO Mapping entry (object 0x6020 (POS Inputs Ch.1), entry 0x03 (Warning))	UINT32	RO	0x6020:03, 1
1A05:04	SubIndex 004	4. PDO Mapping entry (object 0x6020 (POS Inputs Ch.1), entry 0x04 (Error))	UINT32	RO	0x6020:04, 1
1A05:05	SubIndex 005	5. PDO Mapping entry (object 0x6020 (POS Inputs Ch.1), entry 0x05 (Calibrated))	UINT32	RO	0x6020:05, 1
1A05:06	SubIndex 006	6. PDO Mapping entry (object 0x6020 (POS Inputs Ch.1), entry 0x06 (Accelerate))	UINT32	RO	0x6020:06, 1
1A05:07	SubIndex 007	7. PDO Mapping entry (object 0x6020 (POS Inputs Ch.1), entry 0x07 (Decelerate))	UINT32	RO	0x6020:07, 1
1A05:08	SubIndex 008	8. PDO Mapping entry (1 bits align)	UINT32	RO	0x0000:00, 1
1A05:09	SubIndex 009	9. PDO Mapping entry (8 bits align)	UINT32	RO	0x0000:00, 8

**Index 1A06 POS TxPDO-Map Status**

Index (hex)	Name	Meaning	Data type	Flags	Default
1A06:0	POS TxPDO-Map Status compact	PDO Mapping TxPDO 7	UINT8	RO	0x09 (9 <sub>dez</sub> )
1A06:01	SubIndex 001	1. PDO Mapping entry (object 0x6020 (POS Inputs Ch.1), entry 0x01 (Busy))	UINT32	RO	0x6020:01, 1
1A06:02	SubIndex 002	2. PDO Mapping entry (object 0x6020 (POS Inputs Ch.1), entry 0x02 (In-Target))	UINT32	RO	0x6020:02, 1
1A06:03	SubIndex 003	3. PDO Mapping entry (object 0x6020 (POS Inputs Ch.1), entry 0x03 (Warning))	UINT32	RO	0x6020:03, 1
1A06:04	SubIndex 004	4. PDO Mapping entry (object 0x6020 (POS Inputs Ch.1), entry 0x04 (Error))	UINT32	RO	0x6020:04, 1
1A06:05	SubIndex 005	5. PDO Mapping entry (object 0x6020 (POS Inputs Ch.1), entry 0x05 (Calibrated))	UINT32	RO	0x6020:05, 1
1A06:06	SubIndex 006	6. PDO Mapping entry (object 0x6020 (POS Inputs Ch.1), entry 0x06 (Accelerate))	UINT32	RO	0x6020:06, 1
1A06:07	SubIndex 007	7. PDO Mapping entry (object 0x6020 (POS Inputs Ch.1), entry 0x07 (Decelerate))	UINT32	RO	0x6020:07, 1
1A06:08	SubIndex 008	8. PDO Mapping entry (object 0x6020 (POS Inputs Ch.1), entry 0x08 (Ready to execute))	UINT32	RO	0x6020:08, 1
1A06:09	SubIndex 009	9. PDO Mapping entry (8 bits align)	UINT32	RO	0x0000:00, 8
1A06:0A	SubIndex 010	10. PDO Mapping entry (object 0x6020 (POS Inputs Ch.1), entry 0x11 (Actual position))	UINT32	RO	0x6020:11, 32
1A06:0B	SubIndex 011	11. PDO Mapping entry (object 0x6020 (POS Inputs Ch.1), entry 0x21 (Actual velocity))	UINT32	RO	0x6020:21, 16
1A06:0C	SubIndex 012	12. PDO Mapping entry (object 0x6020 (POS Inputs Ch.1), entry 0x22 (Actual drive time))	UINT32	RO	0x6020:22, 32

**Index 1A07 STM TxPDO-Map Internal position**

Index (hex)	Name	Meaning	Data type	Flags	Default
1A07:0	POS TxPDO-Map Status	PDO Mapping TxPDO 8	UINT8	RO	0x01 (1 <sub>dez</sub> )
1A07:01	SubIndex 001	1. PDO Mapping entry (object 0x6010 (STM Inputs Ch.1), entry 0x14 (Internal position))	UINT32	RO	0x6010:14, 32

**Index 1A08 STM TxPDO-Map External position**

Index (hex)	Name	Meaning	Data type	Flags	Default
1A08:0	POS TxPDO-Map Status	PDO Mapping TxPDO 8	UINT8	RO	0x01 (1 <sub>dez</sub> )
1A08:01	SubIndex 001	1. PDO Mapping entry (object 0x6010 (STM Inputs Ch.1), entry 0x15 (External position))	UINT32	RO	0x6010:15, 32

**Index 1A09 POS TxPDO-Map Actual position lag**

Index (hex)	Name	Meaning	Data type	Flags	Default
1A09:0	POS TxPDO-Map Status	PDO Mapping TxPDO 8	UINT8	RO	0x01 (1 <sub>dez</sub> )
1A09:01	SubIndex 001	1. PDO Mapping entry (object 0x6020 (STM Inputs Ch.1), entry 0x23 (Actual position lag))	UINT32	RO	0x6020:23, 32

**Index 1C00 Sync manager type**

Index (hex)	Name	Meaning	Data type	Flags	Default
1C00:0	Sync manager type	Benutzung der Sync Manager	UINT8	RO	0x04 (4 <sub>dez</sub> )
1C00:01	SubIndex 001	Sync-Manager Type Channel 1: Mailbox Write	UINT8	RO	0x01 (1 <sub>dez</sub> )
1C00:02	SubIndex 002	Sync-Manager Type Channel 2: Mailbox Read	UINT8	RO	0x02 (2 <sub>dez</sub> )
1C00:03	SubIndex 003	Sync-Manager Type Channel 3: Process Data Write (Outputs)	UINT8	RO	0x03 (3 <sub>dez</sub> )
1C00:04	SubIndex 004	Sync-Manager Type Channel 4: Process Data Read (Inputs)	UINT8	RO	0x04 (4 <sub>dez</sub> )

**Index 1C12 RxPDO assign**

Index (hex)	Name	Meaning	Data type	Flags	Default
1C12:0	RxPDO assign	PDO Assign Outputs	UINT8	RW	0x03 (3 <sub>dez</sub> )
1C12:01	Subindex 001	1. allocated RxPDO (contains the index of the associated RxPDO mapping object)	UINT16	RW	0x1600 (5632 <sub>dez</sub> )
1C12:02	Subindex 002	2. allocated RxPDO (contains the index of the associated RxPDO mapping object)	UINT16	RW	0x1602 (5634 <sub>dez</sub> )
1C12:03	Subindex 003	3. allocated RxPDO (contains the index of the associated RxPDO mapping object)	UINT16	RW	0x1604 (5636 <sub>dez</sub> )

**Index 1C13 TxPDO assign**

Index (hex)	Name	Meaning	Data type	Flags	Default
1C13:0	TxPDO assign	PDO Assign Inputs	UINT8	RW	0x02 (2 <sub>dez</sub> )
1C13:01	Subindex 001	1. allocated TxPDO (contains the index of the associated TxPDO mapping object)	UINT16	RW	0x1A00 (6656 <sub>dez</sub> )
1C13:02	Subindex 002	2. allocated TxPDO (contains the index of the associated TxPDO mapping object)	UINT16	RW	0x1A03 (6659 <sub>dez</sub> )
1C13:03	Subindex 003	3. allocated TxPDO (contains the index of the associated TxPDO mapping object)	UINT16	RW	0x0000 (0 <sub>dez</sub> )
1C13:04	Subindex 004	4. allocated TxPDO (contains the index of the associated TxPDO mapping object)	UINT16	RW	0x0000 (0 <sub>dez</sub> )
1C13:05	Subindex 005	5. allocated TxPDO (contains the index of the associated TxPDO mapping object)	UINT16	RW	0x0000 (0 <sub>dez</sub> )
1C13:06	Subindex 006	6. allocated TxPDO (contains the index of the associated TxPDO mapping object)	UINT16	RW	0x0000 (0 <sub>dez</sub> )
1C13:07	Subindex 007	7. allocated TxPDO (contains the index of the associated TxPDO mapping object)	UINT16	RW	0x0000 (0 <sub>dez</sub> )
1C13:08	Subindex 008	8. allocated TxPDO (contains the index of the associated TxPDO mapping object)	UINT16	RW	0x0000 (0 <sub>dez</sub> )



## Index 1C32 SM output parameter

Index (hex)	Name	Meaning	Data type	Flags	Default
1C32:0	SM output parameter	Synchronization parameters for the outputs	UINT8	RO	0x20 (32 <sub>dec</sub> )
1C32:01	Sync mode	Current synchronization mode: <ul style="list-style-type: none"> <li>0: Free Run</li> <li>1: Synchron with SM 2 Event</li> <li>2: DC-Mode - Synchron with SYNC0 Event</li> <li>3: DC-Mode - Synchron with SYNC1 Event</li> </ul>	UINT16	RW	0x0001 (1 <sub>dec</sub> )
1C32:02	Cycle time	Cycle time (in ns): <ul style="list-style-type: none"> <li>Free Run: Cycle time of the local timer</li> <li>Synchron with SM 2 Event: Master cycle time</li> <li>DC-Mode: SYNC0/SYNC1 Cycle Time</li> </ul>	UINT32	RW	0x000F4240 (1000000 <sub>dec</sub> )
1C32:03	Shift time	Time between SYNC0 event and output of the outputs (in ns, DC mode only)	UINT32	RO	0x00000000 (0 <sub>dec</sub> )
1C32:04	Sync modes supported	Supported synchronization modes: <ul style="list-style-type: none"> <li>Bit 0 = 1: free run is supported</li> <li>Bit 1 = 1: Synchronous with SM 2 event is supported</li> <li>Bit 2-3 = 01: DC mode is supported</li> <li>Bit 4-5 = 10: Output shift with SYNC1 event (only DC mode)</li> <li>Bit 14 = 1: dynamic times (measurement through writing of 0x1C32:08 [▶ 88])</li> </ul>	UINT16	RO	0xC007 (49159 <sub>dec</sub> )
1C32:05	Minimum cycle time	Minimum cycle time (in ns)	UINT32	RO	0x000249F0 (150000 <sub>dec</sub> )
1C32:06	Calc and copy time	Minimum time between SYNC0 and SYNC1 event (in ns, DC mode only)	UINT32	RO	0x00000000 (0 <sub>dec</sub> )
1C32:08	Command	<ul style="list-style-type: none"> <li>0: Measurement of the local cycle time is stopped</li> <li>1: Measurement of the local cycle time is started</li> </ul> <p>The entries 0x1C32:03 [▶ 88], 0x1C32:05 [▶ 88], 0x1C32:06 [▶ 88], 0x1C32:09 [▶ 88], 0x1C33:03 [▶ 89], 0x1C33:06 [▶ 88], 0x1C33:09 [▶ 89] are updated with the maximum measured values. For a subsequent measurement the measured values are reset</p>	UINT16	RW	0x0000 (0 <sub>dec</sub> )
1C32:09	Delay time	Time between SYNC1 event and output of the outputs (in ns, DC mode only)	UINT32	RO	0x00000000 (0 <sub>dec</sub> )
1C32:0B	SM event missed counter	Number of missed SM events in OPERATIONAL (DC mode only)	UINT16	RO	0x0000 (0 <sub>dec</sub> )
1C32:0C	Cycle exceeded counter	Number of occasions the cycle time was exceeded in OPERATIONAL (cycle was not completed in time or the next cycle began too early)	UINT16	RO	0x0000 (0 <sub>dec</sub> )
1C32:0D	Shift too short counter	Number of occasions that the interval between SYNC0 and SYNC1 event was too short (DC mode only)	UINT16	RO	0x0000 (0 <sub>dec</sub> )
1C32:20	Sync error	The synchronization was not correct in the last cycle (outputs were output too late; DC mode only)	BOOLEAN	RO	0x00 (0 <sub>dec</sub> )



**Index 1C33 SM input parameter**

Index (hex)	Name	Meaning	Data type	Flags	Default
1C33:0	SM input parameter	Synchronization parameters for the inputs	UINT8	RO	0x20 (32 <sub>dec</sub> )
1C33:01	Sync mode	Current synchronization mode: <ul style="list-style-type: none"> <li>• 0: Free Run</li> <li>• 1: Synchronous with SM 3 Event (no outputs available)</li> <li>• 2: DC - Synchron with SYNC0 Event</li> <li>• 3: DC - Synchron with SYNC1 Event</li> <li>• 34: Synchronous with SM 2 Event (outputs available)</li> </ul>	UINT16	RW	0x0022 (34 <sub>dec</sub> )
1C33:02	Cycle time	as <a href="#">0x1C32:02</a> [ <a href="#">▶ 88</a> ]	UINT32	RW	0x000F4240 (1000000 <sub>dec</sub> )
1C33:03	Shift time	Time between SYNC0 event and reading of the inputs (in ns, only DC mode)	UINT32	RO	0x00000000 (0 <sub>dec</sub> )
1C33:04	Sync modes supported	Supported synchronization modes: <ul style="list-style-type: none"> <li>• Bit 0: free run is supported</li> <li>• Bit 1: Synchronous with SM 2 Event is supported (outputs available)</li> <li>• Bit 1: Synchronous with SM 3 Event is supported (no outputs available)</li> <li>• Bit 2-3 = 01: DC mode is supported</li> <li>• Bit 4-5 = 01: Input shift through local event (outputs available)</li> <li>• Bit 4-5 = 10: Input shift with SYNC1 event (no outputs available)</li> <li>• Bit 14 = 1: dynamic times (measurement through writing of <a href="#">0x1C32:08</a> [<a href="#">▶ 88</a>] or <a href="#">0x1C33:08</a> [<a href="#">▶ 89</a>])</li> </ul>	UINT16	RO	0xC007 (49159 <sub>dec</sub> )
1C33:05	Minimum cycle time	as <a href="#">0x1C32:05</a> [ <a href="#">▶ 88</a> ]	UINT32	RO	0x000249F0 (150000 <sub>dec</sub> )
1C33:06	Calc and copy time	Time between reading of the inputs and availability of the inputs for the master (in ns, only DC mode)	UINT32	RO	0x00000000 (0 <sub>dec</sub> )
1C33:08	Command	as <a href="#">0x1C32:08</a> [ <a href="#">▶ 88</a> ]	UINT16	RW	0x0000 (0 <sub>dec</sub> )
1C33:09	Delay time	Time between SYNC1 event and reading of the inputs (in ns, only DC mode)	UINT32	RO	0x00000000 (0 <sub>dec</sub> )
1C33:0B	SM event missed counter	as <a href="#">0x1C32:11</a> [ <a href="#">▶ 88</a> ]	UINT16	RO	0x0000 (0 <sub>dec</sub> )
1C33:0C	Cycle exceeded counter	as <a href="#">0x1C32:12</a> [ <a href="#">▶ 88</a> ]	UINT16	RO	0x0000 (0 <sub>dec</sub> )
1C33:0D	Shift too short counter	as <a href="#">0x1C32:13</a> [ <a href="#">▶ 88</a> ]	UINT16	RO	0x0000 (0 <sub>dec</sub> )
1C33:20	Sync error	as <a href="#">0x1C32:32</a> [ <a href="#">▶ 88</a> ]	BOOLEAN	RO	0x00 (0 <sub>dec</sub> )

### 6.1.3 Profile-specific objects (0x6000 .. 0xFFFF)

The profile-specific objects have the same meaning for all EtherCAT slaves that support the profile 5001.

#### Index 6000 ENC Inputs Ch.1

Index (hex)	Name	Meaning	Data type	Flags	Default
6000:0	ENC Inputs Ch.1	Maximum subindex	UINT8	RO	0x16 (22 <sub>dec</sub> )
6000:01	Latch C valid	The counter value was latched with the C track.	BOOLEAN	RO	0x00 (0 <sub>dec</sub> )
6000:02	Latch extern valid	The counter value was stored via the external latch.	BOOLEAN	RO	0x00 (0 <sub>dec</sub> )
6000:03	Set counter done	The counter was set.	BOOLEAN	RO	0x00 (0 <sub>dec</sub> )
6000:04	Counter underflow	Counter underflow.	BOOLEAN	RO	0x00 (0 <sub>dec</sub> )
6000:05	Counter overflow	Counter overflow.	BOOLEAN	RO	0x00 (0 <sub>dec</sub> )
6000:08	Extrapolation stall	The extrapolated part of the counter is invalid	BOOLEAN	RO	0x00 (0 <sub>dec</sub> )
6000:09	Status of input A	Status of the A-input.	BOOLEAN	RO	0x00 (0 <sub>dec</sub> )
6000:0A	Status of input B	Status of the B-input.	BOOLEAN	RO	0x00 (0 <sub>dec</sub> )
6000:0B	Status of input C	Status of the C-input.	BOOLEAN	RO	0x00 (0 <sub>dec</sub> )
6000:0D	Status of extern latch	Status of the ext. latch input.	BOOLEAN	RO	0x00 (0 <sub>dec</sub> )
6000:0E	Sync error	The Sync error bit is only required for DC mode. It indicates whether a synchronization error has occurred during the previous cycle.	BOOLEAN	RO	0x00 (0 <sub>dec</sub> )
6000:10	TxPDO Toggle	The TxPDO toggle is toggled by the slave when the data of the associated TxPDO is updated.	BOOLEAN	RO	0x00 (0 <sub>dec</sub> )
6000:11	Counter value	The counter value.	UINT32	RO	0x00000000 (0 <sub>dec</sub> )
6000:12	Latch value	The latch value.	UINT32	RO	0x00000000 (0 <sub>dec</sub> )
6000:16	Timestamp	Time stamp of the last counter change.	UINT32	RO	0x00000000 (0 <sub>dec</sub> )

#### Index 6010 STM Inputs Ch.1

Index (hex)	Name	Meaning	Data type	Flags	Default
6010:0	STM Inputs Ch.1	Maximum subindex	UINT8	RO	0x12 (18 <sub>dec</sub> )
6010:01	Ready to enable	Driver stage is ready for enabling	BOOLEAN	RO	0x00 (0 <sub>dec</sub> )
6010:02	Ready	Driver stage is ready for operation	BOOLEAN	RO	0x00 (0 <sub>dec</sub> )
6010:03	Warning	A warning has occurred	BOOLEAN	RO	0x00 (0 <sub>dec</sub> )
6010:04	Error	An error has occurred (see index 0xA010 [▶ 95])	BOOLEAN	RO	0x00 (0 <sub>dec</sub> )
6010:05	Moving positive	Motor turns in positive direction	BOOLEAN	RO	0x00 (0 <sub>dec</sub> )
6010:06	Moving negative	Motor turns in negative direction	BOOLEAN	RO	0x00 (0 <sub>dec</sub> )
6010:07	Torque reduced	Reduced torque is active	BOOLEAN	RO	0x00 (0 <sub>dec</sub> )
6010:0C	Digital input 1	Digital input 1	BOOLEAN	RO	0x00 (0 <sub>dec</sub> )
6010:0D	Digital input 2	Digital input 2	BOOLEAN	RO	0x00 (0 <sub>dec</sub> )
6010:0E	Sync error	The Sync error bit is only required for DC mode. It indicates whether a synchronization error has occurred during the previous cycle.	BOOLEAN	RO	0x00 (0 <sub>dec</sub> )
6010:10	TxPDO Toggle	The TxPDO toggle is toggled by the slave when the data of the associated TxPDO is updated.	BOOLEAN	RO	0x00 (0 <sub>dec</sub> )
6010:11	Info data 1	Synchronous information (selection via subindex 0x8012:11 [▶ 74])	UINT16	RO	0x0000 (0 <sub>dec</sub> )
6010:12	Info data 2	Synchronous information (selection via subindex 0x8012:19 [▶ 74])	UINT16	RO	0x0000 (0 <sub>dec</sub> )
6010:14	Internal position	Internal microstep position	UINT32	RO	0x00000000 (0 <sub>dez</sub> )
6010:15	External position	Encoder position	UINT32	RO	0x00000000 (0 <sub>dez</sub> )

**Index 6020 POS Inputs Ch.1**

Index (hex)	Name	Meaning	Data type	Flags	Default
6020:0	POS Inputs Ch.1	Maximum subindex	UINT8	RO	0x22 (34 <sub>dec</sub> )
6020:01	Busy	A current travel command is active	BOOLEAN	RO	0x00 (0 <sub>dec</sub> )
6020:02	In-Target	Motor has arrived at target	BOOLEAN	RO	0x00 (0 <sub>dec</sub> )
6020:03	Warning	A warning has occurred	BOOLEAN	RO	0x00 (0 <sub>dec</sub> )
6020:04	Error	an error has occurred	BOOLEAN	RO	0x00 (0 <sub>dec</sub> )
6020:05	Calibrated	Motor is calibrated	BOOLEAN	RO	0x00 (0 <sub>dec</sub> )
6020:06	Accelerate	Motor is in the acceleration phase	BOOLEAN	RO	0x00 (0 <sub>dec</sub> )
6020:07	Decelerate	Motor is in the deceleration phase	BOOLEAN	RO	0x00 (0 <sub>dec</sub> )
6020:08	Ready to execute		BOOLEAN	RO	0x00 (0 <sub>dec</sub> )
6020:11	Actual position	Current target position of the travel command generator	UINT32	RO	0x00007FFF (32767 <sub>dec</sub> )
6020:21	Actual velocity	Current set velocity of the travel command generator	INT16	RO	0x0000 (0 <sub>dec</sub> )
6020:22	Actual drive time	Travel command time information (see subindex 0x8021:11)	UINT32	RO	0x00000000 (0 <sub>dec</sub> )
6020:23	Actual position lag		UINT32	RO	0x00000000 (0 <sub>dec</sub> )

**Index 7000 ENC Outputs Ch.1**

Index (hex)	Name	Meaning	Data type	Flags	Default
7000:0	ENC Outputs Ch.1	Maximum subindex	UINT8	RO	0x11 (17 <sub>dec</sub> )
7000:01	Enable latch C	Activate latching via the C-track.	BOOLEAN	RO	0x00 (0 <sub>dec</sub> )
7000:02	Enable latch extern on positive edge	Activate external latch with positive edge.	BOOLEAN	RO	0x00 (0 <sub>dec</sub> )
7000:03	Set counter	Set the counter value.	BOOLEAN	RO	0x00 (0 <sub>dec</sub> )
7000:04	Enable latch extern on negative edge	Activate external latch with negative edge.	BOOLEAN	RO	0x00 (0 <sub>dec</sub> )
7000:11	Set counter value	This is the counter value to be set via "Set counter".	UINT32	RO	0x00000000 (0 <sub>dec</sub> )

**Index 7010 STM Outputs Ch.1**

Index (hex)	Name	Meaning	Data type	Flags	Default
7010:0	STM Outputs Ch.1	Maximum subindex	UINT8	RO	0x21 (33 <sub>dec</sub> )
7010:01	Enable	activates the output stage (see subindex 0x8012:3A [▶ 74])	BOOLEAN	RO	0x00 (0 <sub>dec</sub> )
7010:02	Reset	all errors that may have occurred are reset by setting this bit (rising edge)	BOOLEAN	RO	0x00 (0 <sub>dec</sub> )
7010:03	Reduce torque	Activation of reduced torque (coil current) (see subindex 0x8010:02 [▶ 73])	BOOLEAN	RO	0x00 (0 <sub>dec</sub> )
7010:0C	Digital output 1	Signal at digital output 1	BOOLEAN	RO	0x00 (0 <sub>dec</sub> )
7010:11	Position	Set position	UINT32	RO	0x00000000 (0 <sub>dec</sub> )
7010:21	Velocity	Set velocity	INT16	RO	0x0000 (0 <sub>dec</sub> )

**Index 7020 POS Outputs Ch.1**

Index (hex)	Name	Meaning	Data type	Flags	Default
7020:0	POS Outputs Ch.1	Maximum subindex	UINT8	RO	0x24 (36 <sub>dec</sub> )
7020:01	Execute	Start travel command (rising edge), or prematurely abort travel command (falling edge)	BOOLEAN	RO	0x00 (0 <sub>dec</sub> )
7020:02	Emergency Stop	Prematurely abort travel command with an emergency ramp (rising edge)	BOOLEAN	RO	0x00 (0 <sub>dec</sub> )
7020:11	Target position	Specification of the target position	UINT32	RO	0x00007FFF (32767 <sub>dec</sub> )
7020:21	Velocity	Specification of the maximum set velocity	INT16	RO	0x0000 (0 <sub>dec</sub> )

Index (hex)	Name	Meaning	Data type	Flags	Default			
7020:22	Start type	Specification of the start types	0x0000	Idle	No travel command is being executed	UINT16	RO	0x0000 (0 <sub>dec</sub> )
			0x0001	Absolute	Absolute target position			
			0x0002	Relative	Target position relative to the start position			
			0x0003	Endless plus	Endless driving in positive direction of rotation			
			0x0004	Endless minus	Endless driving in negative direction of rotation			
			0x0105	Modulo short	Shortest distance to the next modulo position			
			0x0115	Modulo short extended	Shortest distance to the next modulo position (without modulo window)			
			0x0205	Modulo plus	Drive in positive direction of rotation to the next modulo position			
			0x0215	Modulo plus extended	Drive in positive direction of rotation to the next modulo position (without modulo window)			
			0x0305	Modulo minus	Drive in negative direction of rotation to the next modulo position			
			0x0315	Modulo minus extended	Drive in negative direction of rotation to the next modulo position (without modulo window)			
			0x0405	Modulo current	Drive in the last implemented direction of rotation to the next modulo position			
			0x0415	Modulo current extended	Drive in the last implemented direction of rotation to the next modulo position (without modulo window)			
			0x0006	Additive	New target position relative/additive to the last target position			
			0x6000	Calibration, Plc cam	Calibration with cam			
			0x6100	Calibration, Hw sync	Calibration with cam and C-track			
			0x6E00	Calibration, set manual	Set calibration manually			
0x6E01	Calibration, set manual auto	Set calibration automatically						

Index (hex)	Name	Meaning	Data type	Flags	Default			
			0x6F00	Calibration, clear manual	Clear calibration manually			
7020:23	Acceleration	Acceleration specification			UINT16	RO	0x0000 (0 <sub>dec</sub> )	
7020:24	Deceleration	Deceleration specification			UINT16	RO	0x0000 (0 <sub>dec</sub> )	

**Index 7021 POS Outputs 2 Ch.1 (part 1)**

Index (hex)	Name	Meaning	Data type	Flags	Default value
7021:0	POS Outputs Ch.1	Maximum subindex	UINT8	RO	0x24 (36 <sub>dec</sub> )
7021:03	Enable auto start	Enable auto start	BOOLEAN	RO	0x00 (0 <sub>dec</sub> )
7021:11	Target position	Specification of the target position	UINT32	RO	0x00000000 (0 <sub>dec</sub> )
7021:21	Velocity	Specification of the maximum set velocity	INT16	RO	0x0000 (0 <sub>dec</sub> )

**Index 7021 POS Outputs 2 Ch.1 (part 2)**

Index (hex)	Name	Meaning	Data type	Flags	Default value			
7021:22	Start type							
	0x0000 Idle: No travel command is being executed		UINT16	RO	0x0000 (0 <sub>dec</sub> )			
	0x0001 Absolute: Absolute target position		UINT16	RO	0x0000 (0 <sub>dec</sub> )			
	0x1001 Absolute (Change): Change during an active travel command		UINT16	RO	0x0000 (0 <sub>dec</sub> )			
	0x0002 Relative: Target position relative to the current position		UINT16	RO	0x0000 (0 <sub>dec</sub> )			
	0x1002 Relative (Change): Change during an active travel command		UINT16	RO	0x0000 (0 <sub>dec</sub> )			
	0x0003 Endless plus: Endless driving in positive direction of rotation		UINT16	RO	0x0000 (0 <sub>dec</sub> )			
	0x0004 Endless minus: Endless driving in negative direction of rotation		UINT16	RO	0x0000 (0 <sub>dec</sub> )			
	0x0105 Modulo short: Shortest distance to the next modulo position		UINT16	RO	0x0000 (0 <sub>dec</sub> )			
	0x0115 Modulo short extended: Shortest distance to the next modulo position (without modulo window)		UINT16	RO	0x0000 (0 <sub>dec</sub> )			
	0x0205 Modulo plus: Drive in positive direction of rotation to the next modulo position		UINT16	RO	0x0000 (0 <sub>dec</sub> )			
	0x0215 Modulo plus extended: Drive in positive direction of rotation to the next modulo position (without modulo window)		UINT16	RO	0x0000 (0 <sub>dec</sub> )			
	0x0305 Modulo minus: Drive in negative direction of rotation to the next modulo position		UINT16	RO	0x0000 (0 <sub>dec</sub> )			
	0x0315 Modulo minus extended: Drive in negative direction of rotation to the next modulo position (without modulo window)		UINT16	RO	0x0000 (0 <sub>dec</sub> )			
	0x0405 Modulo current: Drive in the last implemented direction of rotation to the next modulo position		UINT16	RO	0x0000 (0 <sub>dec</sub> )			
	0x0415 Modulo current extended: Drive in the last implemented direction of rotation to the next modulo position (without modulo window)		UINT16	RO	0x0000 (0 <sub>dec</sub> )			
	0x0006 Additive: New target position relative/additive to the last target position		UINT16	RO	0x0000 (0 <sub>dec</sub> )			
	0x1006 Additive (Change): Change during an active travel command		UINT16	RO	0x0000 (0 <sub>dec</sub> )			
0x6000 Calibration, PLC cam: Calibration with cam		UINT16	RO	0x0000 (0 <sub>dec</sub> )				
0x6100 Calibration, HW sync: Calibration with cam and C-track		UINT16	RO	0x0000 (0 <sub>dec</sub> )				
0x6E00 Calibration, set manual: Set calibration manually		UINT16	RO	0x0000 (0 <sub>dec</sub> )				
0x6E01 Calibration, set manual auto: Set automatic calibration, for "Enable = 1"		UINT16	RO	0x0000 (0 <sub>dec</sub> )				
0x6F00 Calibration, clear manual: Clear calibration manually		UINT16	RO	0x0000 (0 <sub>dec</sub> )				
7021:23	Acceleration	Acceleration specification			UINT16	RO	0x0000 (0 <sub>dec</sub> )	
7021:24	Deceleration	Deceleration specification			UINT16	RO	0x0000 (0 <sub>dec</sub> )	

**Index F081 Download revision**

Index (hex)	Name	Meaning	Data type	Flags	Default
F081:0	Download revision	Reserved	UINT8	RO	0x01 (1 <sub>dec</sub> )
F081:01	Revision number	Reserved	UINT32	RW	0x00000000 (0 <sub>dec</sub> )

## Index 9010 STM Info data Ch.1

Index (hex)	Name	Meaning	Data type	Flags	Default
9010:0	STM Info data Ch.1	Maximum subindex	UINT8	RO	0x08 (8 <sub>dec</sub> )
9010:01	Status word	Status word (see index 0xA010 [► 95])	UINT16	RO	0x0000 (0 <sub>dec</sub> )
9010:02	Motor coil voltage A	Motor voltage coil A (unit 1 mV)	UINT16	RO	0x0000 (0 <sub>dec</sub> )
9010:03	Motor coil voltage B	Motor voltage coil B (unit 1 mV)	UINT16	RO	0x0000 (0 <sub>dec</sub> )
9010:04	Motor coil current A	Motor current coil A (unit 1 mA)	INT16	RO	0x0000 (0 <sub>dec</sub> )
9010:05	Motor coil current B	Motor current coil B (unit 1 mA)	INT16	RO	0x0000 (0 <sub>dec</sub> )
9010:06	Duty cycle A	Duty cycle coil A (unit 1%)	INT8	RO	0x00 (0 <sub>dec</sub> )
9010:07	Duty cycle B	Duty cycle coil B (unit 1%)	INT8	RO	0x00 (0 <sub>dec</sub> )
9010:08	Motor velocity	Current velocity (value range +/- 10000)	INT16	RO	0x0000 (0 <sub>dec</sub> )

## Index 9020 POS Info data Ch.1

Index	Name	Meaning	Data type	Flags	Default value
9020:0	POS Info data Ch.1	Maximum subindex	UINT8	RO	0x04 (4 <sub>dec</sub> )
9020:03	State (drive controller)	permitted values: 0: Init 1: Idle 272: Go cam 273: On cam 16: Start 17: Acceleration 18: Constant 19: Deceleration 288: Go sync impulse 289: Leave cam 4096: Pre target 4097: In target 32: Emergency Stop 33: Normal stop 304: Calibration stop 8192: Drive end 8193: Wait for init 320: Is calibrated 321: Not calibrated 16384: Drive warning 32768: Error 65535: Undefined 256: Calibration start	UINT16	RO	0x0000 (0 <sub>dec</sub> )
9020:04	Actual position lag	Current step error	INT32	RO	0x00000000 (0 <sub>dec</sub> )

**Index A010 STM Diag data Ch.1**

Index (hex)	Name	Meaning	Data type	Flags	Default
A010:0	STM Diag data Ch.1	Maximum subindex	UINT8	RO	0x11 (17 <sub>dec</sub> )
A010:01	Saturated	Driver stage operates with maximum duty cycle	BOOLEAN	RO	0x00 (0 <sub>dec</sub> )
A010:02	Over temperature	Internal terminal temperature is higher than 80°C (see subindex 0xF80F:04  ▶ 96 )	BOOLEAN	RO	0x00 (0 <sub>dec</sub> )
A010:03	Torque overload	Motor current is higher than the rated current	BOOLEAN	RO	0x00 (0 <sub>dec</sub> )
A010:04	Under voltage	Motor supply voltage is 20% lower than the configured rated voltage (warning) or motor supply voltage is lower than 8 V (error, see 0xA010:09  ▶ 95 )	BOOLEAN	RO	0x00 (0 <sub>dec</sub> )
A010:05	Over voltage	Motor supply voltage is 10% higher than the configured nominal voltage	BOOLEAN	RO	0x00 (0 <sub>dec</sub> )
A010:06	Short circuit A	Short circuit in motor coil A	BOOLEAN	RO	0x00 (0 <sub>dec</sub> )
A010:07	Short circuit B	Short circuit in motor coil B	BOOLEAN	RO	0x00 (0 <sub>dec</sub> )
A010:08	No control power	Control voltage at the power contacts is less than 12 V	BOOLEAN	RO	0x00 (0 <sub>dec</sub> )
A010:09	Misc error	Initialization of the terminal failed or supply voltage is lower than 8 V or internal temperature of the terminal is higher than 100°C (see Subindex 0xF80F:05  ▶ 96 )	BOOLEAN	RO	0x00 (0 <sub>dec</sub> )
A010:11	Actual operation mode	Current operation mode (relevant for activated automatic mode, see 0x8012:01  ▶ 74 )	BIT4	RO	0x00 (0 <sub>dec</sub> )

**Index A020 POS Diag data Ch.1**

Index	Name	Meaning	Data type	Flags	Default value
A020:0	POS Diag data Ch.1	Maximum subindex	UINT8	RO	0x06 (6 <sub>dec</sub> )
A020:01	Command rejected	Travel command was rejected	BOOLEAN	RO	0x00 (0 <sub>dec</sub> )
A020:02	Command aborted	Travel command was aborted	BOOLEAN	RO	0x00 (0 <sub>dec</sub> )
A020:03	Target overrun	Target position was overrun in the opposite direction	BOOLEAN	RO	0x00 (0 <sub>dec</sub> )
A020:04	Target timeout	The target window was not reached within the in-target timeout	BOOLEAN	RO	0x00 (0 <sub>dec</sub> )
A020:05	Position lag	The maximum following error was exceeded	BOOLEAN	RO	0x00 (0 <sub>dec</sub> )
A020:06	Emergency Stop	An emergency stop was triggered (automatic or manual)	BOOLEAN	RO	0x00 (0 <sub>dec</sub> )

**Index F000 Modular device profile**

Index (hex)	Name	Meaning	Data type	Flags	Default
F000:0	Modular device profile	General information for the modular device profile	UINT8	RO	0x02 (2 <sub>dec</sub> )
F000:01	Module index distance	Index distance of the objects of the individual channels	UINT16	RO	0x0010 (16 <sub>dec</sub> )
F000:02	Maximum number of modules	Number of channels	UINT16	RO	0x0002 (2 <sub>dec</sub> )

**Index F008 Code word**

Index (hex)	Name	Meaning	Data type	Flags	Default
F008:0	Code word	reserved	UINT32	RW	0x00000000 (0 <sub>dec</sub> )

**Index F010 Module list**

Index (hex)	Name	Meaning	Data type	Flags	Default
F010:0	Module list	Maximum subindex	UINT8	RW	0x02 (2 <sub>dec</sub> )
F010:01	SubIndex 001	Profile number of the encoder interface	UINT32	RW	0x000001FF (511 <sub>dec</sub> )
F010:02	SubIndex 002	Profile number of the stepper motor interface	UINT32	RW	0x000002BF (703 <sub>dec</sub> )

**Index F80F STM Vendor data**

Index (hex)	Name	Meaning	Data type	Flags	Default
F80F:0	STM Vendor data	Maximum subindex	UINT8	RO	0x08 (8 <sub>dec</sub> )
F80F:01	PWM Frequency	DC link frequency (unit: 1 Hz)	UINT16	RW	0x7530 (30000 <sub>dec</sub> )
F80F:02	Deadtime	Dead time for pulse width modulation	UINT16	RW	0x0102 (258 <sub>dec</sub> )
F80F:03	Deadtime space	Duty cycle limitation	UINT16	RW	0x0009 (9 <sub>dec</sub> )
F80F:04	Warning temperature	Threshold for temperature warning (unit: 1°C, see subindex 0xA010:02 [► 95])	INT8	RW	0x50 (80 <sub>dec</sub> )
F80F:05	Switch off temperature	Switch-off temperature (unit: 1°C)	INT8	RW	0x64 (100 <sub>dec</sub> )
F80F:06	Analog trigger point	Trigger point for AD conversion	UINT16	RW	0x000A (10 <sub>dec</sub> )
F80F:07	Calibration offset A	Current measurement offset calibration for coil A (set by the manufacturer)	INT16	RW	0x0000 (0 <sub>dec</sub> )
F80F:08	Calibration offset B	Current measurement offset calibration for coil B (set by the manufacturer)	INT16	RW	0x0000 (0 <sub>dec</sub> )

**Index F900 STM Info data**

Index (hex)	Name	Meaning	Data type	Flags	Default
F900:0	STM Info data	Maximum subindex	UINT8	RO	0x06 (6 <sub>dec</sub> )
F900:01	Software version (driver)	Software version of the driver card	STRING	RO	{0}
F900:02	Internal temperature	Internal terminal temperature (unit: 1°C)	INT8	RO	0x00 (0 <sub>dec</sub> )
F900:04	Control voltage	Control voltage (unit: 1 mV)	UINT16	RO	0x0000 (0 <sub>dec</sub> )
F900:05	Motor supply voltage	Motor supply voltage (unit: 1 mV)	UINT16	RO	0x0000 (0 <sub>dec</sub> )
F900:06	Cycle time	Measured cycle time (unit: 1 µs)	UINT16	RO	0x0000 (0 <sub>dec</sub> )



## 7 CoE objects EP7041-3002, EP7041-3102

### 7.1 Object description and parameterization

Applies to [EP7041-3002 \[▶ 14\]](#) and [EP7041-3102 \[▶ 14\]](#)

---

#### ● Parameterization



You can parameterize the box via the "CoE - Online" tab in TwinCAT.

---

#### ● EtherCAT XML Device Description



The presentation matches that of the EtherCAT XML Device Description.

Recommendation: download the latest XML file from <https://www.beckhoff.com/> and install it according to the installation instructions.

---

#### Introduction

The CoE overview contains objects for different intended applications:

- Objects required for [parameterization during commissioning \[▶ 98\]](#)
- Objects for indicating [internal settings \[▶ 103\]](#) (may be fixed)
- Further [profile-specific objects \[▶ 115\]](#) indicating inputs, outputs and status information

The following section first describes the objects required for normal operation, followed by a complete overview of missing objects.

## 7.1.1 Objects for commissioning

### Index 1011 Restore default parameters

Index (hex)	Name	Meaning	Data type	Flags	Default
1011:0	Restore default parameters	Restore default parameters	UINT8	RO	0x01 (1 <sub>dec</sub> )
1011:01	SubIndex 001	If this object is set to "0x64616F6C" in the set value dialog, all backup objects are reset to their delivery state.	UINT32	RW	0x00000000 (0 <sub>dec</sub> )

### Index 8000 ENC Settings Ch.1

Index (hex)	Name	Meaning	Data type	Flags	Default
8000:0	ENC Settings Ch.1	Maximum subindex	UINT8	RO	0x0F (15 <sub>dec</sub> )
8000:08	Disable filter	Deactivates the input filters.	BOOLEAN	RW	0x00 (0 <sub>dec</sub> )
8000:0A	Enable micro increments	The lower 8 bits of the counter value are extrapolated.	BOOLEAN	RW	0x00 (0 <sub>dec</sub> )
8000:0E	Reversion of rotation	Activates reversion of rotation of the encoder.	BOOLEAN	RW	0x00 (0 <sub>dec</sub> )

### Index 8010 STM Motor Settings Ch.1

Index (hex)	Name	Meaning	Data type	Flags	Default
8010:0	STM Motor Settings Ch.1	Maximum subindex	UINT8	RO	0x11 (17 <sub>dec</sub> )
8010:01	Maximal current	Maximum permanent motor coil current (unit: 1 mA)	UINT16	RW	0x1388 (5000 <sub>dec</sub> )
8010:02	Reduced current	Reduced coil current (reduced torque, unit: 1 mA)	UINT16	RW	0x09C4 (2500 <sub>dec</sub> )
8010:03	Nominal voltage	Nominal voltage (supply voltage) of the motor (unit: 1 mV)	UINT16	RW	0xC350 (50000 <sub>dec</sub> )
8010:06	Motor fullsteps	Motor full steps per revolution	UINT16	RW	0x00C8 (200 <sub>dec</sub> )
8010:07	Encoder increments (4-fold)	Encoder increments per revolution (quadruple evaluation)	UINT16	RW	0x0000 (0 <sub>dec</sub> )
8010:09	Start velocity	Maximum possible start velocity of the motor	UINT16	RW	0x0000 (0 <sub>dec</sub> )
8010:10	Drive on delay time	Switch-on delay of the driver stage (unit: ms)	UINT16	RW	0x0064 (100 <sub>dec</sub> )
8010:11	Drive off delay time	Switch-off delay of the driver stage (unit: ms)	UINT16	RW	0x0096 (150 <sub>dec</sub> )

**Index 8012 STM Features Ch.1**

Index (hex)	Name	Meaning	Data type	Flags	Default	
8012:0	STM Features Ch.1	Maximum subindex	UINT8	RO	0x45 (69 <sub>dec</sub> )	
8012:01	Operation mode	Operation mode	BIT4	RW	0x00 (0 <sub>dec</sub> )	
		0				Automatic
		1				Direct velocity
		2				Velocity controller
8012:05	Speed range	Preselection of the speed range	BIT3	RW	0x01 (1 <sub>dec</sub> )	
		0				1000 full steps/second
		1				2000 full steps/second
		2				4000 full steps/second
		3				8000 full steps/second
		4				16000 full steps/second
8012:08	Feedback type	Selection of the feedback system	BIT1	RW	0x01 (1 <sub>dec</sub> )	
		0				External encoder
		1				Internal counter
8012:09	Invert motor polarity	Activates reversal of the motor rotation direction.	BOOLEAN	RW	0x00 (0 <sub>dec</sub> )	
8012:11	Select info data 1	Select "Info data 1" (see 0x6010:11)	UINT8	RW	0x00 (0 <sub>dec</sub> )	
		0				Status word
		1				reserved
		...				...
		6				reserved
		7				Current velocity (value range +/- 10000)
		8				reserved
		9				Status word 2
		10				Motor: Load
		11				Motor: "Smart Current"
		12				reserved
		...				...
		100				reserved
		101				Internal temperature of the driver card
		...				reserved
		103				Control voltage
		104				Motor supply: Voltage
		...				reserved
		106				Motor supply: Current
		107				reserved
		...				...
		149				reserved
		150				Position interface - status word
		151				Position interface - status of the internal state machine
		152				Position interface – lag error (low word)
		153				Position interface – lag error (high word)
		154				reserved
...	...					
255	reserved					

## Index 8012 STM Features Ch.1

Index (hex)	Name	Meaning	Data type	Flags	Default
8012:19	Select info data 2	Selection "Info data 2" (see 0x8012:11 [► 99])	UINT8	RW	0x09 (9 <sub>dec</sub> )
8012:30	Invert digital input 1	Inversion of digital input 1	BOOLEAN	RW	0x00 (0 <sub>dec</sub> )
8012:31	Invert digital input 2	Inversion of digital input 2	BOOLEAN	RW	0x00 (0 <sub>dec</sub> )
8012:32	Function for input 1	Selection of the function for input 1	BIT4	RW	0x00 (0 <sub>dec</sub> )
		0 Normal input			
		1 Hardware Enable			
8012:36	Function for input 2	Selection of the function for input 2	BIT4	RW	0x00 (0 <sub>dec</sub> )
		0 Normal input			
		1 Hardware Enable			
8012:3A	Function for output 1	Selection of the function for output 1	BIT4	RW	0x00 (0 <sub>dec</sub> )
		0 Normal output			
		1 Brake If the bit in 0x7010:01 is set, the output is switched with the delay time set in 0x8010:10 [► 98] and 0x8010:11 [► 98] of the driver stage.			
8012:45	Microstepping	0 Full step	BIT4	RW	0x08 (8 <sub>dec</sub> )
		1 Half step			
		2 1/4 micro-step			
		3 1/8 micro-step			
		4 1/16 micro-step			
		5 1/32 micro-step			
		6 1/64 micro-step			
		7 1/128 micro-step			
		8 1/256 micro-step			

## Index 8013 STM Controller Settings 2 Ch.1

Index (hex)	Name	Meaning	Data type	Flags	Default
8013:0	STM Controller Settings 2 Ch.1	Maximum subindex	UINT8	RO	0x07 (7 <sub>dec</sub> )
8013:01	Kp factor (velo./pos.)	Kp control factor (proportional component) for the velocity controller (unit: 0.001)	UINT16	RW	0x03E8 (1000 <sub>dec</sub> )
8013:02	Ki factor (velo./pos.)	Ki control factor (integral component) for the velocity controller (unit: 0.001)	UINT16	RW	0x0000 (0 <sub>dec</sub> )
8013:03	Inner window (velo./pos.)	Inner window for the I component of the velocity controller (unit: 1%)	UINT8	RW	0x00 (0 <sub>dec</sub> )
8013:05	Outer window (velo./pos.)	Outer window for the I component of the velocity controller (unit: 1%)	UINT8	RW	0x00 (0 <sub>dec</sub> )
8013:06	Filter cut off frequency (velo./pos.)	Filter limit frequency of the velocity controller (low-pass, unit: 1 Hz)	UINT16	RW	0x0000 (0 <sub>dec</sub> )
8013:07	Ka factor (velo./pos.)	Ka control factor of the velocity/position controller	UINT16	RW	0x0000 (0 <sub>dec</sub> )

**Index 8014 STM Motor Features Ch.1**

Index (hex)	Name	Meaning	Data type	Flags	Default
8014:0	STM Motor Features Ch.1	Maximum subindex	UINT8	RO	0x31 (49 <sub>dec</sub> )
8014:01	Chopper: Mode		BIT2	RW	0x00 (0 <sub>dec</sub> )
8014:03	Chopper: Off time		BIT4	RW	0x05 (5 <sub>dec</sub> )
8014:07	Chopper: Comparator disabled		BOOLEAN	RW	0x00 (0 <sub>dec</sub> )
8014:08	Chopper: Fast decay time		BIT4	RW	0x03 (3 <sub>dec</sub> )
8014:0C	Chopper: Sine wave offset		BIT4	RW	0x03 (3 <sub>dec</sub> )
8014:11	Chopper: Hysteresis start value		BIT3	RW	0x02 (2 <sub>dec</sub> )
8014:14	Chopper: Hysteresis end value		BIT4	RW	0x06 (6 <sub>dec</sub> )
8014:18	Chopper: Hysteresis decrement time		BIT2	RW	0x00 (0 <sub>dec</sub> )
8014:1A	Stall guard: Filter enable		BOOLEAN	RW	0x01 (1 <sub>dec</sub> )
8014:1B	Stall guard: Current up step width		BIT2	RW	0x00 (0 <sub>dec</sub> )
8014:1D	Stall guard: Current down step speed		BIT2	RW	0x00 (0 <sub>dec</sub> )
8014:1F	Stall guard: Minimum current		BIT1	RW	0x00 (0 <sub>dec</sub> )
8014:21	Stall guard: Minimum value		BIT4	RW	0x00 (0 <sub>dec</sub> )
8014:25	Stall guard: Hysteresis value		BIT4	RW	0x00 (0 <sub>dec</sub> )
8014:31	Stall guard: Threshold value		INT8	RW	0x01 (1 <sub>dec</sub> )

**Index 8020 POS Settings Ch.1**

Index (hex)	Name	Meaning	Data type	Flags	Default
8020:0	POS Settings Ch.1	Maximum subindex	UINT8	RO	0x0F (15 <sub>dec</sub> )
8020:01	Velocity min.	Minimum target velocity (range: 0 ... 10000)	INT16	RW	0x0064 (100 <sub>dec</sub> )
8020:02	Velocity max.	Maximum target velocity (range: 0 ... 10000)	INT16	RW	0x2710 (10000 <sub>dec</sub> )
8020:03	Acceleration pos.	Acceleration in positive direction of rotation (unit: 1 ms)	UINT16	RW	0x03E8 (1000 <sub>dec</sub> )
8020:04	Acceleration neg.	Acceleration in negative direction of rotation (unit: 1 ms)	UINT16	RW	0x03E8 (1000 <sub>dec</sub> )
8020:05	Deceleration pos.	Deceleration in positive direction of rotation (unit: 1 ms)	UINT16	RW	0x03E8 (1000 <sub>dec</sub> )
8020:06	Deceleration neg.	Deceleration in negative direction of rotation (unit: 1 ms)	UINT16	RW	0x03E8 (1000 <sub>dec</sub> )
8020:07	Emergency deceleration	Emergency deceleration (both directions of rotation, unit: 1 ms)	UINT16	RW	0x0064 (100 <sub>dec</sub> )
8020:08	Calibration position	Calibration position	UINT32	RW	0x00000000 (0 <sub>dec</sub> )
8020:09	Calibration velocity (towards plc cam)	Calibration velocity towards the cam (range: 0 ... 10000)	INT16	RW	0x0064 (100 <sub>dec</sub> )
8020:0A	Calibration Velocity (off plc cam)	Calibration velocity away from the cam (range: 0 ... 10000)	INT16	RW	0x000A (10 <sub>dec</sub> )
8020:0B	Target window	Target window	UINT16	RW	0x000A (10 <sub>dec</sub> )
8020:0C	In-Target timeout	Timeout at target position (unit: 1 ms)	UINT16	RW	0x03E8 (1000 <sub>dec</sub> )
8020:0D	Dead time compensation	Dead time compensation (unit: 1 µs)	INT16	RW	0x0032 (50 <sub>dec</sub> )
8020:0E	Modulo factor	Modulo factor/position	UINT32	RW	0x00000000 (0 <sub>dec</sub> )
8020:0F	Modulo tolerance window	Tolerance window for modulo positioning	UINT32	RW	0x00000000 (0 <sub>dec</sub> )

**Index 8021 POS Features Ch.1**

Index (hex)	Name	Meaning	Data type	Flags	Default	
8021:0	POS Features Ch.1	Maximum subindex	UINT8	RO	0x14 (20 <sub>dec</sub> )	
8021:01	Start type	Standard start type	UINT16	RW	0x0001 (1 <sub>dec</sub> )	
8021:11	Time information	Time information in subindex 0x6pp0:22 ("Actual drive time")	BIT2	RW	0x00 (0 <sub>dec</sub> )	
		0				Elapsed time: current drive time since start of the travel command
		...				reserved
8021:13	Invert calibration cam search direction	Inversion of the direction of rotation towards the cam	BOOLEAN	RW	0x01 (1 <sub>dec</sub> )	
8021:14	Invert sync impulse search direction	Inversion of the direction of rotation away from the cam	BOOLEAN	RW	0x00 (0 <sub>dec</sub> )	

**Index FB00 STM Command**

Index (hex)	Name	Meaning	Data type	Flags	Default	
FB00:0	STM Command	Maximum subindex	UINT8	RO	0x03 (3 <sub>dec</sub> )	
FB00:01	Request	Requesting a command	OCTET-STRING[2]	RW	{0}	
		0x8000				Software reset
FB00:02	Status	Status of the command	UINT8	RO	0x00 (0 <sub>dec</sub> )	
		0				No error, without return value
		1				No error, with return value
		2				With error, without return value
		3				With error, with return value
		...				reserved
255	Command execution active					
FB00:03	Response	Return value of the executed command (dependent on the command)	OCTET-STRING[4]	RO	{0}	

## 7.1.2 Standard objects (0x1000 .. 0x1FFF)

The standard objects have the same meaning for all EtherCAT slaves.

### Index 1000 Device type

Index (hex)	Name	Meaning	Data type	Flags	Default
1000:0	Device type	Device type of the EtherCAT slave: The Lo-Word contains the CoE profile used (5001). The Hi-Word contains the module profile according to the modular device profile.	UINT32	RO	0x00001389 (5001 <sub>dec</sub> )

### Index 1008 Device name

Index (hex)	Name	Meaning	Data type	Flags	Default
1008:0	Device name	Device name of the EtherCAT slave	STRING	RO	EP7041-3002

### Index 1009 Hardware version

Index (hex)	Name	Meaning	Data type	Flags	Default
1009:0	Hardware version	Hardware version of the EtherCAT slave	STRING	RO	00

### Index 100A Software version

Index (hex)	Name	Meaning	Data type	Flags	Default
100A:0	Software version	Firmware version of the EtherCAT slave	STRING	RO	02

### Index 1018 Identity

Index (hex)	Name	Meaning	Data type	Flags	Default
1018:0	Identity	Information for identifying the slave	UINT8	RO	0x04 (4 <sub>dec</sub> )
1018:01	Vendor ID	Vendor ID of the EtherCAT slave	UINT32	RO	0x00000002 (2 <sub>dec</sub> )
1018:02	Product code	Product code of the EtherCAT slave	UINT32	RO	0x1B814052 (461455442 <sub>dec</sub> )
1018:03	Revision	Revision number of the EtherCAT slave; the low word (bit 0-15) indicates the special terminal number, the high word (bit 16-31) refers to the device description	UINT32	RO	0x00100BBA (1051578 <sub>dec</sub> )
1018:04	Serial number	Serial number of the EtherCAT slave; the low byte (bit 0-7) of the low word contains the year of production, the high byte (bit 8-15) of the low word contains the week of production, the high word (bit 16-31) is 0	UINT32	RO	0x00000000 (0 <sub>dec</sub> )

### Index 10F0 Backup parameter handling

Index (hex)	Name	Meaning	Data type	Flags	Default
10F0:0	Backup parameter handling	Information for standardized loading and saving of backup entries	UINT8	RO	0x01 (1 <sub>dec</sub> )
10F0:01	Checksum	Checksum across all backup entries of the EtherCAT slave	UINT32	RO	0x00000000 (0 <sub>dec</sub> )

**Index 10F3 Diagnosis History**

Index (hex)	Name	Meaning	Data type	Flags	Default
10F3:0	Diagnosis History	Maximum Subindex	UINT8	RO	0x37 (55 <sub>dec</sub> )
10F3:01	Maximum Messages	Maximum number of stored messages. A maximum of 50 messages can be stored.	UINT8	RO	0x00 (0 <sub>dec</sub> )
10F3:02	Newest Message	Subindex of the latest message	UINT8	RO	0x00 (0 <sub>dec</sub> )
10F3:03	Newest Acknowledged Message	Subindex of the last confirmed message	UINT8	RW	0x00 (0 <sub>dec</sub> )
10F3:04	New Messages Available	Indicates that a new message is available	BOOLEAN	RO	0x00 (0 <sub>dec</sub> )
10F3:05	Flags	not used	UINT16	RW	0x0000 (0 <sub>dec</sub> )
10F3:06	Diagnosis Message 001	Message 1	OCTET-STRING[28]	RO	{0}
...	...	...	...	...	...
10F3:37	Diagnosis Message 050	Message 50	OCTET-STRING[28]	RO	{0}

**Index 10F8 Actual Time Stamp**

Index (hex)	Name	Meaning	Data type	Flags	Default
10F8:0	Actual Time Stamp	Time stamp	UINT64	RO	

**Index 1400 ENC RxPDO-Par Control compact**

Index (hex)	Name	Meaning	Data type	Flags	Default
1400:0	ENC RxPDO-Par Control compact	PDO Parameter RxPDO 1	UINT8	RO	0x06 (6 <sub>dec</sub> )
1400:06	Exclude RxPDOs	Specifies the RxPDOs (index of RxPDO mapping objects) that must not be transferred together with RxPDO 1	OCTET-STRING[6]	RO	01 16 00 00 00 00

**Index 1401 ENC RxPDO-Par Control**

Index (hex)	Name	Meaning	Data type	Flags	Default
1401:0	ENC RxPDO-Par Control	PDO Parameter RxPDO 2	UINT8	RO	0x06 (6 <sub>dec</sub> )
1401:06	Exclude RxPDOs	Specifies the RxPDOs (index of RxPDO mapping objects) that must not be transferred together with RxPDO 2	OCTET-STRING[6]	RO	00 16 00 00 00 00

**Index 1403 STM RxPDO-Par Position**

Index (hex)	Name	Meaning	Data type	Flags	Default
1403:0	STM RxPDO-Par Position	PDO Parameter RxPDO 4	UINT8	RO	0x06 (6 <sub>dec</sub> )
1403:06	Exclude RxPDOs	Specifies the RxPDOs (index of RxPDO mapping objects) that must not be transferred together with RxPDO 4	OCTET-STRING[6]	RO	04 16 05 16 06 16

**Index 1404 STM RxPDO-Par Velocity**

Index (hex)	Name	Meaning	Data type	Flags	Default
1404:0	STM RxPDO-Par Velocity	PDO Parameter RxPDO 5	UINT8	RO	0x06 (6 <sub>dec</sub> )
1404:06	Exclude RxPDOs	Specifies the RxPDOs (index of RxPDO mapping objects) that must not be transferred together with RxPDO 5	OCTET-STRING[6]	RO	03 16 05 16 06 16

**Index 1405 POS RxPDO-Par Control compact**

Index (hex)	Name	Meaning	Data type	Flags	Default
1405:0	POS RxPDO-Par Control compact	PDO Parameter RxPDO 6	UINT8	RO	0x06 (6 <sub>dec</sub> )
1405:06	Exclude RxPDOs	Specifies the RxPDOs (index of RxPDO mapping objects) that must not be transferred together with RxPDO 6	OCTET-STRING[6]	RO	03 16 04 16 06 16



**Index 1406 POS RxPDO-Par Control**

Index (hex)	Name	Meaning	Data type	Flags	Default
1406:0	POS RxPDO-Par Control	PDO Parameter RxPDO 7	UINT8	RO	0x06 (6 <sub>dec</sub> )
1406:06	Exclude RxPDOs	Specifies the RxPDOs (index of RxPDO mapping objects) that must not be transferred together with RxPDO 7	OCTET-STRING[6]	RO	03 16 04 16 05 16

**Index 1407 POS RxPDO-Par Control 2**

Index (hex)	Name	Meaning	Data type	Flags	Default
1407:0	POS RxPDO-Par Control	PDO Parameter RxPDO 8	UINT8	RO	0x06 (6 <sub>dec</sub> )
1407:06	Exclude RxPDOs	Specifies the RxPDOs (index of RxPDO mapping objects) that must not be transferred together with RxPDO 8	OCTET-STRING[6]	RO	03 16 04 16 05 16

**Index 1600 ENC RxPDO-Map Control compact**

Index (hex)	Name	Meaning	Data type	Flags	Default
1600:0	ENC RxPDO-Map Control compact	PDO Mapping RxPDO 1	UINT8	RO	0x07 (7 <sub>dec</sub> )
1600:01	SubIndex 001	1. PDO Mapping entry (object 0x7000 (ENC Outputs Ch.1), entry 0x01 (Enable latch C))	UINT32	RO	0x7000:01, 1
1600:02	SubIndex 002	2. PDO Mapping entry (object 0x7000 (ENC Outputs Ch.1), entry 0x02 (Enable latch extern on positive edge))	UINT32	RO	0x7000:02, 1
1600:03	SubIndex 003	3. PDO Mapping entry (object 0x7000 (ENC Outputs Ch.1), entry 0x03 (Set counter))	UINT32	RO	0x7000:03, 1
1600:04	SubIndex 004	4. PDO Mapping entry (object 0x7000 (ENC Outputs Ch.1), entry 0x04 (Enable latch extern on negative edge))	UINT32	RO	0x7000:04, 1
1600:05	SubIndex 005	5. PDO Mapping entry (4 bits align)	UINT32	RO	0x0000:00, 4
1600:06	SubIndex 006	6. PDO Mapping entry (8 bits align)	UINT32	RO	0x0000:00, 8
1600:07	SubIndex 007	7. PDO Mapping entry (object 0x7000 (ENC Outputs Ch.1), entry 0x11 (Set counter value))	UINT32	RO	0x7000:11, 16

**Index 1601 ENC RxPDO-Map Control**

Index (hex)	Name	Meaning	Data type	Flags	Default
1601:0	ENC RxPDO-Map Control	PDO Mapping RxPDO 2	UINT8	RO	0x07 (7 <sub>dec</sub> )
1601:01	SubIndex 001	1. PDO Mapping entry (object 0x7000 (ENC Outputs Ch.1), entry 0x01 (Enable latch C))	UINT32	RO	0x7000:01, 1
1601:02	SubIndex 002	2. PDO Mapping entry (object 0x7000 (ENC Outputs Ch.1), entry 0x02 (Enable latch extern on positive edge))	UINT32	RO	0x7000:02, 1
1601:03	SubIndex 003	3. PDO Mapping entry (object 0x7000 (ENC Outputs Ch.1), entry 0x03 (Set counter))	UINT32	RO	0x7000:03, 1
1601:04	SubIndex 004	4. PDO Mapping entry (object 0x7000 (ENC Outputs Ch.1), entry 0x04 (Enable latch extern on negative edge))	UINT32	RO	0x7000:04, 1
1601:05	SubIndex 005	5. PDO Mapping entry (4 bits align)	UINT32	RO	0x0000:00, 4
1601:06	SubIndex 006	6. PDO Mapping entry (8 bits align)	UINT32	RO	0x0000:00, 8
1601:07	SubIndex 007	7. PDO Mapping entry (object 0x7000 (ENC Outputs Ch.1), entry 0x11 (Set counter value))	UINT32	RO	0x7000:11, 32

**Index 1602 STM RxPDO-Map Control**

Index (hex)	Name	Meaning	Data type	Flags	Default
1602:0	STM RxPDO-Map Control	PDO Mapping RxPDO 3	UINT8	RO	0x07 (7 <sub>dec</sub> )
1602:01	SubIndex 001	1. PDO Mapping entry (object 0x7010 (STM Outputs Ch.1), entry 0x01 (Enable))	UINT32	RO	0x7010:01, 1
1602:02	SubIndex 002	2. PDO Mapping entry (object 0x7010 (STM Outputs Ch.1), entry 0x02 (Reset))	UINT32	RO	0x7010:02, 1
1602:03	SubIndex 003	3. PDO Mapping entry (object 0x7010 (STM Outputs Ch.1), entry 0x03 (Reduce torque))	UINT32	RO	0x7010:03, 1
1602:04	SubIndex 004	4. PDO Mapping entry (5 bits align)	UINT32	RO	0x0000:00, 5
1602:05	SubIndex 005	5. PDO Mapping entry (3 bits align)	UINT32	RO	0x0000:00, 3
1602:06	SubIndex 006	6. PDO Mapping entry (object 0x7010 (STM Outputs Ch.1), entry 0x0C (Digital output 1))	UINT32	RO	0x7010:0C, 1
1602:07	SubIndex 007	7. PDO Mapping entry (4 bits align)	UINT32	RO	0x0000:00, 4

**Index 1603 STM RxPDO-Map Position**

Index (hex)	Name	Meaning	Data type	Flags	Default
1603:0	STM RxPDO-Map Position	PDO Mapping RxPDO 4	UINT8	RO	0x01 (1 <sub>dec</sub> )
1603:01	SubIndex 001	1. PDO Mapping entry (object 0x7010 (STM Outputs Ch.1), entry 0x11 (Position))	UINT32	RO	0x7010:11, 32

**Index 1604 STM RxPDO-Map Velocity**

Index (hex)	Name	Meaning	Data type	Flags	Default
1604:0	STM RxPDO-Map Velocity	PDO Mapping RxPDO 5	UINT8	RO	0x01 (1 <sub>dec</sub> )
1604:01	SubIndex 001	1. PDO Mapping entry (object 0x7010 (STM Outputs Ch.1), entry 0x21 (Velocity))	UINT32	RO	0x7010:21, 16

**Index 1605 POS RxPDO-Map Control compact**

Index (hex)	Name	Meaning	Data type	Flags	Default
1605:0	POS RxPDO-Map Control compact	PDO Mapping RxPDO 6	UINT8	RO	0x05 (5 <sub>dec</sub> )
1605:01	SubIndex 001	1. PDO Mapping entry (object 0x7020 (POS Outputs Ch.1), entry 0x01 (Execute))	UINT32	RO	0x7020:01, 1
1605:02	SubIndex 002	2. PDO Mapping entry (object 0x7020 (POS Outputs Ch.1), entry 0x02 (Emergency stop))	UINT32	RO	0x7020:02, 1
1605:03	SubIndex 003	3. PDO Mapping entry (6 bits align)	UINT32	RO	0x0000:00, 6
1605:04	SubIndex 004	4. PDO Mapping entry (8 bits align)	UINT32	RO	0x0000:00, 8
1605:05	SubIndex 005	5. PDO Mapping entry (object 0x7020 (POS Outputs Ch.1), entry 0x11 (Target position))	UINT32	RO	0x7020:11, 32

**Index 1606 POS RxPDO-Map Control**

Index (hex)	Name	Meaning	Data type	Flags	Default
1606:0	POS RxPDO-Map Control	PDO Mapping RxPDO 7	UINT8	RO	0x09 (9 <sub>dec</sub> )
1606:01	SubIndex 001	1. PDO Mapping entry (object 0x7020 (POS Outputs Ch.1), entry 0x01 (Execute))	UINT32	RO	0x7020:01, 1
1606:02	SubIndex 002	2. PDO Mapping entry (object 0x7020 (POS Outputs Ch.1), entry 0x02 (Emergency stop))	UINT32	RO	0x7020:02, 1
1606:03	SubIndex 003	3. PDO Mapping entry (6 bits align)	UINT32	RO	0x0000:00, 6
1606:04	SubIndex 004	4. PDO Mapping entry (8 bits align)	UINT32	RO	0x0000:00, 8
1606:05	SubIndex 005	5. PDO Mapping entry (object 0x7020 (POS Outputs Ch.1), entry 0x11 (Target position))	UINT32	RO	0x7020:11, 32
1606:06	SubIndex 006	6. PDO Mapping entry (object 0x7020 (POS Outputs Ch.1), entry 0x21 (Velocity))	UINT32	RO	0x7020:21, 16
1606:07	SubIndex 007	7. PDO Mapping entry (object 0x7020 (POS Outputs Ch.1), entry 0x22 (Start type))	UINT32	RO	0x7020:22, 16
1606:08	SubIndex 008	8. PDO Mapping entry (object 0x7020 (POS Outputs Ch.1), entry 0x23 (Acceleration))	UINT32	RO	0x7020:23, 16
1606:09	SubIndex 009	9. PDO Mapping entry (object 0x7020 (POS Outputs Ch.1), entry 0x24 (Deceleration))	UINT32	RO	0x7020:24, 16

**Index 1607 POS RxPDO-Map Control 2**

Index (hex)	Name	Meaning	Data type	Flags	Default
1607:0	POS RxPDO-Map Control 2	PDO Mapping RxPDO 8	UINT8	RO	0x09 (9 <sub>dez</sub> )
1607:01	SubIndex 001	1. PDO Mapping entry	UINT32	RO	0x0000:00,2
1607:02	SubIndex 002	2. PDO Mapping entry (object 0x7020 (POS Outputs 2 Ch.1), entry 0x03 (Enable auto start))	UINT32	RO	0x7020:03, 1
1607:03	SubIndex 003	3. PDO Mapping entry (6 bits align)	UINT32	RO	0x0000:00,5
1607:04	SubIndex 004	4. PDO Mapping entry (8 bits align)	UINT32	RO	0x0000:00, 8
1607:05	SubIndex 005	5. PDO Mapping entry (object 0x7021 (POS Outputs 2 Ch.1), entry 0x11 (Target position))	UINT32	RO	0x7021:11, 32
1607:06	SubIndex 006	6. PDO Mapping entry (object 0x7021 (POS Outputs 2 Ch.1), entry 0x21 (Velocity))	UINT32	RO	0x7021:21, 16
1607:07	SubIndex 007	7. PDO Mapping entry (object 0x7021 (POS Outputs 2 Ch.1), entry 0x22 (Start type))	UINT32	RO	0x7021:22, 16
1607:08	SubIndex 008	8. PDO Mapping entry (object 0x7021 (POS Outputs 2 Ch.1), entry 0x23 (Acceleration))	UINT32	RO	0x7021:23, 16
1607:09	SubIndex 009	9. PDO Mapping entry (object 0x7021 (POS Outputs 2 Ch.1), entry 0x24 (Deceleration))	UINT32	RO	0x7021:24, 16

**Index 1800 ENC TxPDO-Par Status compact**

Index (hex)	Name	Meaning	Data type	Flags	Default
1800:0	ENC TxPDO-Par Status compact	PDO Parameter TxPDO 1	UINT8	RO	0x06 (6 <sub>dec</sub> )
1800:06	Exclude TxPDOs	Specifies the TxPDOs (index of TxPDO mapping objects) that must not be transferred together with TxPDO 1	OCTET-STRING[2]	RO	01 1A

**Index 1801 ENC TxPDO-Par Status**

Index (hex)	Name	Meaning	Data type	Flags	Default
1801:0	ENC TxPDO-Par Status	PDO Parameter TxPDO 2	UINT8	RO	0x06 (6 <sub>dec</sub> )
1801:06	Exclude TxPDOs	Specifies the TxPDOs (index of TxPDO mapping objects) that must not be transferred together with TxPDO 2	OCTET-STRING[2]	RO	00 1A

**Index 1806 POS TxPDO-Par Status compact**

Index (hex)	Name	Meaning	Data type	Flags	Default
1806:0	POS TxPDO-Par Status compact	PDO parameter TxPDO 7	UINT8	RO	0x06 (6 <sub>dec</sub> )
1806:06	Exclude TxPDOs	Specifies the TxPDOs (index of TxPDO mapping objects) that must not be transferred together with TxPDO 7	OCTET-STRING[2]	RO	07 1A

**Index 1807 POS TxPDO-Par Status**

Index (hex)	Name	Meaning	Data type	Flags	Default
1807:0	POS TxPDO-Par Status	PDO parameter TxPDO 8	UINT8	RO	0x06 (6 <sub>dec</sub> )
1807:06	Exclude TxPDOs	Specifies the TxPDOs (index of TxPDO mapping objects) that must not be transferred together with TxPDO 8	OCTET-STRING[2]	RO	06 1A

**Index 1A00 ENC TxPDO-Map Status compact**

Index (hex)	Name	Meaning	Data type	Flags	Default
1A00:0	ENC TxPDO-Map Status compact	PDO Mapping TxPDO 1	UINT8	RO	0x11 (17 <sub>dec</sub> )
1A00:01	SubIndex 001	1. PDO Mapping entry (object 0x6000 (ENC Inputs Ch.1), entry 0x01 (Latch C valid))	UINT32	RO	0x6000:01, 1
1A00:02	SubIndex 002	2. PDO Mapping entry (object 0x6000 (ENC Inputs Ch.1), entry 0x02 (Latch extern valid))	UINT32	RO	0x6000:02, 1
1A00:03	SubIndex 003	3. PDO Mapping entry (object 0x6000 (ENC Inputs Ch.1), entry 0x03 (Set counter done))	UINT32	RO	0x6000:03, 1
1A00:04	SubIndex 004	4. PDO Mapping entry (object 0x6000 (ENC Inputs Ch.1), entry 0x04 (Counter underflow))	UINT32	RO	0x6000:04, 1
1A00:05	SubIndex 005	5. PDO Mapping entry (object 0x6000 (ENC Inputs Ch.1), entry 0x05 (Counter overflow))	UINT32	RO	0x6000:05, 1
1A00:06	SubIndex 006	6. PDO Mapping entry (2 bits align)	UINT32	RO	0x0000:00, 2
1A00:07	SubIndex 007	7. PDO Mapping entry (object 0x6000 (ENC Inputs Ch.1), entry 0x08 (Extrapolation stall))	UINT32	RO	0x6000:08, 1
1A00:08	SubIndex 008	8. PDO Mapping entry (object 0x6000 (ENC Inputs Ch.1), entry 0x09 (Status of input A))	UINT32	RO	0x6000:09, 1
1A00:09	SubIndex 009	9. PDO Mapping entry (object 0x6000 (ENC Inputs Ch.1), entry 0x0A (Status of input B))	UINT32	RO	0x6000:0A, 1
1A00:0A	SubIndex 010	10. PDO Mapping entry (object 0x6000 (ENC Inputs Ch.1), entry 0x0B (Status of input C))	UINT32	RO	0x6000:0B, 1
1A00:0B	SubIndex 011	11. PDO Mapping entry (1 bits align)	UINT32	RO	0x0000:00, 1
1A00:0C	SubIndex 012	12. PDO Mapping entry (object 0x6000 (ENC Inputs Ch.1), entry 0x0D (Status of extern latch))	UINT32	RO	0x6000:0D, 1
1A00:0D	SubIndex 013	13. PDO Mapping entry (object 0x1C32 (SM output parameter), entry 0x20 (Sync error))	UINT32	RO	0x1C32:20, 1
1A00:0E	SubIndex 014	14. PDO Mapping entry (1 bits align)	UINT32	RO	0x0000:00, 1
1A00:0F	SubIndex 015	15. PDO Mapping entry (object 0x1800 (ENC TxPDO-Par Status compact), entry 0x09)	UINT32	RO	0x1800:09, 1
1A00:10	SubIndex 016	16. PDO Mapping entry (object 0x6000 (ENC Inputs Ch.1), entry 0x11 (Counter value))	UINT32	RO	0x6000:11, 16
1A00:11	SubIndex 017	17. PDO Mapping entry (object 0x6000 (ENC Inputs Ch.1), entry 0x12 (Latch value))	UINT32	RO	0x6000:12, 16

**Index 1A01 ENC TxPDO-Map Status**

Index (hex)	Name	Meaning	Data type	Flags	Default
1A01:0	ENC TxPDO-Map Status	PDO Mapping TxPDO 2	UINT8	RO	0x11 (17 <sub>dec</sub> )
1A01:01	SubIndex 001	1. PDO Mapping entry (object 0x6000 (ENC Inputs Ch.1), entry 0x01 (Latch C valid))	UINT32	RO	0x6000:01, 1
1A01:02	SubIndex 002	2. PDO Mapping entry (object 0x6000 (ENC Inputs Ch.1), entry 0x02 (Latch extern valid))	UINT32	RO	0x6000:02, 1
1A01:03	SubIndex 003	3. PDO Mapping entry (object 0x6000 (ENC Inputs Ch.1), entry 0x03 (Set counter done))	UINT32	RO	0x6000:03, 1
1A01:04	SubIndex 004	4. PDO Mapping entry (object 0x6000 (ENC Inputs Ch.1), entry 0x04 (Counter underflow))	UINT32	RO	0x6000:04, 1
1A01:05	SubIndex 005	5. PDO Mapping entry (object 0x6000 (ENC Inputs Ch.1), entry 0x05 (Counter overflow))	UINT32	RO	0x6000:05, 1
1A01:06	SubIndex 006	6. PDO Mapping entry (2 bits align)	UINT32	RO	0x0000:00, 2
1A01:07	SubIndex 007	7. PDO Mapping entry (object 0x6000 (ENC Inputs Ch.1), entry 0x08 (Extrapolation stall))	UINT32	RO	0x6000:08, 1
1A01:08	SubIndex 008	8. PDO Mapping entry (object 0x6000 (ENC Inputs Ch.1), entry 0x09 (Status of input A))	UINT32	RO	0x6000:09, 1
1A01:09	SubIndex 009	9. PDO Mapping entry (object 0x6000 (ENC Inputs Ch.1), entry 0x0A (Status of input B))	UINT32	RO	0x6000:0A, 1
1A01:0A	SubIndex 010	10. PDO Mapping entry (object 0x6000 (ENC Inputs Ch.1), entry 0x0B (Status of input C))	UINT32	RO	0x6000:0B, 1
1A01:0B	SubIndex 011	11. PDO Mapping entry (1 bits align)	UINT32	RO	0x0000:00, 1
1A01:0C	SubIndex 012	12. PDO Mapping entry (object 0x6000 (ENC Inputs Ch.1), entry 0x0D (Status of extern latch))	UINT32	RO	0x6000:0D, 1
1A01:0D	SubIndex 013	13. PDO Mapping entry (object 0x1C32 (SM output parameter), entry 0x20 (Sync error))	UINT32	RO	0x1C32:20, 1
1A01:0E	SubIndex 014	14. PDO Mapping entry (1 bits align)	UINT32	RO	0x0000:00, 1
1A01:0F	SubIndex 015	15. PDO Mapping entry (object 0x1801 (ENC TxPDO-Par Status), entry 0x09)	UINT32	RO	0x1801:09, 1
1A01:10	SubIndex 016	16. PDO Mapping entry (object 0x6000 (ENC Inputs Ch.1), entry 0x11 (Counter value))	UINT32	RO	0x6000:11, 32
1A01:11	SubIndex 017	17. PDO Mapping entry (object 0x6000 (ENC Inputs Ch.1), entry 0x12 (Latch value))	UINT32	RO	0x6000:12, 32

**Index 1A02 ENC TxPDO-Map Timest. compact**

Index (hex)	Name	Meaning	Data type	Flags	Default
1A02:0	ENC TxPDO-Map Timest. compact	PDO Mapping TxPDO 3	UINT8	RO	0x01 (1 <sub>dec</sub> )
1A02:01	SubIndex 001	1. PDO Mapping entry (object 0x6000 (ENC Inputs Ch.1), entry 0x16 (Timestamp))	UINT32	RO	0x6000:16, 32

**Index 1A03 STM TxPDO-Map Status**

Index (hex)	Name	Meaning	Data type	Flags	Default
1A03:0	STM TxPDO-Map Status	PDO Mapping TxPDO 4	UINT8	RO	0x0E (14 <sub>dec</sub> )
1A03:01	SubIndex 001	1. PDO Mapping entry (object 0x6010 (STM Inputs Ch.1), entry 0x01 (Ready to enable))	UINT32	RO	0x6010:01, 1
1A03:02	SubIndex 002	2. PDO Mapping entry (object 0x6010 (STM Inputs Ch.1), entry 0x02 (Ready))	UINT32	RO	0x6010:02, 1
1A03:03	SubIndex 003	3. PDO Mapping entry (object 0x6010 (STM Inputs Ch.1), entry 0x03 (Warning))	UINT32	RO	0x6010:03, 1
1A03:04	SubIndex 004	4. PDO Mapping entry (object 0x6010 (STM Inputs Ch.1), entry 0x04 (Error))	UINT32	RO	0x6010:04, 1
1A03:05	SubIndex 005	5. PDO Mapping entry (object 0x6010 (STM Inputs Ch.1), entry 0x05 (Moving positive))	UINT32	RO	0x6010:05, 1
1A03:06	SubIndex 006	6. PDO Mapping entry (object 0x6010 (STM Inputs Ch.1), entry 0x06 (Moving negative))	UINT32	RO	0x6010:06, 1
1A03:07	SubIndex 007	7. PDO Mapping entry (object 0x6010 (STM Inputs Ch.1), entry 0x07 (Torque reduced))	UINT32	RO	0x6010:07, 1
1A03:08	SubIndex 008	8. PDO Mapping entry (1 bits align)	UINT32	RO	0x6010:08, 1
1A03:09	SubIndex 009	9. PDO Mapping entry (3 bits align)	UINT32	RO	0x0000:00, 3
1A03:0A	SubIndex 010	10. PDO Mapping entry (object 0x6010 (STM Inputs Ch.1), entry 0x0C (Digital input 1))	UINT32	RO	0x6010:0C, 1
1A03:0B	SubIndex 011	11. PDO Mapping entry (object 0x6010 (STM Inputs Ch.1), entry 0x0D (Digital input 2))	UINT32	RO	0x6010:0D, 1
1A03:0C	SubIndex 012	12. PDO Mapping entry (object 0x1C32 (SM output parameter), entry 0x20 (Sync error))	UINT32	RO	0x6010:0E, 1
1A03:0D	SubIndex 013	13. PDO Mapping entry (1 bits align)	UINT32	RO	0x0000:00, 1
1A03:0E	SubIndex 014	14. PDO Mapping entry (object 0x1803, entry 0x09)	UINT32	RO	0x6010:10, 1

**Index 1A04 STM TxPDO-Map Synchron info data**

Index (hex)	Name	Meaning	Data type	Flags	Default
1A04:0	STM TxPDO-Map Synchron info data	PDO Mapping TxPDO 5	UINT8	RO	0x02 (2 <sub>dec</sub> )
1A04:01	SubIndex 001	1. PDO Mapping entry (object 0x6010 (STM Inputs Ch.1), entry 0x11 (Info data 1))	UINT32	RO	0x6010:11, 16
1A04:02	SubIndex 002	2. PDO Mapping entry (object 0x6010 (STM Inputs Ch.1), entry 0x12 (Info data 2))	UINT32	RO	0x6010:12, 16

**Index 1A05 STM TxPDO-Map Motor load**

Index (hex)	Name	Meaning	Data type	Flags	Default
1A05:0	STM TxPDO-Map Motor load	PDO Mapping TxPDO 6	UINT8	RO	0x01 (1 <sub>dec</sub> )
1A05:01	SubIndex 001	1. PDO Mapping entry (object 0x6020 (POS Inputs Ch.1), entry 0x01 (Busy))	UINT32	RO	0x6010:13, 16

**Index 1A06 POS TxPDO-Map Status compact**

Index (hex)	Name	Meaning	Data type	Flags	Default
1A06:0	POS TxPDO-Map Status compact	PDO Mapping TxPDO 7	UINT8	RO	0x09 (9 <sub>dec</sub> )
1A06:01	SubIndex 001	1. PDO Mapping entry (object 0x6020 (POS Inputs Ch.1), entry 0x01 (Busy))	UINT32	RO	0x6020:01, 1
1A06:02	SubIndex 002	2. PDO Mapping entry (object 0x6020 (POS Inputs Ch.1), entry 0x02 (In-Target))	UINT32	RO	0x6020:02, 1
1A06:03	SubIndex 003	3. PDO Mapping entry (object 0x6020 (POS Inputs Ch.1), entry 0x03 (Warning))	UINT32	RO	0x6020:03, 1
1A06:04	SubIndex 004	4. PDO Mapping entry (object 0x6020 (POS Inputs Ch.1), entry 0x04 (Error))	UINT32	RO	0x6020:04, 1
1A06:05	SubIndex 005	5. PDO Mapping entry (object 0x6020 (POS Inputs Ch.1), entry 0x05 (Calibrated))	UINT32	RO	0x6020:05, 1
1A06:06	SubIndex 006	6. PDO Mapping entry (object 0x6020 (POS Inputs Ch.1), entry 0x06 (Accelerate))	UINT32	RO	0x6020:06, 1
1A06:07	SubIndex 007	7. PDO Mapping entry (object 0x6020 (POS Inputs Ch.1), entry 0x07 (Decelerate))	UINT32	RO	0x6020:07, 1
1A06:08	SubIndex 008	8. PDO Mapping entry (object 0x6020 (POS Inputs Ch.1), entry 0x08 (Ready to execute))	UINT32	RO	0x6020:08, 1
1A06:09	SubIndex 009	9. PDO Mapping entry (8 bits align)	UINT32	RO	0x0000:00, 8

**Index 1A07 POS TxPDO-Map Status**

Index (hex)	Name	Meaning	Data type	Flags	Default
1A07:0	POS TxPDO-Map Status	PDO Mapping TxPDO 8	UINT8	RO	0x0C (12 <sub>dec</sub> )
1A07:01	SubIndex 001	1. PDO Mapping entry (object 0x6020 (POS Inputs Ch.1), entry 0x01 (Busy))	UINT32	RO	0x6020:01, 1
1A07:02	SubIndex 002	2. PDO Mapping entry (object 0x6020 (POS Inputs Ch.1), entry 0x02 (In-Target))	UINT32	RO	0x6020:02, 1
1A07:03	SubIndex 003	3. PDO Mapping entry (object 0x6020 (POS Inputs Ch.1), entry 0x03 (Warning))	UINT32	RO	0x6020:03, 1
1A07:04	SubIndex 004	4. PDO Mapping entry (object 0x6020 (POS Inputs Ch.1), entry 0x04 (Error))	UINT32	RO	0x6020:04, 1
1A07:05	SubIndex 005	5. PDO Mapping entry (object 0x6020 (POS Inputs Ch.1), entry 0x05 (Calibrated))	UINT32	RO	0x6020:05, 1
1A07:06	SubIndex 006	6. PDO Mapping entry (object 0x6020 (POS Inputs Ch.1), entry 0x06 (Accelerate))	UINT32	RO	0x6020:06, 1
1A07:07	SubIndex 007	7. PDO Mapping entry (object 0x6020 (POS Inputs Ch.1), entry 0x07 (Decelerate))	UINT32	RO	0x6020:07, 1
1A07:08	SubIndex 008	8. PDO Mapping entry (1 bits align)	UINT32	RO	0x0000:00, 1
1A07:09	SubIndex 009	9. PDO Mapping entry (8 bits align)	UINT32	RO	0x0000:00, 8
1A07:0A	SubIndex 010	10. PDO Mapping entry (object 0x6020 (POS Inputs Ch.1), entry 0x11 (Actual position))	UINT32	RO	0x6020:11, 32
1A07:0B	SubIndex 011	11. PDO Mapping entry (object 0x6020 (POS Inputs Ch.1), entry 0x21 (Actual velocity))	UINT32	RO	0x6020:21, 16
1A07:0C	SubIndex 012	12. PDO Mapping entry (object 0x6020 (POS Inputs Ch.1), entry 0x22 (Actual drive time))	UINT32	RO	0x6020:22, 32

**Index 1A08 STM TxPDO-Map Internal Position**

Index (hex)	Name	Meaning	Data type	Flags	Default
1A08:0	STM TxPDO-Map Internal Position	PDO Mapping TxPDO 9	UINT8	RO	0x01 (1 <sub>dec</sub> )
1A08:01	SubIndex 001	1. PDO Mapping entry (object 0x6010 (STM Inputs Ch.1), entry 0x14 (Internal Position))	UINT32	RO	0x6010:14, 32

**Index 1A09 STM TxPDO-Map External Position**

Index (hex)	Name	Bedeutung	Datentyp	Flags	Default
1A09:0	STM TxPDO-Map External Position	PDO Mapping TxPDO 10	UINT8	RO	0x01 (1 <sub>dec</sub> )
1A09:01	SubIndex 001	1. PDO Mapping entry (object 0x6010 (STM Inputs Ch.1), entry 0x15 (External Position))	UINT32	RO	0x6010:15, 32



**Index 1A0A POS TxPDO-Map Actual Position lag**

Index (hex)	Name	Bedeutung	Datentyp	Flags	Default
1A0A:0	POS TxPDO-Map Actual Position lag	PDO Mapping TxPDO 11	UINT8	RO	0x01 (1 <sub>dez</sub> )
1A0A:01	SubIndex 001	1. PDO Mapping entry (object 0x6010 (POS Inputs Ch. 1), entry 0x23 (Actual position lag))	UINT32	RO	0x6020:23, 32

**Index 1C00 Sync manager type**

Index (hex)	Name	Meaning	Data type	Flags	Default
1C00:0	Sync manager type	Benutzung der Sync Manager	UINT8	RO	0x04 (4 <sub>dez</sub> )
1C00:01	SubIndex 001	Sync-Manager Type Channel 1: Mailbox Write	UINT8	RO	0x01 (1 <sub>dez</sub> )
1C00:02	SubIndex 002	Sync-Manager Type Channel 2: Mailbox Read	UINT8	RO	0x02 (2 <sub>dez</sub> )
1C00:03	SubIndex 003	Sync-Manager Type Channel 3: Process Data Write (Outputs)	UINT8	RO	0x03 (3 <sub>dez</sub> )
1C00:04	SubIndex 004	Sync-Manager Type Channel 4: Process Data Read (Inputs)	UINT8	RO	0x04 (4 <sub>dez</sub> )

**Index 1C12 RxPDO assign**

Index (hex)	Name	Meaning	Data type	Flags	Default
1C12:0	RxPDO assign	PDO Assign Outputs	UINT8	RW	0x03 (3 <sub>dez</sub> )
1C12:01	Subindex 001	1. allocated RxPDO (contains the index of the associated RxPDO mapping object)	UINT16	RW	0x1600 (5632 <sub>dez</sub> )
1C12:02	Subindex 002	2. allocated RxPDO (contains the index of the associated RxPDO mapping object)	UINT16	RW	0x1602 (5634 <sub>dez</sub> )
1C12:03	Subindex 003	3. allocated RxPDO (contains the index of the associated RxPDO mapping object)	UINT16	RW	0x1604 (5636 <sub>dez</sub> )

**Index 1C13 TxPDO assign**

Index (hex)	Name	Meaning	Data type	Flags	Default
1C13:0	TxPDO assign	PDO Assign Inputs	UINT8	RW	0x02 (2 <sub>dez</sub> )
1C13:01	Subindex 001	1. allocated TxPDO (contains the index of the associated TxPDO mapping object)	UINT16	RW	0x1A00 (6656 <sub>dez</sub> )
1C13:02	Subindex 002	2. allocated TxPDO (contains the index of the associated TxPDO mapping object)	UINT16	RW	0x1A03 (6659 <sub>dez</sub> )
1C13:03	Subindex 003	3. allocated TxPDO (contains the index of the associated TxPDO mapping object)	UINT16	RW	0x0000 (0 <sub>dez</sub> )
1C13:04	Subindex 004	4. allocated TxPDO (contains the index of the associated TxPDO mapping object)	UINT16	RW	0x0000 (0 <sub>dez</sub> )
1C13:05	Subindex 005	5. allocated TxPDO (contains the index of the associated TxPDO mapping object)	UINT16	RW	0x0000 (0 <sub>dez</sub> )
1C13:06	Subindex 006	6. allocated TxPDO (contains the index of the associated TxPDO mapping object)	UINT16	RW	0x0000 (0 <sub>dez</sub> )
1C13:07	Subindex 007	7. allocated TxPDO (contains the index of the associated TxPDO mapping object)	UINT16	RW	0x0000 (0 <sub>dez</sub> )
1C13:08	Subindex 008	8. allocated TxPDO (contains the index of the associated TxPDO mapping object)	UINT16	RW	0x0000 (0 <sub>dez</sub> )
1C13:09	Subindex 009	9. allocated TxPDO (contains the index of the associated TxPDO mapping object)	UINT16	RW	0x0000 (0 <sub>dez</sub> )



**Index 1C32 SM output parameter**

Index (hex)	Name	Meaning	Data type	Flags	Default
1C32:0	SM output parameter	Synchronization parameters for the outputs	UINT8	RO	0x20 (32 <sub>dec</sub> )
1C32:01	Sync mode	Current synchronization mode: <ul style="list-style-type: none"> <li>• 0: Free Run</li> <li>• 1: Synchron with SM 2 Event</li> <li>• 2: DC-Mode - Synchron with SYNC0 Event</li> <li>• 3: DC-Mode - Synchron with SYNC1 Event</li> </ul>	UINT16	RW	0x0001 (1 <sub>dec</sub> )
1C32:02	Cycle time	Cycle time (in ns): <ul style="list-style-type: none"> <li>• Free Run: Cycle time of the local timer</li> <li>• Synchron with SM 2 Event: Master cycle time</li> <li>• DC-Mode: SYNC0/SYNC1 Cycle Time</li> </ul>	UINT32	RW	0x000F4240 (1000000 <sub>dec</sub> )
1C32:03	Shift time	Time between SYNC0 event and output of the outputs (in ns, DC mode only)	UINT32	RO	0x00000000 (0 <sub>dec</sub> )
1C32:04	Sync modes supported	Supported synchronization modes: <ul style="list-style-type: none"> <li>• Bit 0 = 1: free run is supported</li> <li>• Bit 1 = 1: Synchronous with SM 2 event is supported</li> <li>• Bit 2-3 = 01: DC mode is supported</li> <li>• Bit 4-5 = 10: Output shift with SYNC1 event (only DC mode)</li> <li>• Bit 14 = 1: dynamic times (measurement through writing of 0x1C32:08 [▶ 113])</li> </ul>	UINT16	RO	0xC007 (49159 <sub>dec</sub> )
1C32:05	Minimum cycle time	Minimum cycle time (in ns)	UINT32	RO	0x0003D090 (250000 <sub>dec</sub> )
1C32:06	Calc and copy time	Minimum time between SYNC0 and SYNC1 event (in ns, DC mode only)	UINT32	RO	0x00000000 (0 <sub>dec</sub> )
1C32:07	Minimum delay time		UINT32	RO	0x00000000 (0 <sub>dec</sub> )
1C32:08	Command	<ul style="list-style-type: none"> <li>• 0: Measurement of the local cycle time is stopped</li> <li>• 1: Measurement of the local cycle time is started</li> </ul> <p>The entries 0x1C32:03 [▶ 113], 0x1C32:05 [▶ 113], 0x1C32:06 [▶ 113], 0x1C32:09 [▶ 113], 0x1C33:03 [▶ 114], 0x1C33:06 [▶ 113], 0x1C33:09 [▶ 114] are updated with the maximum measured values. For a subsequent measurement the measured values are reset</p>	UINT16	RW	0x0000 (0 <sub>dec</sub> )
1C32:09	Maximum delay time	Time between SYNC1 event and output of the outputs (in ns, DC mode only)	UINT32	RO	0x00000000 (0 <sub>dec</sub> )
1C32:0B	SM event missed counter	Number of missed SM events in OPERATIONAL (DC mode only)	UINT16	RO	0x0000 (0 <sub>dec</sub> )
1C32:0C	Cycle exceeded counter	Number of occasions the cycle time was exceeded in OPERATIONAL (cycle was not completed in time or the next cycle began too early)	UINT16	RO	0x0000 (0 <sub>dec</sub> )
1C32:0D	Shift too short counter	Number of occasions that the interval between SYNC0 and SYNC1 event was too short (DC mode only)	UINT16	RO	0x0000 (0 <sub>dec</sub> )
1C32:20	Sync error	The synchronization was not correct in the last cycle (outputs were output too late; DC mode only)	BOOLEAN	RO	0x00 (0 <sub>dec</sub> )

## Index 1C33 SM input parameter

Index (hex)	Name	Meaning	Data type	Flags	Default
1C33:0	SM input parameter	Synchronization parameters for the inputs	UINT8	RO	0x20 (32 <sub>dec</sub> )
1C33:01	Sync mode	Current synchronization mode: <ul style="list-style-type: none"> <li>• 0: Free Run</li> <li>• 1: Synchronous with SM 3 Event (no outputs available)</li> <li>• 2: DC - Synchron with SYNC0 Event</li> <li>• 3: DC - Synchron with SYNC1 Event</li> <li>• 34: Synchronous with SM 2 Event (outputs available)</li> </ul>	UINT16	RW	0x0022 (34 <sub>dec</sub> )
1C33:02	Cycle time	as <a href="#">0x1C32:02 [► 113]</a>	UINT32	RW	0x000F4240 (1000000 <sub>dec</sub> )
1C33:03	Shift time	Time between SYNC0 event and reading of the inputs (in ns, only DC mode)	UINT32	RO	0x00000000 (0 <sub>dec</sub> )
1C33:04	Sync modes supported	Supported synchronization modes: <ul style="list-style-type: none"> <li>• Bit 0: free run is supported</li> <li>• Bit 1: Synchronous with SM 2 Event is supported (outputs available)</li> <li>• Bit 1: Synchronous with SM 3 Event is supported (no outputs available)</li> <li>• Bit 2-3 = 01: DC mode is supported</li> <li>• Bit 4-5 = 01: Input shift through local event (outputs available)</li> <li>• Bit 4-5 = 10: Input shift with SYNC1 event (no outputs available)</li> <li>• Bit 14 = 1: dynamic times (measurement through writing of <a href="#">0x1C32:08 [► 113]</a> or <a href="#">0x1C33:08 [► 114]</a>)</li> </ul>	UINT16	RO	0xC007 (49159 <sub>dec</sub> )
1C33:05	Minimum cycle time	as <a href="#">0x1C32:05 [► 113]</a>	UINT32	RO	0x0003D090 (250000 <sub>dec</sub> )
1C33:06	Calc and copy time	Time between reading of the inputs and availability of the inputs for the master (in ns, only DC mode)	UINT32	RO	0x00000000 (0 <sub>dec</sub> )
1C33:07	Minimum delay time		UINT32	RO	0x00000000 (0 <sub>dec</sub> )
1C33:08	Command	as <a href="#">0x1C32:08 [► 113]</a>	UINT16	RW	0x0000 (0 <sub>dec</sub> )
1C33:09	Maximum delay time	Time between SYNC1 event and reading of the inputs (in ns, only DC mode)	UINT32	RO	0x00000000 (0 <sub>dec</sub> )
1C33:0B	SM event missed counter	as <a href="#">0x1C32:11 [► 113]</a>	UINT16	RO	0x0000 (0 <sub>dec</sub> )
1C33:0C	Cycle exceeded counter	as <a href="#">0x1C32:12 [► 113]</a>	UINT16	RO	0x0000 (0 <sub>dec</sub> )
1C33:0D	Shift too short counter	as <a href="#">0x1C32:13 [► 113]</a>	UINT16	RO	0x0000 (0 <sub>dec</sub> )
1C33:20	Sync error	as <a href="#">0x1C32:32 [► 113]</a>	BOOLEAN	RO	0x00 (0 <sub>dec</sub> )

### 7.1.3 Profile-specific objects (0x6000 .. 0xFFFF)

The profile-specific objects have the same meaning for all EtherCAT slaves that support the profile 5001.

#### Index 6000 ENC Inputs Ch.1

Index (hex)	Name	Meaning	Data type	Flags	Default
6000:0	ENC Inputs Ch.1	Maximum subindex	UINT8	RO	0x16 (22 <sub>dec</sub> )
6000:01	Latch C valid	The counter value was latched with the C track.	BOOLEAN	RO	0x00 (0 <sub>dec</sub> )
6000:02	Latch extern valid	The counter value was stored via the external latch.	BOOLEAN	RO	0x00 (0 <sub>dec</sub> )
6000:03	Set counter done	The counter was set.	BOOLEAN	RO	0x00 (0 <sub>dec</sub> )
6000:04	Counter underflow	Counter underflow.	BOOLEAN	RO	0x00 (0 <sub>dec</sub> )
6000:05	Counter overflow	Counter overflow.	BOOLEAN	RO	0x00 (0 <sub>dec</sub> )
6000:08	Extrapolation stall	The extrapolated part of the counter is invalid	BOOLEAN	RO	0x00 (0 <sub>dec</sub> )
6000:09	Status of input A	Status of the A-input.	BOOLEAN	RO	0x00 (0 <sub>dec</sub> )
6000:0A	Status of input B	Status of the B-input.	BOOLEAN	RO	0x00 (0 <sub>dec</sub> )
6000:0B	Status of input C	Status of the C-input.	BOOLEAN	RO	0x00 (0 <sub>dec</sub> )
6000:0D	Status of extern latch	Status of the ext. latch input.	BOOLEAN	RO	0x00 (0 <sub>dec</sub> )
6000:0E	Sync error	The Sync error bit is only required for DC mode. It indicates whether a synchronization error has occurred during the previous cycle.	BOOLEAN	RO	0x00 (0 <sub>dec</sub> )
6000:10	TxPDO Toggle	The TxPDO toggle is toggled by the slave when the data of the associated TxPDO is updated.	BOOLEAN	RO	0x00 (0 <sub>dec</sub> )
6000:11	Counter value	The counter value.	UINT32	RO	0x00000000 (0 <sub>dec</sub> )
6000:12	Latch value	The latch value.	UINT32	RO	0x00000000 (0 <sub>dec</sub> )
6000:16	Timestamp	Time stamp of the last counter change.	UINT32	RO	0x00000000 (0 <sub>dec</sub> )

#### Index 6010 STM Inputs Ch.1

Index (hex)	Name	Meaning	Data type	Flags	Default
6010:0	STM Inputs Ch.1	Maximum subindex	UINT8	RO	0x12 (18 <sub>dec</sub> )
6010:01	Ready to enable	Driver stage is ready for enabling	BOOLEAN	RO	0x00 (0 <sub>dec</sub> )
6010:02	Ready	Driver stage is ready for operation	BOOLEAN	RO	0x00 (0 <sub>dec</sub> )
6010:03	Warning	A warning has occurred	BOOLEAN	RO	0x00 (0 <sub>dec</sub> )
6010:04	Error	An error has occurred (see index 0xA010 [▶ 119])	BOOLEAN	RO	0x00 (0 <sub>dec</sub> )
6010:05	Moving positive	Motor turns in positive direction	BOOLEAN	RO	0x00 (0 <sub>dec</sub> )
6010:06	Moving negative	Motor turns in negative direction	BOOLEAN	RO	0x00 (0 <sub>dec</sub> )
6010:07	Torque reduced	Reduced torque is active	BOOLEAN	RO	0x00 (0 <sub>dec</sub> )
6010:0C	Digital input 1	Digital input 1	BOOLEAN	RO	0x00 (0 <sub>dec</sub> )
6010:0D	Digital input 2	Digital input 2	BOOLEAN	RO	0x00 (0 <sub>dec</sub> )
6010:0E	Sync error	The Sync error bit is only required for DC mode. It indicates whether a synchronization error has occurred during the previous cycle.	BOOLEAN	RO	0x00 (0 <sub>dec</sub> )
6010:10	TxPDO Toggle	The TxPDO toggle is toggled by the slave when the data of the associated TxPDO is updated.	BOOLEAN	RO	0x00 (0 <sub>dec</sub> )
6010:11	Info data 1	Synchronous information (selection via subindex 0x8012:11 [▶ 99])	UINT16	RO	0x0000 (0 <sub>dec</sub> )
6010:12	Info data 2	Synchronous information (selection via subindex 0x8012:19 [▶ 99])	UINT16	RO	0x0000 (0 <sub>dec</sub> )
6010:14	Internal position	Internal microstep position	UINT32	RO	0x00000000 (0 <sub>dec</sub> )
1010:15	External position	Encoder position	UINT32	RO	0x00000000 (0 <sub>dec</sub> )

## Index 6020 POS Inputs Ch.1

Index (hex)	Name	Meaning	Data type	Flags	Default
6020:0	POS Inputs Ch.1	Maximum subindex	UINT8	RO	0x22 (34 <sub>dec</sub> )
6020:01	Busy	A current travel command is active	BOOLEAN	RO	0x00 (0 <sub>dec</sub> )
6020:02	In-Target	Motor has arrived at target	BOOLEAN	RO	0x00 (0 <sub>dec</sub> )
6020:03	Warning	A warning has occurred	BOOLEAN	RO	0x00 (0 <sub>dec</sub> )
6020:04	Error	an error has occurred	BOOLEAN	RO	0x00 (0 <sub>dec</sub> )
6020:05	Calibrated	Motor is calibrated	BOOLEAN	RO	0x00 (0 <sub>dec</sub> )
6020:06	Accelerate	Motor is in the acceleration phase	BOOLEAN	RO	0x00 (0 <sub>dec</sub> )
6020:07	Decelerate	Motor is in the deceleration phase	BOOLEAN	RO	0x00 (0 <sub>dec</sub> )
6020:08	Ready to execute		BOOLEAN	RO	0x00 (0 <sub>dec</sub> )
6020:11	Actual position	Current target position of the travel command generator	UINT32	RO	0x00007FFF (32767 <sub>dec</sub> )
6020:21	Actual velocity	Current set velocity of the travel command generator	INT16	RO	0x0000 (0 <sub>dec</sub> )
6020:22	Actual drive time	Travel command time information (see subindex 0x8021:11)	UINT32	RO	0x00000000 (0 <sub>dec</sub> )
6020:23	Actual position lag		UINT32	RO	0x00000000 (0 <sub>dec</sub> )

## Index 7000 ENC Outputs Ch.1

Index (hex)	Name	Meaning	Data type	Flags	Default
7000:0	ENC Outputs Ch.1	Maximum subindex	UINT8	RO	0x11 (17 <sub>dec</sub> )
7000:01	Enable latch C	Activate latching via the C-track.	BOOLEAN	RO	0x00 (0 <sub>dec</sub> )
7000:02	Enable latch extern on positive edge	Activate external latch with positive edge.	BOOLEAN	RO	0x00 (0 <sub>dec</sub> )
7000:03	Set counter	Set the counter value.	BOOLEAN	RO	0x00 (0 <sub>dec</sub> )
7000:04	Enable latch extern on negative edge	Activate external latch with negative edge.	BOOLEAN	RO	0x00 (0 <sub>dec</sub> )
7000:11	Set counter value	This is the counter value to be set via "Set counter".	UINT32	RO	0x00000000 (0 <sub>dec</sub> )

## Index 7010 STM Outputs Ch.1

Index (hex)	Name	Meaning	Data type	Flags	Default
7010:0	STM Outputs Ch.1	Maximum subindex	UINT8	RO	0x21 (33 <sub>dec</sub> )
7010:01	Enable	activates the output stage (see subindex 0x8012:3A [► 99])	BOOLEAN	RO	0x00 (0 <sub>dec</sub> )
7010:02	Reset	all errors that may have occurred are reset by setting this bit (rising edge)	BOOLEAN	RO	0x00 (0 <sub>dec</sub> )
7010:03	Reduce torque	Activation of reduced torque (coil current) (see subindex 0x8010:02 [► 98])	BOOLEAN	RO	0x00 (0 <sub>dec</sub> )
7010:0C	Digital output 1	Signal at digital output 1	BOOLEAN	RO	0x00 (0 <sub>dec</sub> )
7010:11	Position	Set position	UINT32	RO	0x00000000 (0 <sub>dec</sub> )
7010:21	Velocity	Set velocity	INT16	RO	0x0000 (0 <sub>dec</sub> )

## Index 7020 POS Outputs Ch.1

Index (hex)	Name	Meaning	Data type	Flags	Default
7020:0	POS Outputs Ch.1	Maximum subindex	UINT8	RO	0x24 (36 <sub>dec</sub> )
7020:01	Execute	Start travel command (rising edge), or prematurely abort travel command (falling edge)	BOOLEAN	RO	0x00 (0 <sub>dec</sub> )
7020:02	Emergency Stop	Prematurely abort travel command with an emergency ramp (rising edge)	BOOLEAN	RO	0x00 (0 <sub>dec</sub> )
7020:11	Target position	Specification of the target position	UINT32	RO	0x00007FFF (32767 <sub>dec</sub> )
7020:21	Velocity	Specification of the maximum set velocity	INT16	RO	0x0000 (0 <sub>dec</sub> )

Index (hex)	Name	Meaning	Data type	Flags	Default			
7020:22	Start type	Specification of the start types	0x0000	Idle	No travel command is being executed	UINT16	RO	0x0000 (0 <sub>dec</sub> )
			0x0001	Absolute	Absolute target position			
			0x0002	Relative	Target position relative to the start position			
			0x0003	Endless plus	Endless driving in positive direction of rotation			
			0x0004	Endless minus	Endless driving in negative direction of rotation			
			0x0105	Modulo short	Shortest distance to the next modulo position			
			0x0115	Modulo short extended	Shortest distance to the next modulo position (without modulo window)			
			0x0205	Modulo plus	Drive in positive direction of rotation to the next modulo position			
			0x0215	Modulo plus extended	Drive in positive direction of rotation to the next modulo position (without modulo window)			
			0x0305	Modulo minus	Drive in negative direction of rotation to the next modulo position			
			0x0315	Modulo minus extended	Drive in negative direction of rotation to the next modulo position (without modulo window)			
			0x0405	Modulo current	Drive in the last implemented direction of rotation to the next modulo position			
			0x0415	Modulo current extended	Drive in the last implemented direction of rotation to the next modulo position (without modulo window)			
			0x0006	Additive	New target position relative/additive to the last target position			
			0x6000	Calibration, Plc cam	Calibration with cam			
			0x6100	Calibration, Hw sync	Calibration with cam and C-track			
0x6E00	Calibration, set manual	Set calibration manually						
0x6E01	Calibration, set manual auto	Set calibration automatically						

Index (hex)	Name	Meaning	Data type	Flags	Default			
			0x6F00	Calibration, clear manual	Clear calibration manually			
7020:23	Acceleration	Acceleration specification				UINT16	RO	0x0000 (0 <sub>dec</sub> )
7020:24	Deceleration	Deceleration specification				UINT16	RO	0x0000 (0 <sub>dec</sub> )

### Index 7021 POS Outputs 2 Ch.1 (part 1)

Index (hex)	Name	Meaning	Data type	Flags	Default value
7021:0	POS Outputs Ch.1	Maximum subindex	UINT8	RO	0x24 (36 <sub>dec</sub> )
7021:03	Enable auto start	Enable auto start	BOOLEAN	RO	0x00 (0 <sub>dec</sub> )
7021:11	Target position	Specification of the target position	UINT32	RO	0x00000000 (0 <sub>dec</sub> )
7021:21	Velocity	Specification of the maximum set velocity	INT16	RO	0x0000 (0 <sub>dec</sub> )

### Index 7021 POS Outputs 2 Ch.1 (part 2)

Index (hex)	Name	Meaning	Data type	Flags	Default value
7021:22	Start type				
	0x0000 Idle: No travel command is being executed		UINT16	RO	0x0000 (0 <sub>dec</sub> )
	0x0001 Absolute: Absolute target position		UINT16	RO	0x0000 (0 <sub>dec</sub> )
	0x1001 Absolute (Change): Change during an active travel command		UINT16	RO	0x0000 (0 <sub>dec</sub> )
	0x0002 Relative: Target position relative to the current position		UINT16	RO	0x0000 (0 <sub>dec</sub> )
	0x1002 Relative (Change): Change during an active travel command		UINT16	RO	0x0000 (0 <sub>dec</sub> )
	0x0003 Endless plus: Endless driving in positive direction of rotation		UINT16	RO	0x0000 (0 <sub>dec</sub> )
	0x0004 Endless minus: Endless driving in negative direction of rotation		UINT16	RO	0x0000 (0 <sub>dec</sub> )
	0x0105 Modulo short: Shortest distance to the next modulo position		UINT16	RO	0x0000 (0 <sub>dec</sub> )
	0x0115 Modulo short extended: Shortest distance to the next modulo position (without modulo window)		UINT16	RO	0x0000 (0 <sub>dec</sub> )
	0x0205 Modulo plus: Drive in positive direction of rotation to the next modulo position		UINT16	RO	0x0000 (0 <sub>dec</sub> )
	0x0215 Modulo plus extended: Drive in positive direction of rotation to the next modulo position (without modulo window)		UINT16	RO	0x0000 (0 <sub>dec</sub> )
	0x0305 Modulo minus: Drive in negative direction of rotation to the next modulo position		UINT16	RO	0x0000 (0 <sub>dec</sub> )
	0x0315 Modulo minus extended: Drive in negative direction of rotation to the next modulo position (without modulo window)		UINT16	RO	0x0000 (0 <sub>dec</sub> )
	0x0405 Modulo current: Drive in the last implemented direction of rotation to the next modulo position		UINT16	RO	0x0000 (0 <sub>dec</sub> )
	0x0415 Modulo current extended: Drive in the last implemented direction of rotation to the next modulo position (without modulo window)		UINT16	RO	0x0000 (0 <sub>dec</sub> )
	0x0006 Additive: New target position relative/additive to the last target position		UINT16	RO	0x0000 (0 <sub>dec</sub> )
	0x1006 Additive (Change): Change during an active travel command		UINT16	RO	0x0000 (0 <sub>dec</sub> )
	0x6000 Calibration, PLC cam: Calibration with cam		UINT16	RO	0x0000 (0 <sub>dec</sub> )
	0x6100 Calibration, HW sync: Calibration with cam and C-track		UINT16	RO	0x0000 (0 <sub>dec</sub> )
	0x6E00 Calibration, set manual: Set calibration manually		UINT16	RO	0x0000 (0 <sub>dec</sub> )
	0x6E01 Calibration, set manual auto: Set automatic calibration, for "Enable = 1"		UINT16	RO	0x0000 (0 <sub>dec</sub> )
	0x6F00 Calibration, clear manual: Clear calibration manually		UINT16	RO	0x0000 (0 <sub>dec</sub> )
7021:23	Acceleration	Acceleration specification	UINT16	RO	0x0000 (0 <sub>dec</sub> )
7021:24	Deceleration	Deceleration specification	UINT16	RO	0x0000 (0 <sub>dec</sub> )

### Index 9010 STM Info data Ch.1

Index (hex)	Name	Meaning	Data type	Flags	Default
9010:0	STM Info data Ch.1	Maximum subindex	UINT8	RO	0x0C (12 <sub>dec</sub> )
9010:01	Status word		UINT16	RO	0x0000 (0 <sub>dec</sub> )
9010:08	Motor velocity		INT16	RO	0x0000 (0 <sub>dec</sub> )
9010:09	Internal position		UINT32	RO	0x00000000 (0 <sub>dec</sub> )
9010:0A	Status word 2		UINT16	RO	0x0000 (0 <sub>dec</sub> )
9010:0B	Motor load		UINT16	RO	0x0000 (0 <sub>dec</sub> )
9010:0C	Motor smart current		UINT8	RO	0x00 (0 <sub>dec</sub> )

**Index 9020 POS Info data Ch.1**

Index (hex)	Motor smart current>Name	Meaning	UINT8>Data type	RO>Flags	0x00 (0 <sub>dec</sub> )>default
9020:0	POS Info data Ch.1	Maximum subindex	UINT8	RO	0x03 (3 <sub>dec</sub> )
9020:01	Status word		UINT16	RO	0x0000 (0 <sub>dec</sub> )
9020:03	State (drive controller)		UINT16	RO	0xFFFF (65535 <sub>dec</sub> )

**Index 9020 POS Info data Ch.1**

Index (hex)	State (drive controller)>Name	Meaning	UINT16>Data type	RO>Flags	0xFFFF (65535 <sub>dec</sub> )>default
9020:0	POS Info data Ch.1	Maximum subindex	UINT8	RO	0x03 (3 <sub>dec</sub> )
9020:01	Status word		UINT16	RO	0x0000 (0 <sub>dec</sub> )
9020:03	State (drive controller)		UINT16	RO	0xFFFF (65535 <sub>dec</sub> )

**Index A010 STM Diag data Ch.1**

Index (hex)	Name	Meaning	Data type	Flags	Default
A010:0	STM Diag data Ch.1	Maximum subindex	UINT8	RO	0x11 (17 <sub>dec</sub> )
A010:01	Saturated		BOOLEAN	RO	0x00 (0 <sub>dec</sub> )
A010:02	Over temperature		BOOLEAN	RO	0x00 (0 <sub>dec</sub> )
A010:03	Torque overload		BOOLEAN	RO	0x00 (0 <sub>dec</sub> )
A010:04	Under voltage		BOOLEAN	RO	0x00 (0 <sub>dec</sub> )
A010:05	Over voltage		BOOLEAN	RO	0x00 (0 <sub>dec</sub> )
A010:06	Short circuit		BOOLEAN	RO	0x00 (0 <sub>dec</sub> )
A010:08	No control power		BOOLEAN	RO	0x00 (0 <sub>dec</sub> )
A010:09	Misc error		BOOLEAN	RO	0x00 (0 <sub>dec</sub> )
A010:0A	Configuration		BOOLEAN	RO	0x00 (0 <sub>dec</sub> )
A010:0B	Motor stall		BOOLEAN	RO	0x00 (0 <sub>dec</sub> )
A010:11	Actual operation mode		BIT4	RO	0x00 (0 <sub>dec</sub> )

**Index A020 POS Diag data Ch.1**

Index (hex)	Name	Meaning	Data type	Flags	Default
A020:0	POS Diag data Ch.1	Maximum subindex	UINT8	RO	0x03 (3 <sub>dec</sub> )
A020:01	Command rejected		BOOLEAN	RO	0x00 (0 <sub>dec</sub> )
A020:02	Command aborted		BOOLEAN	RO	0x00 (0 <sub>dec</sub> )
A020:03	Target overrun		BOOLEAN	RO	0x00 (0 <sub>dec</sub> )

**Index F000 Modular device profile**

Index (hex)	Name	Meaning	Data type	Flags	Default
F000:0	Modular device profile	Maximum sub-index	UINT8	RO	0x02 (2 <sub>dec</sub> )
F000:01	Module index distance	Index distance of the objects of the individual channels	UINT16	RO	0x0010 (16 <sub>dec</sub> )
F000:02	Maximum number of modules	Number of channels	UINT16	RO	0x0003 (3 <sub>dec</sub> )

**Index F008 Code word**

Index (hex)	Name	Meaning	Data type	Flags	Default
F008:0	Code word		UINT32	RW	0x00000000 (0 <sub>dec</sub> )

**Index F010 Module list**

Index (hex)	Name	Meaning	Data type	Flags	Default
F010:0	Module list	Maximum subindex	UINT8	RW	0x03 (3 <sub>dec</sub> )
F010:01	SubIndex 001		UINT32	RW	0x000001FF (511 <sub>dec</sub> )
F010:02	SubIndex 002		UINT32	RW	0x000002BF (703 <sub>dec</sub> )
F010:03	SubIndex 003		UINT32	RW	0x000002C0 (704 <sub>dec</sub> )

**Index F081 Download revision**

Index (hex)	Name	Meaning	Data type	Flags	Default
F081:0	Download revision	Reserved	UINT8	RO	0x01 (1 <sub>dec</sub> )
F081:01	Revision number	Reserved	UINT32	RW	0x00000000 (0 <sub>dec</sub> )

**Index F80F STM Vendor data**

Index (hex)	Name	Meaning	Data type	Flags	Default
F80F:0	STM Vendor data	Maximum subindex	UINT8	RO	0x09 (9 <sub>dec</sub> )
F80F:04	Warning temperature		INT8	RW	0x50 (80 <sub>dec</sub> )
F80F:05	Switch off temperature		INT8	RW	0x64 (100 <sub>dec</sub> )
F80F:09	Maximum current		UINT16	RW	0x1DC9 (7625 <sub>dec</sub> )

**Index F81F STM Vendor data 2**

Index (hex)	Name	Meaning	Data type	Flags	Default
F81F:0	STM Vendor data 2	Maximum subindex	UINT8	RO	0x0A (10 <sub>dec</sub> )
F81F:01	Slope control low side		BIT2	RW	0x00 (0 <sub>dec</sub> )
F81F:03	Slope control high side		BIT2	RW	0x00 (0 <sub>dec</sub> )
F81F:05	Sense voltage		BIT1	RW	0x00 (0 <sub>dec</sub> )
F81F:08	Blank time		BIT2	RW	0x03 (3 <sub>dec</sub> )

**Index F900 STM Info data**

Index (hex)	Name	Meaning	Data type	Flags	Default
F900:0	STM Info data	Maximum subindex	UINT8	RO	0x07 (7 <sub>dec</sub> )
F900:01	Software version (driver)		STRING	RO	
F900:02	Internal temperature		INT8	RO	0x00 (0 <sub>dec</sub> )
F900:04	Control voltage		UINT16	RO	0x0000 (0 <sub>dec</sub> )
F900:05	Motor supply voltage		UINT16	RO	0x0000 (0 <sub>dec</sub> )
F900:06	Cycle time		UINT16	RO	0x0000 (0 <sub>dec</sub> )
F900:07	Motor supply current		UINT16	RO	0x0000 (0 <sub>dec</sub> )



## 8 Appendix

### 8.1 General operating conditions

#### Protection rating according to IP code

The degrees of protection are defined and divided into different classes in the IEC 60529 standard (EN 60529). Degrees of protection are designated by the letters "IP" and two numerals: **IPxy**

- Numeral x: Dust protection and contact protection
- Numeral y: Protection against water

x	Meaning
0	Not protected
1	Protected against access to dangerous parts with the back of the hand. Protected against solid foreign objects of 50 mm Ø
2	Protected against access to dangerous parts with a finger. Protected against solid foreign objects of 12.5 mm Ø
3	Protected against access to dangerous parts with a tool. Protected against solid foreign objects of 2.5 mm Ø
4	Protected against access to dangerous parts with a wire. Protected against solid foreign objects of 1 mm Ø
5	Protection against access to dangerous parts with a wire. Dust-protected. Ingress of dust is not prevented completely, although the quantity of dust able to penetrate is limited to such an extent that the proper function of the device and safety are not impaired
6	Protection against access to dangerous parts with a wire. Dust-tight. No ingress of dust

y	Meaning
0	Not protected
1	Protection against vertically falling water drops
2	Protection against vertically falling water drops when enclosure tilted up to 15°
3	Protection against spraying water. Water sprayed at an angle of up to 60° on either side of the vertical shall have no harmful effects
4	Protection against splashing water. Water splashed against the enclosure from any direction shall have no harmful effects
5	Protection against water jets.
6	Protection against powerful water jets.
7	Protected against the effects of temporary immersion in water. Ingress of water in quantities causing harmful effects shall not be possible when the enclosure is immersed in water at a depth of 1 m for 30 minutes

#### Chemical resistance

The resistance refers to the housing of the IP67 modules and the metal parts used. In the table below you will find some typical resistances.

Type	Resistance
Water vapor	unstable at temperatures > 100 °C
Sodium hydroxide solution (ph value > 12)	stable at room temperature unstable > 40 °C
Acetic acid	unstable
Argon (technically pure)	stable

#### Key

- resistant: Lifetime several months
- non inherently resistant: Lifetime several weeks
- not resistant: Lifetime several hours resp. early decomposition

## 8.2 Accessories

### Mounting

Ordering information	Description	Link
ZS5300-0011	Mounting rail	<a href="#">Website</a>

### Cables

A complete overview of pre-assembled cables for fieldbus components can be found [here](#).

Ordering information	Description	Link
ZK1090-3xxx-xxxx	EtherCAT cable M8, green	<a href="#">Website</a>
ZK1093-3xxx-xxxx	EtherCAT cable M8, yellow	<a href="#">Website</a>
ZK2000-5xxx-xxxx	Sensor cable M12, 5-pin	<a href="#">Website</a>
ZK2020-3xxx-xxxx	Power cable M8, 4-pin	<a href="#">Website</a>
ZK4000-51xx-xxxx	Encoder cable, shielded	<a href="#">Website</a>
ZK4000-6xxx-xxxx	Motor cable	<a href="#">Website</a>

### Labeling material, protective caps

Ordering information	Description
ZS5000-0010	Protective cap for M8 sockets, IP67 (50 pieces)
ZS5000-0020	Protective cap for M12 sockets, IP67 (50 pcs.)
ZS5100-0000	Inscription labels, unprinted, 4 strips of 10
ZS5000-xxxx	Printed inscription labels on enquiry

### Tools

Ordering information	Description
ZB8801-0000	Torque wrench for plugs, 0.4...1.0 Nm
ZB8801-0001	Torque cable key for M8 / wrench size 9 for ZB8801-0000
ZB8801-0002	Torque cable key for M12 / wrench size 13 for ZB8801-0000
ZB8801-0003	Torque cable key for M12 field assembly / wrench size 18 for ZB8801-0000



#### Further accessories

Further accessories can be found in the price list for fieldbus components from Beckhoff and online at <https://www.beckhoff.com>.

## 8.3 Version identification of EtherCAT devices

### 8.3.1 General notes on marking

#### Designation

A Beckhoff EtherCAT device has a 14-digit designation, made up of

- family key
- type
- version
- revision

Example	Family	Type	Version	Revision
EL3314-0000-0016	EL terminal 12 mm, non-pluggable connection level	3314 4-channel thermocouple terminal	0000 basic type	0016
ES3602-0010-0017	ES terminal 12 mm, pluggable connection level	3602 2-channel voltage measurement	0010 high-precision version	0017
CU2008-0000-0000	CU device	2008 8-port fast ethernet switch	0000 basic type	0000

#### Notes

- The elements mentioned above result in the **technical designation**. EL3314-0000-0016 is used in the example below.
- EL3314-0000 is the order identifier, in the case of "-0000" usually abbreviated to EL3314. "-0016" is the EtherCAT revision.
- The **order identifier** is made up of
  - family key (EL, EP, CU, ES, KL, CX, etc.)
  - type (3314)
  - version (-0000)
- The **revision** -0016 shows the technical progress, such as the extension of features with regard to the EtherCAT communication, and is managed by Beckhoff.  
In principle, a device with a higher revision can replace a device with a lower revision, unless specified otherwise, e.g. in the documentation.  
Associated and synonymous with each revision there is usually a description (ESI, EtherCAT Slave Information) in the form of an XML file, which is available for download from the Beckhoff web site.  
From 2014/01 the revision is shown on the outside of the IP20 terminals, see Fig. "EL5021 EL terminal, standard IP20 IO device with batch number and revision ID (since 2014/01)".
- The type, version and revision are read as decimal numbers, even if they are technically saved in hexadecimal.

### 8.3.2 Version identification of IP67 modules

The serial number/ data code for Beckhoff IO devices is usually the 8-digit number printed on the device or on a sticker. The serial number indicates the configuration in delivery state and therefore refers to a whole production batch, without distinguishing the individual modules of a batch.

Structure of the serial number: **KK YY FF HH**

KK - week of production (CW, calendar week)

YY - year of production

FF - firmware version

HH - hardware version

Example with serial number 12 06 3A 02:

12 - production week 12

06 - production year 2006

3A - firmware version 3A

02 - hardware version 02

Exceptions can occur in the **IP67 area**, where the following syntax can be used (see respective device documentation):

Syntax: D ww yy x y z u

D - prefix designation

ww - calendar week

yy - year

x - firmware version of the bus PCB

y - hardware version of the bus PCB

z - firmware version of the I/O PCB

u - hardware version of the I/O PCB

Example: D.22081501 calendar week 22 of the year 2008 firmware version of bus PCB: 1 hardware version of bus PCB: 5 firmware version of I/O PCB: 0 (no firmware necessary for this PCB) hardware version of I/O PCB: 1

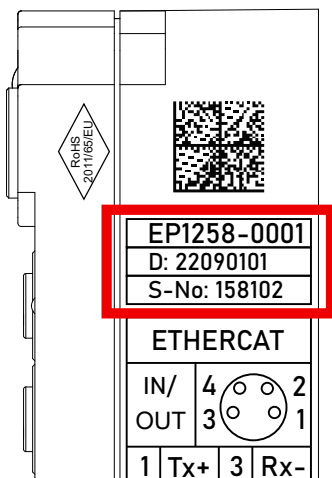

Fig. 51: EP1258-00001 IP67 EtherCAT Box with batch number/DateCode 22090101 and unique serial number 158102

### 8.3.3 Beckhoff Identification Code (BIC)

The Beckhoff Identification Code (BIC) is increasingly being applied to Beckhoff products to uniquely identify the product. The BIC is represented as a Data Matrix Code (DMC, code scheme ECC200), the content is based on the ANSI standard MH10.8.2-2016.

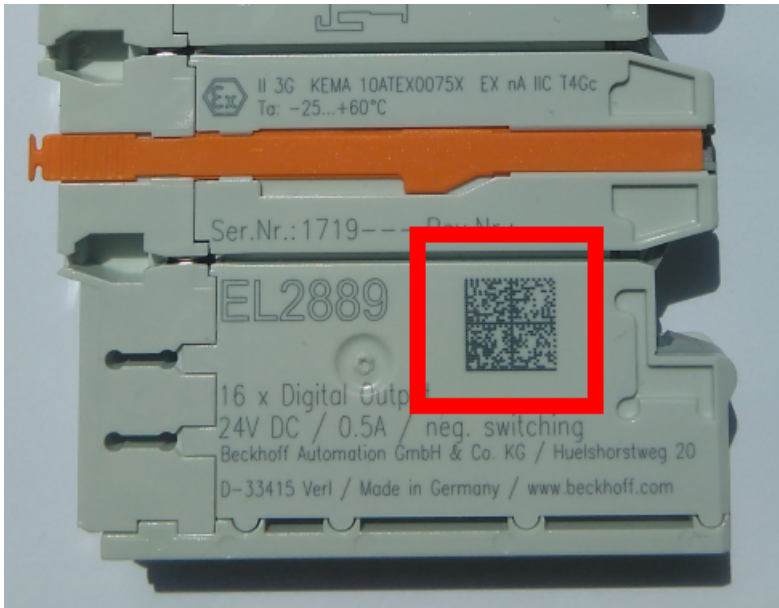

Fig. 52: BIC as data matrix code (DMC, code scheme ECC200)

The BIC will be introduced step by step across all product groups.

Depending on the product, it can be found in the following places:

- on the packaging unit
- directly on the product (if space suffices)
- on the packaging unit and the product

The BIC is machine-readable and contains information that can also be used by the customer for handling and product management.

Each piece of information can be uniquely identified using the so-called data identifier (ANSI MH10.8.2-2016). The data identifier is followed by a character string. Both together have a maximum length according to the table below. If the information is shorter, spaces are added to it.

Following information is possible, positions 1 to 4 are always present, the other according to need of production:

Position	Type of information	Explanation	Data identifier	Number of digits incl. data identifier	Example
1	Beckhoff order number	<b>Beckhoff order number</b>	1P	8	<b>1P</b> 072222
2	Beckhoff Traceability Number (BTN)	<b>Unique serial number, see note below</b>	SBTN	12	<b>S</b> BTNk4p562d7
3	Article description	<b>Beckhoff article description, e.g. EL1008</b>	1K	32	<b>1K</b> EL1809
4	Quantity	<b>Quantity in packaging unit, e.g. 1, 10, etc.</b>	Q	6	<b>Q</b> 1
5	Batch number	Optional: Year and week of production	2P	14	<b>2P</b> 401503180016
6	ID/serial number	Optional: Present-day serial number system, e.g. with safety products	51S	12	<b>51S</b> 678294
7	Variant number	Optional: Product variant number on the basis of standard products	30P	32	<b>30P</b> F971, 2*K183
...					

Further types of information and data identifiers are used by Beckhoff and serve internal processes.

### Structure of the BIC

Example of composite information from positions 1 to 4 and with the above given example value on position 6. The data identifiers are highlighted in bold font:

**1P**072222**S**BTNk4p562d7**1K**EL1809 **Q**1 **51S**678294

Accordingly as DMC:



Fig. 53: Example DMC **1P**072222**S**BTNk4p562d7**1K**EL1809 **Q**1 **51S**678294

### BTN

An important component of the BIC is the Beckhoff Traceability Number (BTN, position 2). The BTN is a unique serial number consisting of eight characters that will replace all other serial number systems at Beckhoff in the long term (e.g. batch designations on IO components, previous serial number range for safety products, etc.). The BTN will also be introduced step by step, so it may happen that the BTN is not yet coded in the BIC.

### NOTICE

This information has been carefully prepared. However, the procedure described is constantly being further developed. We reserve the right to revise and change procedures and documentation at any time and without prior notice. No claims for changes can be made from the information, illustrations and descriptions in this information.

### 8.3.4 Electronic access to the BIC (eBIC)

#### Electronic BIC (eBIC)

The Beckhoff Identification Code (BIC) is applied to the outside of Beckhoff products in a visible place. If possible, it should also be electronically readable.

The interface that the product can be electronically addressed by is crucial for the electronic readout.

#### EtherCAT devices (IP20, IP67)

All Beckhoff EtherCAT devices have an ESI-EEPROM which contains the EtherCAT identity with the revision number. The EtherCAT slave information, also colloquially known as the ESI/XML configuration file for the EtherCAT master, is stored in it. See the corresponding chapter in the EtherCAT system manual ([Link](#)) for the relationships.

Beckhoff also stores the eBIC in the ESI-EEPROM. The eBIC was introduced into Beckhoff IO production (terminals, box modules) in 2020; as of 2023, implementation is largely complete.

The user can electronically access the eBIC (if present) as follows:

- With all EtherCAT devices, the EtherCAT master (TwinCAT) can read the eBIC from the ESI-EEPROM
  - From TwinCAT 3.1 build 4024.11, the eBIC can be displayed in the online view.
  - To do this, check the "Show Beckhoff Identification Code (BIC)" checkbox under EtherCAT → Advanced Settings → Diagnostics:

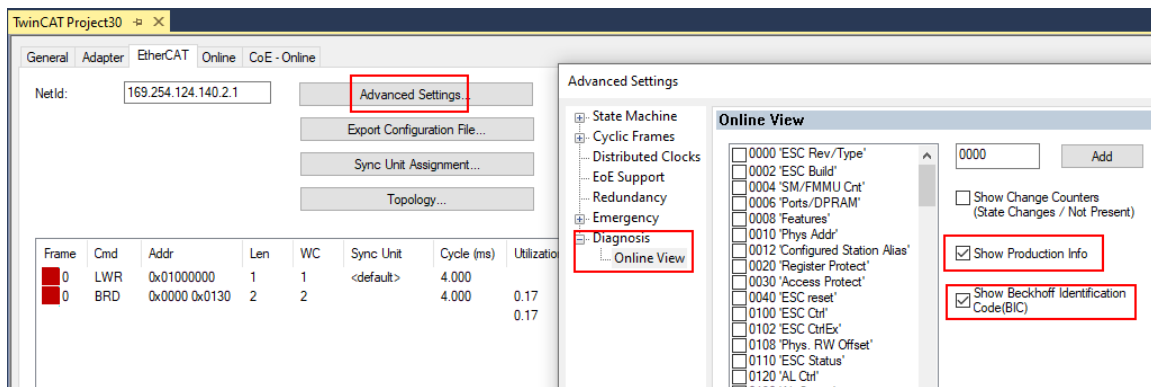

- The BTN and its contents are then displayed:

No	Addr	Name	State	CRC	Fw	Hw	Production Data	ItemNo	BTN	Description	Quantity	BatchNo	SerialNo
1	1001	Term 1 (EK1100)	OP	0,0	0	0	---						
2	1002	Term 2 (EL1018)	OP	0,0	0	0	2020 KW36 Fr	072222	k4p562d7	EL1809	1		678294
3	1003	Term 3 (EL3204)	OP	0,0	7	6	2012 KW24 Sa						
4	1004	Term 4 (EL2004)	OP	0,0	0	0	---	072223	k4p562d7	EL2004	1		678295
5	1005	Term 5 (EL1008)	OP	0,0	0	0	---						
6	1006	Term 6 (EL2008)	OP	0,0	0	12	2014 KW14 Mo						
7	1007	Term 7 (EK1110)	OP	0	1	8	2012 KW25 Mo						

- Note: As shown in the figure, the production data HW version, FW version, and production date, which have been programmed since 2012, can also be displayed with "Show production info".
- Access from the PLC: From TwinCAT 3.1. build 4024.24, the functions *FB\_EcReadBIC* and *FB\_EcReadBTN* for reading into the PLC are available in the Tc2\_EtherCAT library from v3.3.19.0.
- EtherCAT devices with a CoE directory may also have the object 0x10E2:01 to display their own eBIC, which can also be easily accessed by the PLC:

- The device must be in PREOP/SAFEOP/OP for access:

Index	Name	Flags	Value
1000	Device type	RO	0x015E1389 (22942601)
1008	Device name	RO	ELM3704-0000
1009	Hardware version	RO	00
100A	Software version	RO	01
100B	Bootloader version	RO	J0.1.27.0
1011:0	Restore default parameters	RO	> 1 <
1018:0	Identity	RO	> 4 <
10E2:0	Manufacturer-specific Identification C...	RO	> 1 <
10E2:01	SubIndex 001	RO	1P158442SBTN0008jckp1KELM3704 Q1 2P482001000016
10F0:0	Backup parameter handling	RO	> 1 <
10F3:0	Diagnosis History	RO	> 21 <
10F8	Actual Time Stamp	RO	0x170bfb277e

- The object 0x10E2 will be preferentially introduced into stock products in the course of necessary firmware revision.
- From TwinCAT 3.1. build 4024.24, the functions *FB\_EcCoEReadBIC* and *FB\_EcCoEReadBTN* for reading into the PLC are available in the *Tc2\_EtherCAT* library from v3.3.19.0
- The following auxiliary functions are available for processing the BIC/BTN data in the PLC in *Tc2\_Uilities* as of TwinCAT 3.1 build 4024.24
  - *F\_SplitBIC*: The function splits the Beckhoff Identification Code (BIC) *sBICValue* into its components using known identifiers and returns the recognized substrings in the *ST\_SplittedBIC* structure as a return value
  - *BIC\_TO\_BTN*: The function extracts the BTN from the BIC and returns it as a return value
- Note: If there is further electronic processing, the BTN is to be handled as a string(8); the identifier "SBTN" is not part of the BTN.
- Technical background  
The new BIC information is written as an additional category in the ESI-EEPROM during device production. The structure of the ESI content is largely dictated by the ETG specifications, therefore the additional vendor-specific content is stored using a category in accordance with the ETG.2010. ID 03 tells all EtherCAT masters that they may not overwrite these data in the event of an update or restore the data after an ESI update.  
The structure follows the content of the BIC, see here. The EEPROM therefore requires approx. 50..200 bytes of memory.
- Special cases
  - If multiple hierarchically arranged ESCs are installed in a device, only the top-level ESC carries the eBIC information.
  - If multiple non-hierarchically arranged ESCs are installed in a device, all ESCs carry the eBIC information.
  - If the device consists of several sub-devices which each have their own identity, but only the top-level device is accessible via EtherCAT, the eBIC of the top-level device is located in the CoE object directory 0x10E2:01 and the eBICs of the sub-devices follow in 0x10E2:nn.



## 8.4 Support and Service

Beckhoff and their partners around the world offer comprehensive support and service, making available fast and competent assistance with all questions related to Beckhoff products and system solutions.

### Beckhoff's branch offices and representatives

Please contact your Beckhoff branch office or representative for local support and service on Beckhoff products!

The addresses of Beckhoff's branch offices and representatives round the world can be found on her internet pages: [www.beckhoff.com](http://www.beckhoff.com)

You will also find further documentation for Beckhoff components there.

### Support

The Beckhoff Support offers you comprehensive technical assistance, helping you not only with the application of individual Beckhoff products, but also with other, wide-ranging services:

- support
- design, programming and commissioning of complex automation systems
- and extensive training program for Beckhoff system components

Hotline: +49 5246 963 157  
e-mail: [support@beckhoff.com](mailto:support@beckhoff.com)  
web: [www.beckhoff.com/support](http://www.beckhoff.com/support)

### Service

The Beckhoff Service Center supports you in all matters of after-sales service:

- on-site service
- repair service
- spare parts service
- hotline service

Hotline: +49 5246 963 460  
e-mail: [service@beckhoff.com](mailto:service@beckhoff.com)  
web: [www.beckhoff.com/service](http://www.beckhoff.com/service)

### Headquarters Germany

Beckhoff Automation GmbH & Co. KG

Hülshorstweg 20  
33415 Verl  
Germany

Phone: +49 5246 963 0  
e-mail: [info@beckhoff.com](mailto:info@beckhoff.com)  
web: [www.beckhoff.com](http://www.beckhoff.com)



Beckhoff Automation GmbH & Co. KG  
Hülshorstweg 20  
33415 Verl  
Germany  
Phone: +49 5246 9630  
[info@beckhoff.com](mailto:info@beckhoff.com)  
[www.beckhoff.com](http://www.beckhoff.com)