

Operating Instructions | EN

EP2918-0032 and EP2918-2232

TwinSAFE EtherCAT Box with 8 fail-safe outputs



Table of contents

1	Notes on the documentation.....	5
1.1	Disclaimer.....	5
1.1.1	Trademarks.....	5
1.1.2	Patents.....	5
1.1.3	Limitation of liability.....	6
1.1.4	Copyright.....	6
1.2	Documentation issue status.....	7
1.3	Version history of the TwinSAFE product.....	8
1.4	Staff qualification.....	8
1.5	Safety and instruction.....	9
1.5.1	Explanation of symbols.....	9
1.6	Beckhoff Support and Service.....	10
2	For your safety.....	11
2.1	Duty of care.....	11
2.2	Safety image signs.....	12
2.3	General safety instructions.....	13
2.3.1	Before operation.....	13
2.3.2	In operation.....	13
2.3.3	After operation.....	13
3	System description.....	14
3.1	EtherCAT Box Modules.....	14
4	Product description.....	15
4.1	EP2918-0032 and EP2918-2232.....	15
4.2	Intended use.....	16
4.3	Technical data.....	17
4.4	Safety parameters.....	18
4.5	Safe output.....	19
4.6	Dimensions.....	19
5	Operation.....	21
5.1	Environmental conditions.....	21
5.2	Installation.....	21
5.2.1	Fixing.....	21
5.2.2	Connection.....	21
5.2.3	Temperature measurement.....	27
5.2.4	Signal cables.....	28
5.3	Configuration of the EtherCAT Box in TwinCAT.....	30
5.3.1	Adding an EtherCAT device.....	30
5.3.2	Inserting an EP2918.....	30
5.3.3	EP2918-0032: using the integrated TwinSAFE Logic functions.....	30
5.3.4	Address settings on the TwinSAFE EtherCAT Box.....	32
5.3.5	Alias devices.....	33
5.3.6	EP2918 parameters.....	35
5.3.7	Process image of the EP2918.....	38

5.4	TwinSAFE reaction times	39
5.5	Diagnostics	41
5.5.1	EtherCAT- Fieldbus LEDs	41
5.5.2	Status LEDs	42
5.5.3	Diagnostic LEDs	43
5.5.4	Flash code display	44
5.5.5	Diagnostic objects	44
5.5.6	Cycle time of the safety project	45
5.5.7	Diag History tab	46
5.5.8	Diagnosis History	47
6	Service life	50
7	Maintenance and cleaning	51
8	Decommissioning	52
8.1	Disposal	52
8.1.1	Returning to the vendor	52
9	Appendix	53
9.1	Protection classes according to IP code	53
9.2	Volatility	54
9.3	Focus of certificates	55
9.4	Certificate	56

1 Notes on the documentation

1.1 Disclaimer

Beckhoff products are subject to continuous further development. We reserve the right to revise the operating instructions at any time and without prior announcement. No claims for the modification of products that have already been supplied may be made on the basis of the data, diagrams and descriptions in these operating instructions.

In these operating instructions we define all permissible use cases whose properties and operating conditions we can guarantee. The use cases we define are fully tested and certified. Use cases beyond this, which are not described in these operating instructions, require the approval of Beckhoff Automation GmbH & Co KG.

1.1.1 Trademarks

Beckhoff®, TwinCAT®, EtherCAT®, EtherCAT G®, EtherCAT G10®, EtherCAT P®, Safety over EtherCAT®, TwinSAFE®, XFC®, XTS® and XPlanar® are registered and licensed trademarks of Beckhoff Automation GmbH.

The use of other brand names or designations by third parties may lead to an infringement of the rights of the owners of the corresponding designations.

1.1.2 Patents

The EtherCAT technology is protected by patent rights through the following registrations and patents with corresponding applications and registrations in various other countries:

- EP1590927
- EP1789857
- EP1456722
- EP2137893
- DE102015105702



EtherCAT® is a registered trademark and patented technology, licensed by Beckhoff Automation GmbH.



Safety over EtherCAT® is a registered trademark and patented technology, licensed by Beckhoff Automation GmbH.

1.1.3 Limitation of liability

All components in this product as described in the operating instructions are delivered in a specific configuration of hardware and software, depending on the application regulations. Modifications and changes to the hardware and/or software configuration that go beyond the documented options are prohibited and nullify the liability of Beckhoff Automation GmbH & Co. KG.

The following is excluded from the liability:

- Failure to observe these operating instructions
- Improper use
- Use of untrained personnel
- Use of unauthorized spare parts

1.1.4 Copyright

© Beckhoff Automation GmbH & Co. KG, Germany.

The distribution and reproduction of this document as well as the use and communication of its contents without express authorization are prohibited.

Offenders will be held liable for the payment of damages. All rights reserved in the event of the grant of a patent, utility model or design.

1.2 Documentation issue status

Version	Comment
2.0.0	<ul style="list-style-type: none"> • Foreword changed to Notes on the documentation [▶ 5] and For your safety [▶ 11] • Service life [▶ 50] moved • Maintenance and cleaning [▶ 51] and Decommissioning [▶ 52] adapted • Appendix adapted and expanded
1.2.1	<ul style="list-style-type: none"> • Typo in Technical data [▶ 17] corrected
1.2.0	<ul style="list-style-type: none"> • In chapter Technical data [▶ 17] link to download page of certificates added • Chapter "Firmware update of TwinSAFE products" removed • I/O component EP2918-2232 added as variant of EP2918-0032 • Chapter Temperature measurement [▶ 27] renamed • Chapter Project design limits of the EP2918 [▶ 31] moved • Some figures renamed
1.1.0	<ul style="list-style-type: none"> • Chapter Decommissioning updated
1.0.0	<ul style="list-style-type: none"> • First release
0.6	<ul style="list-style-type: none"> • Safety-related data updated • EN81 notes removed • Maximum temperature entered
0.5	<ul style="list-style-type: none"> • Data for the functional overcurrent cut-off added
0.4	<ul style="list-style-type: none"> • Technical data updated
0.3	<ul style="list-style-type: none"> • Note on commissioning test added • Note on safe output added
0.2	<ul style="list-style-type: none"> • Revision following review • EN81 notes on TwinSAFE EtherCAT Boxes adapted • Derating information added
0.1	<ul style="list-style-type: none"> • First draft

Currentness

Please check whether you are using the current and valid version of this document. The current version can be downloaded from the Beckhoff homepage at <http://www.beckhoff.de/twinsafe>. In case of doubt, please contact Technical Support (see [Beckhoff Support and Service \[▶ 10\]](#)).

Origin of the document

The original documentation is written in German. All other languages are derived from the German original.

Product features

Only the product properties specified in the current operating instructions are valid. Further information given on the product pages of the Beckhoff homepage, in emails or in other publications is not authoritative.

1.3 Version history of the TwinSAFE product

This version history lists the software and hardware version numbers. A description of the changes compared to the previous version is also given.

● Updated hardware and software

i TwinSAFE products are subject to a cyclical revision. We reserve the right to revise and change the TwinSAFE products at any time and without prior notice.

No claims for changes to products already delivered can be asserted from these hardware and/or software changes.

Date	Software version	Hardware version	Modifications
			First release of the EP2918-2232
14/11/2019	01	00	First release of the EP2918-0032

1.4 Staff qualification

These operating instructions are intended exclusively for trained specialists in control technology and automation with the relevant knowledge.

The trained specialist personnel must ensure that the applications and use of the described product meet all safety requirements. This includes all applicable and valid laws, regulations, provisions and standards.

Trained specialists

Trained specialists have extensive technical knowledge from studies, apprenticeships or technical training. Understanding of control technology and automation is available. Trained specialists can:

- Independently identify, avoid and eliminate sources of hazard.
- Apply relevant standards and directives.
- Implement specifications from accident prevention regulations.
- Evaluate, prepare and set up the workplaces.
- Evaluate, optimize and execute work independently.

1.5 Safety and instruction

Read the contents that refer to the activities you have to perform with the product. Always read the chapter [For your safety \[▶ 11\]](#) in the operating instructions.

Observe the warnings in the chapters so that you can handle and work with the product as intended and safely.

1.5.1 Explanation of symbols

Various symbols are used for a clear arrangement:

1. The numbering indicates an action that should be taken.
 - The bullet point indicates an enumeration.
- [...] The square brackets indicate cross-references to other text passages in the document.
- [1] The number in square brackets indicates the numbering of a referenced document.

1.5.1.1 Pictograms

In order to make it easier for you to find text passages, pictograms and signal words are used in warning notices:

DANGER

Failure to observe will result in serious or fatal injuries.

WARNING

Failure to observe may result in serious or fatal injuries.

CAUTION

Failure to observe may result in minor or moderate injuries.

NOTE

Notes

Notes are used for important information on the product. The possible consequences of failure to observe these include:

- Malfunctions of the product
- Damage to the product
- Damage to the environment

Information

This sign indicates information, tips and notes for dealing with the product or the software.

1.6 Beckhoff Support and Service

Support

Beckhoff Support offers technical advice on the use of individual Beckhoff products and system planning. The employees support you in the programming and commissioning of sophisticated automation systems.

Hotline: +49 5246/963-157
E-mail: support@beckhoff.com
Web: www.beckhoff.com/support

Training

Training in Germany takes place in our training center at the Beckhoff headquarters in Verl, at subsidiaries or, by arrangement, at the customer's premises.

Hotline: +49 5246/963-5000
E-mail: training@beckhoff.com
Web: www.beckhoff.com/training

Service

The Beckhoff Service Center supports you with after-sales services such as on-site service, repair service or spare parts service.

Hotline: +49 5246/963-460
E-mail: service@beckhoff.com
Web: www.beckhoff.com/service

Download area

In the download area you can obtain product information, software updates, the TwinCAT automation software, documentation and much more.

Web: www.beckhoff.com/download

Headquarters

Beckhoff Automation GmbH & Co. KG
Hülshorstweg 20
33415 Verl
Germany

Phone: +49 5246/963-0
E-mail: info@beckhoff.com
Web: www.beckhoff.com

For the addresses of our worldwide locations, please visit our website at [Global Presence](#).

2 For your safety

Read this chapter containing general safety information. In addition, always observe the safety instructions and warnings in these operating instructions for your own safety, the safety of other persons and the safety of the product.

When working with control and automation products, many dangers can result from careless or incorrect use. Work particularly thoroughly, not under time pressure and responsibly towards other people.

2.1 Duty of care



Read entire documentation for TwinSAFE component

- TwinSAFE application manual
- EL6910 TwinSAFE logic terminal operating manual
- TwinSAFE Logic FB documentation manual

The operator must comply with all the requirements and notes specified in these operating instructions in order to fulfill his duty of care. This includes in particular that you

- comply with the provisions defined in the chapter [Limitation of liability](#) [▶ 6].
- only operate the TwinSAFE component when it is in perfect working order.
- provide the operating instructions in a legible condition and complete at the place of use of the TwinSAFE component.
- do not remove the safety markings attached to the TwinSAFE component and maintain their legibility.





No disposal in domestic waste

Products marked with a crossed-out waste bin must not be disposed of with domestic waste. The device is considered waste electrical and electronic equipment when it is disposed of. Observe the national regulations for the disposal of waste electrical and electronic equipment.

2.2 Safety image signs

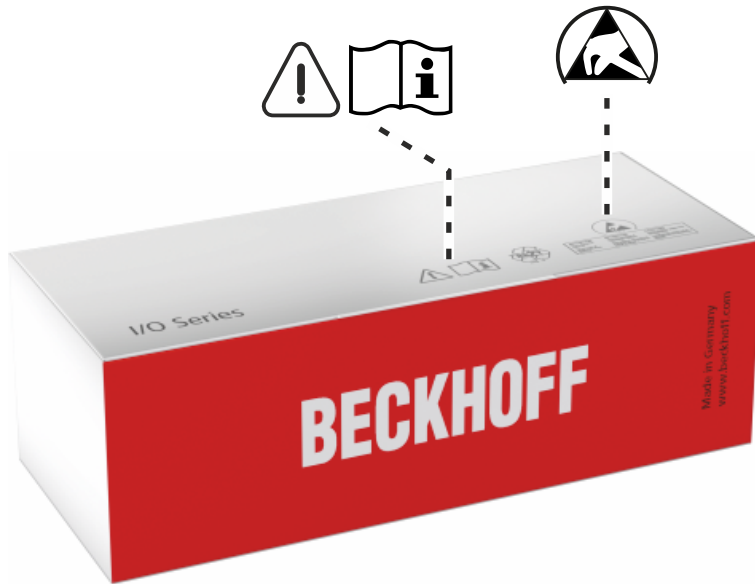
On Beckhoff products you will find attached or lasered safety pictograms, which vary depending on the product. They serve to ensure safety for people and to prevent damage to the products. Safety pictograms must not be removed and must be legible for the user.



-  **Read and observe the operating instructions**
Commissioning is only permitted if the operating instructions have been read and understood beforehand. This applies in particular to the safety instructions and warnings.

-  **Electrostatic sensitive components**
Work with and on the TwinSAFE component is only permitted in protected workplaces.

2.3 General safety instructions

2.3.1 Before operation

Use in machines according to the Machinery Directive

Only use the TwinSAFE component in machines that comply with the Machinery Directive. This is how you ensure safe operation.

Ensure traceability

Ensure the traceability of the TwinSAFE component via the serial number.

Use SELV/PELV power supply

Use a SELV/PELV power supply unit with an output-side voltage limit of $U_{\max} = 36 V_{DC}$ to supply the TwinSAFE component with $24 V_{DC}$.

Failure to observe this will endanger the safety function of the product. Depending on the machine, death and danger to life, serious physical injury and damage to the machine may result.

Carry out commissioning test

Before commissioning, wiring faults to the sensors must be excluded. Before commissioning, carry out a commissioning test. After a successful commissioning test, you can use the TwinSAFE component for the intended safety-related task.

In case of wiring errors, the safety function of the product is at risk. Depending on the machine, death and danger to life, serious bodily injury and damage to the machine may result.

Use permitted engineering tools and procedures

The TÜV SÜD certificate applies to the TwinSAFE component, the function blocks available in it, the documentation and the engineering tool. TwinCAT 3.1 and the TwinSAFE Loader are permitted as engineering tools.

Procedures or engineering tools deviating from this are not covered by the certificate. This applies in particular to externally generated xml files for the TwinSAFE import.

2.3.2 In operation

Interference due to emitted interference

Do not operate the following devices in the vicinity of the TwinSAFE component: for example, radio telephones, radios, transmitters or high-frequency systems.

TwinSAFE components comply with the requirements of the applicable electromagnetic compatibility standards with regard to interference emission and immunity. If you exceed the limits for emitted interference specified in the standards, the function of the TwinSAFE component may be impaired.

2.3.3 After operation

De-energize and switch off components before working on them

Check all safety-relevant equipment for functionality before working on the TwinSAFE component. Secure the working environment. Secure the machine or plant against being inadvertently started up. Observe the chapter [Decommissioning](#) [► 52].

3 System description

3.1 EtherCAT Box Modules

The EtherCAT system has been extended with EtherCAT Box modules with protection class IP67. Through the integrated EtherCAT interface the modules can be connected directly to an EtherCAT network without an additional Coupler Box. The high-performance of EtherCAT is thus maintained into each module.

The extremely low dimensions of only e.g. 126 x 30 x 26.5 mm are identical to those of the Fieldbus Box extension modules. They are thus particularly suitable for use where space is at a premium. The small mass of the EtherCAT modules facilitates applications with mobile I/O interface (e.g. on a robot arm). The EtherCAT connection is established via screened M8 connectors.

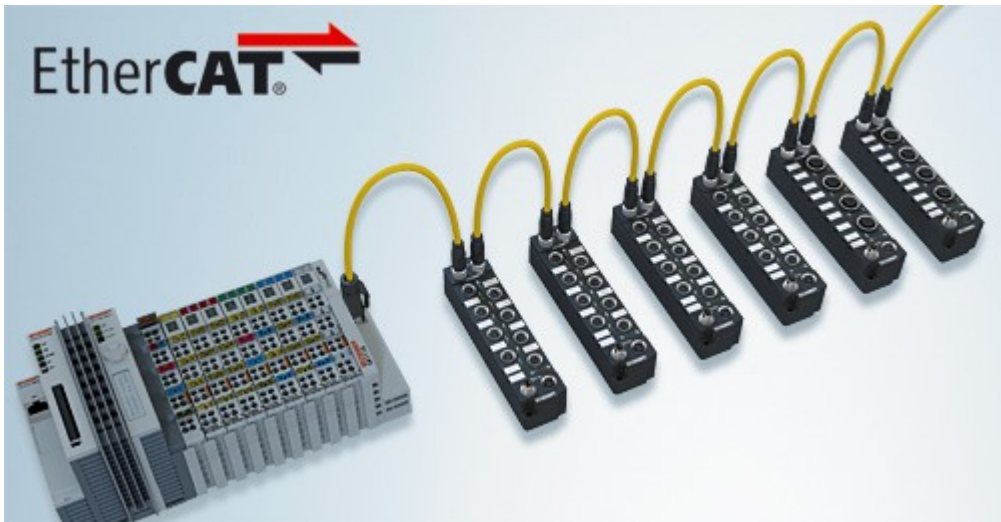

Fig. 1: EtherCAT Box modules extend the EtherCAT system with IP67 protection

The robust design of the EtherCAT Box modules enables them to be used directly at the machine. Control cabinets and terminal boxes are now no longer required. The modules are fully sealed and therefore ideally prepared for wet, dirty or dusty conditions.

Pre-assembled cables significantly simplify EtherCAT and signal wiring. Very few wiring errors are made, so that commissioning is optimized. In addition to pre-assembled EtherCAT, power and sensor cables, field-configurable connectors and cables are available for maximum flexibility. Depending on the application, the sensors and actuators are connected through M8 or M12 connectors.

● Basic EtherCAT documentation



You will find a detailed description of the EtherCAT system in the Basic System Documentation for EtherCAT, which is available for download from our website (www.beckhoff.com) under *Downloads*.

4 Product description

4.1 EP2918-0032 and EP2918-2232

The EP2918 is an EtherCAT Box with digital outputs for 24 V_{DC} actuators. The EtherCAT Box has 8 fail-safe outputs, each with a maximum output current of 2 A (at 24 V_{DC}).

The EL2918 meets the requirements of the following standards:

- EN 61508:2010 (SIL 3)
- EN 62061:2005/A2:2015 (SIL CL 3)
- EN ISO 13849-1:2015 (Cat. 4, PL e)

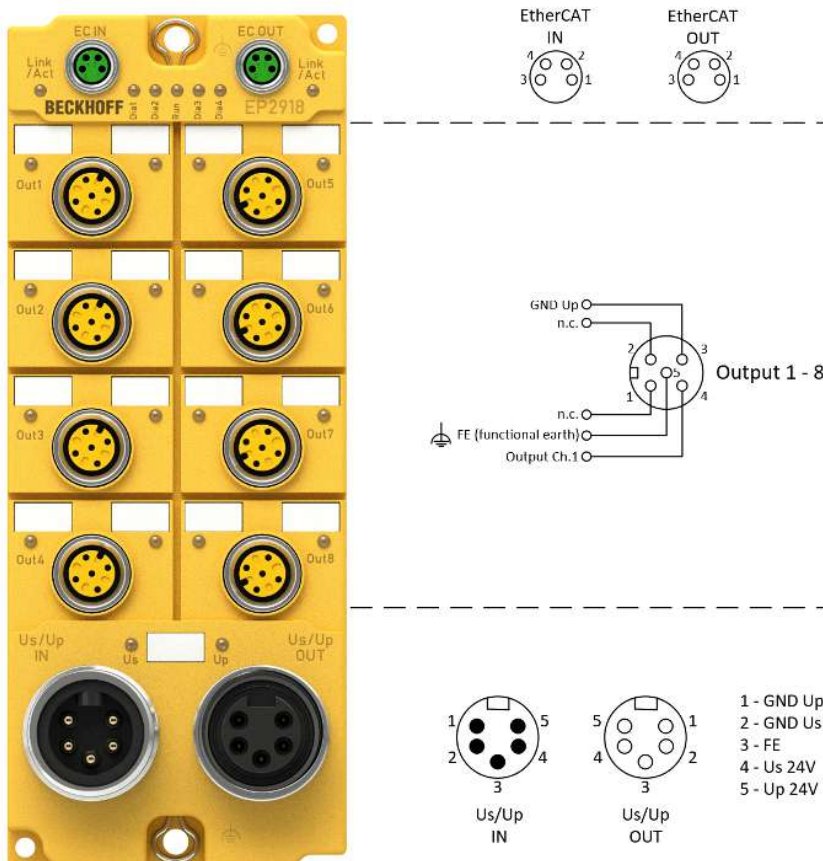

Fig. 2: EP2918 – TwinSAFE EtherCAT Box with 8 fail-safe outputs

The TwinSAFE EtherCAT Box has the usual design of an EtherCAT Box with a width of 60 mm and a height of 150 mm.

i EP2918 variants

The EP2918 has an integrated safety control that can be used for user-specific applications directly on the component. The variant EP2918-2232 does not have this functionality and represents a pure I/O component.

4.2 Intended use

⚠ WARNING

Caution - Risk of injury!

TwinSAFE components shall only be used for the purposes described below!

The TwinSAFE EtherCAT Box expands the application range of the Beckhoff system with functions that enable it to be used for machine safety applications. The TwinSAFE Boxes are designed for machine safety functions and directly associated industrial automation tasks. They are therefore only approved for applications with a defined fail-safe state. This safe state is the wattless state. Fail-safety according to the relevant standards is required.

The TwinSAFE EtherCAT Box allows the connection of:

24 V_{DC} actuators such as

- contactors, protective door switches with tumblers, valves etc.

⚠ WARNING

The fail-safe principle!

The basic rule for a safety system such as TwinSAFE is that failure of a part, a system component or the overall system must never lead to a dangerous condition. The safe state is always the switched off and wattless state.

⚠ WARNING

Power supply from SELV/PELV power supply unit!

The TwinSAFE components must be supplied with 24 V_{DC} by an SELV/PELV power supply unit with an output voltage limit U_{max} of 36 V_{DC}. Failure to observe this can result in a loss of safety.

⚠ WARNING

System limits

The TÜV SÜD certificate applies to this TwinSAFE component, the function blocks available in it, the documentation and the engineering tool. *TwinCAT 3.1* and the *TwinSAFE Loader* are permitted as engineering tools. Any deviations from these procedures or tools, particularly externally generated xml files for TwinSAFE import or externally generated automatic project creation procedures, are not covered by the certificate.

⚠ WARNING

Commissioning test

Before the EP2918-0032 can be used for the safety task, the user must carry out a commissioning test so that sensor and actuator wiring faults can be ruled out.

⚠ CAUTION

Follow the machinery directive!

The TwinSAFE components shall only be used in machines as defined in the machinery directive.

⚠ CAUTION

Ensure traceability!

The buyer has to ensure the traceability of the device via the serial number.

4.3 Technical data

The current certificates of all TwinSAFE products with the underlying standards and directives can be found at <https://www.beckhoff.com/en-en/support/download-finder/certificates-approvals/>.

Product designation	EP2918-0032 and EP2918-2232
Fieldbus	EtherCAT
Number of outputs	8
Connection of the outputs	M12
Status display	8 (one green LED per output), 5 diagnostic LEDs, 2 LEDs for Us/Up, 2 LEDs for EtherCAT Link/Act
Response time (read input/write to E-bus)	typical: 4 ms (in default setting without local TwinSAFE logic), maximum: see fault reaction time
Watchdog time	adjustable from 2 ms to 60 s
Fault reaction time	≤ watchdog time
Cable length between actuator and EtherCAT Box	Unshielded: max. 100 m (0.75 or 1 mm ²) Shielded: max. 100 m (0.75 or 1 mm ²)
Safe outputs	max. 2.0 A (at 24 V _{DC}) per channel Diagnostic thresholds: > 4.7 V -> high signal is detected < 1.0 V -> low signal is detected
Outputs (functional)	Functional overcurrent switch-off of the output driver: typically between 2.9 A and 6.3 A (This overcurrent switch-off is implemented purely functionally and cannot be loaded from a safety aspect.)
Input process image	6 bytes (via FSoE if using the default project)
Output process image	7 bytes (via FSoE if using the default project)
EP2918 supply voltage	24 V _{DC} (-15% / +20%)
Current consumption U _s (8 output channels switched)	8 channels occupied: typically 120 mA 0 channels occupied: typically 80 mA (provide a 4 A fuse)
Current consumption U _p (8 output channels switched, plus load current)	8 channels occupied: approx. 70 mA 0 channels occupied: approx. 20 mA (provide a 16 A fuse)
Power loss of the EtherCAT Box	typically 4.9 watts
Electrical isolation (between the channels)	no
Electrical isolation (between the channels and EtherCAT)	yes
Insulation voltage (between the channels and EtherCAT, under common operating conditions)	Insulation tested with 500 V _{DC}
Dimensions (W x H x D)	60 (+0.5) mm x 150 (+0.5) mm x 26.5 mm
Housing material	PBT+PET (Valox 855) Flame Class: V-0
Sealing compound	Polyurethane PU552L Flame Class: V-0
Weight	approx. 470 g
Permissible ambient temperature (operation)	-25 °C to +60 °C
Permissible ambient temperature (transport/storage)	-40 °C to +85 °C
Permissible air pressure (operation/storage/transport)	750 hPa to 1100 hPa (this is equivalent to an altitude of approx. -690 m to 2450 m above sea level assuming an international standard atmosphere)
Inadmissible operating conditions	TwinSAFE EtherCAT Boxes must not be used under the following conditions: <ul style="list-style-type: none"> • under the influence of ionizing radiation (exceeding the natural background radiation) • in corrosive environments
EMC tests according to	EN 61326-3-1:2017 (SIL 3) IEC 61131-2:2017 Chapter 6.2 and 7 (Zone B)
Vibration resistance	conforms to EN 60068-2-6 5 Hz ≤ f < 8.4 Hz (3.5 mm peak) 8.4 Hz ≤ f < 150 Hz (10 m/s ² peak)
Shock resistance	conforms to EN 60068-2-27 15 g with pulse duration 11 ms in all three axes
Protection rating (when screwed together)	IP67 (according to EN 60529)

Product designation	EP2918-0032 and EP2918-2232
Correct installation position	variable
Approvals	CE, TÜV SÜD

Derating table for altitudes above 2000 m

The derating table (table 8) from the IEC 61131-2:2017 standard can be referred to for the use of the TwinSAFE components above the specified maximum altitude.

Altitude in m	Derating factor for the temperature ¹
0 to 2000 ²	1.0
3000	0.9
4000	0.8
5000	0.7

Note: Linear interpolation is permissible between the altitudes

¹) Ambient temperature of the device at an altitude of 2000 m

²) The air pressure and air density increase as the altitude decreases. Therefore the derating factor for 0 to 2000 m (1.0) is used for altitudes below sea level.

Calculation example

In the following example the calculation is performed for a TwinSAFE component at an operating altitude of 4000 m.

Permissible ambient temperature up to 2000 m above sea level = 55 °C

Permissible ambient temperature up to 4000 m above sea level = 55 °C * 0.8 = 44 °C

⚠ CAUTION

Compliance with the temperature limits

The TwinSAFE component has a maximum internal temperature at which a switch-off takes place. This is designed for the maximum permissible ambient temperature. If the derating factor for the temperature for higher altitudes is used, the user is solely responsible for ensuring that the calculated maximum ambient temperature is complied with.

4.4 Safety parameters

Key data	EP2918-0032 and EP2918-2232
Lifetime [a]	20
Proof test interval [a]	not required ¹
PFH _D	4.16E-09
PFD	2.00E-05
MTTF _D	high
DC	high
Performance level	PL e
Category	4
HFT	1
Classification element ²	Type B

¹) Special proof tests are not required during the entire service life of the EtherCAT Box.

²) Classification according to EN 61508-2:2010 (see chapter 7.4.4.1.2 and 7.4.4.1.3)

The EtherCAT Box can be used for safety-related applications according to IEC 61508:2010 up to SIL3 and EN ISO 13849-1:2015 up to PL e (Cat 4).

Further information on calculating or estimating the $MTTF_D$ value from the PFH_D value can be found in the TwinSAFE Application Guide or in EN ISO 13849-1:2015, Table K.1.

In terms of safety-related parameters, the Safety-over-EtherCAT communication is already considered with 1% of SIL3 according to the protocol specification.

4.5 Safe output

The safe outputs are implemented as a single channel per module. It is essential to pay attention to the following note if two or more outputs run in a common sheathed cable.

⚠ DANGER

Clocked signals inside a sheathed cable

If clocked signals from different modules are used inside a single sheathed cable, then a module error such as a cross-circuit or external power supply must lead to the switch-off of all of these modules. This is achieved by setting the *Module Fault Link active* parameter for all modules involved. This parameter is set to TRUE by default.

4.6 Dimensions

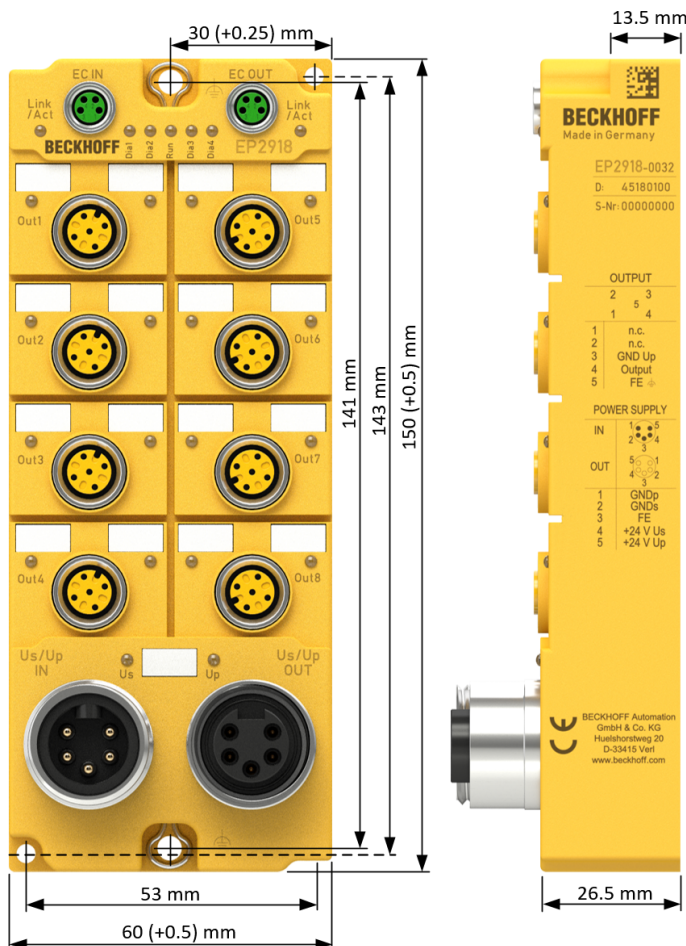

Fig. 3: Dimensions

The EtherCAT Box has the following dimensions:

Width	60.0 (+0.5) mm
Height	150.0 (+0.5) mm
Depth	26.5 mm

When fully wired, the connected cables increase the total depth of the module.

5 Operation

5.1 Environmental conditions

Please ensure that the TwinSAFE Boxes are only transported, stored and operated under the specified conditions (see technical data)!

WARNING

Risk of injury!

The TwinSAFE EtherCAT boxes must not be used under the following conditions.

- under the influence of ionizing radiation (that exceeds the level of the natural environmental radiation)
- in corrosive environments

NOTE

Electromagnetic compatibility

The TwinSAFE components comply with the current standards on electromagnetic compatibility with regard to spurious radiation and immunity to interference in particular.

However, in cases where devices such as mobile phones, radio equipment, transmitters or high-frequency systems that exceed the interference emissions limits specified in the standards are operated near TwinSAFE components, the function of the TwinSAFE components may be impaired.

5.2 Installation

5.2.1 Fixing

NOTE

Protect connectors against soiling!

Protect all connections from contamination during installation and operation of the modules! Protection class IP67 is only guaranteed if all cables and plug connectors are connected, and unused connections are protected with the appropriate cover plugs!
Connector sets see catalog.

- Modules with narrow housing are installed with two M3 screws.
- Modules with wide housing are installed with two M3 screws in the mounting holes in the corners or two M4 screws in the central fastening holes (see also chapter Power connection and grounding).
- The bolts must be longer than 15 mm. The fastening holes in the modules have no thread.
- Note when mounting that the overall height is increased further by the fieldbus connections.

5.2.2 Connection

5.2.2.1 Nut torque for connectors

M8 connector

We recommend fastening the M8 connector with a torque of **0.4 Nm**. A max. torque of **0.5 Nm** is also permissible if using a torque screwdriver (Beckhoff article ZB8800).

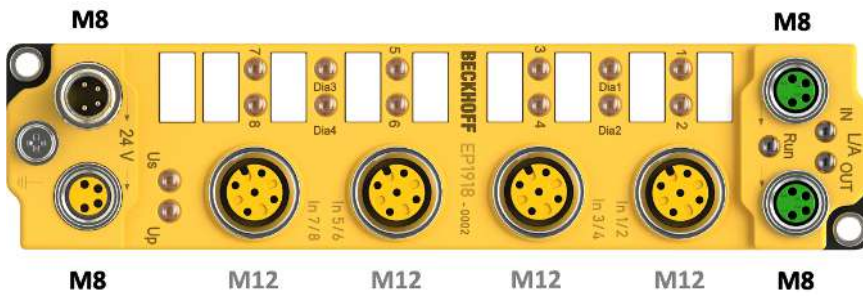

Fig. 4: EtherCAT Box with M8 plug connectors

M12 connector

We recommend fastening the M12 connector with a torque of **0.6 Nm**.

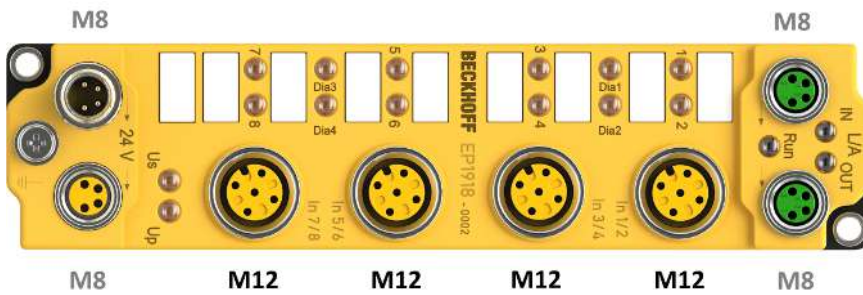

Fig. 5: EtherCAT Box with M8 and M12 connectors

7/8" plug connectors

We recommend fastening the 7/8" plug connectors with a torque of **1.5 Nm**.



Fig. 6: 7/8" plug connectors

Torque wrench



Fig. 7: Torque wrench ZB8801

NOTE

Ensure the proper torque is used

Use torque wrenches available from Beckhoff to tighten the connectors (see accessories)!

5.2.2.2 EtherCAT connection

The EtherCAT Box (EPxxxx) has two M8 connectors marked **green** for the incoming and outgoing EtherCAT connection.



Fig. 8: EtherCAT connection 30 mm housing M8

Connection

There are various different standards for the assignment and colors of connectors and cables for EtherCAT.

EtherCAT		Connector	Cable		Standard
Signal	Description	M8	ZB9010, ZB9020, ZK1090-6292	ZB903x, ZK1090-31xx	TIA-568B
Tx +	Transmit Data+	Pin 1	yellow ¹	orange/white ²	white/orange
Tx -	Transmit Data-	Pin 4	orange ¹	orange ²	orange
Rx +	Receive Data+	Pin 2	white ¹	blue/white ²	white/green
Rx -	Receive Data-	Pin 3	blue ¹	blue ²	green
Shield	Shield	Housing	Shield	Shield	Shield

¹) Core colors according to EN 61918

²) Core colors

5.2.2.3 EtherCAT cables

For connecting EtherCAT devices only Ethernet cables that meet the requirements of at least **category 5 (CAT5) according to EN 50173 or ISO/IEC 11801** should be used.

● Wiring recommendations

i Detailed recommendations for EtherCAT wiring can be found in the documentation "Design recommendations for EtherCAT/Ethernet infrastructure", which is available for download from www.Beckhoff.de.

EtherCAT uses four cable wires for signal transmission. Due to automatic cable detection (auto-crossing) symmetric (1:1) or cross-over cables can be used between EtherCAT devices from BECKHOFF.

5.2.2.4 Power connection and grounding

This chapter provides basic information about the power supply and grounding of the TwinSAFE EtherCAT Box. In particular, please note that the *General information on connecting the functional earth* only serves as an example.

Supply voltages (power connection)

The supply and distribution of the supply voltages takes place via the connections:

- **Us/Up IN** for feeding in the supply voltages
- **Us/Up OUT** for forwarding the supply voltages.

Both connections have a 7/8" thread and are located to the left (Us/Up IN) and right (Us/Up OUT) of the TwinSAFE EtherCAT Box (see figure: *EP2918 - power connection*).

Information: An overview of pin assignment for the two connections can be found later in this chapter.

General information for connecting the functional earth

The grounding lugs of the EP2918 are internally connected to the safe outputs (pin 5 of the M12 connections).

To provide functional earthing  , if possible the connection should:

- have a large surface
- have low resistance and
- be permanent.

In order to establish a permanent connection, all operating states of the machine, such as vibrations, must be taken into account.

The connection can be established using the following two methods:

1. via a bolted connection from the TwinSAFE EtherCAT Box to the machine bed
2. through a ring terminal (hole dia. 4.3 mm) with cable connection to the functional earth

A grounding lug is available at the upper and lower mounting points (hole dia. 5 mm for M4 thread) on the housing.

NOTE	
	<p>Connecting the functional earth</p> <p>The functional earth connection should have low resistance and a large surface.</p>



Power connection

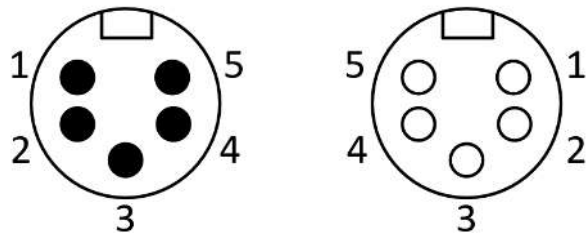

7/8-inch connector pin assignment

Contact	Voltage
1	GND Up
2	GND Us
3	Connecting the functional earth 
4	Control voltage Us, +24 V _{DC} (provide a 4 A fuse)
5	Peripheral voltage Up, +24 V _{DC} (provide a 16 A fuse)

The contacts of the 7/8" plug connectors can conduct a maximum current of 16 A.

Two LEDs indicate the status of the supply voltages.

NOTE**Do not confuse the power port with EtherCAT port!**

Never connect the power cables (M8, 24 V_{DC}) to the green-marked EtherCAT sockets of the EtherCAT Box modules. This can cause the destruction of the modules!

Control voltage Us

The fieldbus and the processor logic are supplied from the 24 V_{DC} control voltage Us. The control voltage is electrically isolated from the fieldbus circuitry.

Peripheral voltage Up

The peripheral voltage Up supplies the digital safe outputs.

Redirection of the supply voltages

The power IN and OUT connections are bridged in the module. Hence, the supply voltages Us and Up can be passed from EtherCAT Box to EtherCAT Box in a simple manner.

⚠ CAUTION**Note the maximum current!**

Also ensure when forwarding the supply voltages Us and Up that the maximum permissible current of 16 A for each contact of the 7/8" plug connector is not exceeded!

5.2.2.5 Signal connection for outputs

The EtherCAT Box has 8 fail-safe outputs with a maximum output current of 2.0 A each (at 24 V_{DC}).

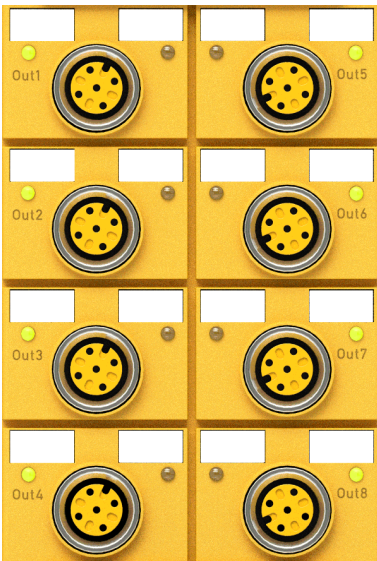

Fig. 9: Safe outputs 1 to 8

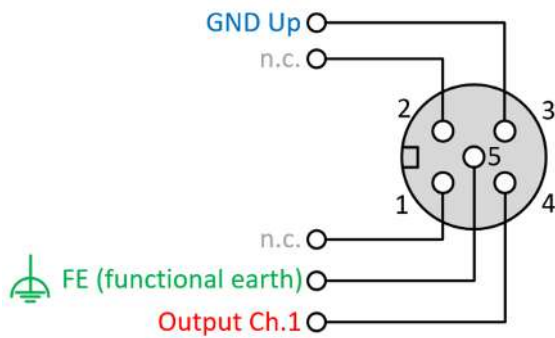

Fig. 10: PinOut safe output

M12 connection	Contact	Channel	Signal
1	1	-	not connected
	2	-	not connected
	3	1	GND Up
	4	-	Output 1
	5	-	Functional earth FE
2	1	-	not connected
	2	-	not connected
	3	2	GND Up
	4	-	Output 2
	5	-	Functional earth FE
3	1	-	not connected
	2	-	not connected
	3	3	GND Up
	4	-	Output 3
	5	-	Functional earth FE
4	1	-	not connected
	2	-	not connected
	3	4	GND Up
	4	-	Output 4
	5	-	Functional earth FE
5	1	-	not connected
	2	-	not connected

M12 connection	Contact	Channel	Signal
	3	5	GND Up
	4		Output 5
	5	-	Functional earth FE
6	1	-	not connected
	2	-	not connected
	3	6	GND Up
	4		Output 6
	5	-	Functional earth FE
7	1	-	not connected
	2	-	not connected
	3	7	GND Up
	4		Output 7
	5	-	Functional earth FE
8	1	-	not connected
	2	-	not connected
	3	8	GND Up
	4		Output 8
	5	-	Functional earth FE



Functional earth

The functional earth on pin 5 of the M12 connections of the outputs is internally connected to the grounding lugs of the EtherCAT Box.

5.2.2.6 Overvoltage protection

If protection against overvoltage is necessary in your system, provide a protective circuit (surge filter) against overvoltage for the power supply to the EtherCAT Box.

5.2.3 Temperature measurement

The temperature measurement of the TwinSAFE EtherCAT Box consists of a single EtherCAT Box that is wired with corresponding supply and communication cables. The inputs and/or outputs of the EtherCAT Box are switched on for the test.

NOTE

External heat sources / radiant heat / impaired convection

The maximum permissible ambient temperature of 60°C was checked with the example configuration described above. Impaired convection or an unfavorable location near heat sources may have a negative effect on the internal heating of the TwinSAFE components.

The key parameter is always the maximum permitted internally measured temperature of 95°C, above which the TwinSAFE components switch to safe state and report an error. The internal temperature can be read from the TwinSAFE components via CoE.

5.2.4 Signal cables

Permitted cable length

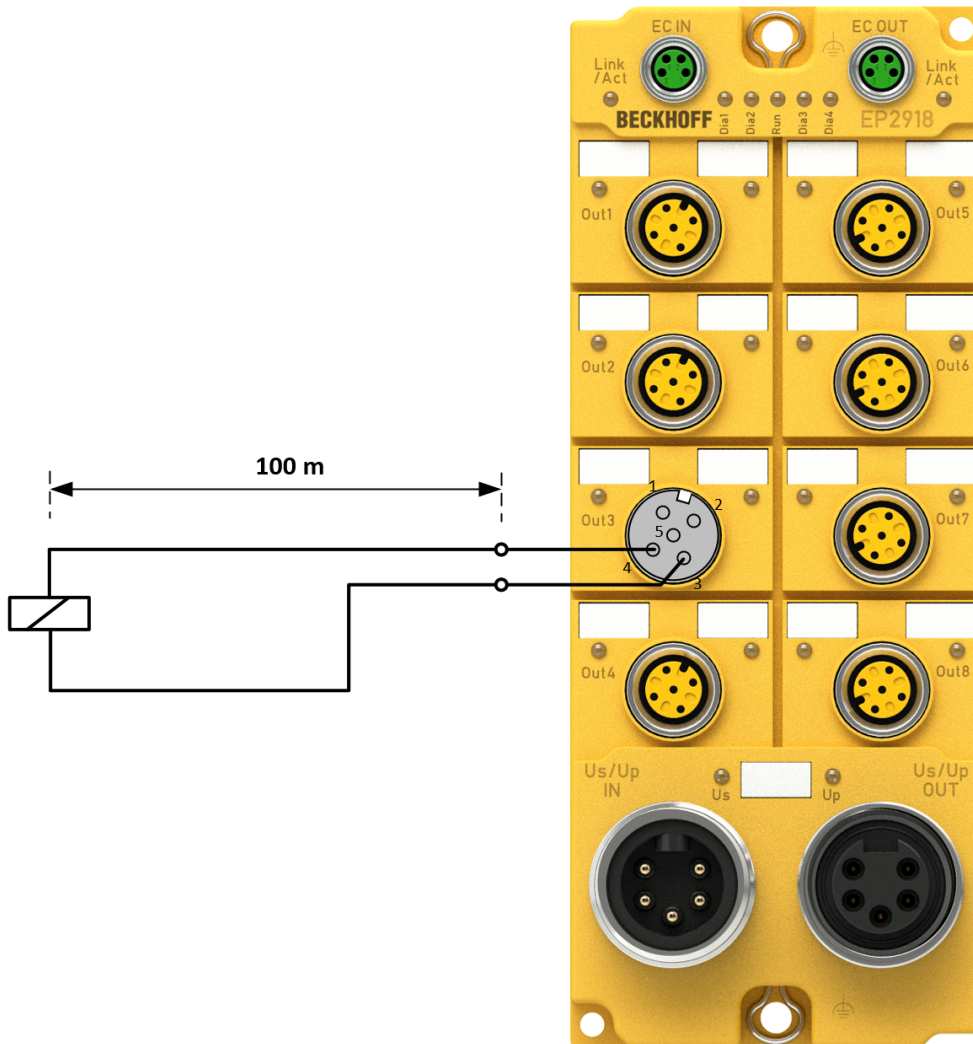

Fig. 11: Signal lines

When connecting a single switching contact via its own continuous cabling (or via a sheathed cable), the maximum permitted cable length with test pulses activated is 100 meters.

The use of contact points, connectors or additional switching contacts in the cabling reduces the maximum propagation.

Cable routing

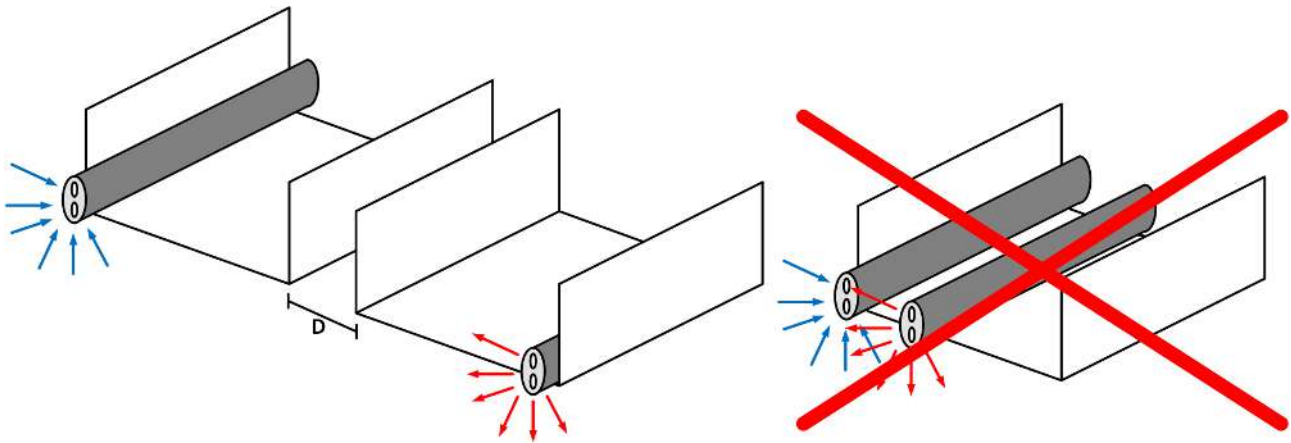

Fig. 12: Cable routing

NOTE**Route the signal cable separately**

The signal cable must be routed separately from potential sources of interference, such as motor supply cables, 230 V_{AC} power cables etc.!

Interference caused by cables routed in parallel can influence the signal form of the test pulses and thus cause diagnostic messages (e.g. sensor errors or OpenLoad errors).

D: Distance between the cable ducts should be as large as possible

blue arrows: signal line

red arrows: potential source of interference

The common routing of signals together with other clocked signals in a common cable also reduces the maximum propagation, since crosstalk of the signals can occur over long cable lengths and cause diagnostic messages.

5.3 Configuration of the EtherCAT Box in TwinCAT

● Identical configuration

The configuration of the EtherCAT Box in TwinCAT is identical for the variant EP2918-2232.

⚠ CAUTION

Do not change CoE objects!

Do not change any of the CoE objects in the TwinSAFE terminals. Any modifications (e.g. via TwinCAT) of the CoE objects will permanently set the terminals to the Fail-Stop state or lead to unexpected behavior of the terminals!

5.3.1 Adding an EtherCAT device

See TwinCAT automation software documentation.

5.3.2 Inserting an EP2918

An EP2918 is inserted in exactly the same way as any other Beckhoff EtherCAT Box. Open the *TwinSAFE Fieldbus Boxes* item in the list and select the EP2918.

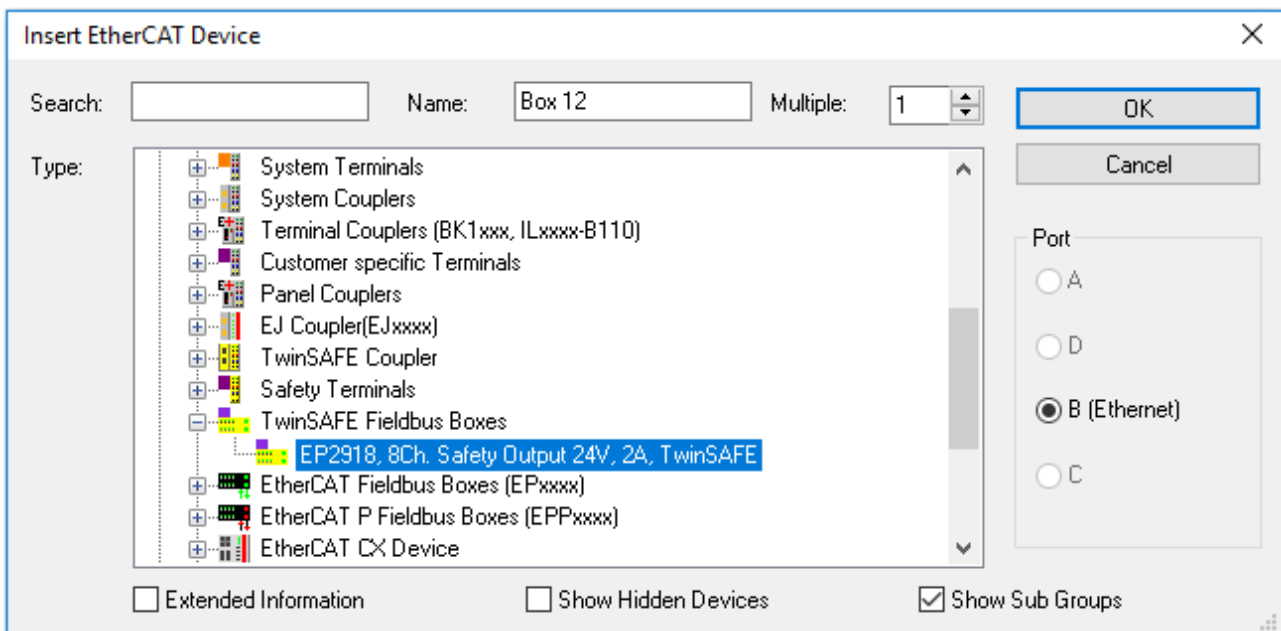

Fig. 13: Inserting an EP2918

5.3.3 EP2918-0032: using the integrated TwinSAFE Logic functions

On delivery, the EP2918 behaves like a safe TwinSAFE I/O slave, which can be used as an alias device within a TwinSAFE Logic, e.g. EL6910.

Alternatively, the local logic function of the EP2918 can be used. To this end please create a TwinSAFE project in the Safety Editor and select the EP2918 as the target system. Further information on creating a project can be found in the EL6910 documentation and the description of the function blocks under <http://www.beckhoff.de/german/download/twinsafe.htm>.

In order to be able to use the EP2918 again as a safe TwinSAFE I/O slave, please delete the logic, the mapping and the parameter data on the EtherCAT Box and switch the voltage off and on again.

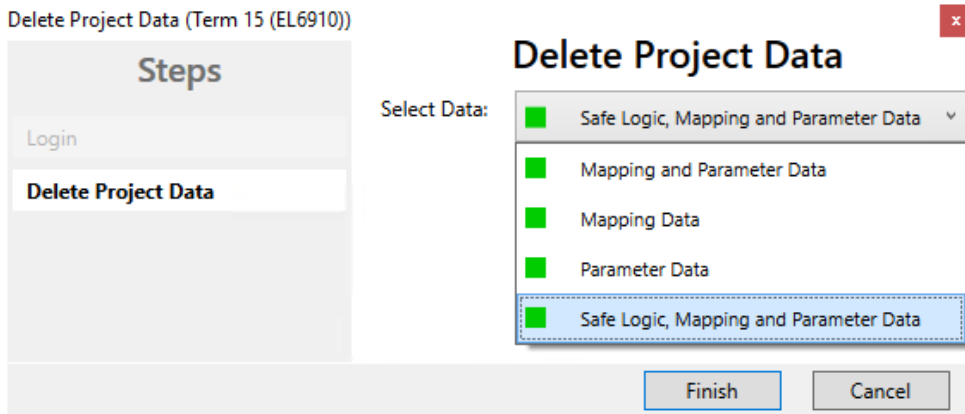

Fig. 14: EP2918 - Delete Project Data

5.3.3.1 Project design limits of the EP2918

i **Project design limits**

The maximum project design size of the EP2918 is limited by the available memory. This is managed dynamically. The values specified in the following table are therefore only guide values and may differ from the actual values, depending on the safety project.

NOTE

Execution time of the logic function

Compared to the EL6910 with an identical logic program, the execution time will be typically longer as the safe I/O signals have to be processed in addition. Accordingly this also affects the processing of the I/O signals, as they can only be evaluated less frequently as the size of the project increases.

Process image size	max. 1486 bytes per data direction (Max. memory size 0x1E00 for 3 buffers, i.e. with the same size of input and output process data a maximum size of 1280 bytes per data direction results. Only even-numbered start addresses are possible, therefore padding bytes may have to be included.)
TwinSAFE connections	maximum 212 (Maximum 255 CRCs in total - 1 CRC is required for a TwinSAFE connection with 1 or 2 bytes of safe data.)
Safe data per TwinSAFE connection	maximum 126 bytes (telegram length 255 bytes)
TwinSAFE function blocks	maximum 512 (For using ESTOP function blocks with complete input and output mapping. Other function blocks may lead to a lower maximum number.)
TwinSAFE groups	maximum 128
TwinSAFE user	maximum 40
Standard PLC inputs	dynamic (memory-dependent), max. 1483 bytes
Standard PLC outputs	dynamic (memory-dependent), max. 1483 bytes

NOTE

Project planning

TwinCAT 3.1 Build 4022.28 or later is required for the use of the internal logic functions. If the EP2918 is used as a TwinSAFE slave with the default project, at least an EL6910, EK1960 or newer logic components are required as a TwinSAFE master.

5.3.4 Address settings on the TwinSAFE EtherCAT Box

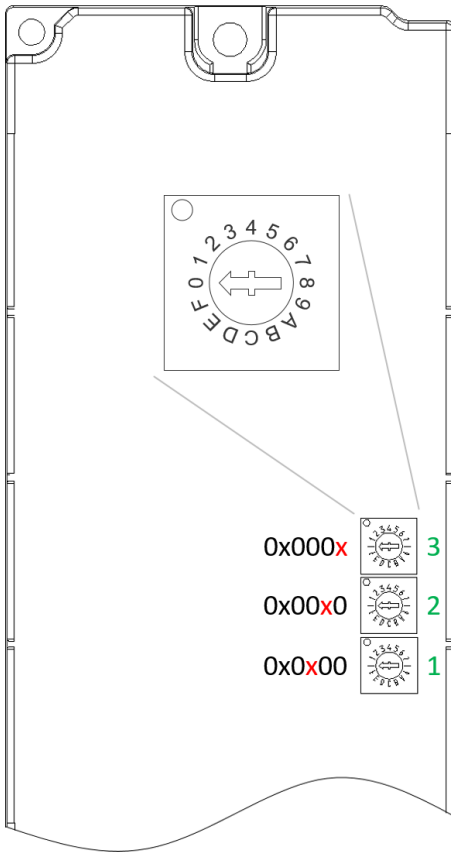

Fig. 15: EtherCAT Box - Rotary switches on the underside

The TwinSAFE address of the Box must be set using the three rotary switches on the underside of the TwinSAFE-EP Box. TwinSAFE addresses between 1 and 4095 are available.

Rotary switch			Address
1 (bottom)	2 (center)	3 (top)	
0	0	1	1
0	0	2	2
0	0	3	3
...
0	0	F	15
0	1	0	16
0	1	1	17
...
0	F	F	255
1	0	0	256
1	0	1	257
...
F	F	F	4095

⚠ WARNING

TwinSAFE address

Each TwinSAFE address must be unique within a network!
The address 0 is not a valid address.

5.3.5 Alias devices

The communication between the safety logic and the I/O level is realized via an alias level. At this alias level (subnode *Alias Devices*) corresponding alias devices are created for all safe inputs and outputs, and also for standard signal types. For the safe inputs and outputs, this can be done automatically via the I/O configuration.

The connection- and device-specific parameters are set via the alias devices.

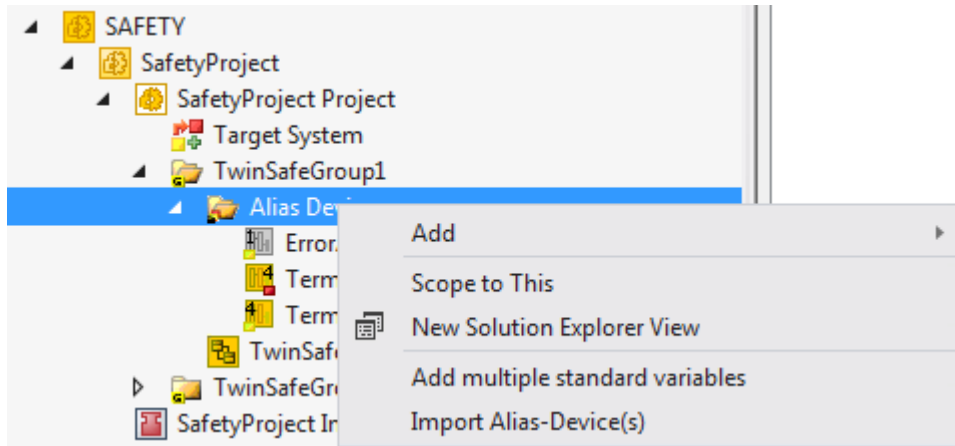

Fig. 16: Starting the automatic import from the I/O configuration

If the automatic import is started from the I/O configuration, a selection dialog opens, in which the individual terminals to be imported can be selected.

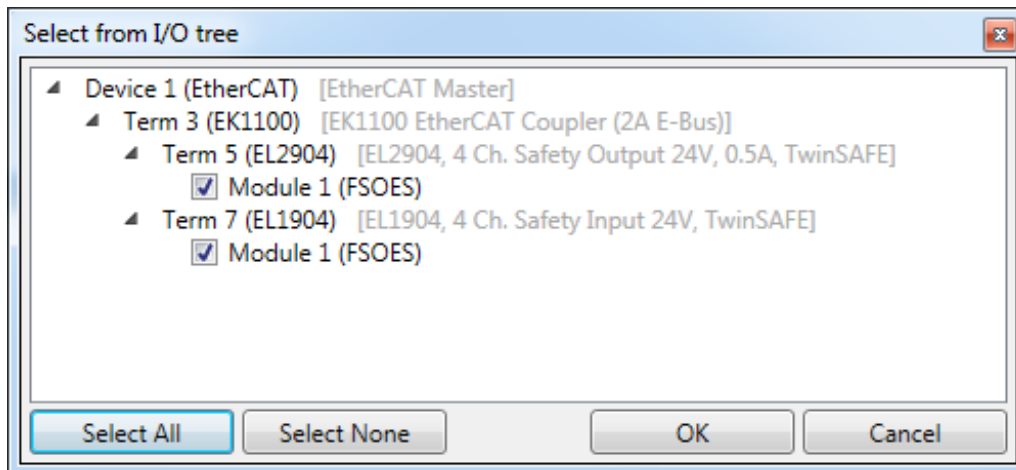

Fig. 17: Selection from the I/O tree

The alias devices are created in the safety project when the dialog is closed via OK.

Alternatively, the user can create the alias devices individually. To this end select *Add* and *New item* from the context menu, followed by the required device.

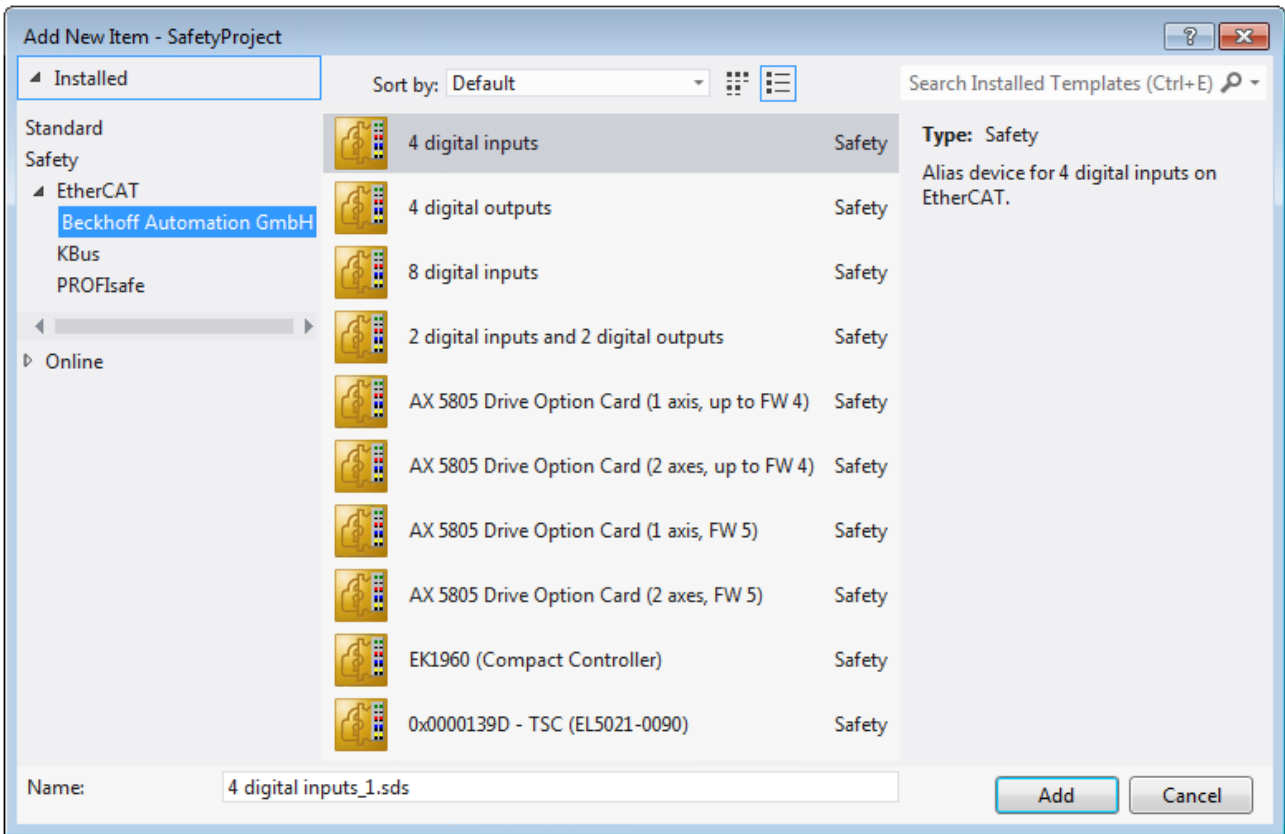

Fig. 18: Creating alias devices by the user

5.3.6 EP2918 parameters

After creating the alias device, it can be parameterized according to the user specifications. The FSoE address is set under the *Linking* tab, and the link to the physical device is created.

Linking	Connection	Safety Parameters	Process Image	Internal Safety Parameters	Internal Process Image	Internal Direct Mappings
FSoE Address:	15		External Safe Address:			
Linking Mode:	Automatic					
Physical Device:	TIID^Device 2 (EtherCAT)^Box 11 (EP2918-0032)^Module 1 (FSoE)					
Dip Switch:	n.a.					
Input: Full Name:	TIID^Device 2 (EtherCAT)^Term 9 (AX8620-0000-0102)^Drive 10					
Linked to:	TIID^Device 2 (EtherCAT)^Box 11 (EP2918-0032)^Module 1 (FSoE)					
Output: Full Name:	TIID^Device 2 (EtherCAT)^Term 9 (AX8620-0000-0102)^Drive 10					
Linked to:	TIID^Device 2 (EtherCAT)^Box 11 (EP2918-0032)^Module 1 (FSoE)					
Name:	Message_12					

Fig. 19: EP2918 – Linking tab

Name	Description
FSoE address	Parameterized FSoE address (to be set by the user)
External safe address	currently not supported
Linking mode	<ul style="list-style-type: none"> • Automatic (automatic linking to the physical device) • Manual (manual linking, e.g. to network variables) • Local (signals are used in the local logic)
Physical device	Link to the TwinSAFE component within the TwinCAT solution
DIP switch	DIP or rotary switch address read from the TwinSAFE component
Input: Full name	In manual mode: Display of the variables below the TwinSAFE Logic, e.g. EL6910
Input: Linked to:	In manual mode: Display of the linked variables
Output: Full name	In manual mode: Display of the variables below the TwinSAFE Logic, e.g. EL6910
Output: Linked to	In manual mode: Display of the linked variables
Name	In manual mode: Name of the TwinSAFE message below the TwinSAFE Logic and for the info data

Under the *Connection* tab you can make further settings, e.g. the mapping of the info data or the behavior in case of a module error.

Fig. 20: EP2918 - *Connection* tab

Name	Description
Conn. no.	Connection number (issued by the system)
Conn. Id	Connection ID: Pre-allocated by system, can be changed by the user. The connection ID must be unique within the TwinCAT project.
Mode	<ul style="list-style-type: none"> • FSoE master (the logic is the master for this alias device) • FSoE slave (the logic is a slave for this alias device)
Watchdog	Setting the watchdog time in ms for this connection. This setting directly affects the fault response time.
Module Fault is ComError	If the checkbox is checked, module error also triggers a ComError, which switches the TwinSAFE group where the connection was created to the error state.
Com ERR Ack	For each connection, an additional error acknowledge can be configured. In this case, the connection must also be acknowledged, in addition to the Err Ack for the respective group.
Map state	The connection state is placed in the cyclic process data.
Map diag	The connection diagnostics is placed in the cyclic process data.
Map inputs	The safe input information of the connection is placed in the cyclic process data.
Map outputs	The safe output information of the connection is placed in the cyclic process data.

The *Safety Parameters* tab contains the parameters of the EP2918 to be set. The outputs are parameterized via the objects 0x8000 etc.

Index	Name	Value	Unit
8000:0	FSOUT Module 1 Settings Common	>7<	
8000:01	ModuloDiagTestPulse	0x00 (0)	
8000:02	MultiplierDiagTestPulse	0x01 (1)	
8000:03	Standard Outputs active	FALSE (0)	
8000:04	Diag TestPulse active	TRUE (1)	
8000:07	Module Fault Link active	TRUE (1)	
8010:0	FSOUT Module 2 Settings Common	>7<	
8010:01	ModuloDiagTestPulse	0x00 (0)	
8010:02	MultiplierDiagTestPulse	0x01 (1)	
8010:03	Standard Outputs active	FALSE (0)	
8010:04	Diag TestPulse active	TRUE (1)	
8010:07	Module Fault Link active	TRUE (1)	
8020:0	FSOUT Module 3 Settings Common	>7<	
8030:0	FSOUT Module 4 Settings Common	>7<	
8040:0	FSOUT Module 5 Settings Common	>7<	
8050:0	FSOUT Module 6 Settings Common	>7<	
8060:0	FSOUT Module 7 Settings Common	>7<	
8070:0	FSOUT Module 8 Settings Common	>7<	

Edit

Fig. 21: EP2918 - Parameters

Index	Name	Default value/ unit	Description
8000:01	ModuloDiagTestPulse (FSOUT module 1)	0x00 / integer	Modulo value for the frequency of the generation of a test pulse. 0 -> every time 1 -> every second time and so on
8000:02	MultiplierDiagTestPulse (FSOUT module 1)	0x01 / integer	Length of the test pulse in multiples of 400 µs
8000:03	Standard outputs active (FSOUT module 1)	FALSE / Boolean	Activation of the logical AND operator of the safe and standard outputs of the module
8000:04	Diag test pulse active (FSOUT module 1)	TRUE / Boolean	Activation of test pulses for the corresponding output module
8000:07	Module Fault Link active (FSOUT Module 1)	TRUE / Boolean	If a module error occurs in this module, a module error is also set for all other output modules of this TwinSAFE component for which this parameter is also set to TRUE.
8010:01-07	Parameters for FSOUT module 2	see module 1	see module 1
8020:01-07	Parameters for FSOUT module 3	see module 1	see module 1
8030:01-07	Parameters for FSOUT module 4	see module 1	see module 1
8040:01-07	Parameters for FSOUT module 5	see module 1	see module 1
8050:01-07	Parameters for FSOUT module 6	see module 1	see module 1
8060:01-07	Parameters for FSOUT module 7	see module 1	see module 1
8070:01-07	Parameters for FSOUT module 8	see module 1	see module 1

5.3.7 Process image of the EP2918

The process image of EP2918 consists of 6 bytes of input data and 7 bytes of output data. The 6-byte telegram contains 1 byte of safe data, while the 7-byte telegram contains 2 bytes of safe data.

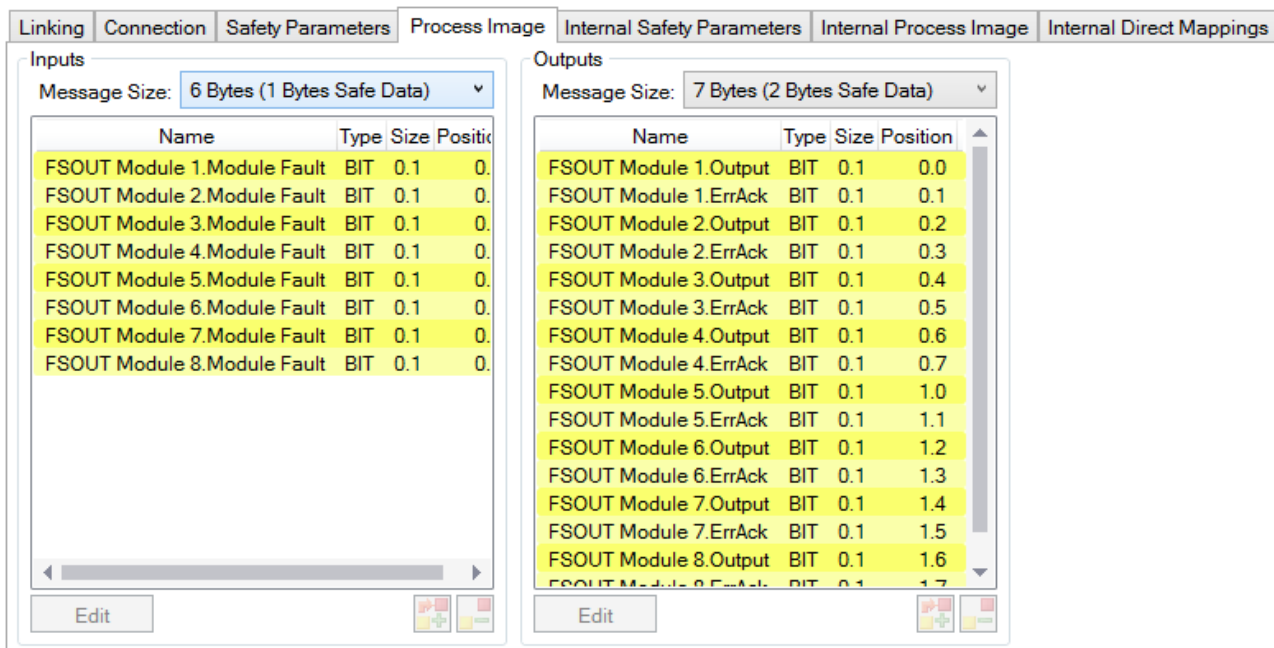

Fig. 22: EP2918 Process image

The assignment of the individual signals in the safe data is listed in the following table.

Name	Process image	Bit position	Description
FSOUT module 1. module fault	IN	0.0	Module error information for safe output 1
FSOUT module 2. module fault	IN	0.1	Module error information for safe output 2
FSOUT module 3. module fault	IN	0.2	Module error information for safe output 3
FSOUT module 4. module fault	IN	0.3	Module error information for safe output 4
FSOUT module 5. module fault	IN	0.4	Module error information for safe output 5
FSOUT module 6. module fault	IN	0.5	Module error information for safe output 6
FSOUT module 7. module fault	IN	0.6	Module error information for safe output 7
FSOUT module 8. module fault	IN	0.7	Module error information for safe output 8
FSOUT Module1.Output	OUT	0.0	Safe output 1
FSOUT Module1.ErrAck	OUT	0.1	Error acknowledge for safe output module 1
FSOUT Module2.Output	OUT	0.2	Safe output 2
FSOUT Module2.ErrAck	OUT	0.3	Error acknowledge for safe output module 2
FSOUT Module3.Output	OUT	0.4	Safe output 3
FSOUT Module3.ErrAck	OUT	0.5	Error acknowledge for safe output module 3
FSOUT Module4.Output	OUT	0.6	Safe output 4
FSOUT Module4.ErrAck	OUT	0.7	Error acknowledge for safe output module 4
FSOUT Module5.Output	OUT	1.0	Safe output 5
FSOUT Module5.ErrAck	OUT	1.1	Error acknowledge for safe output module 5
FSOUT Module6.Output	OUT	1.2	Safe output 6
FSOUT Module6.ErrAck	OUT	1.3	Error acknowledge for safe output module 6
FSOUT Module7.Output	OUT	1.4	Safe output 7
FSOUT Module7.ErrAck	OUT	1.5	Error acknowledge for safe output module 7
FSOUT Module8.Output	OUT	1.6	Safe output 8
FSOUT Module8.ErrAck	OUT	1.7	Error acknowledge for safe output module 8

5.4 TwinSAFE reaction times

The TwinSAFE terminals form a modular safety system that exchanges safety-oriented data via the Safety-over-EtherCAT protocol. This chapter is intended to help you determine the system's reaction time from the change of signal at the sensor to the reaction at the actuator.

Typical response time

The typical response time is the time required for transferring a piece of information from the sensor to the actuator, when the whole system operates normally, without error.

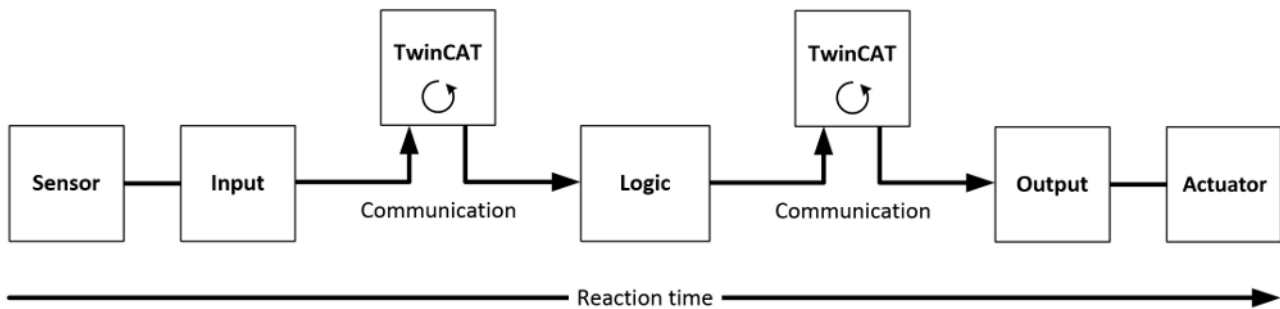

Fig. 23: Typical response time

Definition	Description
RT_{Sensor}	Response time of the sensor, until the signal is made available at the interface. Typically provided by the sensor manufacturer.
RT_{Input}	Response time of the safe input, e.g. EL1904 or EP1908. This time can be found in the technical data. In the case of the EL1904 it is 4 ms.
RT_{Comm}	Response time of the communication. This is typically 3 times the EtherCAT cycle time, since a new Safety-over-EtherCAT telegram has to be generated before new data can be sent. These times depend directly on the higher-level standard controller (cycle time of the PLC/NC).
RT_{Logic}	Response time of the logic terminal. This is the cycle time of the logic terminal and typically ranges from 500 μ s to 10 ms for the EL6900, depending on the size of the safety project. The actual cycle time can be read from the terminal.
RT_{Output}	Response time of the output terminal. This is typically between 2 and 3 ms.
$RT_{Actuator}$	Response time of the actuator. This information is typically provided by the actuator manufacturer
WD_{Comm}	Watchdog time of the communication

The typical response time is based on the following formula:

$$ReactionTime_{typ} = RT_{Sensor} + RT_{Input} + 3 * RT_{Comm} + RT_{Logic} + 3 * RT_{Comm} + RT_{Output} + RT_{Actuator}$$

with

$$ReactionTime_{typ} = 5ms + 4ms + 3 * 1ms + 10ms + 3 * 1ms + 3ms + 20ms = 48ms$$

Worst case response time

The worst-case response time is the maximum time required for switching off the actuator in the event of an error.

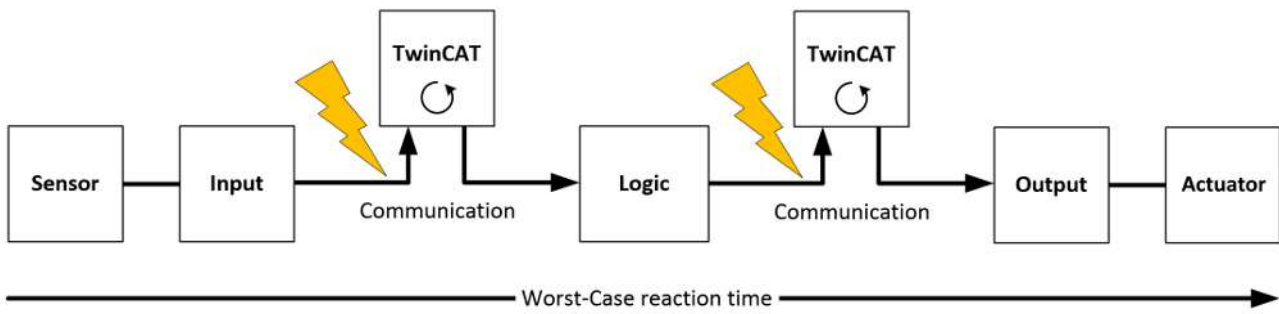

Fig. 24: Worst case response time

It is assumed that a signal change takes place at the sensor, and that this is passed to the input. A communication error occurs just at the moment when the signal is to be passed to the communication interface. This is detected by the logic once the watchdog time of the communication link has elapsed. This information should then be passed on to the output, resulting in a further communication error. This fault is detected at the output once the watchdog time has elapsed, resulting in shutdown.

This results in the following formula for the worst-case response time:

$$ReactionTime_{max} = WD_{Comm} + WD_{Comm} + RT_{Actuator}$$

with

$$ReactionTime_{max} = 2 * 15ms + 20ms = 50ms$$

5.5 Diagnostics

5.5.1 EtherCAT- Fieldbus LEDs

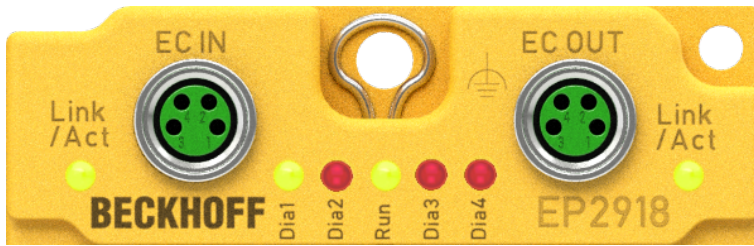

Fig. 25: EP2918 Diagnostic LEDs

LED displays

LED	Display	Meaning
IN Link/Act	off	no connection to the preceding EtherCAT module
	lit	LINK: connection to the preceding EtherCAT module
	flashes	ACT: communication with the preceding EtherCAT module
OUT Link/Act	off	no connection to the following EtherCAT module
	lit	LINK: connection to the following EtherCAT module
	flashes	ACT: Communication with the following EtherCAT module
Run	off	Status of the EtherCAT module is Init
	flashes quickly	Status of the EtherCAT module is pre-operational
	flashes slowly	Status of the EtherCAT module is safe-operational
	lit	Status of the EtherCAT module is operational

5.5.2 Status LEDs

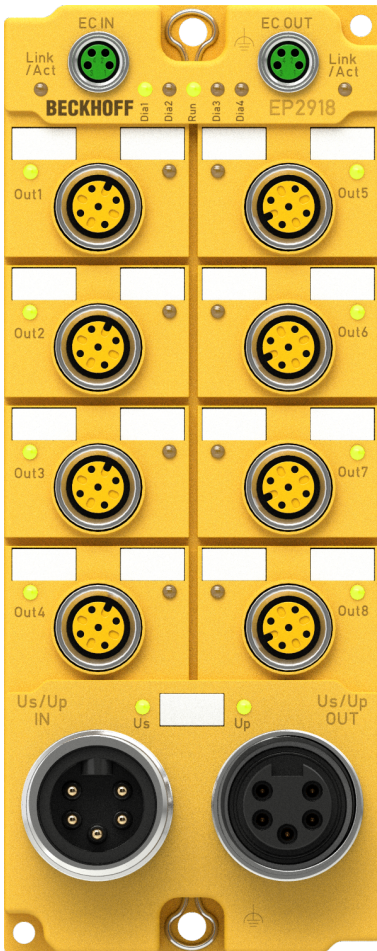

Fig. 26: EP2918 Status LEDs

LED	Display	Meaning
Out 1	on	Output 1 is connected
	off	Output 1 is not connected
Out 2	on	Output 2 is connected
	off	Output 2 is not connected
Out 3	on	Output 3 is connected
	off	Output 3 is not connected
Out 4	on	Output 4 is connected
	off	Output 4 is not connected
Out 5	on	Output 5 is connected
	off	Output 5 is not connected
Out 6	on	Output 6 is connected
	off	Output 6 is not connected
Out 7	on	Output 7 is connected
	off	Output 7 is not connected
Out 8	on	Output 8 is connected
	off	Output 8 is not connected
Us	on	Control voltage Us is available
	off	Control voltage Us is not available
Up	on	Peripheral voltage Up is present
	off	Peripheral voltage Up is not present

5.5.3 Diagnostic LEDs

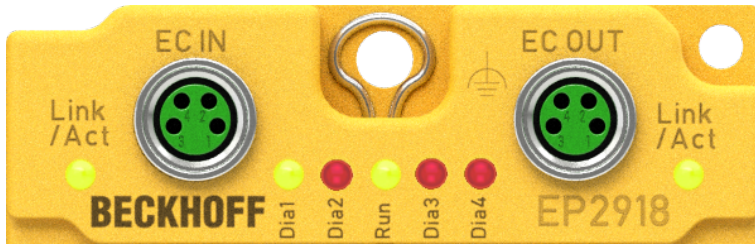

Fig. 27: EP2918 - Diagnostic LEDs

LED displays

LED	lit	flashes	flickering	off
Dia1 (green)	Environment variables, operating voltage and internal tests are in the valid range <ul style="list-style-type: none"> If Dia2 flashes, a logic error code applies 	-		Environment variables, operating voltage and internal tests are outside the valid range <ul style="list-style-type: none"> If Dia2 flashes, an environment error code applies
Dia2 (red)	Together with Dia3 and 4: Global shutdown ¹⁾ has occurred. (see diag history of the TwinSAFE components)	Logic or environment error code according to Dia1 and tables below is output	fault in a safe input or output module	Together with Dia3 and 4: Global fault ¹⁾ has occurred. (see diag history of the TwinSAFE components)
Dia3 (red)	Global fault or global shutdown on $\mu C1$ ¹⁾	-		No global fault or global shutdown on $\mu C1$ ¹⁾
Dia4 (red)	Global fault or global shutdown on $\mu C2$ ¹⁾	-		No global fault or global shutdown on $\mu C2$ ¹⁾

¹⁾ A global fault permanently disables the TwinSAFE component, so that it has to be replaced. A global shutdown temporarily disables the TwinSAFE component. The error can be reset by switching off and back on again.

Logic error codes of LED Dia2 (if LED Dia1 is lit)



Flashing Code	Description
1	Function block error in one of the TwinSAFE groups
2	Communication error in one of the TwinSAFE groups
3	Error combination: Function block and communication
4	General error in one of the TwinSAFE groups
5	Error combination: General and function block
6	Error combination: General and communication
7	Error combination: General, function block and communication

Environment error codes of LED Dia2 (if LED Dia1 is off)

Flashing Code	Description
1	Maximum supply voltage $\mu C1$ exceeded
2	Supply voltage $\mu C1$ below minimum value
3	Maximum supply voltage $\mu C2$ exceeded
4	Supply voltage $\mu C2$ below minimum value
5	Maximum internal temperature exceeded
6	Internal temperature below minimum value
7	Valid temperature difference between $\mu C1$ and $\mu C2$ exceeded

Flashing Code	Description
8	not used
9	not used
10	General error

5.5.4 Flash code display

LED	Display	Description
flashing		400 ms ON / 400 ms OFF 1 second pause between the flash codes
flickering		50 ms ON / 50 ms OFF

5.5.5 Diagnostic objects

⚠ CAUTION

Do not change CoE objects!

Do not make any modifications to the CoE objects in the TwinSAFE components! Any modifications (e.g. using TwinCAT) of the CoE objects will permanently set the TwinSAFE components to the Fail-Stop state.

Index F984_{hex}: Device Info Data C1

CoE object F984_{hex} currently displays internal temperature and voltage values for the TwinSAFE component.

Index	Name	Meaning	Flags	Default
F984:01	Voltage C2	Voltage μC2	RO	0 _{dec}
F984:02	Temperature C1	Temperature μC1	RO	0 _{dec}
F984:03	Firmware CRC C1	CRC of the firmware on μC1	RO	-
F984:04	Vendor data CRC C1	CRC of the vendor data on μC1	RO	-

Index F985_{hex}: Device Info Data C2

CoE object F985_{hex} currently displays internal temperature and voltage values for the TwinSAFE component.

Index	Name	Meaning	Flags	Default
F985:01	Voltage C1	Voltage μC1	RO	0 _{dec}
F985:02	Temperature C2	Temperature μC2	RO	0 _{dec}
F985:03	Firmware CRC C2	CRC of the firmware on μC2	RO	-
F985:04	Vendor data CRC C2	CRC of the vendor data on μC2	RO	-

i Diagnostics history

Any errors, which occur during operation of the TwinSAFE component, such as overtemperature or undervoltage, are entered in the diagnostics history with a corresponding timestamp.

Index F100_{hex}: FSLOGIC status

The CoE object F100_{hex} shows the current status of the TwinSAFE component.

Index	Name	Meaning	Flags	Default
F100:01	Safe Logic State	Status of the internal logic: 0: OFFLINE 1: RUN 3: SAFE 6: START	RO	0 _{bin}

Index	Name	Meaning	Flags	Default
		8: PREPARE 10: RESTORE 11: PROJECT-CRC-OK		
F100:02	Cycle Counter	Life cycle counter, which is incremented with each TwinSAFE logic cycle.	RO	0 _{bin}

The following table contains a description of all values of the index F100_{hex} SubIndex 01.

Index	Value	Description
F100:01	0: OFFLINE	In the OFFLINE state no TwinSAFE logic program is loaded. No TwinSAFE groups and no TwinSAFE connections are processed.
	1: RUN	In the RUN state all TwinSAFE groups and all TwinSAFE connections configured in the TwinSAFE logic program are processed.
	3: SAFE	The SAFE state is assumed from the RUN state when the TwinSAFE logic program is stopped. If the TwinSAFE logic program is restarted without a new TwinSAFE logic program having been transferred, the TwinSAFE logic should switch again from SAFE to RUN. All TwinSAFE groups should be initialized with the initial state STOPERROR, so that an error acknowledgement occurs before safe outputs are connected again. In the SAFE state no TwinSAFE groups and no TwinSAFE connections are processed.
	6: START	The START state is assumed if the TwinSAFE logic program is loaded but the standard communication channel (e.g. EtherCAT) is not yet in process data exchange or the process data lengths configured via the standard communication channel do not match the process data lengths calculated using the TwinSAFE logic program. The START state is also assumed when a user is logged in for the purpose of deleting the current TwinSAFE logic program or transferring the user list. In the START state no TwinSAFE groups and no TwinSAFE connections are processed.
	8: PREPARE	The PREPARE state is assumed at the transition from START to RUN or from SAFE to RUN. In the PREPARE state, the stored data read in from the FRAM is checked and then the RUN state is assumed. If an error is detected during checking of the stored data, all TwinSAFE groups assume the initial state STOPERROR. If no error is detected during checking of the stored data, all TwinSAFE groups assume the initial state STOP.
	10: RESTORE	In the RESTORE state the loaded TwinSAFE restore program is to be checked by comparing its project CRC with the project CRCs read in via the corresponding TwinSAFE connections. In the RESTORE state all TwinSAFE connections configured in the TwinSAFE Restore program are processed.
	11: PROJECT-CRC-OK	The PROJECT-CRC-OK state is assumed once the project CRC of the loaded TwinSAFE restore program has been successfully checked via the TwinSAFE connections. In the PROJECT-CRC-OK state no TwinSAFE groups and no TwinSAFE connections are processed.

This CoE object is additionally copied into the cyclic process image of the TwinSAFE component. From there, this information can be directly linked into the PLC.

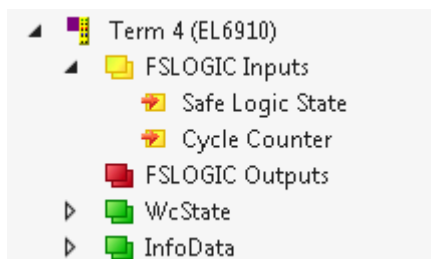

Fig. 28: Diagnostic object - FSLOGIC Status (F100_{hex}) in the process image of the TwinSAFE component

5.5.6 Cycle time of the safety project

The execution time of the TwinSAFE logic can be read from the CoE objects listed below. To determine the cycle time, it has to be multiplied with 1.25, because this is the factor used internally for generating a delay time before the next cycle.

Index FEAO_{hex}: CTRL Diag Data

Index	Name	Meaning	Flags	Default
FEA0:09	Actual Safety Control Task Execution Time	Current execution time of the TwinSAFE logic with a logic state of 1 (RUN) Cycle time = 1.25 * value (average value of 64 cycles)	RO	0 _{hex}
FEA0:0A	Min Safety Control Task Execution Time	Minimum execution time of the TwinSAFE logic with a logic state of 1 (RUN) Cycle time = 1.25 * value	RO	0 _{hex}
FEA0:0B	Max Safety Control Task Execution Time	Maximum execution time of the TwinSAFE logic with a logic state of 1 (RUN) Cycle time = 1.25 * value	RO	0 _{hex}
FEA0:15	Actual Safety Control Task Execution Time	Current execution time of the TwinSAFE logic with a logic state of <> 1 Cycle time = 1.25 * value (average value of 64 cycles)	RO	0 _{hex}
FEA0:16	Min Safety Control Task Execution Time	Minimum execution time of the TwinSAFE logic with a logic state of <> 1 Cycle time = 1.25 * value	RO	0 _{hex}
FEA0:17	Max Safety Control Task Execution Time	Maximum execution time of the TwinSAFE logic with a logic state of <> 1 Cycle time = 1.25 * value	RO	0 _{hex}



Resetting the values

The max. and min. values can be reset by writing a value to the CoE object 0x1C32:08.

5.5.7 Diag History tab

All errors occurring within the TwinSAFE components are stored in their diag history. The diag history can be viewed by selecting the corresponding TwinSAFE component in the I/O tree structure and then selecting the *Diag History* tab. Use the *Update History* button to fetch the current data from the TwinSAFE component. Errors within the logic, the function blocks, the connections or the component itself are stored with a corresponding time stamp.

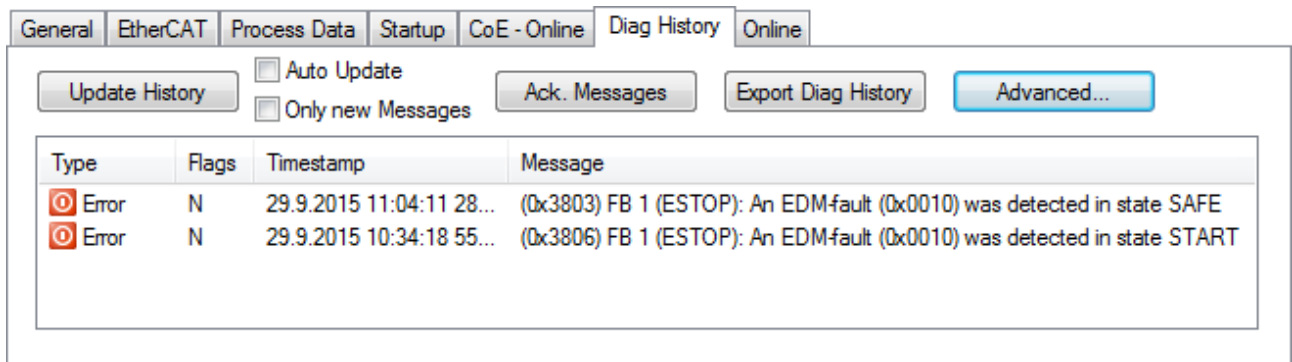

Fig. 29: Diag history

Use the *Advanced...* button to open the advanced settings. Here, the user can customize the behavior of the diag history.

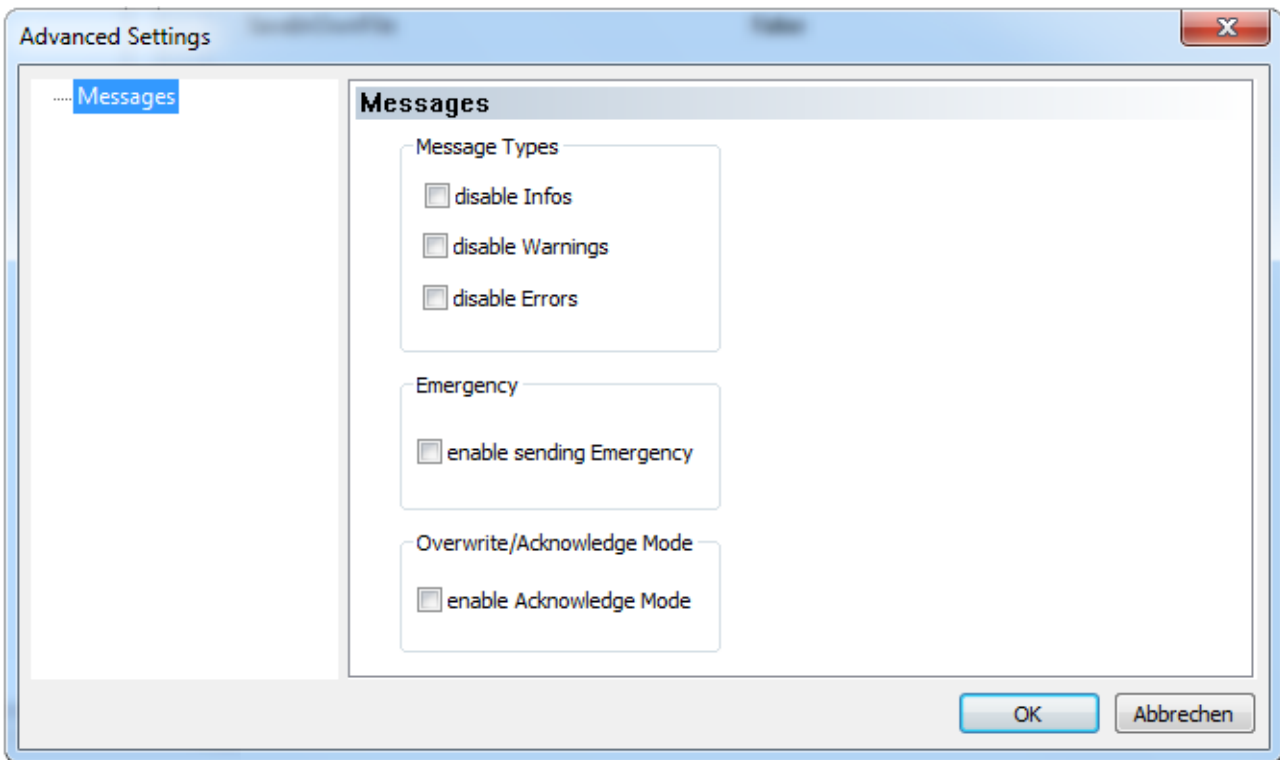

Fig. 30: Diag history – advanced settings

Advanced Settings

Setting	Description
Message Types	<ul style="list-style-type: none"> • disable Info Messages with the <i>Info</i> status are not saved in the diag history • disable Warnings Messages with the <i>Warning</i> status are not saved in the diag history • disable Errors Messages with the <i>Error</i> status are not saved in the diag history
Emergency	In addition to saving the message in the diag history, an emergency object is also sent and displayed in the TwinCAT logger window.
Overwrite / Acknowledge Mode	This setting is currently not supported.

5.5.8 Diagnosis History

The diagnostic history of the TwinSAFE devices that support this function is implemented in accordance with the ETG guideline ETG.1020 Chapter 13 "Diagnosis Handling". The diagnostic messages are saved by the TwinSAFE device in a dedicated CoE object under 0x10F3 and can be read out by the application or by TwinCAT.

Both the control entries and the history itself can be found in the CoE object 0x10F3. The entry Newest Message (0x10F3:02) contains the subindex of 0x10F3, which contains the latest diagnostic message, e.g. 0x06 for diagnostic message 1.

Index 10F3_{hex} Diagnosis History

Index (hex)	Name	Meaning	Data type	Flags	Default
10F3:0	Diagnosis History				

Index (hex)	Name	Meaning	Data type	Flags	Default
10F3:01	Maximum Messages	Maximum number of stored messages. A maximum of 64 messages can be stored. After that the respective oldest messages are overwritten.	UINT8	RO	0x40 (64 _{dec})
10F3:02	Newest Message	Subindex of the latest message	UINT8	RO	0x00 (0 _{dec})
10F3:03	Newest Acknowledged Message	Subindex of the last confirmed message	UINT8	RW	0x00 (0 _{dec})
10F3:04	New Messages Available	Indicates that a new message is available	BOOLEAN	RO	0x00 (0 _{dec})
10F3:05	Flags	Set via the startup list. If set to 0x0001, the diagnostic messages are additionally sent by emergency to the EtherCAT master	UINT16	RW	0x0000 (0 _{dec})
10F3:06	Diagnosis Message 001	Diagnosis message 1	BYTE[32]	RO	{0}
...
10F3:45	Diagnosis Message 064	Diagnosis message 64	BYTE[32]	RO	{0}

Structure of the diagnosis messages

- DiagCode (4 bytes) – in this case always 0x 0000 E000
- Flags (2 bytes) - diagnosis type (info, warning or error), time stamp and number of parameters contained (see the following table)
- Text ID (2 bytes) – ID of the diagnosis message as a reference to the message text from the ESI/XML
- Time stamp (8 bytes) – local slave time in ns since switching on the TwinSAFE device
- dynamic parameters (16 bytes) – parameters that can be inserted in the message text (see following table)

Flags in diagnosis messages

Data type	Offset	Description	
UINT16	Bit 0...3	DiagType (value)	
		0	Info message
		1	Warning message
		2	Error message
		3...15	reserved
	Bit 4	If the bit = 1, the time stamp contained in the message is the local time stamp of the TwinSAFE device. The age of the diagnosis message can be deduced by calculation with the current time stamp from the CoE object 0x10F8.	
	Bit 5...7	reserved	
	Bit 8...15	Number of parameters in this diagnosis message	

Dynamic parameters in the diagnosis messages

Type	Data type	Description
Flags parameter 1	UINT16	Describes the type of parameter 1
		Bit 12...15 = 0 Bit 0...11 = data type of parameter 1 0x0001 - BOOLEAN 0x0002 - INT8 0x0003 - INT16 0x0004 - INT32 0x0005 - UINT8

Type	Data type	Description
		0x0006 - UINT16 0x0007 - UINT32 0x0008 - REAL32 0x0011 - REAL64 0x0015 - INT64 0x001B - UINT64 Text parameters and formats are specified in ETG.2000.
Parameter 1	Data type in accordance with flags	Value of parameter 1
Flags parameter 2	UINT16	see Flags parameter 1
Parameter 2	Data type in accordance with flags	Value of parameter 2
...		

The diagnostic messages are saved in text form in the ESI/XML file belonging to the TwinSAFE device. On the basis of the Text ID contained in the diagnostic message, the corresponding plain text message can be found in the respective languages. The parameters can be inserted in the appropriate positions. In the following example, %x is used for a hexadecimal representation of the parameters.



Fig. 31: ESI/XML message text

Via the entry *New Messages Available* the user receives information that new messages are available. The messages can be read out via CompleteAccess (a CoE read command for the complete CoE object 0x10F3). The *New Messages Available* bit is reset after reading the messages.

The sending of emergency messages to the EtherCAT master is activated by adding the CoE object 0x10F3:05 to the startup list (Transition IP, value 0x0001). If new diagnostic messages arrive, they are entered in object 0x10F3 and additionally sent by emergency to the EtherCAT master.

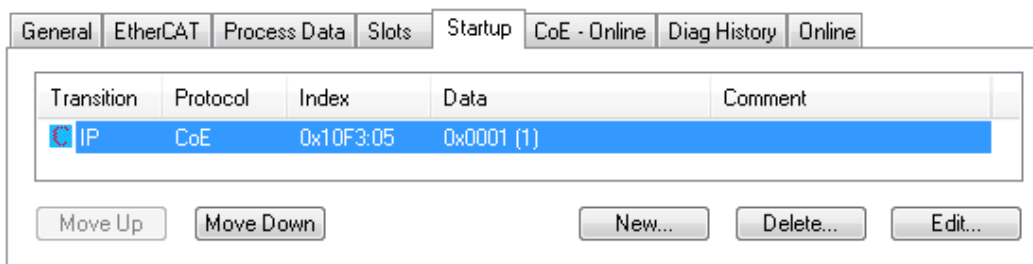

Fig. 32: Startup list

6 Service life

The TwinSAFE EtherCAT Boxes have a service life of 20 years.

Due to the high diagnostic coverage within the lifecycle no special proof tests are required.

Date code

The TwinSAFE EtherCAT Boxes have a date code (D:), which is structured as follows:

Date code: WW YY SW HW

Key:	Example: Date code 16 18 01 02
WW: Calendar week of manufacture	Calendar week: 16
YY: Year of manufacture	Year: 2018
SW: Software version	Software version: 01
HW: Hardware version	Hardware version: 02

Serial number (S. no.)

In addition, the TwinSAFE EtherCAT Boxes have a unique serial number (S. no.).

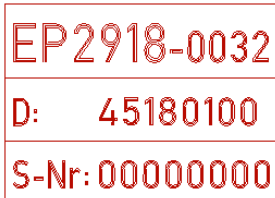

Fig. 33: EP2918 serial number and data code

7 Maintenance and cleaning

● Cleaning by the manufacturer only



Do not operate the TwinSAFE component if it is impermissibly dirty according to protection class IP20. Send impermissibly dirty TwinSAFE components to the manufacturer for cleaning.

TwinSAFE components are basically maintenance-free.

8 Decommissioning

8.1 Disposal

NOTE

Correct disposal

Observe the applicable national laws and guidelines for disposal.

Incorrect disposal may result in environmental damage.

Remove the TwinSAFE component for disposal.

Depending on your application and the products used, make sure that the respective components are disposed of properly:

Cast iron and metal

Hand over cast iron and metal parts to scrap metal recycling.

Cardboard, wood and polystyrene

Dispose of packaging materials made of cardboard, wood or Styrofoam in accordance with regulations.

Plastic and hard plastic

You can recycle parts made of plastic and hard plastic via the waste management center or reuse them in accordance with the component regulations and markings.

Oils and lubricants

Dispose of oils and lubricants in separate containers. Hand over containers to the waste oil collection point.

Batteries and accumulators

Batteries and accumulators may also be marked with the crossed-out wheeled garbage can symbol. You must separate these components from waste. You are legally obliged to return used batteries and accumulators within the EU. Outside the validity of the EU Directive 2006/66/EC, observe the respective regulations.

8.1.1 Returning to the vendor

In accordance with the WEEE-2012/19/EU directives, you can return used devices and accessories for professional disposal. The transport costs are borne by the sender.

Send the used devices with the note "For disposal" to:

Beckhoff Automation GmbH & Co. KG
Gebäude „Service“
Stahlstraße 31
D-33415 Verl

In addition, you have the option to contact a local certified specialist company for the disposal of used electrical and electronic appliances. Dispose of the old components in accordance with the regulations applicable in your country.

9 Appendix

9.1 Protection classes according to IP code

The levels of protection are defined and divided into different classes in the IEC 60529 standard (DIN EN 60529). The designation follows the scheme below.

1st digit: Protection against ingress of dust and access to hazardous parts

1 st digit	Meaning
0	Non-protected
1	Protection against access to hazardous parts with back of hand. Protection against ingress of solid foreign objects = 50 mm diameter
2	Protection against access to hazardous parts with a finger. Protection against ingress of solid foreign objects = 12.5 mm diameter
3	Protection against access to hazardous parts with a tool. Protection against ingress of solid foreign objects = 2.5 mm diameter
4	Protection against access to hazardous parts with a wire. Protection against ingress of solid foreign objects = 1 mm diameter
5	Protection against access to hazardous parts with a wire. Protection against ingress of dust. Ingress of dust is not prevented completely, although the quantity of dust able to penetrate is limited to such an extent that the proper function of the device and safety are not impaired
6	Protection against access to hazardous parts with a wire. Dust-proof. No ingress of dust

2nd digit: Protection against ingress of water*

2 nd digit	Meaning
0	Non-protected.
1	Protection against dripping water.
2	Protection against dripping water when housing tilted up to 15°.
3	Protection against spraying. Water sprayed at an angle of up to 60° from vertical must not have any adverse effect.
4	Protection against splashing. Water splashing against the housing from any direction must not have any adverse effects.
5	Protection against jetting.
6	Protection against powerful jetting.
7	Protection against the effects of temporary immersion. The quantity of water being able to penetrate if the housing is submerged in water for 30 minutes at a depth of 1 m must not have any adverse effects.

*) These protection classes only define protection against water, not against other liquids.

9.2 Volatility

If there are requirements concerning the volatility of products in your application, for example of the U.S. Department of Defense or similar authorities or security organizations, the following process applies:

The product has both volatile and non-volatile components. Volatile components lose their data immediately after removing power. Non-volatile components keep the data even after loss of power.

If there is customer specific data saved on the product, it cannot be ensured that this data might not be restored through for example forensic measures, even after the data is deleted through the provided tool chain. If this data is confidential, the scrapping of the product after usage is recommended to protect this data.

9.3 Focus of certificates

The most decisive document for certified components of the TwinSAFE department is the EC type examination certificate. The document contains both the test coverage and the regarded component and component family.

The current certificates of all TwinSAFE components with the underlying standards and directives can be found at <https://www.beckhoff.com/en-en/support/download-finder/certificates-approvals/>.

If the document refers only to the first four figures of a product (ELxxxx), the certificate is valid for all available variants of the component (ELxxxx-abcd). This is applicable for all components like EtherCAT Terminals, EtherCAT Boxes, EtherCAT plug-in modules and Bus Terminals.

CERTIFICADO ◆ CERTIFICADO ◆ СЕРТИФИКАТ ◆ СЕРТИФИКАТ ◆ 書	
	<h1>EC-Type Examination Certificate</h1> <p>No. M6A 062386 0055 Rev. 01</p>
	<p>Holder of Certificate: Beckhoff Automation GmbH & Co. KG Hülshorstweg 20 33415 Verl GERMANY</p>
	<p>Product: Safety components</p>
	<p>Model(s): EL1918</p>
<p>Parameters:</p> <p>Supply voltage: 24VDC (-15%/+20%) Ambient temperature: -25°C...+55°C Protection class: IP20</p>	
<p>This EC Type Examination Certificate is issued according to Article 12(3) b or 12(4) a of Council Directive 2006/42/EC relating to machinery. It confirms that the listed Annex-IV equipment complies with the principal protection requirements of the directive. It refers only to the sample submitted to TÜV SÜD Product Service GmbH for testing and certification. For details see: www.tuvsud.com/ps-cert</p>	
<p>Test report no.:</p>	<p>BV99670C</p>

If you regard the example EL1918 in the picture, the certificate is valid for both the EL1918 and the available variant EL1918-2200.

9.4 Certificate

BECKHOFF New Automation Technology		Originalerklärung Original declaration
EG-Konformitätserklärung EC Declaration of Conformity		
Nummer: 20200068EP2918-2, Datum: 16.11.2022 <i>Number, Date</i>		
Hersteller <i>Manufacturer</i>	Beckhoff Automation GmbH & Co. KG Hülshorstweg 20, 33415 Verl, Germany	
erklärt, dass das Produkt <i>declares that the product</i>	TwinSAFE EP2918 TwinSAFE-EtherCAT-Box mit 8 sicheren Ausgängen, 24V DC <i>TwinSAFE-EtherCAT-Box with 8 safe outputs, 24V DC</i>	
den Bestimmungen der folgenden EG-Richtlinien entspricht: <i>complies with the relevant requirements of the following EC directives:</i>		
2006/42/EG <i>2006/42/EC</i>	Richtlinie 2006/42/EG des Europäischen Parlaments und des Rates vom 17. Mai 2006 über Maschinen und zur Änderung der Richtlinie 95/16/EG (Neufassung) <i>Directive 2006/42/EC of the European Parliament and of the Council of 17 May 2006 on machinery, and amending Directive 95/16/EC (recast)</i>	
2011/65/EU <i>2011/65/EU</i>	Richtlinie 2011/65/EU des Europäischen Parlaments und des Rates vom 8. Juni 2011 zur Beschränkung der Verwendung bestimmter gefährlicher Stoffe in Elektro- und Elektronikgeräten <i>Directive 2011/65/EU of the European Parliament and of the Council of 8 June 2011 on the restriction of the use of certain hazardous substances in electrical and electronic equipment (recast)</i>	
2014/30/EU <i>2014/30/EU</i>	Richtlinie 2014/30/EU des Europäischen Parlaments und des Rates vom 26. Februar 2014 zur Harmonisierung der Rechtsvorschriften der Mitgliedstaaten über die elektromagnetische Verträglichkeit (Neufassung) <i>Directive 2014/30/EU of the European Parliament and of the Council of 26 February 2014 on the harmonisation of the laws of the Member States relating to electromagnetic compatibility (recast)</i>	
Die Konformität mit den Bestimmungen der genannten Richtlinien wird durch Einhaltung der folgenden Normen nachgewiesen: <i>The conformity with the listed directives is proved by compliance with the following standards:</i>		
EN ISO 13849-1:2015 EN 62061:2005/A2:2015	EN IEC 63000:2018	EN 61000-6-2:2005 EN 61000-6-4:2007 EN 61131-2:2007
Die Übereinstimmung eines Baumusters des bezeichneten Produkts mit den EU-Richtlinien wurde bescheinigt von <i>The accordance of a production sample of the designated product with the EC directives is certified by</i>		
Richtlinie <i>Directive</i>	Benannte Stelle <i>Notified Body</i>	Baumusterprüfbescheinigung <i>type examination certificate</i>
2006/42/EG <i>2006/42/EC</i>	TÜV SÜD Product Service GmbH Ridlerstraße 65, 80339 München, Germany	M6A 062386 0068 Rev. 01 2022-11-10
Verantwortlich für die Zusammenstellung der technischen Unterlagen <i>Responsible for the compilation of technical documentation</i>		
Bevollmächtigter <i>Authorised person</i>	Beckhoff Automation GmbH & Co. KG Hülshorstweg 20, 33415 Verl, Germany	
Verl, 12.11.2022		
Ort / Datum <i>Place / Date</i>	Dipl.-Phys. Hans Beckhoff, Geschäftsführer <i>Dipl.-Phys. Hans Beckhoff, CEO</i>	

Fig. 34: EP2918 EC Declaration of Conformity

List of illustrations

Fig. 1	EtherCAT Box modules extend the EtherCAT system with IP67 protection	14
Fig. 2	EP2918 – TwinSAFE EtherCAT Box with 8 fail-safe outputs.....	15
Fig. 3	Dimensions	19
Fig. 4	EtherCAT Box with M8 plug connectors	22
Fig. 5	EtherCAT Box with M8 and M12 connectors	22
Fig. 6	7/8" plug connectors.....	22
Fig. 7	Torque wrench ZB8801.....	22
Fig. 8	EtherCAT connection 30 mm housing M8	23
Fig. 9	Safe outputs 1 to 8.....	26
Fig. 10	PinOut safe output	26
Fig. 11	Signal lines.....	28
Fig. 12	Cable routing.....	29
Fig. 13	Inserting an EP2918.....	30
Fig. 14	EP2918 - Delete Project Data.....	31
Fig. 15	EtherCAT Box - Rotary switches on the underside.....	32
Fig. 16	Starting the automatic import from the I/O configuration.....	33
Fig. 17	Selection from the I/O tree	33
Fig. 18	Creating alias devices by the user	34
Fig. 19	EP2918 – Linking tab	35
Fig. 20	EP2918 - Connection tab.....	36
Fig. 21	EP2918 - Parameters.....	37
Fig. 22	EP2918 Process image.....	38
Fig. 23	Typical response time	39
Fig. 24	Worst case response time.....	40
Fig. 25	EP2918 Diagnostic LEDs.....	41
Fig. 26	EP2918 Status LEDs	42
Fig. 27	EP2918 - Diagnostic LEDs.....	43
Fig. 28	Diagnostic object - FSLOGIC Status (F100hex) in the process image of the TwinSAFE component	45
Fig. 29	Diag history	46
Fig. 30	Diag history – advanced settings	47
Fig. 31	ESI/XML message text.....	49
Fig. 32	Startup list	49
Fig. 33	EP2918 serial number and data code.....	50
Fig. 34	EP2918 EC Declaration of Conformity.....	56

More Information:
www.beckhoff.com/EP2918-0032

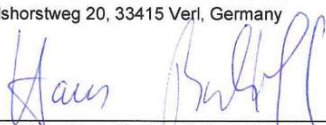
Beckhoff Automation GmbH & Co. KG
Hülshorstweg 20
33415 Verl
Germany
Phone: +49 5246 9630
info@beckhoff.com
www.beckhoff.com

